

VEO-XCTRLG2

VIDEO DISTRIBUTION OVER IP

H.265 Full HD over IP Video Extender Controller



PRECAUTIONS

PACKAGE CONTENTS

DESCRIPTION & FEATURES

INSTALL & CONNECT

START-UP & OPERATION

PANEL FUNCTIONS

TECHNICAL DATA

USER MANUAL

TABLE OF CONTENTS

| | |
|---|-----------|
| 1. PRECAUTIONS | 3 |
| 1.1 Important Remark | 3 |
| 1.2 Important Safety Instructions..... | 4 |
| 1.3 Cleaning | 4 |
| 2. PACKAGE CONTENTS | 5 |
| 3. DESCRIPTION AND FEATURES | 5 |
| 3.1 Main Features..... | 6 |
| 4. INSTALL & CONNECT..... | 7 |
| 4.1 Rack mounting..... | 7 |
| 4.2 Connection Diagram | 8 |
| 4.3 Network Requirements and Configuration..... | 8 |
| 4.3.1 Web Connection and Settings..... | 9 |
| 4.4 Configuration Using Web Interface..... | 9 |
| 4.4.1 Wizard Setup..... | 10 |
| 5. START-UP and OPERATION | 14 |
| 5.1 Web Functions and Operation | 14 |
| 5.1.1 Preview..... | 14 |
| 5.1.2 Matrix Control | 14 |
| 5.1.3 Videowall Control..... | 15 |
| 5.1.4 Project..... | 16 |
| 5.1.5 Encoders (Transmitters)..... | 17 |
| 5.1.6 Decoders (Receivers) | 19 |
| 5.1.7 Linked Signal Routing..... | 21 |
| 5.1.8 Videowall Management..... | 23 |
| 5.1.9 Users..... | 26 |
| 5.1.10 Controller Settings | 27 |
| 5.1.11 Firmware Update..... | 31 |
| 5.1.12 Password Update..... | 32 |
| 5.1.13 Log out..... | 32 |
| 6. PANEL FUNCTIONS | 33 |
| 6.1 Front Panel..... | 33 |
| 6.2 Rear Panel..... | 33 |
| 7. TECHNICAL DATA | 34 |
| 7.1 Technical Specifications..... | 34 |
| 7.2 Mechanical Diagram..... | 35 |

| |
|---|
|  |
| PRECAUTIONS |
| PACKAGE CONTENTS |
| DESCRIPTION & FEATURES |
| INSTALL & CONNECT |
| START-UP & OPERATION |
| PANEL FUNCTIONS |
| TECHNICAL DATA |

1. PRECAUTIONS

1.1 IMPORTANT REMARK



WARNING: SHOCK HAZARD - DO NOT OPEN

AVIS: RISQUE DE CHOC ÉLECTRIQUE - NE PAS OUVRIR



The lightning flash with arrowhead symbol, within an equilateral triangle, is intended to alert the user to the presence of uninsulated “dangerous voltage” within the product’s enclosure that may be of sufficient magnitude to constitute a risk of electric shock to persons.



The exclamation point within an equilateral triangle is intended to alert the user to the presence of important operating and maintenance (servicing) instructions in the literature accompanying the appliance.

WARNING (If applicable): The terminals marked with symbol of “⚡” may be of sufficient magnitude to constitute a risk of electric shock. The external wiring connected to the terminals requires installation by an instructed person or the use of ready-made leads or cords.

WARNING: To prevent fire or shock hazard, do not expose this equipment to rain or moisture.

WARNING: A device with Class I construction shall be connected to a mains socket-outlet with a protective earthing connection.



WARNING: This product must not be discarded, under any circumstance, as unsorted urban waste. Take to the nearest electrical and electronic waste treatment centre.



This equipment has been tested and found to comply with the limits for a Class A digital device, pursuant to part 15 of the FCC Rules. These limits are designed to provide reasonable protection against harmful interference when the equipment is operated in a commercial environment. This equipment generates, uses, and can radiate radio frequency energy and, if not installed and used in accordance with the instruction manual, may cause harmful interference to radio communications. Operation of this equipment in a residential area is likely to cause harmful interference in which case the user will be required to correct the interference at his own expense.



PRECAUTIONS

PACKAGE CONTENTS

DESCRIPTION & FEATURES

INSTALL & CONNECT

START-UP & OPERATION

PANEL FUNCTIONS

TECHNICAL DATA

1.2 IMPORTANT SAFETY INSTRUCTIONS

1. Read these instructions.
2. Keep these instructions.
3. Heed all warnings.
4. Follow all instructions.
5. Do not use this device near water.
6. Clean only with dry cloth.
7. Do not block any ventilation openings. Install in accordance with the manufacturer's instructions.
8. Do not install near any heat sources such as radiators, heat registers, stoves, or other device (including amplifiers) that produce heat.
9. Do not defeat the safety purpose of the polarized or grounding type plug. A polarized plug has two blades with one wider than the other. A grounding type plug has two blades and a third grounding prong. The wide blade or the third prong are provided for your safety. If the provided plug does not fit into your outlet, consult an electrician for replacement of the obsolete outlet.
10. Protect the power cord from being walked on or pinched particularly at the plugs, convenience receptacles, and at the point where they exit from the device.
11. Only use attachments/accessories specified by the manufacturer.
12. Unplug the device during lightening sorts or when unused for long periods of time.
13. Refer all servicing to qualified personnel. Servicing is required when the device has been damaged in any way, such as power supply cord or plug is damaged, liquid has been spilled or objects have fallen into the device, the device has been exposed to rain or moisture, does not operate normally, or has been dropped.
14. Disconnecting from mains: When switching off the POWER switch, all the functions and light indicators of the unit will be stopped, but fully disconnecting the device from mains is done by unplugging the power cable from the mains input socket. For this reason, it always shall remain easily accessible.
15. Equipment is connected to a socket-outlet with earthing connection by means of a power cord.
16. The marking information is located at the bottom of the unit.
17. The device shall not be exposed to dripping or splashing and that no objects filled with liquids, such as vases, shall be placed on device.

1.3 CLEANING



Clean the unit with a soft, dry clean cloth or slightly wet with water and neutral liquid soap only, then dry it with a clean cloth. Be careful that water never gets into the unit through any hole. Never use alcohol, benzine, solvents or abrasive substances to clean this unit.

NEEC AUDIO BARCELONA, S.L. accepts no liability for any damage that may be caused to people, animal, or objects due to failure to comply with the warnings above.

| |
|---|
|  |
| PRECAUTIONS |
| PACKAGE CONTENTS |
| DESCRIPTION & FEATURES |
| INSTALL & CONNECT |
| START-UP & OPERATION |
| PANEL FUNCTIONS |
| TECHNICAL DATA |

**Thank you for choosing our device Ecler VEO-XCTRLG2!
We appreciate your trust.**

It is **VERY IMPORTANT** to carefully read this manual and to fully understand its contents before any connection in order to maximize your use and get the best performance from this equipment.

To ensure optimal operation of this device, we strongly recommend that its maintenance be carried out by our authorised Technical Services.

All ECLER products are covered by warranty, please refer to www.ecler.com or the warranty card included with this product for the period of validity and conditions.

2. PACKAGE CONTENTS

- 1 x Video over IP Controller
- 1 x 20kHz-60kHz 12V IR Receiver.
- 1 x 3-pin Euroblock Connector
- 1 x 6-pin Euroblock Connector
- 2 x Mounting Ears
- 4 x Machine Screws (KM3*6)
- 1 x 12V/1A Locking Power Adaptor
- 1 x Getting Started Guide.
- 1 x Warranty card

3. DESCRIPTION AND FEATURES

VEO-XCTRLG2 is a controller module that allows the user to manage and operate VEO-XTI1CG2 and VEO-XRI1CG2 video over IP devices in large multipoint to multipoint systems. It mounts two dedicated LAN ports to host independent Control and Video networks. VEO-XCTRLG2 offers a dedicated web interface that features a setup wizard, matrix control, videowall smart creation and operation, drag and drop source selection, video preview and TCP and RS-232 control commands. It supports POE function which makes this advanced managing tool a perfect fit more all sorts of AV over IP installations.

| |
|---|
|  |
| PRECAUTIONS |
| PACKAGE CONTENTS |
| DESCRIPTION & FEATURES |
| INSTALL & CONNECT |
| START-UP & OPERATION |
| PANEL FUNCTIONS |
| TECHNICAL DATA |

3.1 MAIN FEATURES

- Easy to create project, control and manage the system.
- Setup wizard to easy assign devices to a project including Auto, DHCP and Manual IP configurations.
- HTTPS, SSH, SFTP security compatible.
- Built-in Web GUI control interface, supporting Drag & Drop operations.
- Support image preview.
- Support video, audio, RS-232, control and management of the distributed system.
- Two dedicated LAN ports to host independent Control and Video networks.
- Support TCP and RS-232 port control and third-party central control.
- Multiple circuits protection, lightning protection and ESD design.
- Reliable system design, ensuring 7*24 hours reliable and stable work.
- PoE functionality.

| |
|---|
|  |
| PRECAUTIONS |
| PACKAGE CONTENTS |
| DESCRIPTION & FEATURES |
| INSTALL & CONNECT |
| START-UP & OPERATION |
| PANEL FUNCTIONS |
| TECHNICAL DATA |

4. INSTALL & CONNECT

4.1 RACK MOUNTING

This product can be mounted in a standard rack.

1. Stack two products on top of each other. Then use the included screws to fix two 1U mounting ears on the products.



2. Place two pairs of products together with each other using the provided screws.

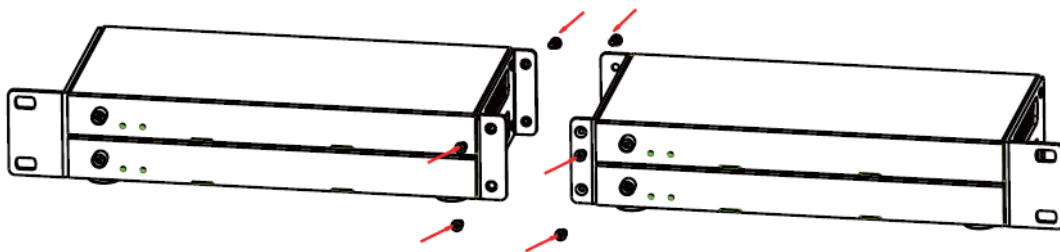

3. Fasten screws between each pair to mount four products together.

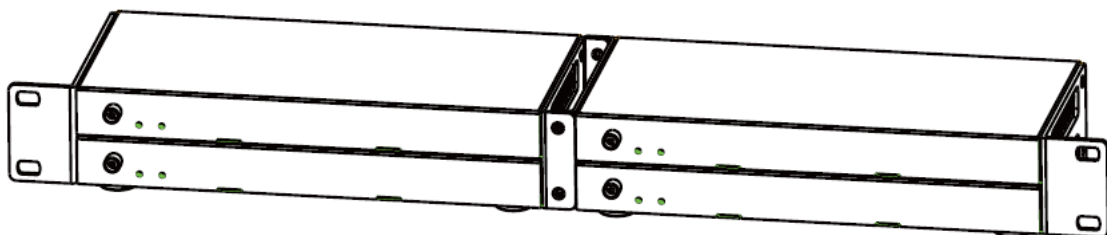

PRECAUTIONS

PACKAGE CONTENTS

DESCRIPTION & FEATURES

INSTALL & CONNECT

START-UP & OPERATION

PANEL FUNCTIONS

TECHNICAL DATA

4.2 CONNECTION DIAGRAM

In a **typical configuration** the devices are connected like follows:

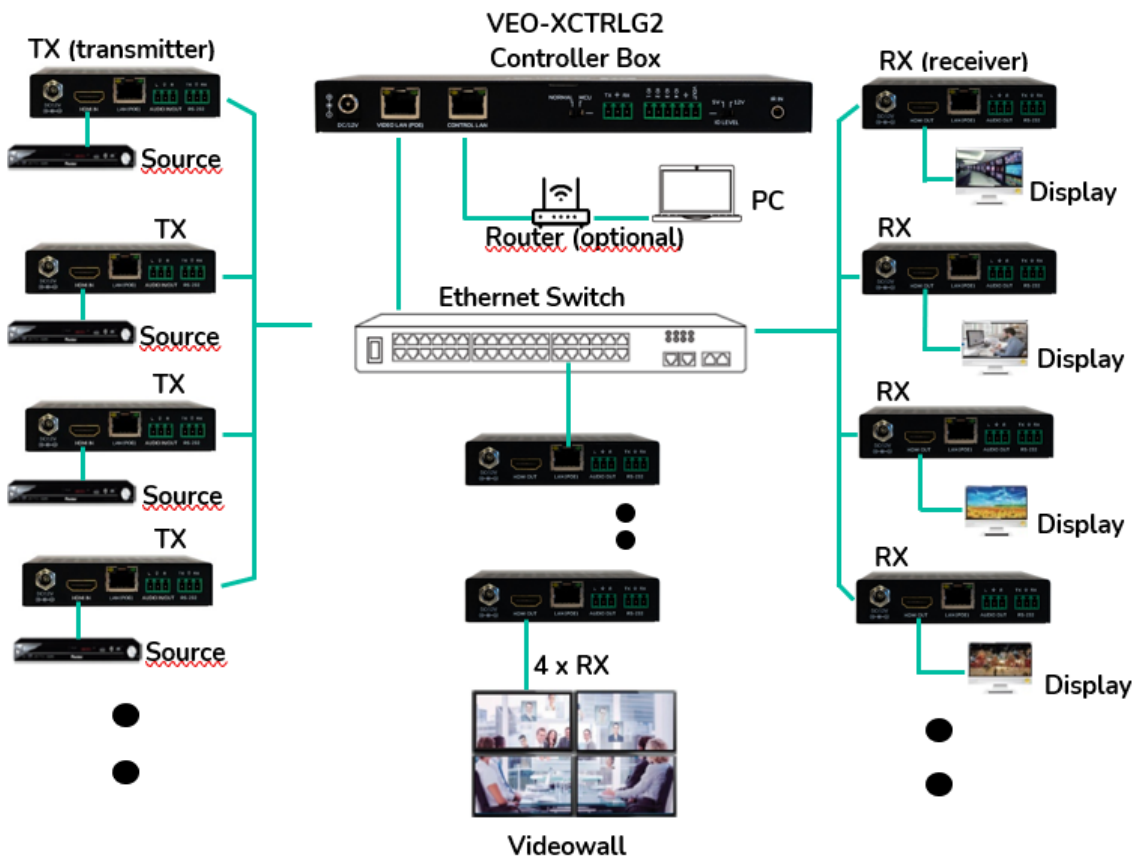

! When the Network Switch does not support PoE, then VEO-XTI1CG2, VEO-XRI1CG2 and VEO-XCTRLG2, should be powered by the included DC power adapter.

4.3 NETWORK REQUIREMENTS AND CONFIGURATION

VEO-XCTRLG2, is not limited to certain brands of network hardware, but the **network must support the following features:**

- Type of layer 3 managed network switch
- Support and enable IGMP snooping and the adequate multicast filtering.

! In order to prevent malfunctioning, interference or drop in signal performance due to other network products bandwidth requirements or network design, it is highly recommended to **check with the chosen network IT staff how to properly set the Multicast products connected to the local network switch.**

💡 One of the advantages in the use of VEO-XCTRLG2 is the **possibility to separate the Video Network to the Control Network.** In this way, the consistent multicast traffic generated by the video over IP extenders can be isolated from the control traffic generated by the embedded or by the third-party control system. We can think of VEO-XCTRLG2 as **a gateway between the control network and the video network.**

| |
|------------------------|
| PRECAUTIONS |
| PACKAGE CONTENTS |
| DESCRIPTION & FEATURES |
| INSTALL & CONNECT |
| START-UP & OPERATION |
| PANEL FUNCTIONS |
| TECHNICAL DATA |

4.3.1 WEB CONNECTION AND SETTINGS.

The default IP address of VEO-XCTRLG2 for its Control Port is 192.168.0.225 if there is no DHCP server in the system.

 Once a VEO-XCTRLG2 is connected to a network with other VEO-XTI1CG2 and VEO-XRI1CG2, the controller will act as manager of the network and will automatically assign addresses to the various devices.

4.4 CONFIGURATION USING WEB INTERFACE

VEO-XCTRLG2 can be configured through its own built-in web interface which can be accessed through the following two methods:

- Typing the chosen or the default IP address of the device (192.168.0.225 if no DHCP server is used) in the web browser search tab.
- Typing the URL “controller.local” (this tag can be customized. For details, [see chapter Controller Settings](#)).



The default credentials to log in are:

- User name: admin
- Password: 1234

| |
|---|
|  |
| PRECAUTIONS |
| PACKAGE CONTENTS |
| DESCRIPTION & FEATURES |
| INSTALL & CONNECT |
| START-UP & OPERATION |
| PANEL FUNCTIONS |
| TECHNICAL DATA |

4.4.1 WIZARD SETUP

Once logged in, **if there's no existing project, this message will appear to help the user to configure the system** through the wizard procedure.

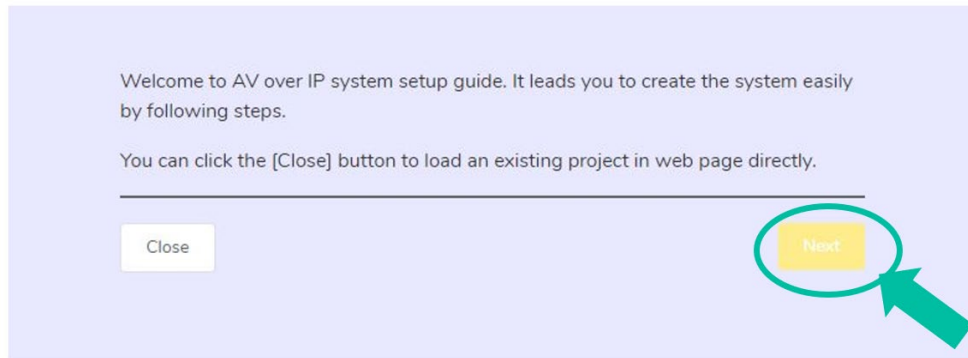

Then **click Next** to advance to the next page.

 If the system has already been configured previously, **clicking “Close” will take the user directly to the system control page.**

4.4.1.1 AUTOMATICALLY MANAGED BY CONTROLLER BOX

Select this option and once the IP address management settings have been selected, **the controller will proceed to scan for devices in the VIDEO network.**

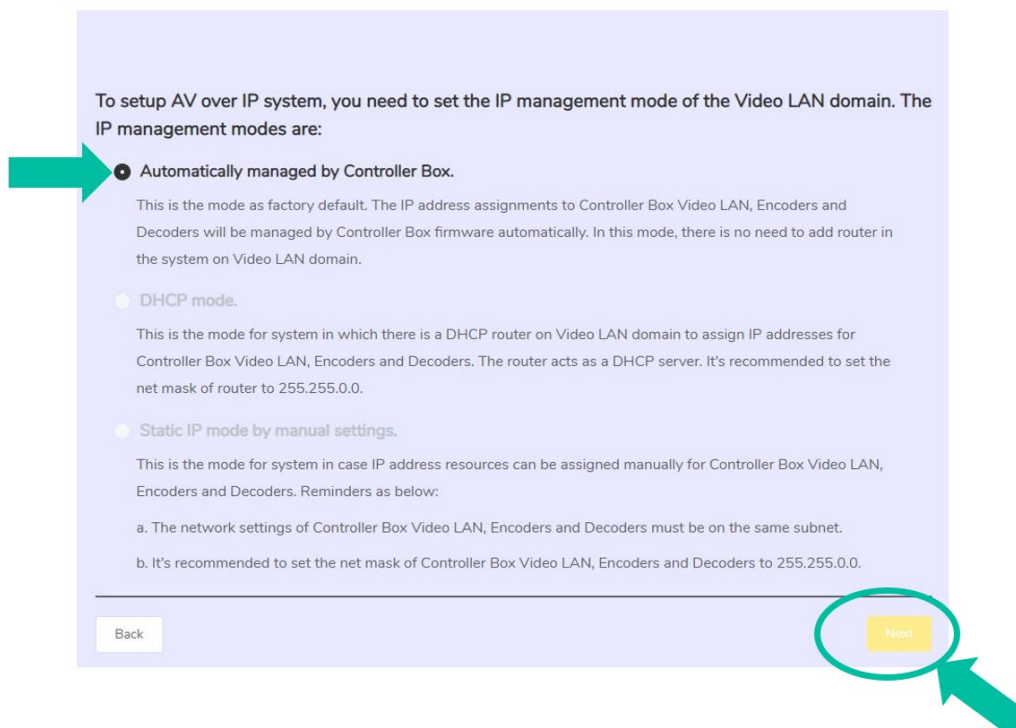

Then **click Next** to advance to the next page.

| |
|---|
|  |
| PRECAUTIONS |
| PACKAGE CONTENTS |
| DESCRIPTION & FEATURES |
| INSTALL & CONNECT |
| START-UP & OPERATION |
| PANEL FUNCTIONS |
| TECHNICAL DATA |

It will then be possible to decide whether to add all the connected devices to the new project (brand new installation) or to add them selectively in case of changes to an existing system.

1. If you select “Automatically add Encoders and Decoders to Project” and click the “Scan” button to enter the Project page.

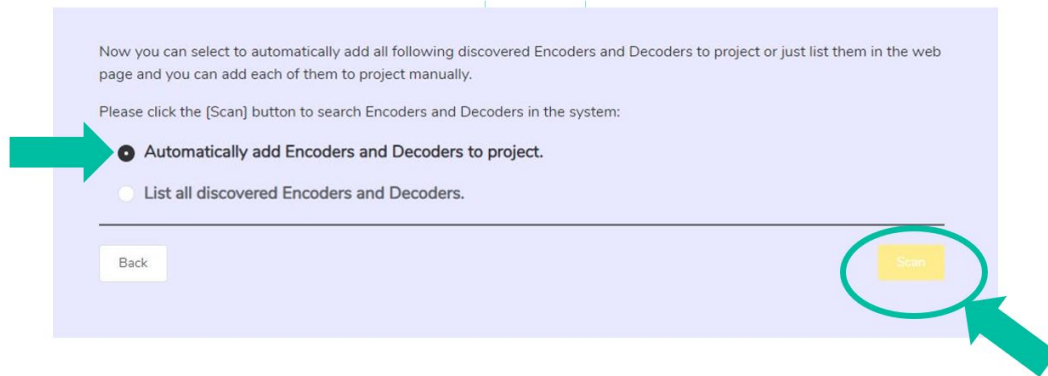

All the connected devices will be listed in the Current Devices list.
Then click “Stop Scan & Auto Assign” to stop search.

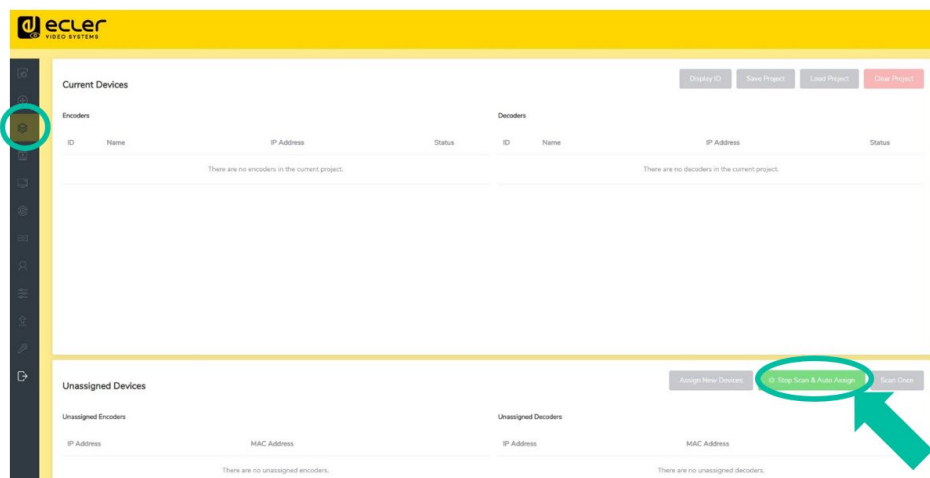

2. If you select “List all discovered Encoders and Decoders” in the wizard windows and click the “Scan” button to enter the Project page, all the connected devices will be listed in the Unassigned Devices list.

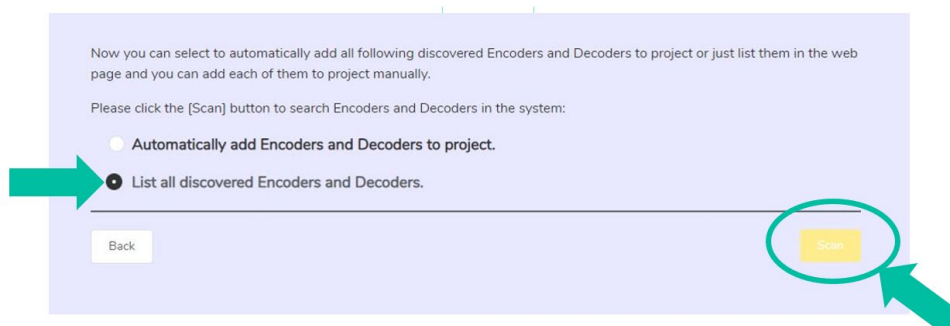



Click “Stop Scan” to stop search. Then the “Add All” buttons and “Add” buttons behind Unassigned Transmitters and Unassigned Receivers **will become operational**. At this time, you can **click the “Add” button** behind each unregistered Transmitter or Receiver **to add the device to the project one by one or click the “Add All” button to add all Transmitters or Receivers to the project**.

Transmitters and Receivers that have been added to the project **will appear in the Current Devices list**.

4.4.1.2 DHCP MODE

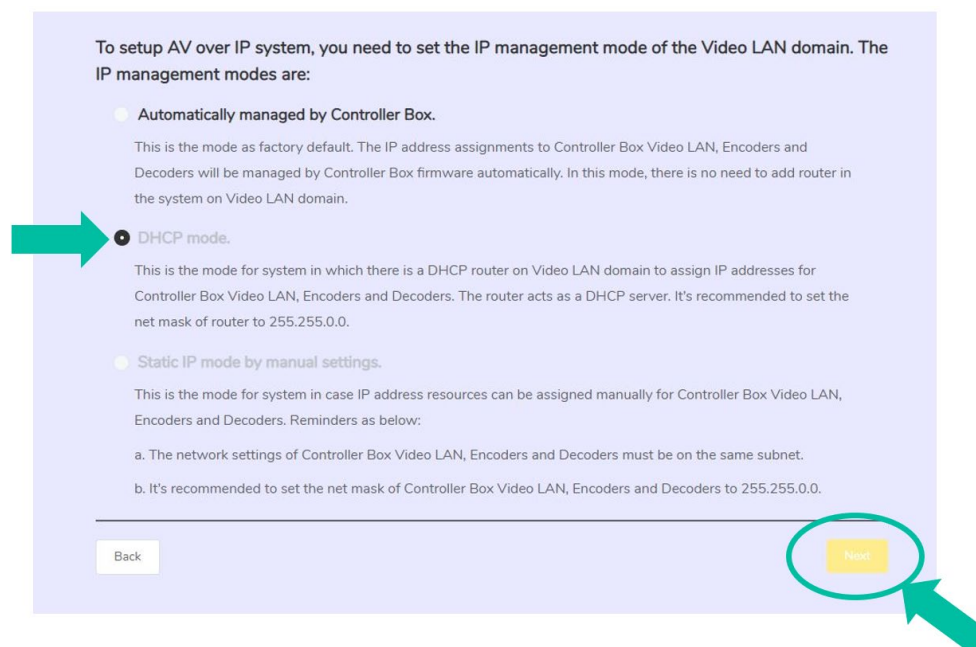
The procedure is identical to the previous one, with the only difference that in this case **the IP addresses are assigned by a DHCP server**.



 There will be no need to set up the **Video LAN port settings of the VEO-XCTRLG2 controller box in Auto or DHCP as they will be automatically configured by the controller**.

- PRECAUTIONS
- PACKAGE CONTENTS
- DESCRIPTION & FEATURES
- INSTALL & CONNECT
- START-UP & OPERATION
- PANEL FUNCTIONS
- TECHNICAL DATA

4.4.1.3 STATIC IP MODE BY MANUAL SETTINGS

1. Select this option to manually enter the IP address.

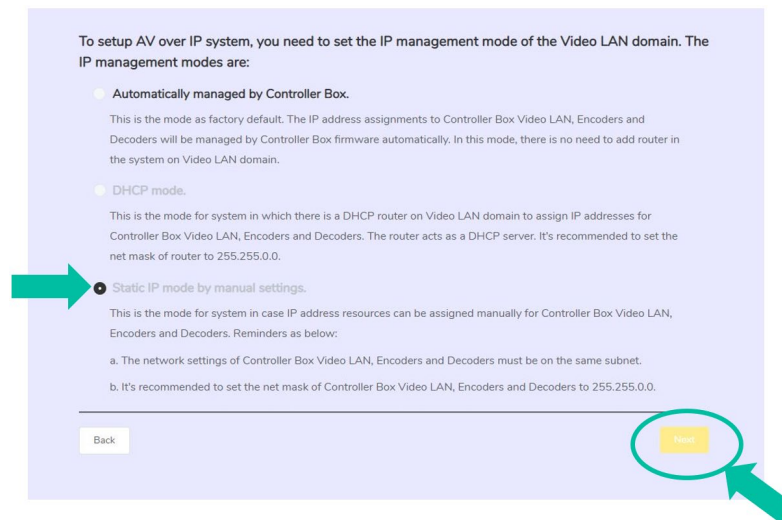

2. Press Next and then manually set the IP address, subnet mask and gateway of the Video LAN and then press Next.

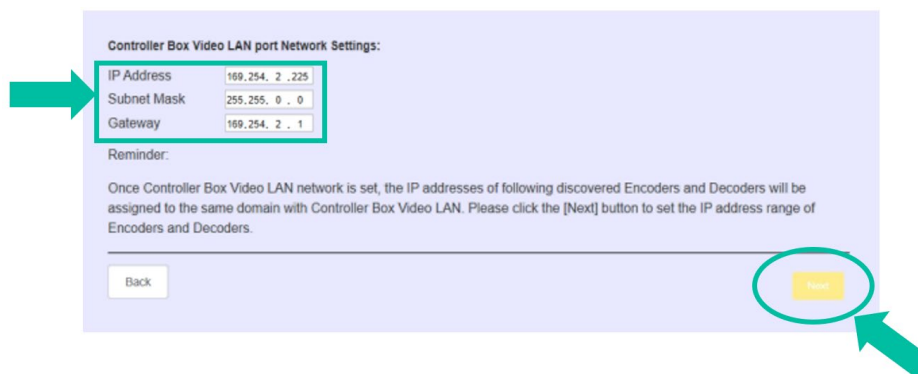

! It's strongly recommended to use different IP network domain from Control LAN port.

3. After the progress reaches 100%, enter the interface as shown in the figure below. On this interface, you can **set the IP address range of Transmitters and Receivers**. Once the setting is complete, **click the "Next" button** and the rest of the steps are the same as the first "Automatically Managed by Controller Box" mode.

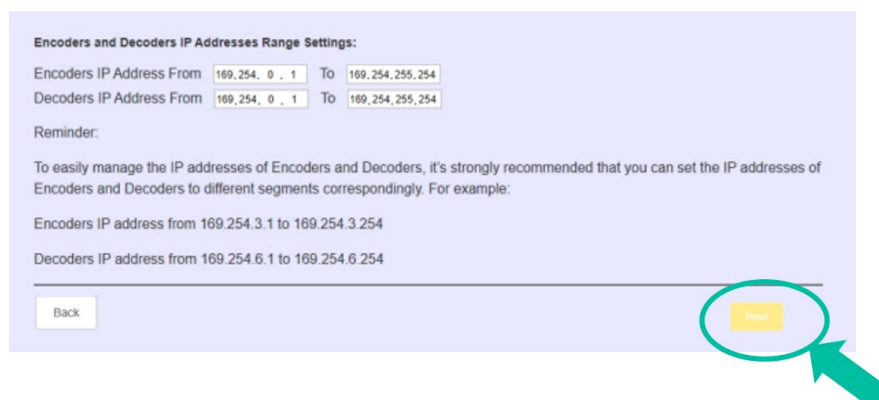

- PRECAUTIONS
- PACKAGE CONTENTS
- DESCRIPTION & FEATURES
- INSTALL & CONNECT
- START-UP & OPERATION
- PANEL FUNCTIONS
- TECHNICAL DATA

5. START-UP and OPERATION

5.1 WEB FUNCTIONS AND OPERATION

After setting up VEO-XCTRLG2 and assigning the VEO-XTI1CG2 and VEO-XRI1CG2 devices connected to the network to a given project, the **following menu of the web settings page will let the user manage and operate different aspects and functionalities concerning Transmitter and Receiver operation as explained in the next chapters.**

5.1.1 PREVIEW

On this page, the user can **select and preview the video content of a given Transmitter or Receiver placed in the system** by clicking the dropdown list on the right side and choosing which device to visualize.

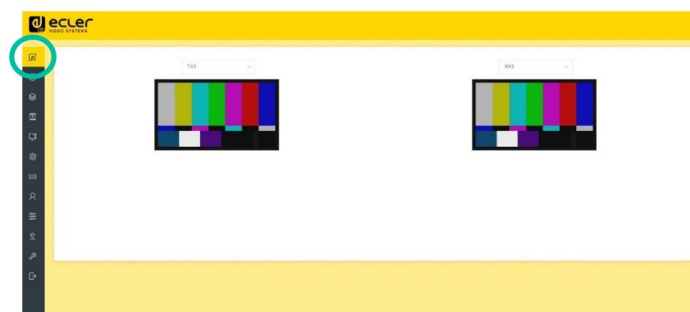

5.1.2 MATRIX CONTROL

- 1. Encoders: Display all the current Transmitters.** The text in the figure is the name of the device.
- 2. Decoders: Display all the current Receivers.** The text on the first line is the name of the Receiver, and the text on the second line refers to the Transmitter where the signal resource is from.

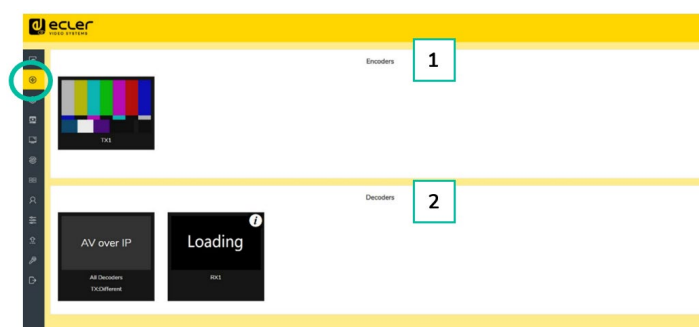

 If there is an image on a Transmitter, it means that the Encoder can be dragged. As shown in the figure above, if an Encoder is dragged to the place where the red arrow points to, all Receivers will share the same signal resource from this Transmitter; if a Transmitter is dragged to the place where the blue arrow points to, only the indicated Receiver can receive signals from this Transmitter.

 If a Transmitter shows “No Signal”, it means that it cannot be dragged.

| |
|------------------------|
| PRECAUTIONS |
| PACKAGE CONTENTS |
| DESCRIPTION & FEATURES |
| INSTALL & CONNECT |
| START-UP & OPERATION |
| PANEL FUNCTIONS |
| TECHNICAL DATA |

5.1.3 VIDEOWALL CONTROL

On this page, the user can **select different videowalls and configurations** that have been set up on the “Video Wall Management” page ([refer to chapter Videowall Management for further information](#)) by clicking the drop-down boxes labelled “Video Wall Selection” and “Configuration Selection”.

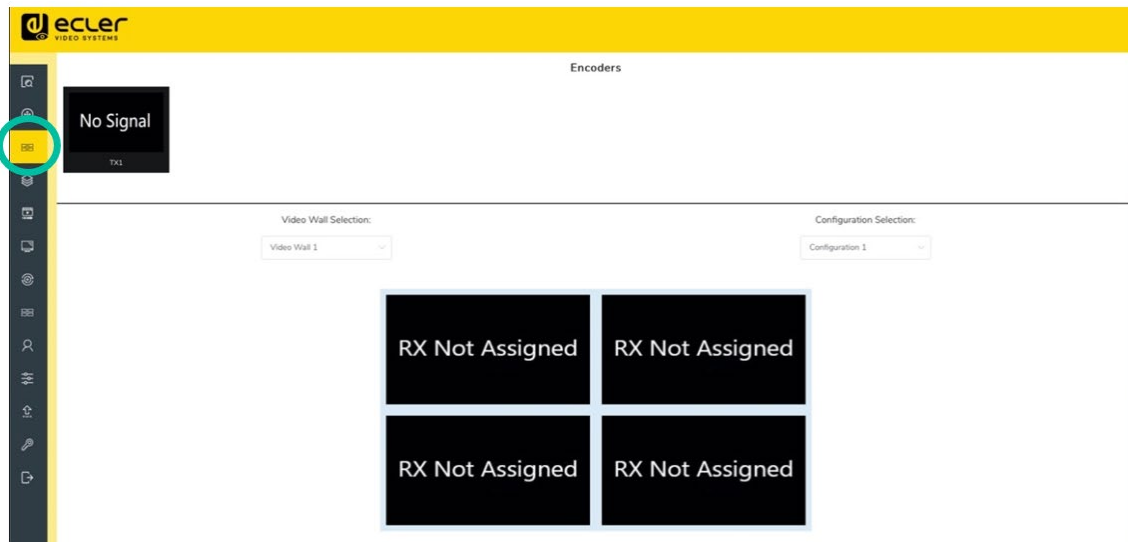

- **Encoders:** Display all the current Transmitters. The text in the figure is the name of the device.
- **Decoders:** Display all the current Receivers. The text on the first line is the name of the Decoder, and the text on the second line refers to the Transmitter where the signal resource is from.



Dragging Transmitters at the top of the page to the videowall will assign it to the chosen Receiver (and associated screen on the video wall composition).



PRECAUTIONS

PACKAGE CONTENTS

DESCRIPTION & FEATURES

INSTALL & CONNECT

START-UP & OPERATION

PANEL FUNCTIONS

TECHNICAL DATA

5.1.4 PROJECT

This section allows the user **to create a Project**.

- A. **Current Devices:** Devices that have been added to the current project.
- B. **Unassigned Devices:** Devices not added to the current project.

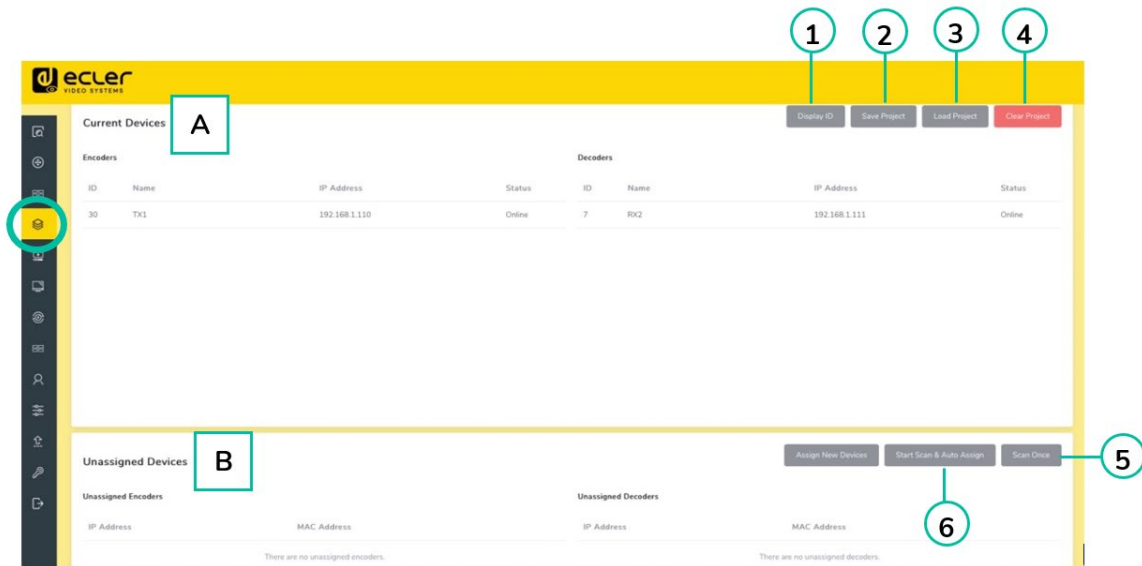

1. Click **“Display ID”** to display the ID or PATTERN of the Receivers.
2. Click **“Save Project”** to save the project file (`config_file.json`), so that you can use the saved project next time without scanning devices again.
3. Click **“Load Project”** to load the project file (`config_file.json`) to recover the saved project.
4. Click **“Clear Project”** to clear the current project, then you will need to setup devices again.
5. Click **“Scan Once”** to search devices that do not appear in the current project; Click **“Stop Scan”**, then it will stop searching.
6. Click **“Start Scan & Auto Assign”** to search new devices automatically and add to the current project.



PRECAUTIONS

PACKAGE CONTENTS

DESCRIPTION & FEATURES

INSTALL & CONNECT

START-UP & OPERATION

PANEL FUNCTIONS

TECHNICAL DATA

5.1.5 ENCODERS (TRANSMITTERS)

On this page, the user can **setup the current Transmitter** as required.

- A. **ID:** The ID of the current device. (Note: ID is never duplicated.)
- B. **Name:** The name of the current device. (Note: Name can't never be duplicated.)
- C. **MAC Address:** The MAC Address of the current device.
- D. **IP Address:** The IP Address of the current device.
- E. **Firmware:** The Firmware version No. of the current device.
- F. **Status:** The status (online or offline) of the current device.
- G. **EDID:** The EDID of the current device.
- H. **Audio Selection:** The Audio Selection of the current device (Analogue or HDMI).

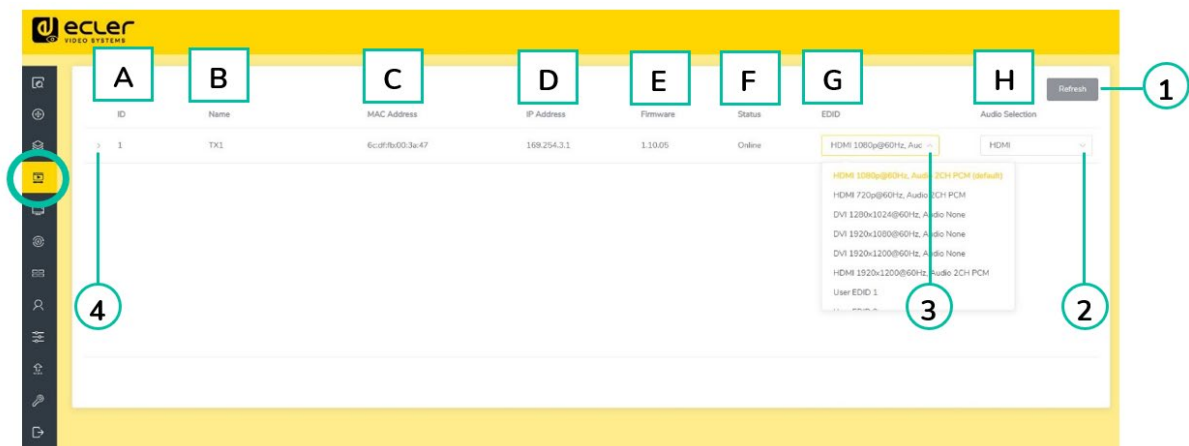

1. Click **“Refresh”** to refresh the data of the current Encoders.
2. Click the **drop-down list of “Audio Selection”** to set the current Transmitter’s audio output.
3. Click the **drop-down list of “EDID”** to set the current Transmitter’s EDID.
4. Click the **arrow icon placed left to “ID” column** to see the **expanded management menu** to check the detail information about the current Transmitter and tweak as needed, as shown in below.

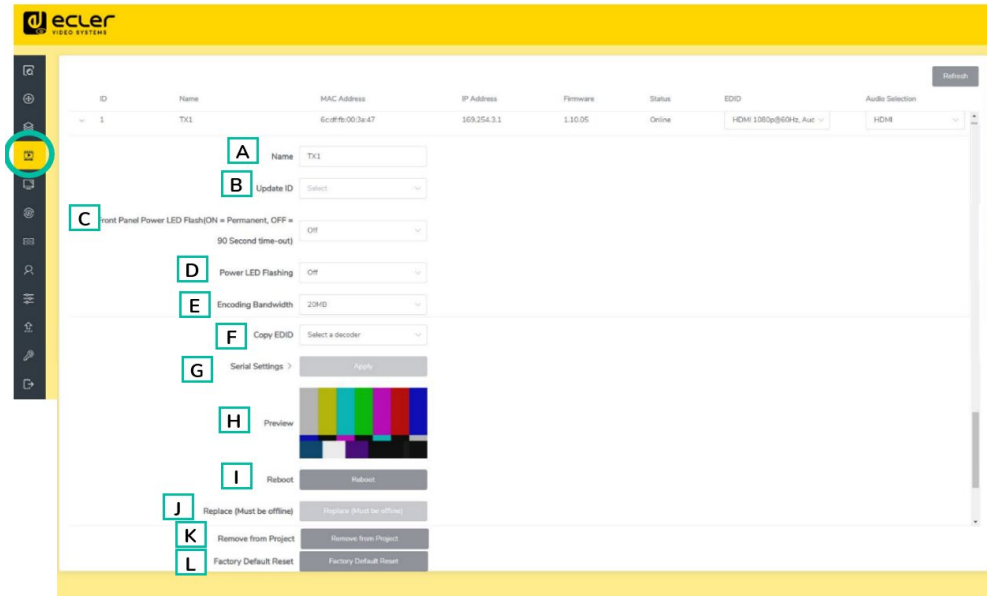

- A. **Name:** The name of the current device. (Note: Name can't never be duplicated).
- B. **Update ID:** The ID of the current device. (Note: ID is never duplicated.)
- C. **Front Panel Power LED Flash:** This parameter selects the status of the Front Panel Leds:
 - **ON:** The LEDs stay permanently ON.
 - **OFF:** The LEDs have a 90s timeout, and they turn off.
- D. **Power LED Flashing:**
 - **ON:** The Power LED stays permanently blinking.
 - **OFF:** The Power LED stays still without blinking.
 - **ON 90s:** The Power LED blinks for 90s and then stops.
- E. **Encoding Bandwidth:** this parameter adjusts the video quality choosing the maximum transmitted data for the main stream.
- F. **Copy EDID:** lets the user assign an external EDID,
- G. **Serial Settings:** This submenu lets the user to configure the settings for a serial communication. The user also will be able to turn "Serial Guest Mode" on or off. [Please refer to chapter RS-232 Routing](#) to learn the types of RS-232 command transmission in the system.
- H. **Preview:** This screen shows a preview visualization of the current video content of the selected Transmitter.
- I. **Reboot:** This parameter lets the user reboot the selected Transmitter.
- J. **Replace:** Lets the user to replace an Offline device for another one that has been factory defaulted.
- K. **Remove From Project:** This option will let the user to unassign the selected Transmitter from the current project.
- L. **Factory Default Reset:** This parameter lets the user get the selected Transmitter back to default settings.

| |
|------------------------|
| PRECAUTIONS |
| PACKAGE CONTENTS |
| DESCRIPTION & FEATURES |
| INSTALL & CONNECT |
| START-UP & OPERATION |
| PANEL FUNCTIONS |
| TECHNICAL DATA |

5.1.6 DECODERS (RECEIVERS)

On this page, the user can **setup the current Receiver** as required.

- A. **ID:** The ID of the current device. (Note: ID is not duplicated.).
- B. **Name:** The name of the current device. (Note: Name is not duplicated.).
- C. **MAC Address:** The MAC Address of the current device.
- D. **IP Address:** The IP Address of the current device.
- E. **Firmware:** The Firmware version of the current device.
- F. **Status:** The status (online or offline) of the current device.
- G. **Source:** The signal source (Transmitter) of the current device.
- H. **Scaler Resolution:** The resolution of the current device.
- I. **Function:** The mode of the current device (Matrix or Videowall).

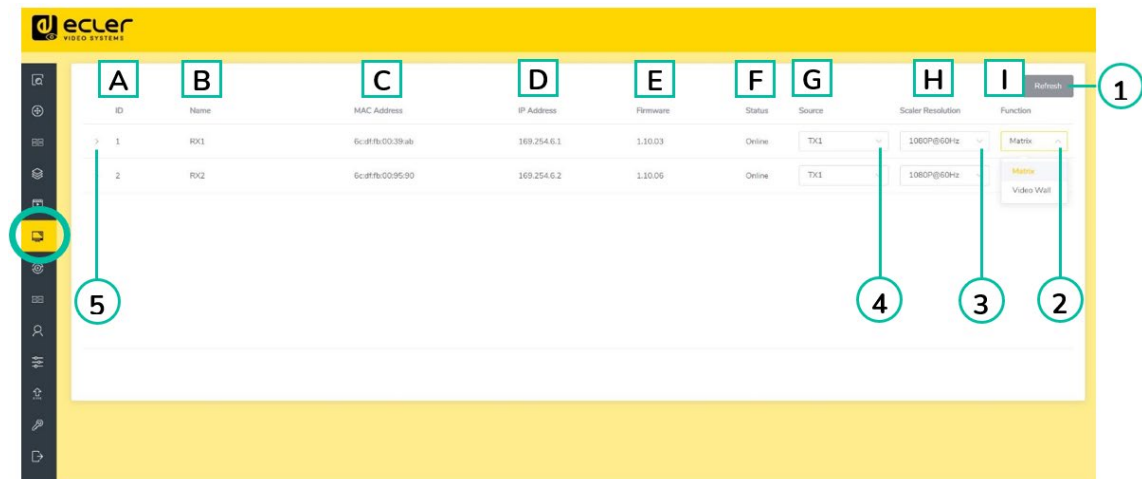

1. Click **“Refresh”** to refresh the data of the current Receivers.
2. Click the **drop-down list of “Function”** to select the **current Receiver mode**.
3. Click the **drop-down list of “Scaler Resolution”** to select the current Receiver’s resolution.
4. Click the **drop-down list of “Source”** to select the current Receiver’s signal source.
5. Click the **arrow icon placed left to “ID” column** to see the **expanded management menu** to check the detail information about the current Receiver and tweak as needed, as shown in below.

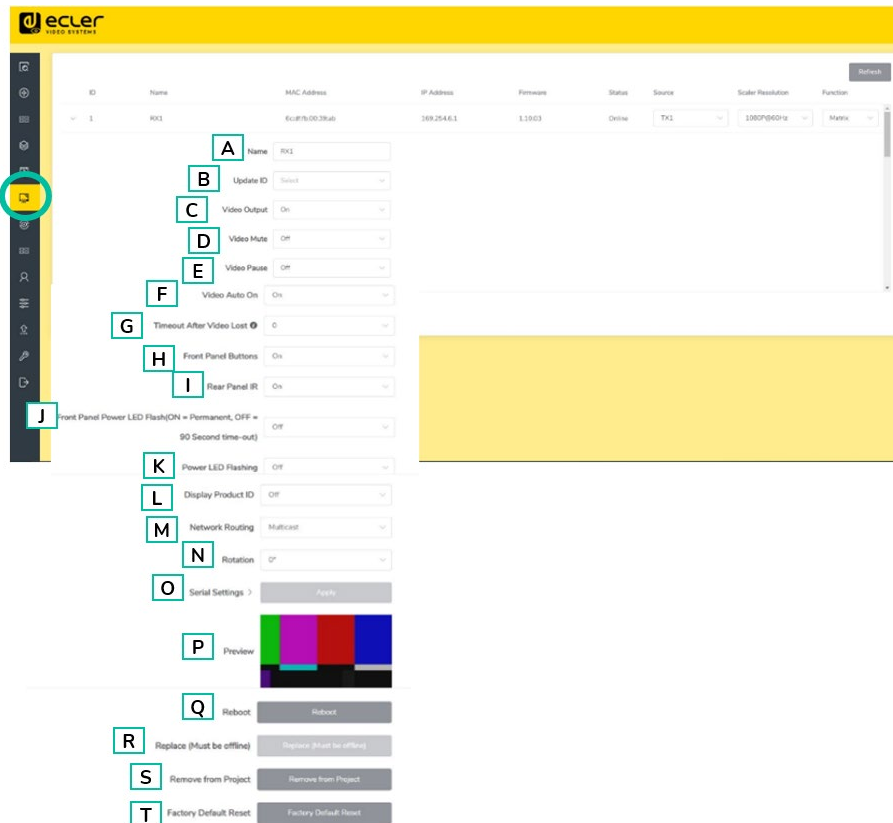

- A. **Name:** The name of the current device. (Note: Name can't never be duplicated.).
- B. **Update ID:** The ID of the current device. (Note: ID is never duplicated.)
- C. **Video Output:** This parameter turns off the HDMI output.
- D. **Video Mute:** This parameter shows a black screen instead of the actual content.
- E. **Video Pause:** This parameter freezes the last frame shown.
- F. **Video Auto On:** This parameter allows to turn video signal on when a new RX is connected.
- G. **Timeout After Video Lost:** This parameter will turn off HDMI output when there's no video signal detected after the chosen time period (minutes).
- H. **Front Panel Buttons:** This parameter lets the user enable and disable the front panel buttons.
- I. **Rear Panel IR:** This parameter lets the user enable or disable the rear IR panel (reserved for future upgrades).
- J. **Front Panel Power LED Flash:** This parameter selects the status of the Front Panel Leds:
 - **ON:** The LEDs stay permanently ON.
 - **OFF:** The LEDs have a 90s timeout, and they turn off.
- K. **Power LED Flashing:**
 - **ON:** The Power LED stays permanently blinking.
 - **OFF:** The Power LED stays still without blinking.
 - **ON 90s:** The Power LED blinks for 90s and then stops.

- L. **Display Product ID:** this parameter shows the current Product ID on the screen.
- M. **Network Routing:** lets the user assign between Unicast and Multicast network topology.
- N. **Rotation:** This parameter will rotate the output image from 0° to 270°.
- O. **Serial Settings:** This submenu lets the user configure the settings for a serial communication. The user also will be able to turn “Serial Guest Mode” on or off. Please [Please refer to chapter RS-232 Routing](#) to learn the types of RS-232 command transmission in the system.
- P. **Preview:** This screen shows a preview visualization of the current video content of the selected Transmitter.
- Q. **Reboot:** This parameter lets the user reboot the selected Receiver.
- R. **Replace:** Lets the user replace an Offline device for another one that’s been factory defaulted
- S. **Remove From Project:** This option will let the user to unassign the selected Receiver from the current project.
- T. **Factory Default Reset:** This parameter lets the user get the selected Receiver back to default settings.

5.1.7 LINKED SIGNAL ROUTING

On this page, the user **can independently route the different types of signals between Transmitter & Receiver devices (Video/Audio, Serial)**. This allows to establish a permanent connection that can be used for a locked routing for some certain source devices or an extending control for a third-party control system.

When the drop-down box shows “**FOLLOW**”, the corresponding signal will come from current Transmitter device.

 For **example**, click the drop-down box of Video to select a new source “Encoder 003” for Receiver 1, as shown in the figure below.

Please click “Locked Routing Help” for details.

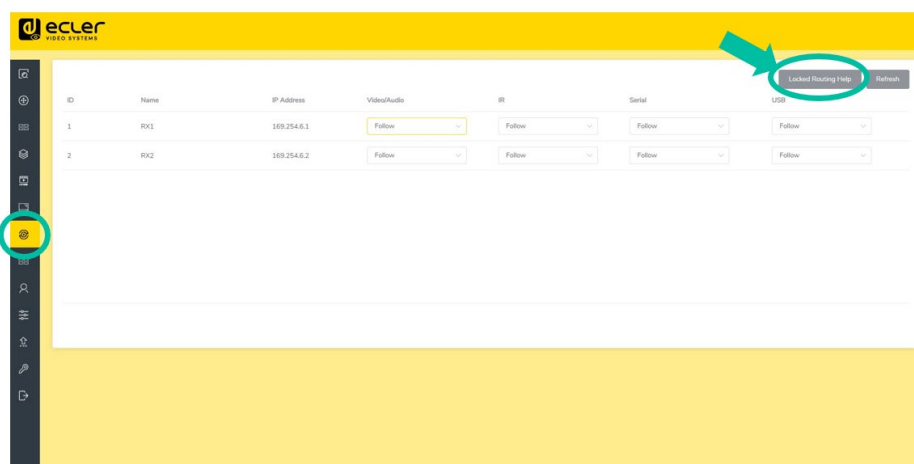

5.1.7.1 RS-232 ROUTING

“Serial Guest Mode” can be enabled/disabled on the Transmitter / Receiver web setting page. [See chapter Encoders \(Transmitters\)](#) or [chapter Decoder \(Receivers\)](#) to assign the RS-232 type of routing:

- **ON:** allows the RS-232 connection of a device to be sent over the IP network (IP / RS-232 command in, to RS-232 out). This will allow third party control systems the ability to send an RS-232 or IP command to the VEO-XCTRLG2 and a RS-232 command to be sent out of a Receiver or Transmitter as a result.

 It is recommended turning “Serial Guest Mode” on and off when required as serial commands being sent into the VEO-XCTRLG2 will be forwarded to every device that has it enabled. **When Serial Guest Mode is enabled, Locked Signal Routing is disabled.**

- **OFF:** a static fixed routing for distributing two-way RS-232 commands between a set of Transmitters and all the associated Receivers that have Fixed Routing configured. So, this serial connection allows point to point, point to multipoint and multipoint to multipoint serial bidirectional transmitting scenarios.

 **When Serial Guest Mode is disabled, Locked Signal Routing is enabled.**

| |
|---|
|  |
| PRECAUTIONS |
| PACKAGE CONTENTS |
| DESCRIPTION & FEATURES |
| INSTALL & CONNECT |
| START-UP & OPERATION |
| PANEL FUNCTIONS |
| TECHNICAL DATA |

5.1.8 VIDEOWALL MANAGEMENT

On this page, the user can **create and configure videowall** as required.



- Each Receiver can be set into a part of a videowall layout.
- Each system can contain multiple video walls with different sizes.
- Each video wall can be assigned to different screens and different layouts that range from 1x2 up to 9x9.

The controller creates and manages the videowall configurations and provides a **simplified control interface and API commands** to third party control system.

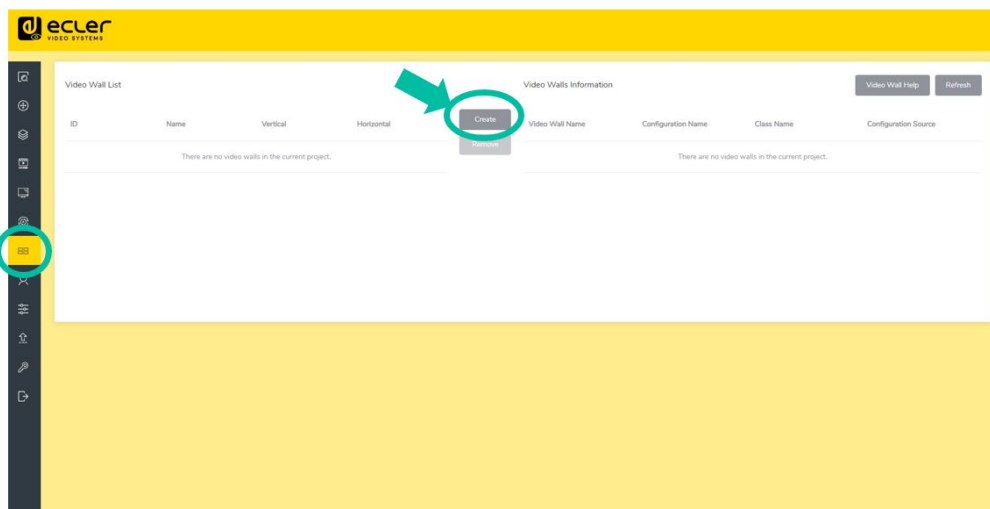

1. Click “Create”, then a pop-up window will be shown as below.

The user can set the VideoWall ID, Name, Horizontal and Vertical panel numbers.

Then click “Create” to create the Video Wall.

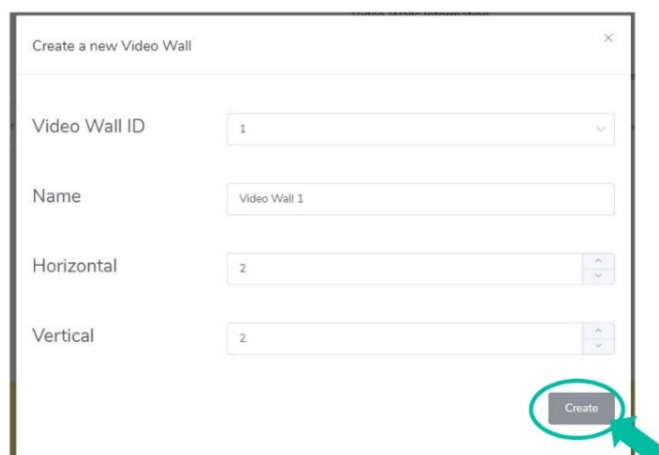

Up to 9 videowalls can be created.



PRECAUTIONS

PACKAGE CONTENTS

DESCRIPTION & FEATURES

INSTALL & CONNECT

START-UP & OPERATION

PANEL FUNCTIONS

TECHNICAL DATA

2. Select the video wall that you want to configure on the “Video Wall List”, then click “Assign Decoder” to enter the Receiver assignment page.

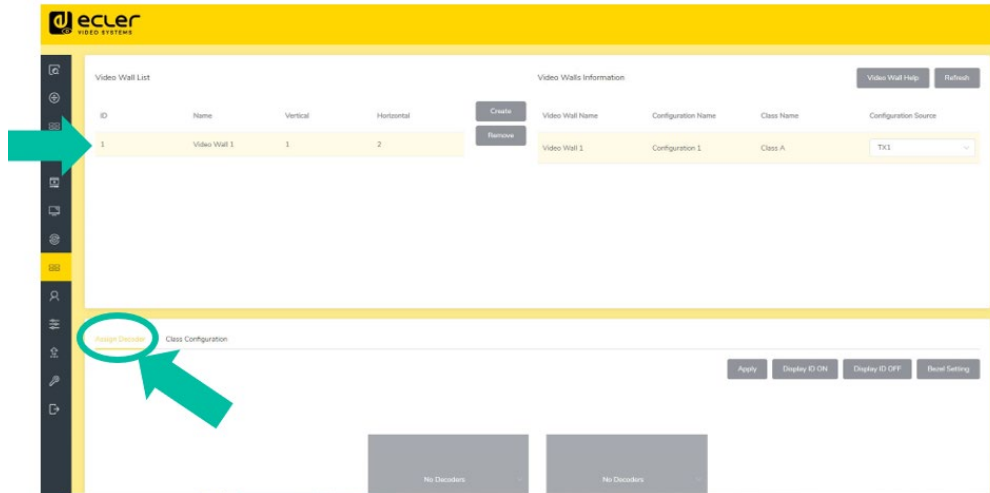

3. Click each screen to select the corresponding Receiver device, then click “Apply”.

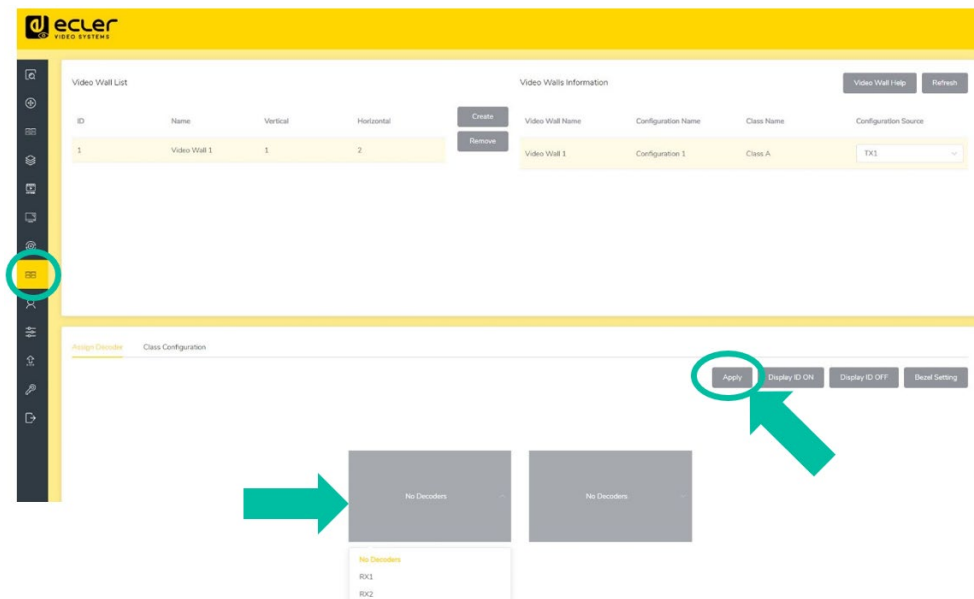

A Receiver can only be assigned to one videowall.

4. Click “Class Configuration” to enter the class configuration page, then click each screen to select the corresponding Class as required (the same class name will form a video wall, you can create a regular or irregular video wall by Class Configuration). Then click “Apply”.

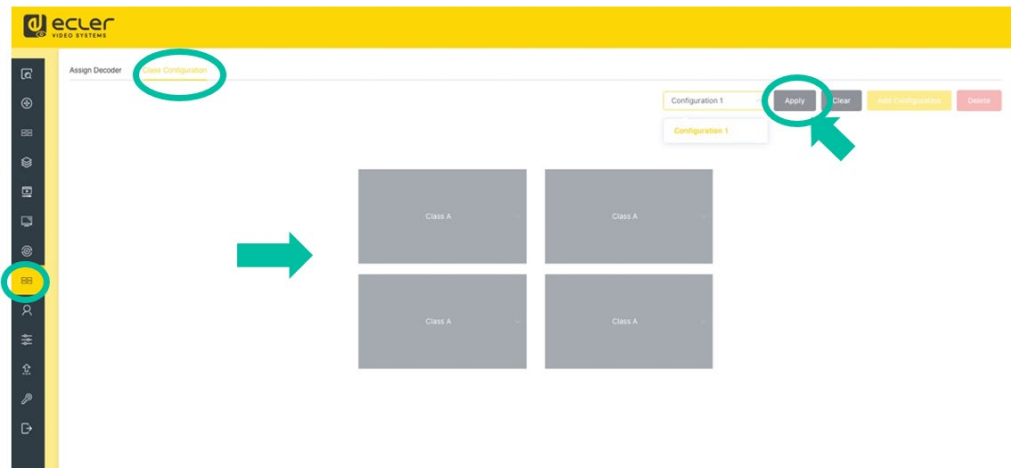

Up to 7 configurations can be set up for different application scenarios.



PRECAUTIONS

PACKAGE CONTENTS

DESCRIPTION & FEATURES

INSTALL & CONNECT

START-UP & OPERATION

PANEL FUNCTIONS

TECHNICAL DATA

5.1.9 USERS

On this page, **new user accounts can be added**. The controller web GUI can be setup with different users each with their own control privileges. This will allow the user to create a unique login and feature settings such as inputs and outputs that each person has access to.

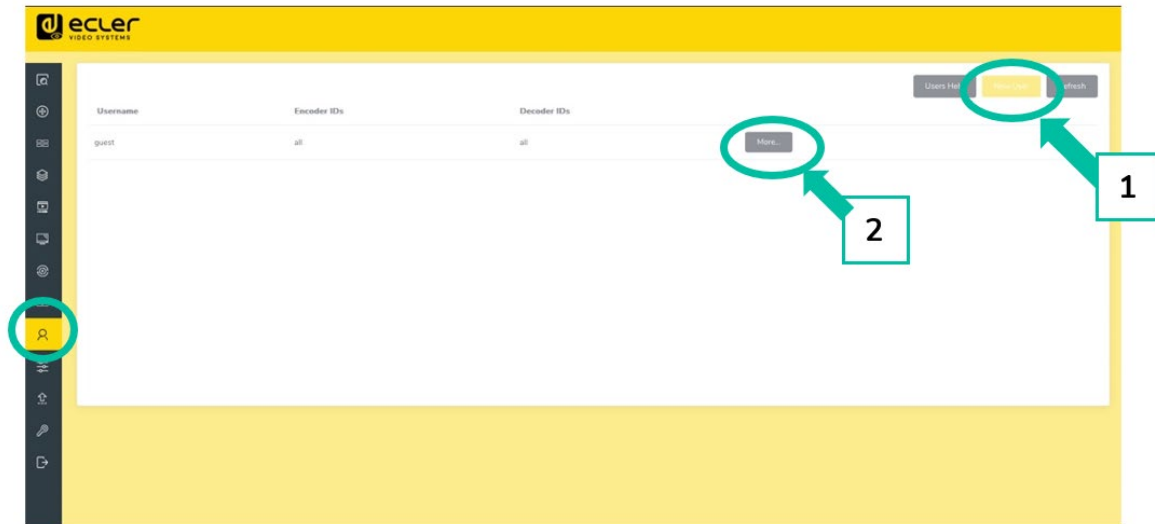

1. Click “New User” to create a new user.

Create User
×

Username

Password

Confirm Password

2. Click “More” to manage user access privileges.

Update guest
×

Update Permissions

Delete

- 🏠
- PRECAUTIONS
- PACKAGE CONTENTS
- DESCRIPTION & FEATURES
- INSTALL & CONNECT
- START-UP & OPERATION
- PANEL FUNCTIONS
- TECHNICAL DATA

5.1.10 CONTROLLER SETTINGS

On this page, the user can configure communication and network settings for the control and video LAN networks as required.

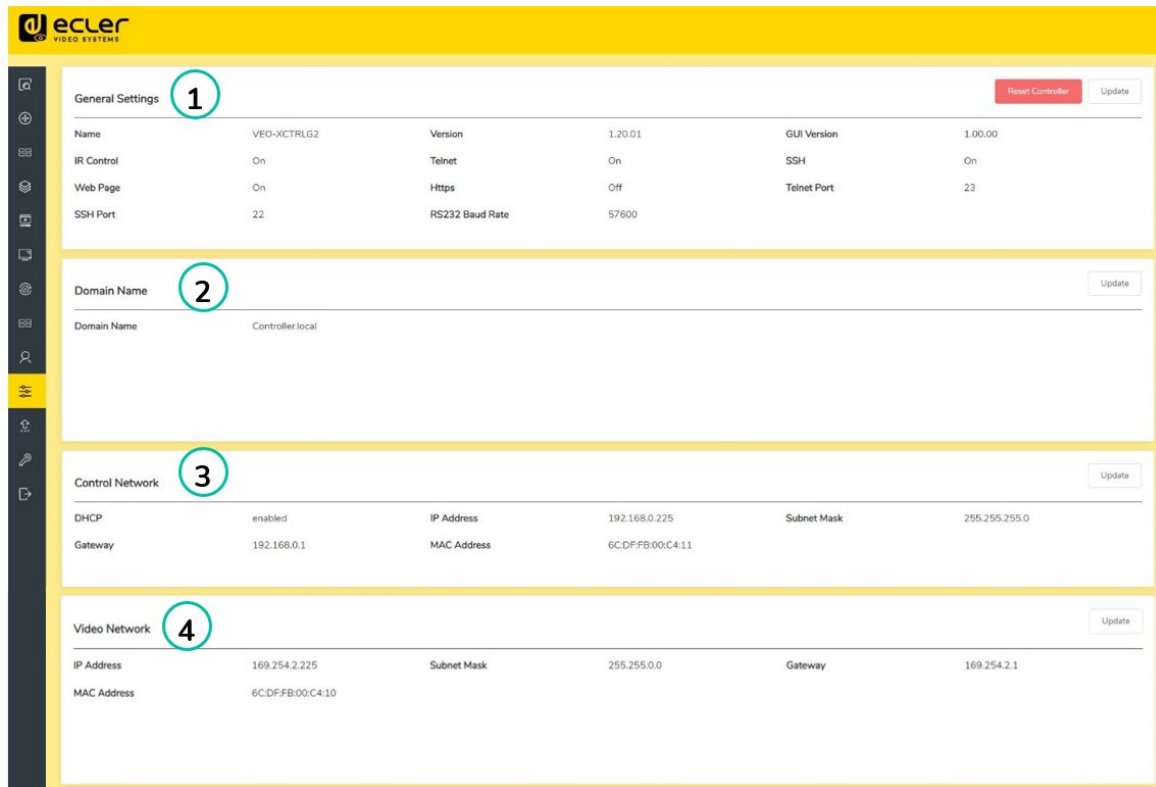

- 1. General Settings:** The section shows a summary of the basic VEO-XCTRLG2 settings. Communication parameters such as IR Control, Telnet, Telnet Port, SSH, SSH Port, Web Page Access, HTTPS or RS-232 baudrate can be configured clicking on “Update” button.

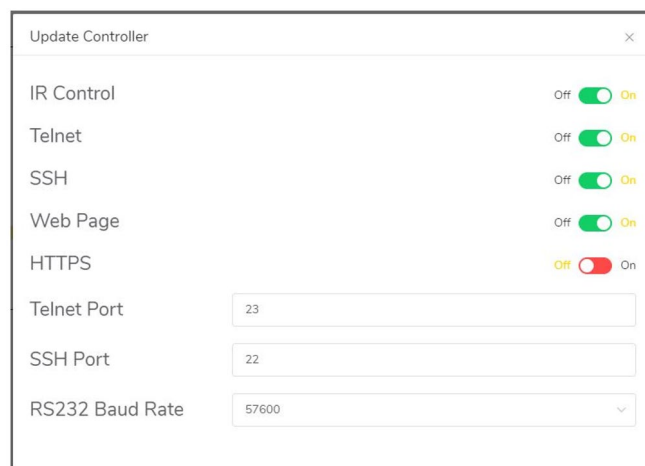

2. **Domain Name:** allows the user to change the domain tag that can be used instead of the actual IP address to enter the Web GUI just clicking "Update" button and entering the new name.

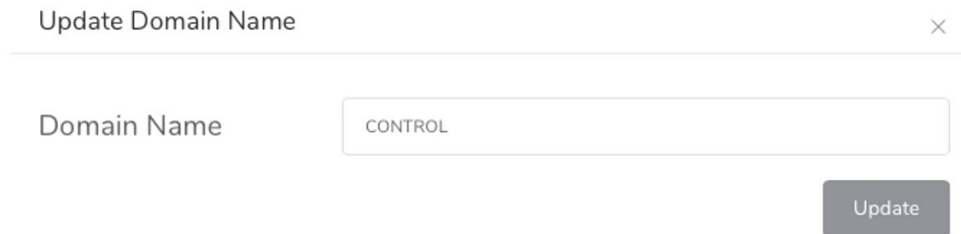

Update Domain Name [X]

Domain Name:

[Update]

3. **Control Network:** This section allows the user to set the network configuration and DHCP parameters for the VEO-XCTRLG2 "Control LAN" port.

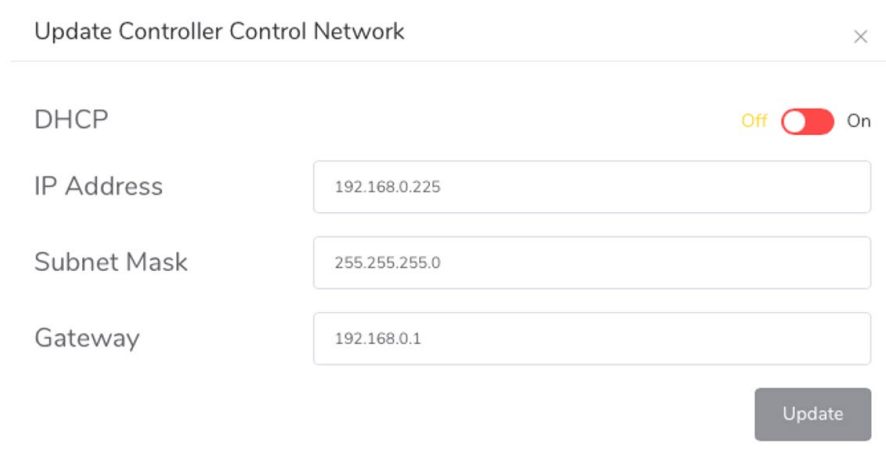

Update Controller Control Network [X]

DHCP: Off On

IP Address:

Subnet Mask:

Gateway:

[Update]

4. **Video Network:** This section allows the user to set the network configuration for the VEO-XCTRLG2 "Video LAN" port.

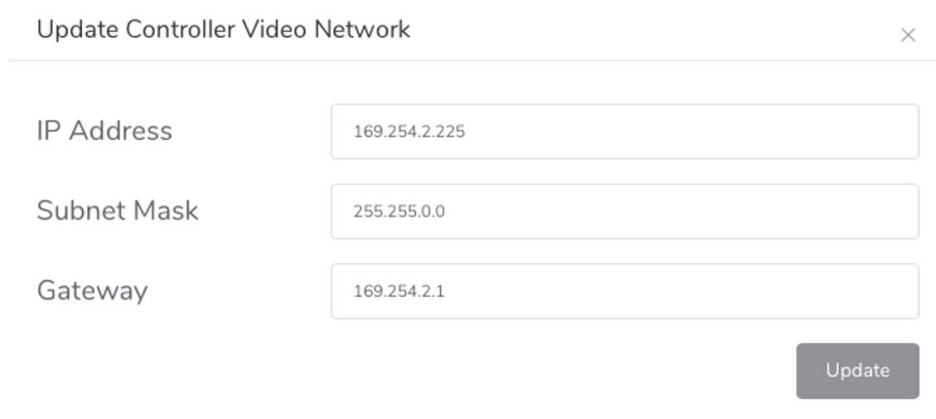





Update Controller Video Network [X]

IP Address:

Subnet Mask:

Gateway:

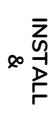
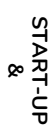
[Update]

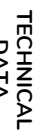
-  PRECAUTIONS
-  PACKAGE CONTENTS
-  DESCRIPTION & FEATURES
-  INSTALL & CONNECT
-  START-UP & OPERATION
-  PANEL FUNCTIONS
-  TECHNICAL DATA

5.1.10.1 TCP COMMAND LIST

To make use of TCP 3rd party remote control, it is necessary to enter current IP address of VEO-XCTRLG2 and TELNET port configured to access the device.

It is important to add carriage return (<CR>,\r,0x0D) and line feed (<LF>,\n,0x0A) characters at the end of each command:

| Command Code | Description | Command Return |
|----------------|--|----------------------------------|
| OUT xxx FR yyy | <p>RESPONSE Set RX ID xxx connect to TX ID yyy</p> <p>PARAMETERS DESCRIPTION</p> <ul style="list-style-type: none"> • xxx: RX ID number, ranging from 1 to 762 • yyy: TX ID number, ranging from 1 to 762 | Set OUTPUT xxx From INPUT:yyy |
| OUT xxx ID yyy | <p>RESPONSE Set RX ID xxx to ID yyy</p> <p>PARAMETERS DESCRIPTION</p> <ul style="list-style-type: none"> • xxx: RX ID number before change, ranging from 1 to 762 • yyy: RX ID number after change, ranging from 1 to 762. • Note: Only change the RX ID number, not change IP address. | Set OUTPUT xxx ID to yyy |
| OUT xxx SL yyy | <p>RESPONSE Set RX ID xxx to SCALE yyy</p> <p>PARAMETERS DESCRIPTION</p> <ul style="list-style-type: none"> • xxx: RX ID number to be set, ranging from 1 to 762 • yyy: SCALE mode number, range • 0~19,0:Pass Through (default); 1: HDMI 1080p@60Hz; 2: HDMI 1080p@50Hz; 3: HDMI 1080p@30Hz; 4: HDMI 1080p@25Hz; 5: HDMI 1080p@24Hz; 6: HDMI 720p@60Hz; 7 : HDMI 720p@50Hz; 8: HDMI 576p@50Hz; 9: HDMI 480p@60Hz; 10: HDMI 640x480@60Hz; 11: HDMI 800x600@60Hz; 12: HDMI 1024x768@60Hz; 13: HDMI 1280x800@60Hz; 14: HDMI 1280x1024@60Hz; 15: HDMI 1366x768@60Hz; 16: HDMI 1440x900@60Hz; 17: HDMI 1600x1200@60Hz; 18: HDMI 1680x1050@60Hz; 19: HDMI 1920x1200@60Hz. | Set OUTPUT xxx SCALE to yyy |

- PRECAUTIONS
- PACKAGE CONTENTS
- DESCRIPTION & FEATURES
- INSTALL & CONNECT
- START-UP & OPERATION
- PANEL FUNCTIONS
- TECHNICAL DATA

| | | |
|-------------------------------|--|---|
| <p>OUT xxx PM yyy</p> | <p>RESPONSE Set RX ID xxx to max TX ID number allows to connect</p> <p>PARAMETERS DESCRIPTION</p> <ul style="list-style-type: none"> • xxx: RX ID number to be set • yyy: Set the maximum ID number that RX can connect to TX, ranging from 0 to 762. When yyy is 0, it means that TX with ID 1~762 can be connected; When yyy is 1~762, it means that TX with ID 1~yyy can be connected. | <p>Set OUTPUT xxx PERMISSION to yyy</p> |
| <p>IN xxx ID yyy</p> | <p>RESPONSE Set TX ID xxx to ID yyy</p> <p>PARAMETERS DESCRIPTION</p> <ul style="list-style-type: none"> • xxx: TX ID number before change, ranging from 1 to 762; • yyy: TX ID number after change, ranging from 1 to 762. • Note: Only change the TX ID number, not change the IP address. | <p>Set INPUT xxx ID to yyy</p> |
| <p>IN xxx EDID yyy</p> | <p>RESPONSE Set TX ID xxx EDID to yyy</p> <p>PARAMETERS DESCRIPTION</p> <ul style="list-style-type: none"> • xxx: TX ID number to be set, range 1~762 • yyy: EDID serial number, range 0~7, • 0: HDMI 1080p@60Hz , Audio 2CH PCM (default) ; • 1: HDMI 720p@60Hz , Audio 2CH PCM ; • 2: DVI 1280x1024@60Hz , Audio None ; • 3: DVI 1920x1080@60Hz , Audio None ; • 4: DVI 1920x1200@60Hz , Audio None ; • 5: HDMI 1920x1200@60Hz , Audio 2CH PCM ; • 6: User EDID 1 ; • 7: User EDID 2 | <p>Set INPUT xxx EDID to yyy</p> |
| <p>MAC GET</p> | <p>RESPONSE Get MAC address</p> <p>PARAMETERS DESCRIPTION</p> <ul style="list-style-type: none"> • Get the MAC address of current device | <p>Get MAC xx:xx:xx:xx:xx:xx</p> |

| |
|---|
|  |
| PRECAUTIONS |
| PACKAGE CONTENTS |
| DESCRIPTION & FEATURES |
| INSTALL & CONNECT |
| START-UP & OPERATION |
| PANEL FUNCTIONS |
| TECHNICAL DATA |

5.1.11 FIRMWARE UPDATE

On this page, the user **can separately update the firmware of any Transmitter/Receiver** by clicking the corresponding “Update” button on the right or update all the firmware of Transmitter/Receiver simultaneously by clicking the corresponding “Update All” button.

There is also the **possibility to update the Second Stream chip firmware** by clicking the “Update SS Firmware” button.

To **separately update the firmware** of any Transmitter/Receiver:

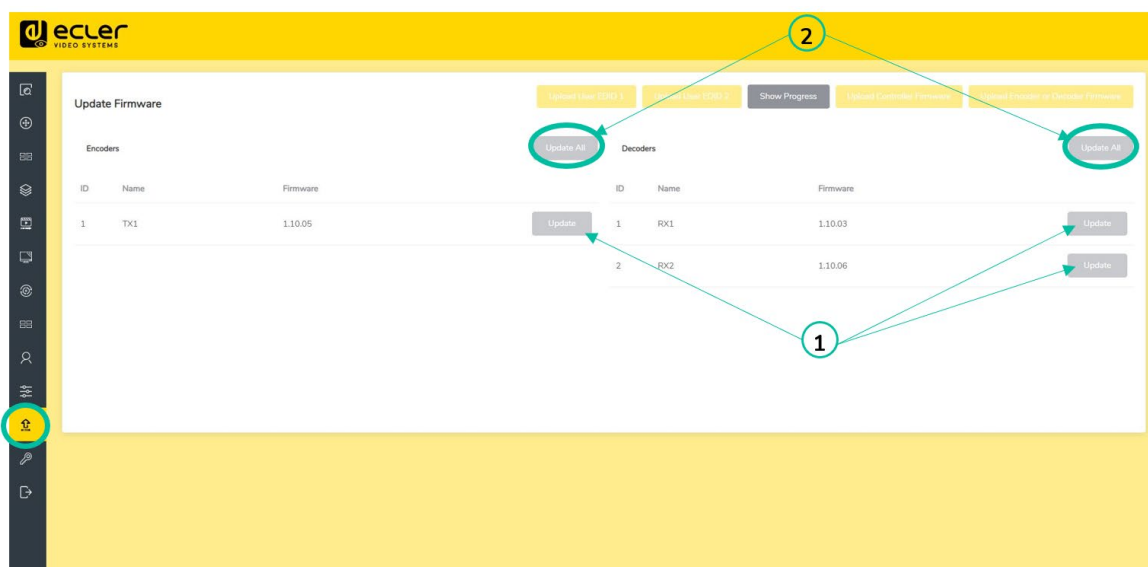

1. Transmitter / Receiver **firmware can be updated one by one** by clicking the “**Update**” button on the right of each Transmitter / Receiver.
2. **Firmware of all Transmitters / Receivers can be updated simultaneously** by clicking the “**Update All**” button of Transmitter / Receiver.

5.1.12 PASSWORD UPDATE

On this page, you can **change the password**.

 Please note that **after changing**, it will skip to the Web browser home page or the Web GUI login interface automatically. **You need to log in the Web GUI again with the new password.**



The screenshot shows a web form titled "Update Password" with a close button (X) in the top right corner. The form contains two input fields: "Password" and "Confirm Password". Below the input fields is a button labeled "Update Password".

5.1.13 LOG OUT

This parameter  will allow the user to sign out of the Web Gui interface.

| |
|---|
|  |
| PRECAUTIONS |
| PACKAGE CONTENTS |
| DESCRIPTION & FEATURES |
| INSTALL & CONNECT |
| START-UP & OPERATION |
| PANEL FUNCTIONS |
| TECHNICAL DATA |

6. PANEL FUNCTIONS

6.1 FRONT PANEL



1. **RESET Button:** Press and hold this button (about 10 seconds) until Status LED starts flashing: the controller will be reset automatically.
2. **POWER LED:** The red LED will light on when the controller is powered on.
3. **STATUS LED:** The status LED will flash in yellow-green every 1 second until the controller boots up is complete and Control LAN is ready, then it becomes solid green.

6.2 REAR PANEL

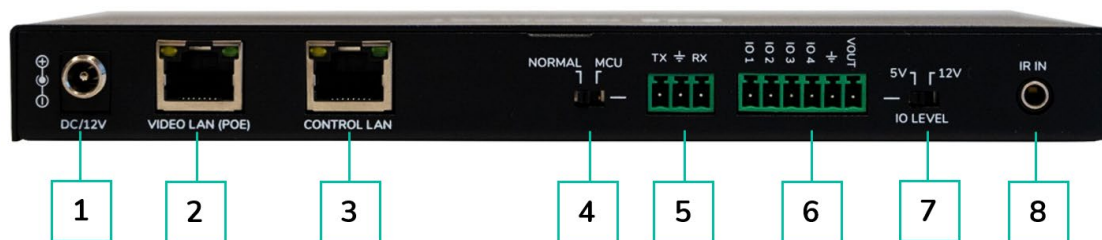

1. **DC 12V:** DC 12V/1A power input port.
2. **VIDEO LAN (POE):** 100Mbps Video LAN port, supporting POE function.

 When POE is enabled, DC 12V/1A power supply is not required.
3. **CONTROL LAN:** 100Mbps LAN control port.
4. **MCU/NORMAL DIP Switch:**
 - Normal mode (Default): The RS-232 port is used for serial port commands control.
 - MCU mode: The RS-232 port is used for MCU software upgrade.
5. **RS-232 Port:** Serial Communication Port
6. **GPIO Port:** 4 channel I/O level outputs, 1 channel grounding, 1 channel power supply to the outside (reserved for future upgrades).
7. **I/O LEVEL Switch:** Used to control I/O level output and VOUT voltage (reserved for future upgrades).
 - Switch to left: 5V I/O level output, VOUT is 5V
 - Switch to right: 12V I/O level output, VOUT is 12V.
8. **IR Input:** 12V IR Input port (reserved for future upgrades).

| |
|------------------------|
| PRECAUTIONS |
| PACKAGE CONTENTS |
| DESCRIPTION & FEATURES |
| INSTALL & CONNECT |
| START-UP & OPERATION |
| PANEL FUNCTIONS |
| TECHNICAL DATA |

7. TECHNICAL DATA

7.1 TECHNICAL SPECIFICATIONS

VEO-XCTRLG2

| DEVICE CONTROL | |
|---------------------------------|--|
| Control Connectors | RJ-45, Euroblock, Jack 3.5mm |
| Control Protocols | Web, TCP, RS-232 |
| Status Indicators | Power LED (Red), Status LED (Green) |
| PASS-THROUGH CONTROL | |
| Pass-through Connectors | Euroblock, Jack 3.5mm |
| Pass-through Protocols | RS-232 |
| NETWORK | |
| Network Connectors | 2 x RJ-45 |
| Network Requirements | IGMP Snooping |
| Average Streaming Bitrate | Configurable via software 1-20 Mbps |
| Transmission Distance | 100m via Ethernet |
| ELECTRICAL | |
| Power Supply | PoE (802.3af Class 3) or External Power supply |
| AC Mains Connector | 100-240VAC 50-60Hz with EU, UK, US, AU blades |
| DC Mains Connector | 12VDC-1A with coaxial DC connector |
| Power Consumption | 4.5 W |
| PHYSICAL | |
| Operating Temperature | Min: 0°C; 32°F Max: 40°C; 104°F |
| Operating Humidity | <90% HR |
| Installation Options | Desktop, 19" racks (1/2RU), VEO-RACK19 |
| Included Accessories | <ul style="list-style-type: none"> ▪ 2x 3pins Euroblock connector ▪ 4x M3 screws 4mm ▪ 2x Mounting Ears ▪ 1x 12V PSU |
| Optional Accessories | VEO-RACK19 |
| Dimensions (W x H x D) | 204 x 21.5 x 98,5 mm (8.03 x 0.85 x 3.88 in. |
| Shipping Dimensions (W x H x D) | 257 x 78 x 159 mm / 10.12 x 30.07 x 6.26 in. |
| Weight | 0.540 Kg. / 1.19 lb |
| Shipping Weight | 0.95 Kg / 0.21 lb |
| Chassis Material | Metal |
| Finished Colour | Black |



PRECAUTIONS

PACKAGE CONTENTS

DESCRIPTION & FEATURES

INSTALL & CONNECT

START-UP & OPERATION

PANEL FUNCTIONS

TECHNICAL DATA



PRECAUTIONS

PACKAGE CONTENTS

DESCRIPTION & FEATURES

INSTALL & CONNECT

START-UP & OPERATION

PANEL FUNCTIONS

TECHNICAL DATA



All product characteristics are subject to variation due to production tolerances. **NEEC AUDIO BARCELONA S.L.** reserves the right to make changes or improvements in the design or manufacturing that may affect these product specifications.

For technical queries contact your supplier, distributor or complete the contact form on our website, in [Support / Technical requests](#).

Motors, 166-168 -08038 Barcelona - Spain-(+34) 932238403 | information@ecler.com | www.ecler.com