

# Panasonic®

## Operating Instructions

---

4K Integrated Camera

Model No. **AW-UE160WP**  
Model No. **AW-UE160KP**  
Model No. **AW-UE160WPC**  
Model No. **AW-UE160KPC**  
Model No. **AW-UE160WE**  
Model No. **AW-UE160KE**  
Model No. **AW-UE160WED**  
Model No. **AW-UE160KED**

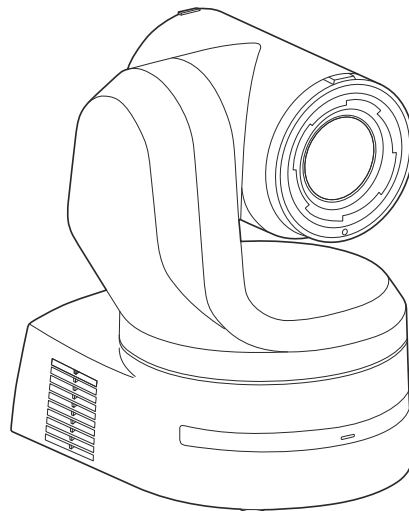

**HEVC** Advance™  
Covered by patents at [patentlist.accessadvance.com](http://patentlist.accessadvance.com)

**HDMI**™

Before operating this product, please read the instructions carefully and save this manual for future use. Please carefully read the "Read this first!" (pages 2 to 8) of this Manual before use.

# Read this first! (For AW-UE160WP, AW-UE160KP)

## WARNING:

- To reduce the risk of fire or electric shock, do not expose this equipment to rain or moisture.
- To reduce the risk of fire or electric shock, keep this equipment away from all liquids. Use and store only in locations which are not exposed to the risk of dripping or splashing liquids, and do not place any liquid containers on top of the equipment.

## WARNING:

Always keep the main unit mounting screw, bracket mounting screws and drop-prevention wire mounting screw out of the reach of infants and small children.

## WARNING:

Installation should only be performed by qualified installation personnel.  
Improper installation may result in the entire apparatus falling down and causing injury.

## CAUTION:

Do not remove panel covers by unscrewing.  
To reduce the risk of electric shock, do not remove the covers.  
No user serviceable parts inside.  
Refer servicing to qualified service personnel.

## CAUTION:

In order to maintain adequate ventilation, do not install or place this unit in a bookcase, built-in cabinet or any other confined space. To prevent risk of electric shock or fire hazard due to overheating, ensure that curtains and any other materials do not obstruct the ventilation.

## CAUTION:

To reduce the risk of fire or electric shock and annoying interference, use the recommended accessories only.

## CAUTION:

Check the installation at least once a year.  
An improper installation could cause the unit to fall off resulting in personal injury.

## CAUTION:

A coin type battery is installed inside of the unit.  
Do not expose the unit to excessive heat such as sunshine, fire or the like.

 indicates safety information.

## FCC NOTICE (USA)

### Supplier's Declaration of Conformity

Model Number: AW-UE160WP/AW-UE160KP  
Trade Name: Panasonic  
Responsible Party: Panasonic Corporation of North America  
Two Riverfront Plaza, Newark, NJ 07102  
Support contact: 1-800-524-1448

This device complies with part 15 of the FCC Rules.  
Operation is subject to the following two conditions:

(1) This device may not cause harmful interference, and (2) this device must accept any interference received, including interference that may cause undesired operation.

### FCC Note:

This equipment has been tested and found to comply with the limits for a class A digital device, pursuant to Part 15 of the FCC Rules. These limits are designed to provide reasonable protection against harmful interference when the equipment is operated in a commercial environment. This equipment generates, uses, and can radiate radio frequency energy, and if not installed and used in accordance with the instruction manual, may cause harmful interference to radio communications. Operation of this equipment in a residential area is likely to cause harmful interference in which case the user will be required to correct the interference at his own expense.

### Warning:

To assure continued FCC emission limit compliance, the user must use only shielded interface cables when connecting to external units. Also, any unauthorized changes or modifications to this equipment could void the user's authority to operate it.

 indicates safety information.

The symbols on this product (including the accessories) represent the following:

 DC

## TO REMOVE BATTERY

### Back-up Battery (Lithium Battery)

- For the removal of the battery for disposal at the end of its service life, please consult your dealer.

# Read this first! (For AW-UE160WPC, AW-UE160KPC)

## WARNING:

- To reduce the risk of fire or electric shock, do not expose this equipment to rain or moisture.
- To reduce the risk of fire or electric shock, keep this equipment away from all liquids. Use and store only in locations which are not exposed to the risk of dripping or splashing liquids, and do not place any liquid containers on top of the equipment.

## WARNING:

Always keep the main unit mounting screw, bracket mounting screws and drop-prevention wire mounting screw out of the reach of infants and small children.

## WARNING:

Installation should only be performed by qualified installation personnel.  
Improper installation may result in the entire apparatus falling down and causing injury.

## CAUTION:

Do not remove panel covers by unscrewing.  
To reduce the risk of electric shock, do not remove the covers.  
No user serviceable parts inside.  
Refer servicing to qualified service personnel.

## CAUTION:

In order to maintain adequate ventilation, do not install or place this unit in a bookcase, built-in cabinet or any other confined space. To prevent risk of electric shock or fire hazard due to overheating, ensure that curtains and any other materials do not obstruct the ventilation.

## CAUTION:

To reduce the risk of fire or electric shock and annoying interference, use the recommended accessories only.

## CAUTION:

Check the installation at least once a year.  
An improper installation could cause the unit to fall off resulting in personal injury.

## CAUTION:

To reduce the risk of fire or electric shock caused by damage to the power supply cord, do not squeeze, bend, or pull the power supply cord when using the apparatus.

## CAUTION:

A coin type battery is installed inside of the unit.  
Do not expose the unit to excessive heat such as sunshine, fire or the like.

 indicates safety information.

## FCC NOTICE (USA)

### Supplier's Declaration of Conformity

Model Number: AW-UE160WPC/AW-UE160KPC

Trade Name: Panasonic

Responsible Party: Panasonic Corporation of North America

Two Riverfront Plaza, Newark, NJ 07102

Support contact: 1-800-524-1448

This device complies with part 15 of the FCC Rules.

Operation is subject to the following two conditions:

(1) This device may not cause harmful interference, and (2) this device must accept any interference received, including interference that may cause undesired operation.

### FCC Note:

This equipment has been tested and found to comply with the limits for a class A digital device, pursuant to Part 15 of the FCC Rules. These limits are designed to provide reasonable protection against harmful interference when the equipment is operated in a commercial environment. This equipment generates, uses, and can radiate radio frequency energy, and if not installed and used in accordance with the instruction manual, may cause harmful interference to radio communications. Operation of this equipment in a residential area is likely to cause harmful interference in which case the user will be required to correct the interference at his own expense.

### Warning:

To assure continued FCC emission limit compliance, the user must use only shielded interface cables when connecting to external units. Also, any unauthorized changes or modifications to this equipment could void the user's authority to operate it.

 indicates safety information.

## NOTIFICATION (Canada)

CAN ICES-003 (A)/NMB-003(A)

The symbols on this product (including the accessories) represent the following:

 DC

## TO REMOVE BATTERY

### Back-up Battery (Lithium Battery)

- For the removal of the battery for disposal at the end of its service life, please consult your dealer.

Battery recycling symbol (valid only in Taiwan)

臺灣限定的廢電池回收標識。



廢電池請回收

**WARNING:**

- To reduce the risk of fire or electric shock, do not expose this equipment to rain or moisture.
- To reduce the risk of fire or electric shock, keep this equipment away from all liquids. Use and store only in locations which are not exposed to the risk of dripping or splashing liquids, and do not place any liquid containers on top of the equipment.

**WARNING:**

Always keep the main unit mounting screw, bracket mounting screws and drop-prevention wire mounting screw out of the reach of infants and small children.

**WARNING:**

This equipment is compliant with Class A of CISPR 32. In a residential environment this equipment may cause radio interference.

**WARNING:**

Installation should only be performed by qualified installation personnel. Improper installation may result in the entire apparatus falling down and causing injury.

**CAUTION:**

Do not remove panel covers by unscrewing. To reduce the risk of electric shock, do not remove the covers. No user serviceable parts inside. Refer servicing to qualified service personnel.

**CAUTION:**

In order to maintain adequate ventilation, do not install or place this unit in a bookcase, built-in cabinet or any other confined space. To prevent risk of electric shock or fire hazard due to overheating, ensure that curtains and any other materials do not obstruct the ventilation.

**CAUTION:**

To reduce the risk of fire or electric shock and annoying interference, use the recommended accessories only.

**CAUTION:**

Check the installation at least once a year. An improper installation could cause the unit to fall off resulting in personal injury.

**CAUTION:**

A coin type battery is installed inside of the unit. Do not expose the unit to excessive heat such as sunshine, fire or the like.

 indicates safety information.

The symbols on this product (including the accessories) represent the following:

 DC

**TO REMOVE BATTERY**

**Back-up Battery (Lithium Battery)**

- For the removal of the battery for disposal at the end of its service life, please consult your dealer.

## Read this first! (For AW-UE160WE, AW-UE160KE)

### EMC NOTICE FOR THE PURCHASER/USER OF THE APPARATUS

#### 1. Pre-requisite conditions to achieving compliance with the above standards

##### <1> Peripheral equipment to be connected to the apparatus and special connecting cables

- The purchaser/user is urged to use only equipment which has been recommended by us as peripheral equipment to be connected to the apparatus.
- The purchaser/user is urged to use only the connecting cables described below.

##### <2> For the connecting cables, use shielded cables which suit the intended purpose of the apparatus.

- Video signal connecting cables  
Use double shielded coaxial cables, which are designed for 75-ohm type high-frequency applications, for SDI (Serial Digital Interface).  
Coaxial cables, which are designed for 75-ohm type high-frequency applications, are recommended for analog video signals.
- Audio signal connecting cables  
If your apparatus supports AES/EBU serial digital audio signals, use cables designed for AES/EBU.  
Use shielded cables, which provide quality performance for high-frequency transmission applications, for analog audio signals.
- Other connecting cables (IEEE1394, USB)  
Use double shielded cables, which provide quality performance for high-frequency applications, as connecting cables.
- When connecting to the DVI signal terminal, use a cable with a ferrite core.
- If your apparatus is supplied with ferrite core(s), they must be attached on cable(s) following instructions in this manual.

#### 2. Performance level

The performance level of the apparatus is equivalent to or better than the performance level required by these standards.

However, the apparatus may be adversely affected by interference if it is being used in an EMC environment, such as an area where strong electromagnetic fields are generated (by the presence of signal transmission towers, cellular phones, etc.). In order to minimize the adverse effects of the interference on the apparatus in cases like this, it is recommended that the following steps be taken with the apparatus being affected and with its operating environment:

1. Place the apparatus at a distance from the source of the interference.
2. Change the direction of the apparatus.
3. Change the connection method used for the apparatus.
4. Connect the apparatus to another power outlet where the power is not shared by any other appliances.

#### Turkey Only

**AEEE Yönetmeliğine Uygundur.  
AEEE Complies with Directive of Turkey.**



#### WARNING:

**THIS PRODUCT CONTAINS A COIN BATTERY**



Keep coin battery out of the reach of infants and small children whether the battery is new or used. Severe or fatal injuries can occur within 2 hours of ingestion. Seek medical attention immediately.



#### Disposal of Old Equipment

##### Only for European Union and countries with recycling systems

This symbol on the products, packaging, and/or accompanying documents means that used electrical and electronic products must not be mixed with general household waste.

For proper treatment, recovery and recycling of old products, please take them to applicable collection points in accordance with your national legislation.

By disposing of them correctly, you will help to save valuable resources and prevent any potential negative effects on human health and the environment. For more information about collection and recycling, please contact your local municipality, dealer or supplier. Penalties may be applicable for incorrect disposal of this waste, in accordance with national legislation.

#### Manufactured by:

Panasonic Connect Co., Ltd.  
4-1-62 Minoshima, Hakata-ku, Fukuoka 812-8531, Japan

#### Importer:

Panasonic Connect Europe GmbH  
Hagenauer Strasse 43, 65203 Wiesbaden, Germany

#### Authorized Representative in EU:

Panasonic Connect Europe GmbH  
Panasonic Testing Centre  
Winsbergring 15, 22525 Hamburg, Germany

#### Importer for UK:

Panasonic Connect UK,  
a branch of Panasonic Connect Europe GmbH,  
Maxis 2, Western Road, Bracknell, Berkshire, RG12 1RT

**UK  
CA**

**Інформація для покупця**

Виробник:	Panasonic Connect Co., Ltd.	Панасонік Коннект Ко., Лтд.
Адреса виробника:	Fukuoka, Japan	Фукуока Японія
Країна походження:	Japan/China	Японія/Китай

Імпортер:	ТОВ "ПАНАСОНІК УКРАЇНА ЛТД"	
Адреса імпортера:	вул. Васильківська, буд. 30, м. Київ 03022, Україна	

**Примітки:**

Термін служби виробу	7 років
----------------------	---------

Дата виготовлення може бути визначена за допомогою комбінації літер та цифр серійного номера, розташованого на продукті.

Приклад: X X XXXXXXX

Рік: остання цифра року (7 – 2017, 8 – 2018,...0 – 2020)
Місяць: А – Січень, В – Лютий... L – Грудень

**Information for Users in India**

Information on hazardous constituents as specified in the E-Waste (Management) Rules in electrical and electronic equipment. Declaration of Conformity with the requirements of the E-Waste (Management) Rules limits with respect to Lead, Mercury, Cadmium, Hexavalent chromium, Polybrominated biphenyls, Polybrominated diphenyl ethers.

The content of hazardous substance with the exemption of the applications listed in the E-Waste (Management) Rules:

1. Lead (Pb) – not over 0.1% by weight.
2. Cadmium (Cd) – not over 0.01% by weight.
3. Mercury (Hg) – not over 0.1% by weight.
4. Hexavalent chromium (Cr6+) – not over 0.1% by weight.
5. Polybrominated biphenyls (PBBs) – not over 0.1% by weight.
6. Polybrominated diphenyl ethers (PBDEs) – not over 0.1% by weight.



For the purpose of recycling to facilitate effective utilization of resources, please return this product to a nearby authorized collection center, registered dismantler of recycler, or Panasonic service center when disposing of this product.

Customer care number (Toll free) : 1800 103 1333 ,1800 108 1333

Please see the Panasonic website for further information on collection centers, etc. or call the customer care toll-free number.

<https://www.panasonic.com/in/corporate/e-waste-management.html>

Do's & Don'ts		
No.	Do's	Don'ts
1	All electrical and electronic products are required to be handed over only to the Authorized recycler.	The product should not be opened by the user himself / herself, but only by authorized service personnel.
2	The product should be handed over only to authorized recycler for disposal.	The product is not meant for re-sale to any unauthorized agencies / scrap dealers / kabariwalas.
3	Keep the product in an isolated area, after it becomes non-functional / unrepairable so as to prevent its accidental breakage.	The product is not meant for mixing into household waste stream.
4	Refer to Operating Instructions for handling of end of life products.	Do not keep any replaced spare part(s) from the product in an exposed area.
5	Always dispose of products that have reached end of life at Panasonic Life Solutions India Authorized Service Centre.	Do not donate old electronic items to anybody. Do not dispose of your product in garbage bins along with municipal waste that ultimately reaches landfill.
6	Wherever possible or as instructed, separate the packaging material according to responsible waste disposal options and sorting for recycling.	Do not give e-waste to informal and unorganized sectors like Local Scrap Dealers / Rag Pickers.

# Read this first!

## Note on grounding

- Ground the unit via the <SIGNAL GND> ground connector.

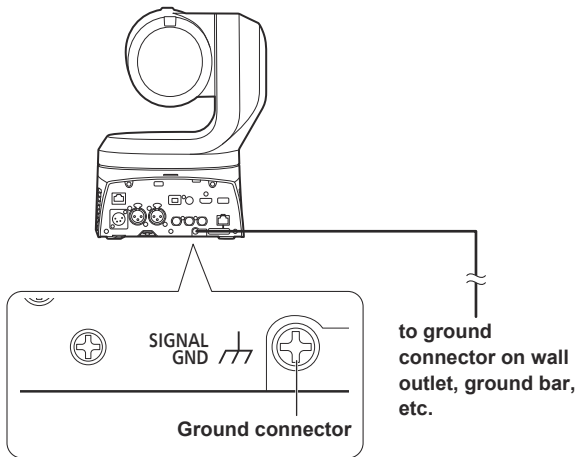

## Trademarks and registered trademarks

- Microsoft®, Windows®, Windows® 10, Microsoft Edge, Internet Explorer®, ActiveX® and DirectX® are either registered trademarks or trademarks of Microsoft Corporation in the United States and other countries.
- Apple, Mac, macOS, iPadOS, iPhone, iPad, and Safari are registered trademarks of Apple Inc., in the United States and other countries.
- Android™ and Chrome™ browser are trademarks of Google LLC.
- Intel® and Intel® Core™ are trademarks or registered trademarks of Intel Corporation in the United States and other countries.
- Adobe® and Reader® are either registered trademarks or trademarks of Adobe Systems Incorporated in the United States and/or other countries.
- The terms HDMI and HDMI High-Definition Multimedia Interface, and the HDMI Logo are trademarks or registered trademarks of HDMI Licensing Administrator, Inc. in the United States and other countries.
- NDI is a registered trademark of NewTek, Inc. in the United States.
- Other names of companies and products contained in these Operating Instructions may be trademarks or registered trademarks of their respective owners.

## About copyright and licence

It is expressly prohibited to distribute, copy, disassemble, reverse compile, modify, reverse engineer, or export in violation of export laws the software provided with the unit.

## Abbreviations

The following abbreviations are used in this manual.

- Windows® Internet Explorer® 11 32/64-bit is abbreviated to "Internet Explorer".

For the purposes of this manual, the model numbers of the units are given as listed in the table below.

Model number of unit	Model number given in manual
AW-UE160WP, AW-UE160KP, AW-UE160WPC, AW-UE160KPC, AW-UE160WE, AW-UE160KE, AW-UE160WED, AW-UE160KED	<b>AW-UE160</b>
AW-RP150G	<b>AW-RP150</b>
AW-RP60G	<b>AW-RP60</b>
AV-HLC100P, AV-HLC100E	<b>AV-HLC100</b>
AV-UHS500P, AV-UHS500E	<b>AV-UHS500</b>

## Illustrations and screen displays featured in the manual

- What is shown in the manual's illustrations and screen displays may differ from how it is actually appears.
- Functions only available with Microsoft Edge (IE mode) are indicated with the **Microsoft Edge (I.E. Mode)** symbol.
- The screenshots are used in accordance with the guidelines of Microsoft Corporation.



# Contents

Read this first! (For AW-UE160WP, AW-UE160KP) .....	2	FILES .....	81
Read this first! (For AW-UE160WPC, AW-UE160KPC) .....	3	MAINTENANCE .....	81
Read this first! (For AW-UE160WE, AW-UE160KE, AW-UE160WED, AW-UE160KED) .....	5	<b>Camera menu item table .....</b>	<b>84</b>
Read this first! (For AW-UE160WE, AW-UE160KE) .....	6	<b>Displaying the web screen .....</b>	<b>101</b>
Read this first! .....	8	Displaying the web screen using a personal computer .....	101
Note on grounding .....	8	Switching between the Live screen [Live] and Web setup screen [Setup] .....	103
<b>Before use .....</b>	<b>10</b>	Logging into the Web screen .....	103
Overview .....	10	<b>Web screen operations .....</b>	<b>104</b>
Computer requirements .....	10	Live screen [Live] .....	104
Disclaimer of warranty .....	11	<b>Web screen configurations .....</b>	<b>110</b>
Network security .....	11	Web setup screen [Setup] .....	110
<b>Features .....</b>	<b>12</b>	Setting status screen [Setting status] .....	112
<b>Accessories .....</b>	<b>14</b>	System screen [System] .....	112
How to remove the lens cap .....	14	Image screen [Image/Audio] .....	125
<b>Optional accessories .....</b>	<b>14</b>	Collaboration capability [Linkage] .....	164
<b>Operating precautions .....</b>	<b>15</b>	User management screen [User mng.] .....	167
<b>Wireless remote control (optional accessory) .....</b>	<b>17</b>	Network setup screen [Network] .....	169
<b>Parts and their functions .....</b>	<b>18</b>	Maintenance screen [Maintenance] .....	186
Camera unit .....	18	<b>Displaying the web screen using a personal computer equipped   with a touch panel .....</b>	<b>190</b>
Wireless remote control: AW-RM50AG (optional accessory) .....	31	<b>Displaying the web screen using a mobile terminal .....</b>	<b>192</b>
<b>Setting the remote control IDs .....</b>	<b>32</b>	Camera control screen [Camera Control] .....	192
<b>Network settings .....</b>	<b>33</b>	<b>Limiters .....</b>	<b>194</b>
Using EasyIP Setup Tool Plus to make settings for the unit .....	33	<b>Setting/releasing the limiters .....</b>	<b>195</b>
Setting the initial account .....	34	Basic limiter operations .....	195
Installing the plug-in viewer software .....	35	Setting the limiters .....	195
<b>Basic shooting operations .....</b>	<b>36</b>	Releasing the limiters .....	195
<b>How to turn the power on and off .....</b>	<b>37</b>	Resetting the limiters .....	195
Turning the power on .....	37	<b>Safe mode .....</b>	<b>196</b>
Turning the power off .....	37	Concerning the safe mode .....	196
<b>Selecting the units .....</b>	<b>38</b>	Detection of equipment trouble .....	196
<b>Shooting .....</b>	<b>39</b>	<b>Troubleshooting .....</b>	<b>197</b>
<b>What to do when encountering problems in the basic shooting   operations .....</b>	<b>40</b>	<b>Specifications .....</b>	<b>205</b>
<b>More advanced operations .....</b>	<b>41</b>	<b>Index .....</b>	<b>208</b>
<b>Manual shooting .....</b>	<b>42</b>		
Manually adjusting the focus .....	42		
Manually adjusting the iris .....	42		
Manually adjusting the shutter speed .....	42		
Manually adjusting the gain .....	42		
<b>Preset memories .....</b>	<b>43</b>		
<b>White balance adjustment .....</b>	<b>44</b>		
Automatic adjustment (AWB: AWB A or AWB B) .....	44		
Auto tracking white adjustment (ATW) .....	45		
3200K and 5600K presets .....	45		
VAR .....	45		
<b>Black balance adjustment .....</b>	<b>46</b>		
Automatic adjustment .....	46		
<b>Black level (master pedestal) adjustment .....</b>	<b>46</b>		
<b>Genlock adjustment .....</b>	<b>47</b>		
Horizontal phase adjustment .....	47		
<b>Camera menu items .....</b>	<b>48</b>		
Top Menu screen .....	48		
BASIC CONFIG .....	48		
NETWORK .....	51		
OUTPUT .....	52		
RETURN .....	56		
AUDIO .....	56		
IP SIGNAL .....	57		
PAINT .....	58		
LENS .....	69		
MONITOR DISPLAY .....	70		
TRACKING DATA OUTPUT .....	71		
CROP .....	72		
PAN/TILT .....	74		
PRESET .....	77		

# Before use

## Overview

- This product is an all-in-one pan-tilt head remote camera, compatible with 4K/12G-SDI and SMPTE ST2110\*1, and also compatible with 4K/60p and 2K/120p.
  - \*1 A separate optional software key (AW-SFU60) needs to be purchased to enable SMPTE ST2110 functionality. Use EasyIP Setup Tool Plus to activate AW-SFU60. Refer to the operating instructions available on the EasyIP Setup Tool Plus download page for activation instructions.
- High sensitivity, high resolution (1600), and high image quality achieved with the 4K-compatible newly developed MOS sensor and image processing engine. Furthermore, recording scenes in a variety of situations is made possible with the 20x optical zoom lens, image stabilization and night mode functions, Low Pass Filter to reduce moiré effects, and image plane phase-difference detection AF (PDAF)\*2 which achieves AF that reduces hesitation by being fast and precise.
  - \*2 PDAF: Phase Detection Auto Focus
- This product is compatible with High Bandwidth NDI (hereafter, NDI) and NDI|HX technology of NewTek, Inc. The problem of IP transmission delay and image degradation of NDI|HX will be resolved with High Bandwidth NDI.
- Still image precision has been improved for Pan/Tilt by the inclusion of a newly developed optical encoder.
- The unit supports transmission of video to NewTek High Bandwidth NDI and NDI|HX compatible software applications and hardware devices over a network.
- By connecting a controller, smooth camera operation via IP control is made possible.
- The unit features a night mode that exposes subjects to infrared rays, making it possible to shoot even under low-light conditions.
- When the unit is connected to a personal computer via an IP network, it can be operated via a web browser.
- Equipped with a variety of 4K interfaces and also with multiple 3G-SDI outputs individually fitted, this camera can flexibly adapt to a wide range of applications as a remote camera compatible with 4K.
- The unit is available in pearl white (AW-UE160WP/AW-UE160WPC/AW-UE160WE/AW-UE160WED) or black (AW-UE160KP/AW-UE160KPC/AW-UE160KE/AW-UE160KED) to suit your intended application and environment.

## Computer requirements

<b>CPU</b>	7th Generation Intel® Core™ (Kaby Lake or later) recommended
<b>Memory</b>	<b>For Windows:</b> 4 GB or more <b>For Mac:</b> 4 GB or more
<b>Network function</b>	100BASE-T/TX or 1000BASE-T, RJ-45 connector
<b>Image display</b>	Resolution: 1920 × 1080 pixels or more Color generation: True Color 24-bit or more
<b>Supported operating systems and web browsers</b>	<b>For Windows:</b> Microsoft® Windows® 10  Microsoft Edge Google Chrome
	<b>For Mac:</b> macOS13 macOS12 Safari Google Chrome
	<b>For iPhone, iPad:</b> iOS Safari iPadOS
	<b>For Android:</b> Android OS Google Chrome
<b>Other</b>	Adobe® Reader® (for viewing the operating instructions available on the website)

### IMPORTANT

- Failure to provide the required personal computer environment may slow down the delineation of the images on the screen, make it impossible for the web browser to work and cause other kinds of problems.

### <NOTE>

- Depending on the software version of the unit, an update may be necessary.
- For the latest information on compatible operating systems and web browsers, visit the support page at the following website.

<https://pro-av.panasonic.net/en/>

### Disclaimer of warranty

IN NO EVENT SHALL Panasonic Connect Co., Ltd. BE LIABLE TO ANY PARTY OR ANY PERSON, EXCEPT FOR REPLACEMENT OR REASONABLE MAINTENANCE OF THE PRODUCT, FOR THE CASES, INCLUDING BUT NOT LIMITED TO BELOW:

- ① ANY DAMAGE AND LOSS, INCLUDING WITHOUT LIMITATION, DIRECT OR INDIRECT, SPECIAL, CONSEQUENTIAL OR EXEMPLARY, ARISING OUT OF OR RELATING TO THE PRODUCT;
- ② PERSONAL INJURY OR ANY DAMAGE CAUSED BY INAPPROPRIATE USE OR NEGLIGENT OPERATION OF THE USER;
- ③ UNAUTHORIZED DISASSEMBLE, REPAIR OR MODIFICATION OF THE PRODUCT BY THE USER;
- ④ INCONVENIENCE OR ANY LOSS ARISING WHEN IMAGES ARE NOT DISPLAYED, DUE TO ANY REASON OR CAUSE INCLUDING ANY FAILURE OR PROBLEM OF THE PRODUCT;
- ⑤ ANY PROBLEM, CONSEQUENTIAL INCONVENIENCE, OR LOSS OR DAMAGE, ARISING OUT OF THE SYSTEM COMBINED BY THE DEVICES OF THIRD PARTY;
- ⑥ ANY DEMANDS FOR COMPENSATION, CLAIMS, ETC. OCCASIONED BY THE INFRINGEMENT OF PRIVACY BY INDIVIDUALS OR ORGANIZATIONS WHOSE IMAGES WERE SHOT BY THE USER BECAUSE THESE IMAGES (INCLUDING THE RECORDINGS MADE) WERE MADE AVAILABLE BY THE USER BECAUSE IN THE PUBLIC DOMAIN FOR SOME REASON OR OTHER OR BECAUSE THE IMAGES ENDED UP BEING USED FOR PURPOSES OTHER THAN THE ONE DESCRIBED ABOVE;
- ⑦ LOSS OF REGISTERED DATA CAUSED BY ANY FAILURE.

### Network security

As the unit intended to be used while connected to a network, the following security risks exist.

- ① Leakage or theft of information through the unit
- ② Unauthorized operation of the unit by persons with malicious intent
- ③ Interference with or stoppage of the unit by persons with malicious intent

It is your responsibility to take precautions, such as those described below, to protect yourself against the above network security risks. Panasonic does not accept any responsibility for damage of this type.

- Use the unit in a network secured by a firewall, etc.
- If the unit is connected to a network that includes personal computers, make sure that the system is not infected by computer viruses or other malicious programs (using a regularly updated antivirus program, anti-spyware program, etc.).
- Protect your network against unauthorized access by restricting users to those who log in with an authorized user name and password.
- After accessing the unit as an administrator, be sure to close all web browsers.
- Change the administrator password periodically.
- To avoid passwords that can be guessed easily by third parties, set a password of at least 8 characters in length, including at least 3 different types of characters, such as upper case, lower case, numbers, and symbols.
- Restrict access to the unit by authenticating the users, for example, to prevent setting information stored on the unit from leaking over the network.
- Do not install the unit in locations where the unit, cables, and other parts can be easily damaged or destroyed by persons with malicious intent.
- Avoid connections that use public lines.

### <NOTE>

#### Notes on user authentication

- User authentication on the unit can be performed via digest authentication or basic authentication. If basic authentication is used without the use of a dedicated authentication device, password leaks may occur. We recommend using digest authentication or host authentication.

#### Usage restrictions

- We recommend connecting the unit, controller, and any computers to the same network segment. Events based on settings inherent to the network devices, for example, may occur in connections that include different segments, so be sure to perform checks prior to operation.
- When using a Panasonic controller (AW-RP150, AW-RP60), set [Wait time mode] to [Mode2] when using digest authentication. (→ page 167)  
Smooth operation may be diminished when [Wait time mode] is set to [Mode1].

# Features

## ■ Compatible with 4K/HD formats

- You can switch between the following formats via the camera menus or a web browser.

### [4K format]

2160/60p, 2160/59.94p, 2160/50p, 2160/29.97p\*1, 2160/25p\*1, 2160/24p\*1, 2160/23.98p\*1

### [HD format]

1080/119.88p, 1080/100p, 1080/60p, 1080/59.94p, 1080/50p, 1080/29.97p\*1, 1080/25p\*1, 1080/24p\*1, 1080/23.98p\*1, 1080/59.94i, 1080/50i, 720/59.94p, 720/50p

\*1 Native output

## ■ Equipped with 1-inch\*2 4K new MOS sensor and new image engine

- Equipped with a large, newly developed 1-inch\*2 4K MOS sensor that achieves F11/2000lx [Normal] and F14/2000lx [Low Light] sensitivity. Low-noise recording made possible even in low-light conditions.

\*2 Effective size

## ■ Fitted with a wide-angle optical zoom lens, horizontal to 75.1°, and magnification to 20 times

- The entire subject can be taken widely even if the camera is close to the subject.
- Even subjects far away can be captured clearly.

## ■ Easy operation of unit enabled by its integration with a high-performance pan-tilt head unit

- Operations at the high speed of 180°/s
- With a pan range of ±175° and a tilt range of between -30° to 210°, the camera supports a wide range of movement.
- Quiet operation under noise level NC35 is possible (under NC25 during pan/tilt pause).
- Storage of up to 100 positions in the preset memory

## ■ Built-in night mode

- The unit supports infrared shooting.  
By exposing subjects to infrared rays, shooting under ordinarily difficult low-light conditions is possible.  
(Image output will be in black and white.)
- The iris will be fixed at open.

## ■ IP image output functions

- The unit is equipped with image compression and IP transmission LSI capabilities. Output in 4K quality at up to 60 fps.
- Compatible as standard with SRT (Secure Reliable Transport) and High bandwidth NDI/NDI|HX to enable the secure transfer of images at high quality and low-latency even over public telecommunications lines.
- Operation with IP control allows for a wide range of applications, such as controlling the camera from remote locations.

## ■ Compatible with the FreeD protocol, enabling the building of an AR/VR system

- By outputting commands that conform with the FreeD protocol, it is possible to connect with an AR/VR system.
- Camera tracking data (pan and tilt, zoom, focus, iris) is output together with synchronizing signals, making it possible to easily build a system without an encoder.

### <NOTE>

- FreeD is a protocol for outputting the camera tracking data for AR/VR systems.

## ■ Equipped with PDAF (Phase Detection Auto Focus) functionality

- Employing a method of combining image plane phase-difference detection AF and contrast AF, we have achieved a new AF that is fast and precise, with reduced hesitation.

## ■ Equipped with HFR (High Frame Rate) functionality

- Performing high-speed recording at FHD/120fps makes it possible to record slow motion video that is both smooth and attractive.

## ■ Equipped with Low Pass Filter as standard

- The optical Low Pass Filter greatly reduces the moiré effects apparent on LED/LCD panels during recording.

## ■ Compatible with SMPTE ST2110

- This is a specification for high-quality IP transmission of images for use in the production of broadcast images. The camera can support up to 2K/60p uncompressed transmission if you purchase an optional software key (AW-SFU60) and optical transceiver (commercially available).  
Use EasyIP Setup Tool Plus to activate AW-SFU60. Refer to the operating instructions available on the EasyIP Setup Tool Plus download page for activation instructions.

## ■ Equipped with XLR connectors (2ch) for audio input

- There are two channels so that you can use high performance microphones on either side of a venue for audio input. This gives you the capability of recording in places such as live houses and theaters where acoustics are valued.

## ■ Easy connections and settings courtesy of IP control

- Up to two hundred units can be operated by IP connection from a Panasonic controller (AW-RP150, AW-RP60).  
(The maximum length of the LAN cables is 100 meters (328 ft).)
- Network connection with AW-RP150 or AW-RP60 requires setup of an initial account. (→ page 34)  
When an initial account is not set up, AW-RP150 or AW-RP60 can detect but cannot control this unit.
- When using a Panasonic controller (AW-RP150, AW-RP60), set [Wait time mode] to [Mode2] when using digest authentication. (→ page 167)  
Smooth operation may be diminished when [Wait time mode] is set to [Mode1].

### ■ Use of easy-to-operate wireless remote control (optional accessory) is possible

- A wireless remote control capable of operating up to four units can be used.

It can easily be used to set the various functions or switch between them while viewing the menu screens.

### ■ Flexible camera layout enabled by simple connection and installation

- This unit features excellent connectivity and installability thanks to the IP control; a lightweight main unit, and the turn-lock mechanism, which enables the user to install it on his or her own (only when used indoors).

#### <NOTE>

- Bear in mind that this unit is designed to be used indoors only: It cannot be used outdoors.

### ■ PoE++ \*1 eliminates need for camera power configurations

- Configurations for camera's power supply are not necessary when the unit is connected to a network device that supports the PoE++ standard (IEEE 802.3bt compliant)\*2.

Software authentication (LLDP) is also supported, but it may be necessary to make settings on the network device (IEEE 802.3bt compliant)\*2.

#### <NOTE>

- If the external DC power supply and a PoE++ power supply are connected simultaneously, the external DC power supply will have priority. If the external DC power supply is disconnected while both power supplies are connected, the unit will restart automatically, and the image will be interrupted.
- Use a Category 5e cable or higher when using a PoE++ power supply. The maximum length of the cable between the power supply unit and the unit is 100 meters (328 ft). Using a cable that is lower than Category 5e may result in reduced power supply capabilities.



\*1 Power over Ethernet Plus Plus. Referred to as "PoE++" in this manual.

\*2 For details on PoE++ power supply devices for which operation has been verified, consult your local dealer.

## Accessories

Check that the following accessories are present and accounted for.

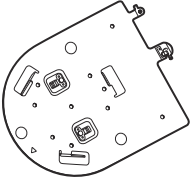
- After removing the product from its container, dispose of the power cable cap (if supplied) and packing materials in an appropriate manner.

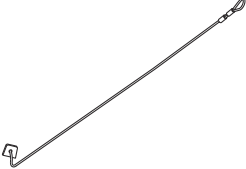
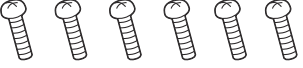
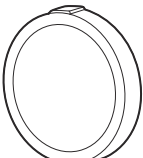
<p><b>Mount bracket for installation surface (Hanging/Desktop) (1)</b></p> 	<p><b>Main unit mounting screw (with flat washer, spring washer) M3×6 mm (1/4 inches) (1)</b></p> 	<p><b>Drop-prevention wire (1) Drop-prevention wire mounting screw (1) (comes attached to the unit)</b></p> 
<p><b>Bracket mounting screws (bind-head) M4×10 mm (13/32 inches) (6)</b></p> 	<p><b>Lens cap (1) (comes attached to the unit)</b></p> 	

### How to remove the lens cap

Move the lens cap in the direction of the arrow to remove.

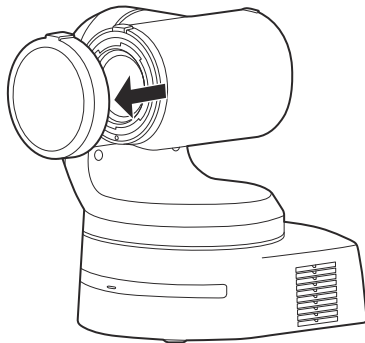

## Optional accessories

- **Wireless remote control AW-RM50AG (Size “AA” dry battery x 2, obtained separately)**

<NOTE>

- For details on optional accessories, refer to the catalog or consult your local dealer.

# Operating precautions

## ■ Do not use the unit in oily-smoky or dusty places.

Performance may be adversely affected if small particles or other foreign objects get inside the product.

Take extra care in environments where a special effect such as theatrical smoke is used.

## ■ Do not allow foreign matter to make contact with the rotating parts.

Failure to obey may cause the unit to malfunction.

## ■ Maintenance

Turn off the unit's power before proceeding with maintenance. Failure to obey may result in injuries.

Wipe the surfaces using a soft dry cloth. Avoid all contact with benzine, paint thinners and other volatile substances, and avoid using these substances. Otherwise, the casing may become discolored.

## ■ Hold the bottom surface with both hands for picking up this unit.

If you hold the lens part or the sides, it will put a load strain on the motor and cause a malfunction.

## ■ Do not turn the camera head by hand.

Turning the camera head by hand may cause the unit to malfunction.

## ■ About the lens/pan-tilt head

If the lens, pan-tilt head, and other parts are not operated for a long period of time, the viscosity of the grease applied inside them may increase and operation may become no longer possible. Move the lens and pan/tilt head regularly.

## ■ Shoot under the proper lighting conditions.

To produce pictures with eye-pleasing colors, shoot under the proper lighting conditions.

The pictures may not appear with their proper colors when shooting under fluorescent lights. Select the proper lighting as required.

## ■ To ensure a stable performance in the long term

Using the unit for prolonged periods in locations where the temperature and humidity levels are high will cause its parts to deteriorate, resulting in a reduction of its service life.

(Recommended temperature: Max. 35 °C (95 °F))

Ensure that a cooling unit or heating unit will not blow any air directly toward the installation location.

## ■ Do not point the camera at strong lights.

When parts of the MOS sensor are exposed to spotlights or other strong lights, blooming (a phenomenon where the edges of strong lights become blurred) may occur.

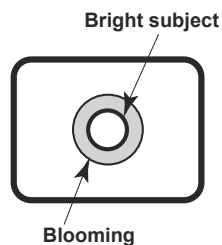

## ■ What happens with high-brightness subjects

Flare may occur if an extremely bright light source is pointed at the lens. In a case like this, change the angle or take some other remedial action.

## ■ When using the automatic functions

- In the "Scene" such as the camera menu, the initial settings on some items has been set to auto, making it impossible for these items to be operated manually. To operate them manually, switch from the auto settings to the manual settings as required.
- When using the ATW (auto tracking white adjustment) function under fluorescent lights, the white balance may vary.
- In some situations, it may be hard to focus at the auto setting. In cases like this, select the manual setting, and focus manually.

## ■ Zooming and focusing

When the focus is set manually, out-of-focusing may occur during zooming.

After zooming, if necessary, either adjust the focus or set the focus to auto.

When using the focus at the manual setting, proceed with zooming after setting the focus position at the Tele end where the focusing accuracy is higher. (However, if the distance from the unit to the subject is less than 1.2 meters (3.9 ft), the subject may shift out of focus at the Wide end.)

If zooming is performed to the Tele end after having adjusted the focus at the Wide end, out-of-focusing may occur.

## ■ Operation of the lens when the power is turned on

When the unit's power is turned on, the zoom, focus and iris are adjusted automatically.

## ■ The unit comes with the safe mode.

The safe mode is function designed to protect the unit from damage. For details, refer to "Concerning the safe mode" (→ page 196).

## ■ Concerning the HDMI interface standard

This unit has been certified as HDMI-compatible, but on rare occasions images may not be displayed depending on the HDMI device which has been connected to the unit.

## ■ Concerning USB

Use a USB cable conforming to the USB3.0 specification. We also recommend using a cable that is 1.5 m (4.9 ft) or shorter.

Operation is not guaranteed with a cable for USB2.0. This unit will need to be restarted if one is connected by mistake.

## ■ Color bars

Color bars are used to adjust the color phase, and the widths and positions of these bars may differ from other models.

## ■ H.264/H.265 patent pool licensing

This product is licensed based on the AVC Patent Portfolio License, and the license does not extend beyond uses by users, who engage in the acts described below, for their own personal and non-profit applications.

- (i) Recording of image information in compliance with the AVC standard (hereafter, "AVC videos")
- (ii) Playing of AVC videos recorded by consumers engaging in personal activities or AVC videos acquired from licensed providers

For details, visit MPEG LA, LLC website (<http://www.mpegla.com>).



### ■ Concerning PoE++ power supply

The unit complies with the IEEE 802.3bt.  
Use a compatible Ethernet hub and PoE++ injector to use a PoE++ power supply.  
Software authentication (LLDP) complies with IEEE 802.3bt, but it may be necessary to make settings on the network device.  
For details on Ethernet hubs and PoE++ injectors for which operations have been verified, consult your local dealer.

### ■ Turn off the power before connecting or disconnecting the cables.

This unit is not equipped with a power switch.  
Turn off the DC 12 V power supply or PoE++ power supply device before connecting or disconnecting cables.

### ■ When the unit is not in use

Turn off the unit's power when it is not in use.  
When the unit is no longer going to be used, do not leave it lying around, but be absolutely sure to dispose of it properly.

### ■ Do not touch the optical system parts.

The optical system parts are vital to the operation of the camera. Under no circumstances must they be touched.  
In the unlikely event that they have become dusty, remove the dust by using a camera blower or by wiping them gently with a lens cleaning paper.

### ■ Do not point the camera directly at the sun or a laser beam no matter whether it is turned on or not.

Taking images of the sun, laser beams, or other brightly lit subjects for prolonged periods of time may damage the CCD.

### ■ Personal computer used

If the same image is displayed for a prolonged period on a personal computer's monitor, the monitor may be damaged. Use of a screen saver is recommended.

### ■ Concerning the IP address setting

Do not use EasyIP Setup Tool Plus on multiple personal computers to simultaneously set the IP address for a single camera.  
Otherwise, you will be unable to complete the proper procedure and set the IP address correctly.

### ■ Disposal of the unit

When the unit has reached the end of its service life and is to be disposed of, ask a qualified contractor to dispose of the unit properly in order to protect the environment.

### ■ Moving the unit

- When carrying the unit, take care not to apply strong shocks or drop it.
- Remove connection cables when moving the unit.
- Turn off the system power when moving the unit.
- Wrap the unit in cushioning material, etc., when moving the unit so that impacts do not damage it.
- Treat the unit carefully so that vibrations or impacts do not damage it.

### ■ Concerning the installation location

Install the unit in a stable location which will not be susceptible to shaking. If the unit is installed in a location which is susceptible to shaking, this will cause the unit's images to shake in turn.  
Install the unit after conferring in detail with your dealer.  
Install the unit on a ceiling that is strong enough (such as a concrete ceiling).  
If the unit is to be installed on a ceiling which is not strong enough, reinforce the ceiling sufficiently first.

Install this unit in a stable location where it will not be shaken and that has sufficient rigidity. Shaking of the installation location can be the cause of performance deterioration and malfunctions in the camera.

If the camera is installed in a location with insufficient stiffness, the pan and tilt control characteristics may be adversely affected, leading to unstable operation.

- In environments such as the following, there may be unusual operation sounds during pan and tilt, and operational errors may occur.

If you are concerned about unstable pan and tilt operations after installation, please contact your dealer.

#### <Installation examples that may cause performance deterioration and malfunctions>

- A Single point attachment to a cylindrical pole structure that has a small diameter
- B Single point attachment to a movable structure

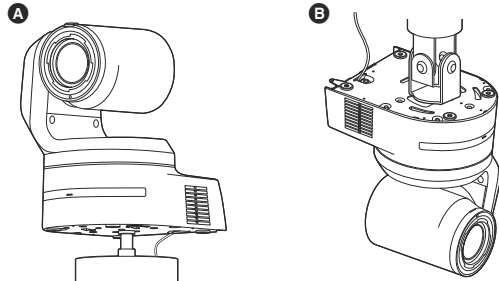

### ■ Information on software used with this product

This product includes GNU General Public License (GPL) and GNU Lesser General Public License (LGPL) licensed software, and the customer is entitled to obtain, modify, or redistribute the source code for the software.

This product includes MIT Licensed software.

This product includes BSD Licensed software.

For details on obtaining the source codes, visit the following website.

<https://pro-av.panasonic.net/en/>

However, do not contact Panasonic for questions regarding obtained source codes.



## Wireless remote control (optional accessory)

This unit can be operated by remote control using a wireless remote control (model number: AW-RM50AG) purchased separately.

Check out the following points before using the wireless remote control.

- Point the wireless remote control at the unit's wireless remote control signal light-sensing area (front panel or back panel), and operate it within a range of 10 meters (32.8 ft) from these areas.

- Refer to <Layout of wireless remote control signal light-sensing areas> on the right.

- The signal sensing distance is reduced if the angle at which the wireless remote control signals are sensed is increased.

The light-sensing sensitivity is reduced to about one-half when the wireless remote control is pointed at an angle of 40 degrees from each position in front of a wireless remote control signal light-sensing area (front panel or back panel).

If the remote control is operated from the behind the unit, it may be either difficult or impossible to perform the desired operations.

- If the unit is installed near fluorescent lights, plasma monitors or other such products or if the unit is exposed to sunlight, the effects of the light may make it impossible for the unit to be operated using the wireless remote control.

Be sure to follow the steps below for installation and use.

- Take steps to ensure that the wireless remote control signal light-sensing area will not be exposed to the light from fluorescent lights, plasma monitors or other such products or from the sun.
- Install the unit away from fluorescent lights, plasma monitors and other such products.

- For about 10 minutes even after the batteries have been removed from the wireless remote control, the selection of the operation to be performed (the CAMERA <1> to <4> button which was pressed last) will remain stored in the memory.

When a longer period of time elapses, however, the selection is reset to the status established when the CAMERA <1> button was pressed.

### <Layout of wireless remote control signal light-sensing areas>

#### <NOTE>

- The arrows in the figure below show the light-sensing directions in which the wireless remote control signals travel.

Wireless remote control signal light-sensing area (back panel, 1 place)

Wireless remote control signal light-sensing area (front panel, 2 places)

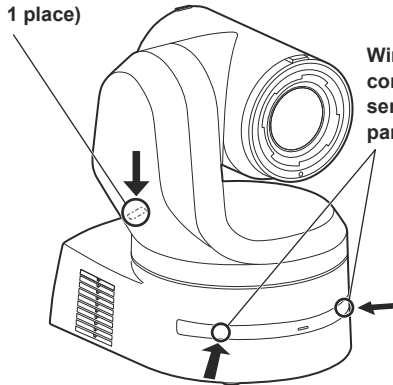

#### • Top view

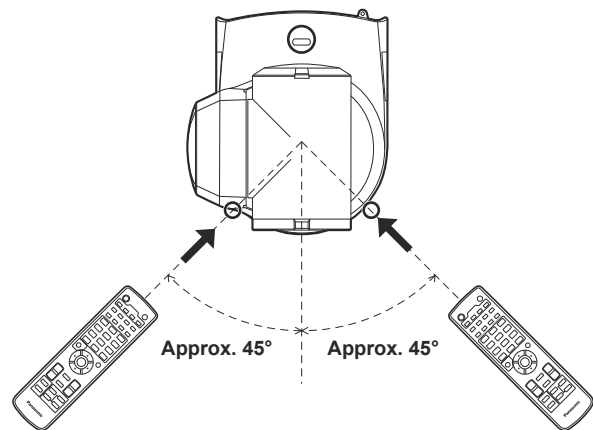

#### • Rear panel view

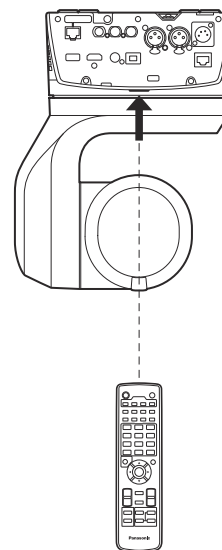

# Parts and their functions

## Camera unit

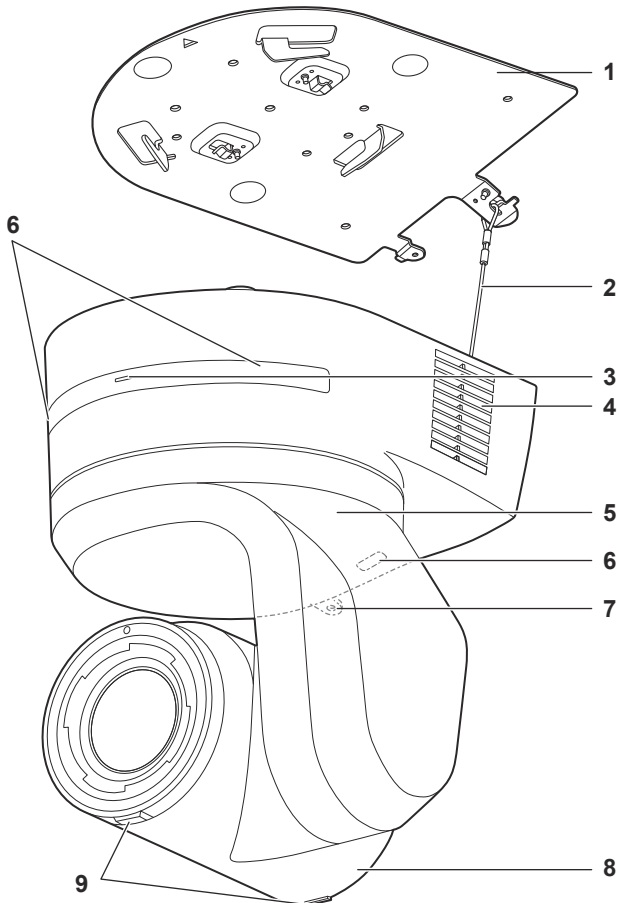

Rear panel

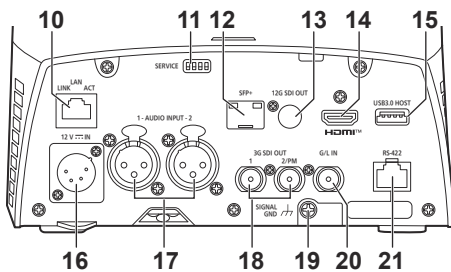

Bottom panel

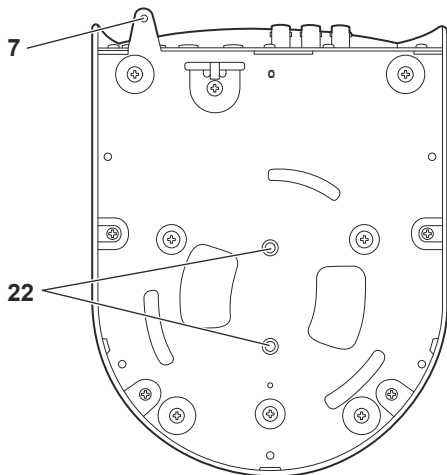

### 1. Mount bracket for installation surface (supplied accessory)

Mount this bracket onto the installation surface, and then attach the camera main unit to the bracket.

### 2. Drop-prevention wire

This wire is screwed down to the bottom panel of the camera main unit. Loop the circle part of the wire around the hook of the mount bracket.

### 3. Status display lamp

This lights in the following way depending on the status of the unit.

Orange	Light up	When the standby status is established
	Blink twice	When a signal not matched by the remote control ID has been received from the wireless remote control (optional accessory) while the power is on
	Blinking slowly	Firmware being updated (STEP 1: files being transferred)
	Blink three times rapidly	When the Identify function (a function that makes the status display lamp of a specified camera blink) of EasyIP Setup Tool Plus operates
Green	Light up	When the power is on
	Blink twice	When a signal matched by the remote control ID has been received from the wireless remote control (optional accessory) while the power is on
	Blinking rapidly	When the initialization process is complete
Red	Light up	When trouble has occurred in the unit
	Blinking slowly	Firmware being updated (STEP 2: data being written)
	Blinking rapidly	When a PoE++ software authentication error has occurred

### 4. Ventilation holes

Blocking the ventilation holes may cause a malfunction. Make sure there is sufficient space around the ventilation holes.

### 5. Tilt head

This rotates in the right and left direction.

### 6. Wireless remote control signal light-sensing area

The light-sensing area is provided in three places, on the front panel of the camera pedestal and at the top of the rear panel.

### 7. Hole for securing the camera pedestal

This hole is provided in the bottom panel of the camera pedestal.

### 8. Camera head

This rotates in the up and down direction.

### 9. Tally lamp

These turn on/turn off with control signals only when the tally lamp setting is "ON". The tally lamps light in three different colors; red, green, and yellow.

### 10. LAN connector for IP control <LAN LINK/ACT>

This LAN connector (RJ-45) is connected when exercising IP control over the unit from an external device. Use a LAN cable (category 5e or above, max STP 100 m (328 ft)) for connection.

## Parts and their functions (continued)

### 11. Service switches <SERVICE>

Perform switch settings before turning the unit on.

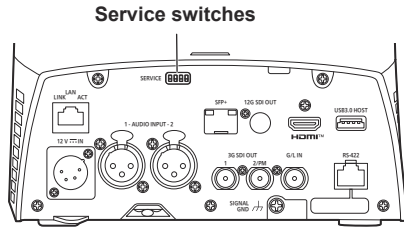

Function	Factory settings
SW1	OFF
SW2	Switches for initializing and initial settings (Refer to the explanations in "Initialization 1", "Initialization 2", "Direct start mode" )
SW3	OFF
SW4	OFF

#### Initialization 1

- Reset the user authentication settings and host authentication settings for network connection. (This will delete all the registered user information (IDs/passwords) and host information (IP addresses).)
- With the service switches set as shown below, turn on the power of the unit.



#### <NOTE>

- When initialization is complete, the status display lamp on the front of the unit blinks green. Set the service switches back to their original positions (SW1 to SW4 all OFF), then restart the unit.

#### Initialization 2

- The unit is reset to the state it was in at the time of purchase. (All camera menu setting values and network setting values are reset.)
- With the service switches set as shown below, turn on the power of the unit.



#### <NOTE>

- When initialization is complete, the status display lamp on the front of the unit blinks green. Set the service switches back to their original positions (SW1 to SW4 all OFF), then restart the unit.
- When initialization is complete, output images may be disrupted. When you reset the service switches back to their original positions and restart the unit, the image disruption should be resolved.

#### Direct start mode

- When the power of the unit is turned on, the pan-tilt head (tilt) is not returned to horizontal as part of the lens initializing operation. Use when the tilt cannot be returned to horizontal, such as when the unit is installed in a tight space.



#### <NOTE>

- This may result in a slight change in tracking performance.

### 12. SFP connector <SFP+>

This is a connection terminal for an SFP+ optical fiber module. By connecting the SFP+ optical fiber module, SMPTE ST2110\*1 or SDI signals are output as converted optical signals. Select the fiber module that matches the signal bandwidth\*2 for each format.

\*1 A separate optional software key (AW-SFU60) needs to be purchased to enable SMPTE ST2110 functionality.

\*2 • 4K (60p, 59.94p, 50p): 12G

• 4K (other than 60p, 59.94p or 50p): 6G

• HD (60p, 59.94p, 50p): 3G

• HD (other than 60p, 59.94p or 50p): 1.5G

#### <NOTE>

- Optical signal input is not supported on this unit.

### 13. 12G SDI OUT connector <12G SDI OUT>

This is a 12G-SDI video signal output connector.

### 14. HDMI connector <HDMI>

This is the HDMI video output connector.

### 15. USB3.0 HOST connector <USB3.0 HOST>

Video transmission using wireless connections is made possible by connecting a 5G mobile router (one that supports USB tethering)\*3.

\*3 Use a product whose operation is guaranteed. For details, visit the Panasonic website.

#### <NOTE>

- Refer to the catalog of the device you are using for usage times for the 5G mobile router.
- Use a USB cable conforming to the USB3.0 specification. We also recommend using a cable that is 1.5 m (4.9 ft) or shorter.
- Operation is not guaranteed with a cable for USB2.0. This unit will need to be restarted if one is connected by mistake.
- A USB Type A – Type C adaptor may be required, depending on the product to be connected.

### 16. DC IN connector <12V $\overline{\text{IN}}$ > (XLR connector)

Input 12 V DC.

#### <NOTE>

- Use a DC cable with the following lengths.

For 12 V input: Max. 3 m (9.84 ft) (when using an AWG16 cable)

#### External DC power supply

Connect after making sure that the output voltage of the external DC power supply is compatible with the rated voltage of the camera. Select an output amperage for the external DC power supply with a margin above the total amperage of the connected devices. The total amperage of connected devices can be calculated with the following formula.

#### Total power consumption ÷ voltage

When the power of the camera is turned on, inrush current is generated. Insufficient power supply when turning on the power may cause a malfunction. We recommend that you use an external DC power supply that can assure double the capacity of the total power consumption of the camera and connected devices that are turned on by interlock when the power of the camera is turned on (such as lenses, wireless microphone receivers).

- Make sure of the pin alignment of the DC output terminal of the external DC power supply and the camera DC IN connector, and connect the polarity correctly. If the +12 V power supply is mistakenly connected to the GND terminal, it may cause fire or malfunction.

12V $\overline{\text{IN}}$	
1	GND
2	—
3	—
4	+12 V

## Parts and their functions (continued)

### 17. AUDIO IN connector <AUDIO INPUT 1, 2>

Inputs external audio (microphone, line).

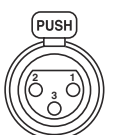
AUDIO INPUT 1, 2		
	1	GND
	2	AUDIO IN (H)
	3	AUDIO IN (C)

### 18. 3G SDI OUT connector <3G SDI OUT 1, 2/PM>

This is an SDI video signal output connector. Depending upon the output signal format, 3G-SDI or 1.5G-SDI signals are output. When using SMPTE ST2110, if images are input to SFP+, then the images input as RETURN signals can be output as from 3G SDI OUT2/PM.

#### <NOTE>

- A separate optional software key (AW-SFU60) needs to be purchased to enable SMPTE ST2110 functionality.

### 19. Ground connector

Connects to the ground connector on a wall outlet, ground bar, etc. for grounding. (→ page 8)

### 20. G/L IN connector <G/L IN>

This is the external sync signal input connector.

This unit supports BBS (Black Burst Sync) and tri-level synchronization.

Supply to this connector the signals that correspond to the video signal format which has been set.

Frequency: 119.88 Hz

Format	External sync signal input format			
	Tri-level sync			BBS
1080/119.88p	—	—	1080/59.94i 1080/29.97PsF	480/59.94i

Frequency: 100 Hz

Format	External sync signal input format			
	Tri-level sync			BBS
1080/100p	—	—	1080/50i 1080/25PsF	576/50i

Frequency: 60 Hz

Format	External sync signal input format			
	Tri-level sync			BBS
2160/60p 1080/60p	1080/60p	—	—	—

Frequency: 59.94 Hz, 29.97 Hz

Format	External sync signal input format			
	Tri-level sync			BBS
2160/59.94p 2160/29.97p 1080/59.94p 1080/29.97p	—	—	1080/59.94i 1080/29.97PsF	480/59.94i
720/59.94p	—	720/59.94p	—	—

Frequency: 50 Hz, 25 Hz

Format	External sync signal input format			
	Tri-level sync			BBS
2160/50p	—	—	1080/50i 1080/25PsF	576/50i
2160/25p				
1080/50p				
1080/25p				
720/50p	—	720/50p	—	—

Frequency: 24 Hz

Format	External sync signal input format			
	Tri-level sync			BBS
2160/24p	1080/24p	1080/24PsF	—	—
1080/24p	—	—	—	—

Frequency: 23.98 Hz

Format	External sync signal input format			
	Tri-level sync			BBS
2160/23.98p	1080/23.98p	1080/23.98PsF	—	—
1080/23.98p	—	—	—	—

### 21. RS-422 connector <RS-422>

This RS-422 connector (RJ-45) is connected when exercising serial control over the unit from an external device. Use a cable with the following specifications for the connection to this connector.

Furthermore, by shorting the R-TALLY signal (2-pin) with the GND (1-pin), it is possible to light the tally lamp (red) in the camera head section of the unit.

#### <NOTE>

- Do not connect PoE cable to the RS-422 port.
- Do not apply a voltage to the R\_TALLY\_IN signal pin.
- Menu settings enable the output to pin 7 and pin 8 of the red tally and green tally signals received by the unit. Output is by contact output, and normally is "OPEN", then it becomes "MAKE" for output. (→ page 49, page 115)
- Control of this unit via the RS-422 connector (serial connection) is not possible from Panasonic controllers (AW-RP150, AW-RP60). To control this unit from Panasonic controllers (AW-RP150, AW-RP60), control via the LAN connector (IP connection).

LAN cable\*1 (category 5e or above, straight cable), max. 1000 m (3280 ft)

\*1 Use of an STP (shielded twisted pair) cable is recommended.



Pin No.	Signal	Pin No.	Signal
1	GND	5	TXD+
2	R_TALLY_IN	6	RXD+
3	RXD-	7	OPTION_OUT1
4	TXD-	8	OPTION_OUT2

## Parts and their functions (continued)

### ■ Example OPTION\_OUT1, OPTION\_OUT2 connector connections

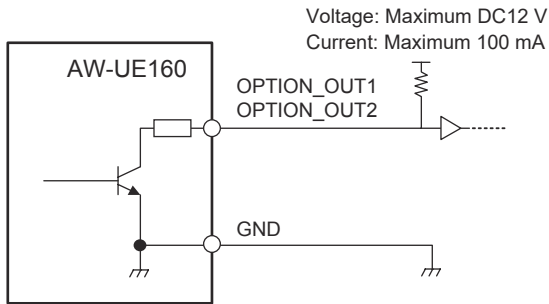

## 22.Tripod screw holes

(Screw: 1/4-20 UNC, ISO 1222 (6.35 mm))

Use these screw holes when securing the unit to a tripod, etc.

Place the tripod on a completely flat and level surface.

Tighten the screws by hand to mount the tripod securely.

Use screw for mounting the tripod that satisfy the following standard.

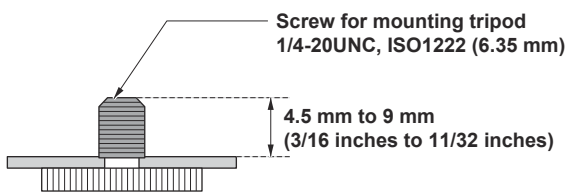

## ■ Output format table

Frequency	System Format	HDMI			12G SDI OUT / SFP+		
60Hz	2160/60p	Crop OFF	Crop(1080)		Crop OFF	Crop(1080)	
		2160/60p 1080/60p	2160/60p 1080/60p		2160/60p 1080/60p	2160/60p 1080/60p	
	1080/60p	1080/60p	1080/60p		1080/60p	1080/60p	
59.94Hz	2160/59.94p	Crop OFF	Crop(1080)	Crop(720)	Crop OFF	Crop(1080)	Crop(720)
		2160/59.94p 1080/59.94p	2160/59.94p 1080/59.94p	2160/59.94p 720/59.94p	2160/59.94p 1080/59.94p	2160/59.94p 1080/59.94p	2160/59.94p 720/59.94p
	2160/29.97p	Crop OFF	Crop(1080)		Crop OFF	Crop(1080)	
		2160/29.97p 1080/29.97p	2160/29.97p 1080/29.97p		2160/29.97p 1080/29.97p	2160/29.97p 1080/29.97p	
	1080/119.88p	1080/119.88p			1080/59.94p*1		
	1080/59.94p	1080/59.94p 1080/59.94i			1080/59.94p 1080/59.94i		
	1080/29.97p	1080/29.97p			1080/29.97p		
720/59.94p	720/59.94p			720/59.94p			
50Hz	2160/50p	Crop OFF	Crop(1080)	Crop(720)	Crop OFF	Crop(1080)	Crop(720)
		2160/50p 1080/50p	2160/50p 1080/50p	2160/50p 720/50p	2160/50p 1080/50p	2160/50p 1080/50p	2160/50p 720/50p
	2160/25p	Crop OFF	Crop(1080)		Crop OFF	Crop(1080)	
		2160/25p 1080/25p	2160/25p 1080/25p		2160/25p 1080/25p	2160/25p 1080/25p	
	1080/100p	1080/100p			1080/50p*1		
	1080/50p	1080/50p 1080/50i			1080/50p 1080/50i		
	1080/25p	1080/25p			1080/25p		
720/50p	720/50p			720/50p			
24Hz	2160/24p	Crop OFF	Crop(1080)		Crop OFF	Crop(1080)	
		2160/24p 1080/24p	2160/24p 1080/24p		2160/24p 1080/24p	2160/24p 1080/24p	
	1080/24p	1080/24p			1080/24p		
23.98Hz	2160/23.98p	Crop OFF	Crop(1080)		Crop OFF	Crop(1080)	
		2160/23.98p 1080/23.98p	2160/23.98p 1080/23.98p		2160/23.98p 1080/23.98p	2160/23.98p 1080/23.98p	
	1080/23.98p	1080/23.98p			1080/23.98p		

\*1 For 119.88p (or 100p), "Frame 1" is output with the frame rate cut to half (59.94p (or 50p)).

## Parts and their functions (continued)

Frequency	System Format	3G SDI OUT1			3G SDI OUT2/PM		
60Hz	2160/60p	Crop OFF	Crop(1080)		Crop OFF	Crop(1080)	
		1080/60p	1080/60p		1080/60p	1080/60p	
	1080/60p	1080/60p		1080/60p	1080/60p		
59.94Hz	2160/59.94p	Crop OFF	Crop(1080)	Crop(720)	Crop OFF	Crop(1080)	Crop(720)
		1080/59.94p 1080/59.94i		720/59.94p	1080/59.94p 1080/59.94i		720/59.94p
	2160/29.97p	Crop OFF	Crop(1080)		Crop OFF	Crop(1080)	
		1080/29.97p		1080/29.97p		1080/29.97p	
	1080/119.88p	1080/59.94p*1		1080/59.94p*2		1080/59.94p*2	
	1080/59.94p	1080/59.94p 1080/59.94i		1080/59.94p 1080/59.94i		1080/59.94p 1080/59.94i	
	1080/29.97p	1080/29.97p		1080/29.97p		1080/29.97p	
720/59.94p	720/59.94p		720/59.94p		720/59.94p		
50Hz	2160/50p	Crop OFF	Crop(1080)	Crop(720)	Crop OFF	Crop(1080)	Crop(720)
		1080/50p 1080/50i		720/50p	1080/50p 1080/50i		720/50p
	2160/25p	Crop OFF	Crop(1080)		Crop OFF	Crop(1080)	
		1080/25p		1080/25p		1080/25p	
	1080/100p	1080/50p*1		1080/50p*2		1080/50p*2	
	1080/50p	1080/50p 1080/50i		1080/50p 1080/50i		1080/50p 1080/50i	
	1080/25p	1080/25p		1080/25p		1080/25p	
720/50p	720/50p		720/50p		720/50p		
24Hz	2160/24p	Crop OFF	Crop(1080)		Crop OFF	Crop(1080)	
		1080/24p		1080/24p		1080/24p	
	1080/24p	1080/24p		1080/24p		1080/24p	
23.98Hz	2160/23.98p	Crop OFF	Crop(1080)		Crop OFF	Crop(1080)	
		1080/23.98p		1080/23.98p		1080/23.98p	
	1080/23.98p	1080/23.98p		1080/23.98p		1080/23.98p	

\*1 For 119.88p (or 100p), "Frame 1" is output with the frame rate cut to half (59.94p (or 50p)).

\*2 For 119.88p (or 100p), "Frame 2" is output with the frame rate cut to half (59.94p (or 50p)).

## Parts and their functions (continued)

Frequency	System Format	ST2110*1			NDI		
60Hz	2160/60p	Crop OFF	Crop(1080)		Crop OFF	Crop(1080)	
		1080/60p	1080/60p		2160/60p 1080/60p	1080/60p	
	1080/60p	1080/60p	1080/60p		1080/60p	1080/60p	
59.94Hz	2160/59.94p	Crop OFF	Crop(1080)	Crop(720)	Crop OFF	Crop(1080)	Crop(720)
		1080/59.94p		720/59.94p	2160/59.94p 1080/59.94p	1080/59.94p	720/59.94p
	2160/29.97p	Crop OFF	Crop(1080)		Crop OFF	Crop(1080)	
		1080/29.97p			2160/29.97p 1080/29.97p	1080/29.97p	
	1080/119.88p	1080/59.94p*2			1080/59.94p*2		
	1080/59.94p	1080/59.94p 1080/59.94i			1080/59.94p		
	1080/29.97p	1080/29.97p			1080/29.97p		
720/59.94p	720/59.94p			720/59.94p			
50Hz	2160/50p	Crop OFF	Crop(1080)	Crop(720)	Crop OFF	Crop(1080)	Crop(720)
		1080/50p		720/50p	2160/50p 1080/50p	1080/50p	720/50p
	2160/25p	Crop OFF	Crop(1080)		Crop OFF	Crop(1080)	
		1080/25p			2160/25p 1080/25p	1080/25p	
	1080/100p	1080/50p*2			1080/50p*2		
	1080/50p	1080/50p 1080/50i			1080/50p		
	1080/25p	1080/25p			1080/25p		
720/50p	720/50p			720/50p			
24Hz	2160/24p	Crop OFF	Crop(1080)		Crop OFF	Crop(1080)	
		1080/24p			2160/24p 1080/24p	1080/24p	
	1080/24p	1080/24p			1080/24p		
23.98Hz	2160/23.98p	Crop OFF	Crop(1080)		Crop OFF	Crop(1080)	
		1080/23.98p			2160/23.98p 1080/23.98p	1080/23.98p	
	1080/23.98p	1080/23.98p			1080/23.98p		

\*1 Output only when the SMPTE ST2110 software key (AW-SFU60) has been activated.

The input format for SMPTE ST2110 is 1080/59.94p, 50p only. Refer to "SMPTE ST2110 specifications" (→ page 30).

\*2 For 119.88p (or 100p), "Frame 1" is output with the frame rate cut to half (59.94p (or 50p)).

## Parts and their functions (continued)

### ■ IP image output 1 (H.265, H.264, etc.)

• When "Streaming mode" is set to "H.265 (UHD)"

Settings		H.265(1)	H.265(2)	H.264(1)	H.264(2)	H.264(3)	JPEG(1)	JPEG(2)	JPEG(3)
Resolution		3840x2160	—	—	—	—	1920x1080 1280x720 640x360	640x360	640x360
Frame rate	System frequency 60Hz/ 59.94Hz	60fps 30fps	—	—	—	—	30fps 15fps 5fps 1fps	30fps 15fps 5fps 1fps	30fps 15fps 5fps 1fps
	System frequency 50Hz	50fps 25fps	—	—	—	—	25fps 12.5fps 5fps 1fps	25fps 12.5fps 5fps 1fps	25fps 12.5fps 5fps 1fps
	System frequency 29.97Hz	30fps	—	—	—	—	30fps 15fps 5fps 1fps	30fps 15fps 5fps 1fps	30fps 15fps 5fps 1fps
	System frequency 25Hz	25fps	—	—	—	—	25fps 12.5fps 5fps 1fps	25fps 12.5fps 5fps 1fps	25fps 12.5fps 5fps 1fps
	System frequency 24/23.98Hz	24fps	—	—	—	—	24fps 12fps 4fps 1fps	24fps 12fps 4fps 1fps	24fps 12fps 4fps 1fps

• When "Streaming mode" is "H.265" (FHD or lower)

Settings		H.265(1)	H.265(2)	H.264(1)	H.264(2)	H.264(3)	JPEG(1)	JPEG(2)	JPEG(3)
Resolution		1920x1080 1280x720	1920x1080 1280x720 640x360	—	—	—	1920x1080 1280x720	640x360	640x360
Frame rate	System frequency 60Hz/ 59.94Hz	60fps 30fps	60fps 30fps	—	—	—	30fps 15fps 5fps 1fps	30fps 15fps 5fps 1fps	30fps 15fps 5fps 1fps
	System frequency 50Hz	50fps 25fps	50fps 25fps	—	—	—	25fps 12.5fps 5fps 1fps	25fps 12.5fps 5fps 1fps	25fps 12.5fps 5fps 1fps
	System frequency 29.97Hz	30fps	30fps	—	—	—	30fps 15fps 5fps 1fps	30fps 15fps 5fps 1fps	30fps 15fps 5fps 1fps
	System frequency 25Hz	25fps	25fps	—	—	—	25fps 12.5fps 5fps 1fps	25fps 12.5fps 5fps 1fps	25fps 12.5fps 5fps 1fps
	System frequency 24/23.98Hz	24fps	24fps	—	—	—	24fps 12fps 4fps 1fps	24fps 12fps 4fps 1fps	24fps 12fps 4fps 1fps



## Parts and their functions (continued)

- When "Streaming mode" is set to "SRT H.265(UHD)"

Settings		H.265(1)	H.265(2)	H.264(1)	H.264(2)	H.264(3)	JPEG(1)	JPEG(2)	JPEG(3)
Resolution		3840x2160	—	—	—	—	1920×1080 1280×720 640×360	640×360	640×360
Frame rate	System frequency 60Hz/ 59.94Hz	60fps 30fps	—	—	—	—	30fps 15fps 5fps 1fps	30fps 15fps 5fps 1fps	30fps 15fps 5fps 1fps
	System frequency 50Hz	50fps 25fps	—	—	—	—	25fps 12.5fps 5fps 1fps	25fps 12.5fps 5fps 1fps	25fps 12.5fps 5fps 1fps
	System frequency 29.97Hz	30fps	—	—	—	—	30fps 15fps 5fps 1fps	30fps 15fps 5fps 1fps	30fps 15fps 5fps 1fps
	System frequency 25Hz	25fps	—	—	—	—	25fps 12.5fps 5fps 1fps	25fps 12.5fps 5fps 1fps	25fps 12.5fps 5fps 1fps
	System frequency 24/23.98Hz	—	—	—	—	—	—	—	—

- When "Streaming mode" is "SRT H.265" (FHD or lower)

Settings		H.265(1)	H.265(2)	H.264(1)	H.264(2)	H.264(3)	JPEG(1)	JPEG(2)	JPEG(3)
Resolution		1920×1080 1280×720	—	—	—	—	1920×1080 1280×720 640×360	640×360	640×360
Frame rate	System frequency 60Hz/ 59.94Hz	60fps 30fps	—	—	—	—	30fps 15fps 5fps 1fps	30fps 15fps 5fps 1fps	30fps 15fps 5fps 1fps
	System frequency 50Hz	50fps 25fps	—	—	—	—	25fps 12.5fps 5fps 1fps	25fps 12.5fps 5fps 1fps	25fps 12.5fps 5fps 1fps
	System frequency 29.97Hz	30fps	—	—	—	—	30fps 15fps 5fps 1fps	30fps 15fps 5fps 1fps	30fps 15fps 5fps 1fps
	System frequency 25Hz	25fps	—	—	—	—	25fps 12.5fps 5fps 1fps	25fps 12.5fps 5fps 1fps	25fps 12.5fps 5fps 1fps
	System frequency 24/23.98Hz	—	—	—	—	—	—	—	—

- You cannot make settings above the resolution and frame rate set by the system format.

## Parts and their functions (continued)

- When "Streaming mode" is set to "H.264(UHD)"

Settings		H.265(1)	H.265(2)	H.264(1)	H.264(2)	H.264(3)	JPEG(1)	JPEG(2)	JPEG(3)
Resolution		—	—	3840×2160	—	—	1920×1080 1280×720 640×360	640×360	640×360
Frame rate	System frequency 60Hz/ 59.94Hz	—	—	60fps 30fps	—	—	30fps 15fps 5fps 1fps	30fps 15fps 5fps 1fps	30fps 15fps 5fps 1fps
	System frequency 50Hz	—	—	50fps 25fps	—	—	25fps 12.5fps 5fps 1fps	25fps 12.5fps 5fps 1fps	25fps 12.5fps 5fps 1fps
	System frequency 29.97Hz	—	—	30fps	—	—	30fps 15fps 5fps 1fps	30fps 15fps 5fps 1fps	30fps 15fps 5fps 1fps
	System frequency 25Hz	—	—	25fps	—	—	25fps 12.5fps 5fps 1fps	25fps 12.5fps 5fps 1fps	25fps 12.5fps 5fps 1fps
	System frequency 24/23.98Hz	—	—	24fps	—	—	24fps 12fps 4fps 1fps	24fps 12fps 4fps 1fps	24fps 12fps 4fps 1fps

- When "Streaming mode" is "H.264" (FHD or lower)

Settings		H.265(1)	H.265(2)	H.264(1)	H.264(2)	H.264(3)	JPEG(1)	JPEG(2)	JPEG(3)
Resolution		—	—	1920×1080 1280×720	1920×1080 1280×720 640×360	1280×720 640×360	1920×1080 1280×720 640×360	640×360	640×360
Frame rate	System frequency 60Hz/ 59.94Hz	—	—	60fps 30fps	60fps 30fps 15fps 5fps	30fps 15fps 5fps	30fps 15fps 5fps 1fps	30fps 15fps 5fps 1fps	30fps 15fps 5fps 1fps
	System frequency 50Hz	—	—	50fps 25fps	50fps 25fps 12.5fps 5fps	25fps 12.5fps 5fps	25fps 12.5fps 5fps 1fps	25fps 12.5fps 5fps 1fps	25fps 12.5fps 5fps 1fps
	System frequency 29.97Hz	—	—	30fps	30fps 15fps 5fps	30fps 15fps 5fps	30fps 15fps 5fps 1fps	30fps 15fps 5fps 1fps	30fps 15fps 5fps 1fps
	System frequency 25Hz	—	—	25fps	25fps 12.5fps 5fps	25fps 12.5fps 5fps	25fps 12.5fps 5fps 1fps	25fps 12.5fps 5fps 1fps	25fps 12.5fps 5fps 1fps
	System frequency 24/23.98Hz	—	—	24fps	24fps	—	24fps 12fps 4fps 1fps	24fps 12fps 4fps 1fps	24fps 12fps 4fps 1fps

## Parts and their functions (continued)

- When "Streaming mode" is set to "SRT H.264(UHD)"

Settings		H.265(1)	H.265(2)	H.264(1)	H.264(2)	H.264(3)	JPEG(1)	JPEG(2)	JPEG(3)
Resolution		—	—	3840×2160	—	—	1920×1080 1280×720 640×360	640×360	640×360
Frame rate	System frequency 60Hz/ 59.94Hz	—	—	60fps 30fps	—	—	30fps 15fps 5fps 1fps	30fps 15fps 5fps 1fps	30fps 15fps 5fps 1fps
	System frequency 50Hz	—	—	50fps 25fps	—	—	25fps 12.5fps 5fps 1fps	25fps 12.5fps 5fps 1fps	25fps 12.5fps 5fps 1fps
	System frequency 29.97Hz	—	—	30fps	—	—	30fps 15fps 5fps 1fps	30fps 15fps 5fps 1fps	30fps 15fps 5fps 1fps
	System frequency 25Hz	—	—	25fps	—	—	25fps 12.5fps 5fps 1fps	25fps 12.5fps 5fps 1fps	25fps 12.5fps 5fps 1fps
	System frequency 24/23.98Hz	—	—	—	—	—	—	—	—

- When "Streaming mode" is "SRT H.264" (FHD or lower)

Settings		H.265(1)	H.265(2)	H.264(1)	H.264(2)	H.264(3)	JPEG(1)	JPEG(2)	JPEG(3)
Resolution		—	—	1920×1080 1280×720	—	—	1920×1080 1280×720 640×360	640×360	640×360
Frame rate	System frequency 60Hz/ 59.94Hz	—	—	60fps 30fps	—	—	30fps 15fps 5fps 1fps	30fps 15fps 5fps 1fps	30fps 15fps 5fps 1fps
	System frequency 50Hz	—	—	50fps 25fps	—	—	25fps 12.5fps 5fps 1fps	25fps 12.5fps 5fps 1fps	25fps 12.5fps 5fps 1fps
	System frequency 29.97Hz	—	—	30fps	—	—	30fps 15fps 5fps 1fps	30fps 15fps 5fps 1fps	30fps 15fps 5fps 1fps
	System frequency 25Hz	—	—	25fps	—	—	25fps 12.5fps 5fps 1fps	25fps 12.5fps 5fps 1fps	25fps 12.5fps 5fps 1fps
	System frequency 24/23.98Hz	—	—	—	—	—	—	—	—

- You cannot make settings above the resolution and frame rate set by the system format.

## Parts and their functions (continued)

• When "Streaming mode" is set to "RTMP(UHD)"

Settings		H.265(1)	H.265(2)	H.264(1)	H.264(2)	H.264(3)	JPEG(1)	JPEG(2)	JPEG(3)
Resolution		—	—	3840×2160	—	—	1920×1080 1280×720 640×360	640×360	640×360
Frame rate	System frequency 60Hz/ 59.94Hz	—	—	60fps 30fps	—	—	30fps 15fps 5fps 1fps	30fps 15fps 5fps 1fps	30fps 15fps 5fps 1fps
	System frequency 50Hz	—	—	50fps 25fps	—	—	25fps 12.5fps 5fps 1fps	25fps 12.5fps 5fps 1fps	25fps 12.5fps 5fps 1fps
	System frequency 29.97Hz	—	—	30fps	—	—	30fps 15fps 5fps 1fps	30fps 15fps 5fps 1fps	30fps 15fps 5fps 1fps
	System frequency 25Hz	—	—	25fps	—	—	25fps 12.5fps 5fps 1fps	25fps 12.5fps 5fps 1fps	25fps 12.5fps 5fps 1fps
	System frequency 24/23.98Hz	—	—	24fps	—	—	24fps 12fps 4fps 1fps	24fps 12fps 4fps 1fps	24fps 12fps 4fps 1fps

• When "Streaming mode" is "RTMP" (FHD or lower)

Settings		H.265(1)	H.265(2)	H.264(1)	H.264(2)	H.264(3)	JPEG(1)	JPEG(2)	JPEG(3)
Resolution		—	—	1920×1080 1280×720	—	—	1920×1080 1280×720 640×360	640×360	640×360
Frame rate	System frequency 60Hz/ 59.94Hz	—	—	60fps 30fps	—	—	30fps 15fps 5fps 1fps	30fps 15fps 5fps 1fps	30fps 15fps 5fps 1fps
	System frequency 50Hz	—	—	50fps 25fps	—	—	25fps 12.5fps 5fps 1fps	25fps 12.5fps 5fps 1fps	25fps 12.5fps 5fps 1fps
	System frequency 29.97Hz	—	—	30fps	—	—	30fps 15fps 5fps 1fps	30fps 15fps 5fps 1fps	30fps 15fps 5fps 1fps
	System frequency 25Hz	—	—	25fps	—	—	25fps 12.5fps 5fps 1fps	25fps 12.5fps 5fps 1fps	25fps 12.5fps 5fps 1fps
	System frequency 24/23.98Hz	—	—	24fps	—	—	24fps 12fps 4fps 1fps	24fps 12fps 4fps 1fps	24fps 12fps 4fps 1fps

## Parts and their functions (continued)

- When “Streaming mode” is set to “JPEG”

Settings		H.265(1)	H.265(2)	H.264(1)	H.264(2)	H.264(3)	JPEG(1)	JPEG(2)	JPEG(3)
Resolution		—	—	1920×1080 1280×720	1920×1080 1280×720 640×360	1280×720 640×360	3840×2160	—	—
Frame rate	System frequency 60Hz/ 59.94Hz	—	—	60fps 30fps	60fps 30fps 15fps 5fps	30fps 15fps 5fps	5fps 1fps	—	—
	System frequency 50Hz	—	—	50fps 25fps	50fps 25fps 12.5fps 5fps	25fps 12.5fps 5fps	5fps 1fps	—	—
	System frequency 29.97Hz	—	—	30fps	30fps 15fps 5fps	30fps 15fps 5fps	5fps 1fps	—	—
	System frequency 25Hz	—	—	25fps	25fps 12.5fps 5fps	25fps 12.5fps 5fps	5fps 1fps	—	—
	System frequency 24/23.98Hz	—	—	24fps	24fps	—	4fps 1fps	—	—

- When “Streaming mode” is set to “NDI|HX”

Settings		NDI HX	JPEG(1)
Resolution		1920×1080 1280×720	1280×720 640×360
Frame rate	System frequency 60Hz/ 59.94Hz	60fps 30fps	30fps 15fps 5fps 1fps
	System frequency 50Hz	50fps 25fps	25fps 12.5fps 5fps 1fps
	System frequency 29.97Hz	30fps	30fps 15fps 5fps 1fps
	System frequency 25Hz	25fps	25fps 12.5fps 5fps 1fps

## Parts and their functions (continued)

- When “Streaming mode” is set to “High Bandwidth NDI”

Settings		High Bandwidth NDI	JPEG(1)
Resolution		—	1920×1080 1280×720 640×360
Frame rate	System frequency 60Hz/ 59.94Hz	—	30fps 15fps 5fps 1fps
	System frequency 50Hz	—	25fps 12.5fps 5fps 1fps
	System frequency 29.97Hz	—	30fps 15fps 5fps 1fps
	System frequency 25Hz	—	25fps 12.5fps 5fps 1fps
	System frequency 24/23.98Hz	—	24fps 12fps 4fps 1fps

### ■ SMPTE ST2110 specifications

Point	Sub-point	Specifications
Supported standards	SMPTE ST2110	SMPTE ST2110-10/-20/-21/-30
	PTP	SMPTE ST2059-2
	NMOS	IS-04/IS-05
Number of outputs (TX)	Image	3
	Audio	2
	Supplementary data	—
Number of inputs (RX)	Image	1
	Audio	—
	Supplementary data	—
Output specifications	Image formats (MAIN)	1080/60p, 1080/59.94p, 50p, 1080/59.94i, 50i, 1080/29.97p*1, 25p*1, 1080/24p, 1080/23.98p*1, 720/59.94p, 50p
	Image formats (CROP)	1080/60p, 1080/59.94p, 50p, 1080/59.94i, 50i, 1080/29.97p*1, 25p*1, 1080/24p, 1080/23.98p*1, 720/59.94p, 50p
	Image formats (MONITOR)	1080/60p, 1080/59.94p, 50p, 1080/59.94i, 50i, 1080/29.97p*1, 25p*1, 1080/24p, 1080/23.98p*1, 720/59.94p, 50p
	Audio specifications MIC1/2	PCM/48 kHz/24bit/1ch x2
Input specifications	Image formats (RETURN)	1080/59.94p, 1080/50p
	Audio specifications MIC1/2	—

\*1 Native output

#### <NOTE>

- A separate optional software key (AW-SFU60) needs to be purchased to enable SMPTE ST2110 functionality. Use EasyIP Setup Tool Plus to activate AW-SFU60. Refer to the operating instructions available on the EasyIP Setup Tool Plus download page for activation instructions.

**Wireless remote control: AW-RM50AG (optional accessory)**

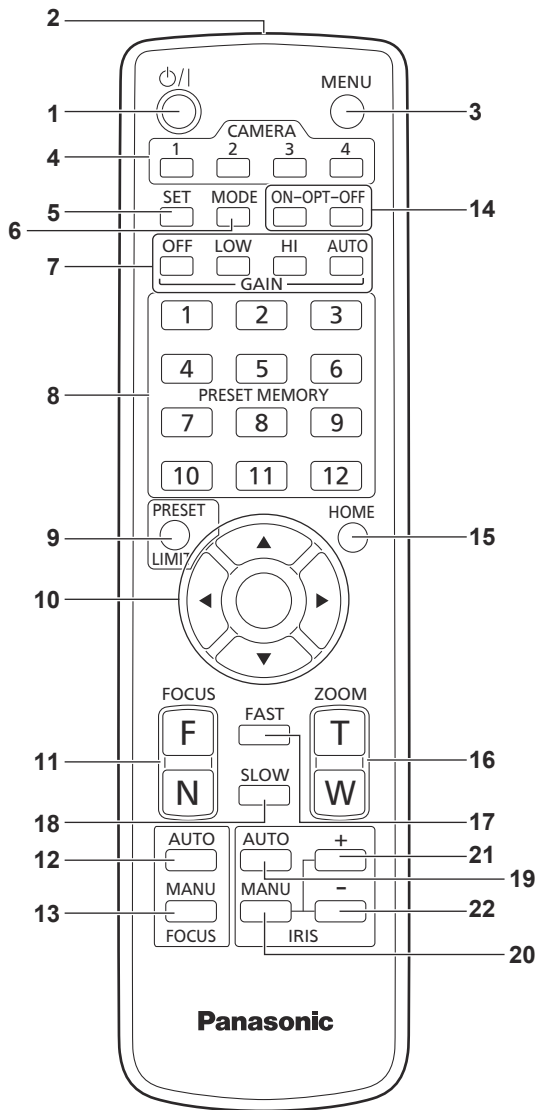

**1. ON/STANDBY button <⏻/>**

Each time this is pressed for 2 seconds, operation switches between turning on the unit's power and establishing the standby status.

**2. Signal transmission window**

**3. MENU button <MENU>**

Each time this is pressed for 2 seconds, operation switches between displaying the unit's camera menu and exiting the camera menu. When it is pressed quickly (for less than 2 seconds) while a camera menu is displayed, the setting change is canceled. Furthermore, the pan and tilt movement range limits (limiters) are set and released by operating the <MENU> button, <PRESET/LIMIT> button and the pan/tilt buttons (<▲> <▼> <◀> <▶>). For details, refer to "Setting/releasing the limiters" (→ page 195).

**4. CAMERA buttons <1> to <4>**

Selects a camera to be operated. Once a button has been selected, the unit corresponding to the selected button can be operated.

**5. SET button <SET>**

If this button is held down for 2 seconds when the [AWB A] memory or [AWB B] memory has been selected for the white balance adjustment, the black balance is adjusted automatically and registered in the memory selected. When this button is pressed for under 2 seconds, only the white balance is adjusted automatically.

**6. MODE button <MODE>**

This is used to select the video signals which are output from the unit. Each time it is pressed, the signals are switched between the color bar signals and camera video signals.

**<NOTE>**

- When [Audio] is set to [On] and the color bar is displayed, a test sound (1 kHz) is output. Be cautious of the volume on external devices.

**7. GAIN button <OFF> <LOW> <HI> <AUTO>**

These are used to set the gain.

The gain increase can be set in three steps using the <OFF>, <LOW> and <HI> buttons.

<LOW> is set to 6 dB, and <HI> is set to 12 dB.

When the <AUTO> button is pressed, the AGC function is activated, and the gain is adjusted automatically depending on the light quantity. The maximum gain of the AGC function can be set using the camera menu.

**8. PRESET MEMORY buttons <1> to <12>**

These are used to call the information on the unit's directions and other settings, which have been registered in the unit's preset memories No.1 to No.12, and reproduce those settings.

Settings in preset memories No.13 and above cannot be called from the wireless remote control.

**9. PRESET/LIMIT button <PRESET/LIMIT>**

This is used to register the settings in the preset memories or set or release the limiters.

When a PRESET MEMORY button is pressed while the <PRESET/LIMIT> button is held down, the information on the unit's current direction and other settings is registered in the call button.

PRESET MEMORY buttons <1> to <12> correspond to the unit's No.1 to No.12 preset memories.

Furthermore, the pan and tilt movement range limits (limiters) are set and released by operating the <PRESET/LIMIT> button, <MENU> button and the pan/tilt buttons (<▲> <▼> <◀> <▶>).

For details, refer to "Setting/releasing the limiters" (→ page 195).

**10. Pan-tilt buttons and menu operation buttons**

<▲> <▼> <◀> <▶> <○>

1) These are used to change the unit's direction.

The unit is tilted in the up/down direction using the <▲> and <▼> buttons and panned in the left/right direction using the <◀> and <▶> buttons.

The <○> button does not work during tilting and panning.

When the <▲> or <▼> and <◀> or <▶> buttons are pressed at the same time, the unit moves diagonally.

2) The buttons are used for menu operations when the unit displays the camera menus.

Use the <▲>, <▼> (<◀>, <▶>) buttons to select the menu items.

When a selected item has a sub-menu, the sub-menu will be displayed by pressing the <○> button.

When the cursor is aligned with a particular item and the <○> button is pressed on the setting menu at the bottom hierarchical level, the setting of the selected item blinks.

When the <○> button is pressed after the setting has been changed using the <▲> and <▼> (<◀> and <▶>) buttons, the setting stops blinking, and the new setting is entered.

A setting for a regular menu item is reflected immediately if it is changed while it is still flashing.

If the <MENU> button is pressed quickly (for less than 2 seconds) while the setting is in the blinking status, the change will be canceled, and the setting selected prior to the change will be restored.

**<NOTE>**

- To prevent malfunctioning, there are a number of menu items ([SCENE], [FORMAT] and [FREQUENCY]) whose setting is not reflected immediately even if it is changed while it is still flashing. It is reflected only after the <○> button has been pressed, causing the setting to stop flashing and the new setting to be entered.
- A confirmation screen appears before the settings of some menu items are to be entered.

## Parts and their functions (continued)

### 11.FOCUS button <F> <N>

These are used to adjust the lens focus manually when the manual setting is established for the lens focus.

The focus is adjusted in the far using the <F> button and in the near using the <N> button.

### 12.FOCUS AUTO button <FOCUS AUTO>

This is used when automatically adjusting the lens focus.

### 13.FOCUS MANU button <FOCUS MANU>

This is used when manually adjusting the lens focus.

The FOCUS buttons (<F> and <N>) are used when performing the actual adjustment.

### 14.OPT button <ON> <OFF>

Turn night mode on/off.

#### <NOTE>

- In night mode, video output will be in black and white. In addition, the iris will be forcibly opened.
- White balance adjustment is not possible in night mode.
- ND filter switching is not possible in night mode.

### 15.HOME button <HOME>

When this is pressed for 2 seconds, the unit's direction (panning or tilting) returns to the reference position.

### 16.ZOOM button <T> <W>

These are used to adjust the lens zoom.

The zoom is adjusted in the wide-angle using the <W> button and in the telephoto using the <T> button.

### 17.FAST button <FAST>

This is used to change the movement speed at which the panning, tilting, zooming and focusing operations are performed to the high speed.

When the button is tapped, the movement speed can be set to the normal high-speed operation. When the button is held down, it can be set to an even faster high-speed operation. Tap the button to return the movement speed to the normal high-speed operation.

#### <NOTE>

- The operating speed for panning and tilting when the preset memory settings have been called can be changed using the "PRESET SPEED" item of the camera menu.

### 18.SLOW button <SLOW>

This is used to change the movement speed at which the panning, tilting, zooming and focusing operations are performed to the low speed.

When the button is tapped, the movement speed can be set to the normal low-speed operation. When the button is held down, it can be set to an even slower low-speed operation. Tap the button to return the movement speed to the normal low-speed operation.

### 19.IRIS AUTO button <IRIS AUTO>

This establishes the setting for adjusting the lens iris automatically in line with the light quantity.

### 20.IRIS MANU button <IRIS MANU>

This establishes the setting for adjusting the lens iris manually.

The <IRIS +> and <IRIS -> buttons are used when performing the actual adjustment.

### 21.IRIS + button <IRIS +>

This is used to adjust the lens iris in the opening direction.

### 22.IRIS - button <IRIS ->

This is used to adjust the lens iris in the closing direction.

## Setting the remote control IDs

The wireless remote control (optional accessory) is capable of operating up to four units.

IDs are used to set which units are selected when the CAMERA <1> to <4> buttons on the wireless remote control have been pressed.

- When operating a multiple number of these units using wireless remote controls, set a different remote control ID for each control.
- When using one unit, set the remote control ID to "CAM1" unless the setting needs to be changed.

### ■ Setting procedure

Set [CAM1] to [CAM4] in [MAINTENANCE] – [WIRELESS CONTROL] – [WIRELESS ID] from the OSD menu of this unit.

### WIRELESS ID [CAM1, CAM2, CAM3, CAM4]

Set the remote control ID (CAM1 to CAM4).

The [CAM1] to [CAM4] in this setting correspond to the CAMERA <1> to <4> buttons on the wireless remote control.

(The factory setting is "CAM1".)

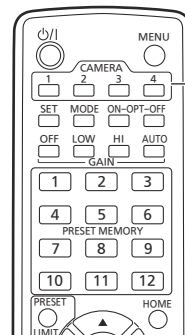

CAMERA <1> to <4> buttons



## Network settings

---

### Using EasyIP Setup Tool Plus to make settings for the unit

You can use EasyIP Setup Tool Plus to make network related settings for this unit, display the camera images, and update the firmware.

The app determines PTZ cameras for which updates are available and does the necessary operations from downloading the firmware to updating the version.

EasyIP Setup Tool Plus can be obtained by downloading from the following website.

<https://pro-av.panasonic.net/en/>

Refer to the Help page for EasyIP Setup Tool Plus for details.

### Setting the initial account

#### 1. Set the initial account.

In the initial state, the initial account setting screen is displayed when the web screen is displayed.

Set a user name and password. (→ page 101)



#### <NOTE>

- Do not set character strings that can be easily guessed by third parties.
- Change the password at regular intervals.
- The password must use at least 3 of the following 4 character types and be 8 characters or longer.
  - Alphabet upper cases
  - Alphabet lower cases
  - Numerals
  - Symbols (! \$ % & ' ( ) \* + , - . / ? @ [ ] ^ \_ ` ~ )
- When a password is set that does not adhere to the above policy, take responsibility for use of the device with due consideration for the security risks in the installation environment, etc.
- A warning is displayed if the set password goes against the recommended setting policy. When changing the password, click the [Back] button and set the password again.

When continuing with the setting with full understanding of the security risks, click [Continue] to complete the setting.
- If you forget the account information that was set, use the switches for initialization of service switches to reset the user information used for connecting to the network. (→ page 19)

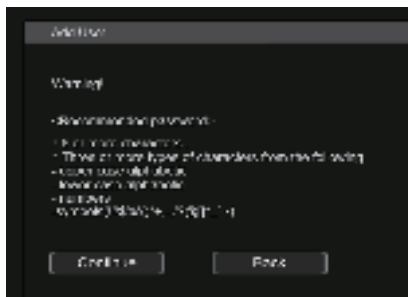

#### 2. Completing registration of the initial account

After completing registration of the initial account, the following registration completed screen is displayed.

The live screen [Live] is automatically displayed after about 10 seconds elapse after the completed screen is displayed.

If the live screen [Live] is not displayed after 10 seconds elapse, manually move to the live screen [Live] by clicking the "please click here" link.

This completes the process of registering the initial account.

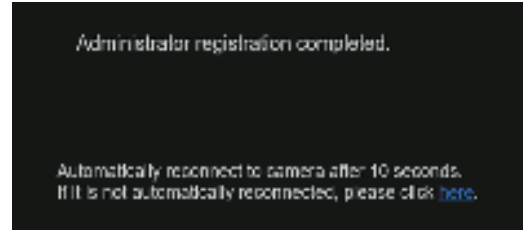

#### <NOTE>

- Network connection with AW-RP150 or AW-RP60 requires setup of an initial account.

When an initial account is not set up, AW-RP150 or AW-RP60 can detect but cannot control this unit.

### Installing the plug-in viewer software

To view IP images from the unit on Microsoft Edge (IE mode), the "Network Camera View 4S" plug-in viewer software (ActiveX®) must be installed.

The plug-in viewer software can be installed directly from the unit.



#### <NOTE>

- [Automatic installation of viewer software] is set to [On] at the time of purchase, allowing you to install directly from the unit. If a message appears in the web browser's information bar, see page 204.
- When you display the Live screen [Live] on the personal computer for the first time, the installation screen for the plug-in viewer software (ActiveX) appears. Follow the instructions on the screen to perform installation. (Only when using the Microsoft Edge (IE) mode)
- If the plug-in viewer software (ActiveX) installation screen continues to appear when switching screens, even after it is installed, restart the personal computer.
- A license is required for the plug-in viewer software for each personal computer on which it is installed. You can view the number of times the plug-in viewer software was automatically installed in the product information screen [Product info.] (→ page 188). For details on licenses, consult your local dealer.
- To uninstall the plug-in viewer software, select [Control Panel] - [Programs] - [Uninstall a program] in Windows, and remove "Network Camera View 4S".

# Basic shooting operations

---

**1. Set the subject brightness to the appropriate level.**

**2. Turn on the power of all the units and devices in the system.**

**3. Select the unit to be operated.**

Even when using only one unit, it must still be selected from the wireless remote control or controller.

**4. Select the shooting mode.**

One of eight shooting modes (Scene1, Scene2, Scene3, Scene4, Scene5, Scene6, Scene7 or Scene8) — whichever one will best suit the shooting conditions — can be selected.

The shooting modes are set by the user.

For details of the factory settings, refer to pages 84 to 100.

Select the mode that satisfies the shooting conditions and suits your preferences.

When continuing to shoot in the same circumstances, there is no need to select another mode.

**5. Start shooting.**

**(After shooting, turn off the power of all the units and devices in the system.)**

**<NOTE>**

- Some of the initial settings are auto settings and cannot be operated manually. To operate them manually, switch from the auto settings to the manual settings as required.

If the settings have already been changed and the original settings are to be restored, refer to the “What to do when encountering problems in the basic shooting operations” (→ page 40).

# How to turn the power on and off

## Turning the power on

### When performing operations from a wireless remote control

#### 1. Set all the power switches of the units and devices connected in the system to ON.

- This unit does not have a power switch.

When power is supplied to it, the status display lamp will light orange, and the unit is set to the Standby mode.

#### <NOTE>

- Under factory default conditions, the unit will be in Power ON mode when power is supplied for the first time. (Status display lamp: Lit green)
- When the power supply is cut off while the unit is in Standby mode, the unit will be in Standby mode the next time power is supplied. (Status display lamp: Lit orange)
- When the power supply is cut off while the unit is in Power ON mode, the unit will be in Power ON mode the next time power is supplied. (Status display lamp: Lit green)

#### 2. Press one of the CAMERA <1> to <4> buttons on the wireless remote control to select the unit.

#### 3. Press the <⏻/|> button on the wireless remote control for about 2 seconds.

The Power ON mode is established, images are output, and control can be exercised.

- The unit's status display lamp now lights up green.

#### <NOTE>

- It takes maximum 30 seconds per unit for the initial settings operation to be completed. During this period, the unit cannot be operated. (Status display lamp: Lit orange)

#### 4. If a multiple number of units are going to be used, repeat steps 2 and 3 as required.

The unit's status display lamp blinks green when a signal matched by the remote control ID has been received, and it blinks orange when a signal that is not matched by the remote control ID has been received.

#### <NOTE>

- When operation is transferred to the Standby mode:  
The current zoom, focus and iris positions are stored in the memory (Power ON preset).
- When operation is transferred to the Power ON mode:  
The zoom, focus and iris are adjusted to the positions which were stored in the memory (Power ON preset) when operation was transferred to the Standby mode.

## When performing operations from a controller

### When using an AW-RP150 or AW-RP60

For details, refer to the operating instructions for the controller.

### When using a commercially available controller

For details, refer to the operating instructions for the controller.

## Turning the power off

### When performing operations from a wireless remote control

#### 1. Press one of the CAMERA <1> to <4> buttons on the wireless remote control to select the unit.

#### 2. Press the <⏻/|> button on the wireless remote control for about 2 seconds.

The unit enters Standby mode.

- The unit's status display lamp now lights up orange.

#### 3. If a multiple number of units are going to be used, repeat steps 1 and 2 as required.

#### 4. Set all the power switches of the units and devices connected in the system to OFF.

- This unit does not have a power switch.

#### <NOTE>

- When operation is transferred to the Standby mode:  
The current zoom, focus and iris positions are stored in the memory (Power ON preset).
- When operation is transferred to the Power ON mode:  
The zoom, focus and iris are adjusted to the positions which were stored in the memory (Power ON preset) when operation was transferred to the Standby mode.

## When performing operations from a controller

### When using an AW-RP150 or AW-RP60

For details, refer to the operating instructions for the controller.

### When using a commercially available controller

For details, refer to the operating instructions for the controller.

## Selecting the units

---

Select the unit (or units) to be operated from the wireless remote control or controller.

Even when using only one unit, it must still be selected.

Set in [WIRELESS ID] from the OSD menu of this unit.(→ page 32)

### When performing operations from a wireless remote control

---

Up to four units can be operated using one wireless remote control.

#### 1. Press the CAMERA<1>, <2>, <3>, or <4> button.

The unit's status display lamp blinks green when a signal matched by the remote control ID has been received, and it blinks orange when a signal that is not matched by the remote control ID has been received.

### When performing operations from a controller

---

#### When using an AW-RP150 or AW-RP60

For details, refer to the operating instructions for the controller.

- Network connection with AW-RP150 or AW-RP60 requires setup of an initial account. (→ page 34)

When an initial account is not set up, AW-RP150 or AW-RP60 can detect but cannot control this unit.

- When operating the camera on a network with a controller, such as the AW-RP150 or AW-RP60, and [SERIAL] or [IP] of [TRACKING DATA OUTPUT] is set to [ON], the tracking data output may be delayed or the value may not be updated. (→ page 71)

# Shooting

## When performing operations from a wireless remote control

### ■ Changing the camera's direction

#### Moving the camera toward the left or right (panning):

Press the <◀> or <▶> button.

#### Moving the camera up or down (tilting):

Press the <▲> or <▼> button.

#### Moving the camera diagonally:

Press the <▲> or <▼> button and <◀> or <▶> button at the same time.

#### Returning the camera to the reference position:

Press the <HOME> button for about 2 seconds.

### ■ Using the zoom function

#### Zooming in (the subject becomes magnified in size):

Press the <T> button of <ZOOM>.

#### Zooming out (the subject becomes reduced in size):

Press the <W> button of <ZOOM>.

### ■ Switching the panning/tilting and lens operation speed

#### Changing the direction or zoom at high speed:

Press the <FAST> button.

When this button is held down, the speed can be set to an even higher speed.

When it is tapped, the normal speed (high speed) is restored.

#### Changing the direction or zoom at low speed:

Press the <SLOW> button.

When this button is held down, the speed can be set to an even lower speed.

When it is tapped, the normal speed (low speed) is restored.

The speeds at which the pan, tilt, zoom, focus and iris are controlled are now switched.

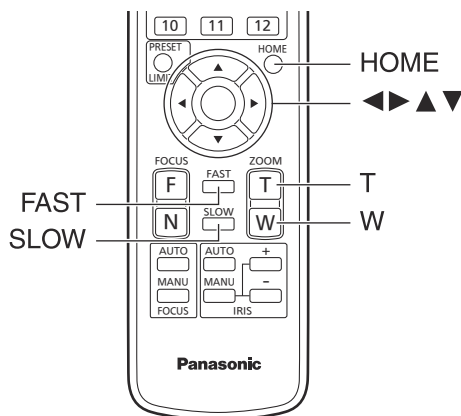

## When performing operations from a controller

### ■ Changing the camera's direction

#### Moving the camera toward the left or right (panning):

Tilt the <PAN/TILT> lever toward L or R.

#### Moving the camera up or down (tilting):

Tilt the <PAN/TILT> lever toward UP or DOWN.

#### Moving the camera diagonally:

Tilt the <PAN/TILT> lever diagonally.

### ■ Using the zoom function

#### Zooming in (the subject becomes magnified in size):

Tilt the <ZOOM> lever toward the TELE direction.

#### Zooming out (the subject becomes reduced in size):

Tilt the <ZOOM> lever toward the WIDE direction.

### ■ Switching the panning/tilting and lens operation speed

#### When using an AW-RP150 or AW-RP60

For details, refer to the operating instructions for the controller.

# What to do when encountering problems in the basic shooting operations

---

If the trouble is not resolved by taking the action suggested below, refer to "Troubleshooting" (→ page 197).

## When performing operations from a wireless remote control

---

### The unit does not move.

- Press the CAMERA<1>, <2>, <3>, or <4> button to select the unit which is to be operated.  
If only one unit is being used, it is normally selected using the CAMERA<1> button.
- If the unit's status display lamp is off or lights up orange, it means that the unit's power is not on.  
Refer to "Turning the power on" (→ page 37), and turn on the power.
- If the unit's status display lamp does not blink even when the wireless remote control is operated near the unit's wireless remote control signal light-sensing area, it means that the wireless remote control's batteries have run down.  
Replace the batteries.

### Multiple color bands (color bars) are displayed.

Switch to the camera image by pressing the <MODE> button.

### The menu screen is displayed.

Press the <MENU> button for 2 seconds to exit the camera menu.

### The lens focus is not adjusted automatically.

Press the <FOCUS AUTO> button to switch to auto focusing.

### The camera picture is too light or too dark.

- Press the <IRIS AUTO> button to switch the lens iris adjustment to auto.
- Press the <AUTO> button of <GAIN> to switch the gain adjustment to auto.

### Something is wrong with the coloring of the camera pictures.

Refer to "Auto tracking white adjustment (ATW)" (→ page 45), and switch to [ATW].

### The camera menus are not displayed.

Restart the camera and open any of the camera menus within about a minute, the menus will be displayed in all the outputs.

## When performing operations from a controller

---

### The unit does not move.

- Select the unit to be operated by following the procedure below.  
**When using an AW-RP150 or AW-RP60**  
For details, refer to the operating instructions for the controller.
- If the unit's status display lamp is off or lights up orange, it means that the unit's power is not on.  
Refer to "Turning the power on" (→ page 37), and turn on the power.
- Check that the account settings for this unit have been set correctly. (→ page 102)
- Network connection with AW-RP150 or AW-RP60 requires setup of an initial account. (→ page 34)  
When an initial account is not set up, AW-RP150 or AW-RP60 can detect but cannot control this unit.
- When using a Panasonic controller (AW-RP150, AW-RP60), set [Wait time mode] to [Mode2] when using digest authentication. (→ page 167)  
Smooth operation may be diminished when [Wait time mode] is set to [Mode1].

### Multiple color bands (color bars) are displayed.

Switch to the camera image by pressing the <BARS> button.

### The lens focus is not adjusted automatically.

Press the <AUTO> button of <FOCUS> to switch to auto focusing.

### The camera picture is too light or too dark.

- Press the <AUTO> button of <IRIS> to switch the lens iris adjustment to auto.
- Press the <AUTO> button of <GAIN> to switch the gain adjustment to auto.

### Something is wrong with the coloring of the camera pictures.

Refer to "Auto tracking white adjustment (ATW)" (→ page 45), and switch to [ATW].

### The camera menus are not displayed.

Restart the camera and open any of the camera menus within about a minute, the menus will be displayed in all the outputs.



## More advanced operations

---

### Manual shooting (→ page 42)

- Manually adjusting the focus
- Manually adjusting the iris
- Manually adjusting the shutter speed
- Manually adjusting the gain

### Preset memories (→ page 43)

- Up to 100 settings for the camera direction (panning and tilting), zoom, focus, iris, gain up and white balance can be registered in the preset memories, and called.
- The number of settings that can be registered and called depends on the type of wireless remote control (12 settings) or controller that is used for operation.

### White balance adjustment (→ pages 44 to 45)

- This adjustment is performed to express the white accurately. Its setting also has an effect on the color tones of the entire screen.
- It must be performed when using the unit for the first time or when the unit has not been used for a prolonged period.
- Perform adjustment when the lighting conditions or brightness changes.
- Once the white balance has been attained, no further adjustment is required provided that the unit is going to be used under the same conditions.
- White balance adjustment is not possible in night mode.

### Black balance adjustment (→ page 46)

- This adjustment is performed to express the black accurately. Its setting also has an effect on the color tones of the entire screen.
- It must be performed when using the unit for the first time or when the unit has not been used for a prolonged period.
- It must be performed when the ambient temperature has changed significantly and at the change of the seasons.
- Once the black balance has been attained, no further adjustment is required provided that the unit is going to be used under the same conditions.

### Black level (master pedestal) adjustment (→ page 46)

- This adjustment is performed to align the black level (pedestal level) of a multiple number of cameras.

### Genlock adjustment (→ page 47)

- This adjustment is performed to achieve phase alignment by applying external synchronization (genlock) when a multiple number of cameras will be used or when the unit will be used in combination with other devices.

# Manual shooting

## Manually adjusting the focus

The lens focus can be adjusted manually.

### When performing operations from a wireless remote control

1. Press the <FOCUS MANU> button to switch the focus to manual adjustment.
2. Press the <F> or <N> button of <FOCUS> to adjust the focus.  
When the <F> button is pressed, the focus moves further away (far); conversely, when the <N> button is pressed, it moves nearer (near). The speed of focusing and other adjustments can be switched to fast or slow by pressing the <FAST> or <SLOW> button, respectively.
3. If necessary, press the <FOCUS AUTO> button to return the focus to the automatic adjustment.

### When performing operations from a controller

#### When using an AW-RP150 or AW-RP60

For details, refer to the operating instructions for the controller.

#### <NOTE>

- When the focus is set to manual, the subject may go out of focus during panning, tilting and zooming. Therefore, the unit comes with a function which compensates for this. (FOCUS ADJUST WITH PTZ.) If the function has been set to [OFF], either adjust the focus, as required, after zooming or set the focus to auto.  
(→ page 75, page 118)
- When switching between focus modes (Manual/Auto), and [SERIAL] or [IP] of [TRACKING DATA OUTPUT] is set to [ON], the tracking data output may be delayed or the value may not be updated.  
(→ page 71)

## Manually adjusting the iris

The lens iris can be adjusted manually.

### When performing operations from a wireless remote control

1. Press the <IRIS MANU> button to switch the iris to manual adjustment.
2. Press the <IRIS +> or <IRIS -> button to adjust the iris.  
Press the <IRIS +> button to adjust the lens iris in the opening direction; conversely, press the <IRIS -> button to adjust the lens iris in the closing direction.  
The speed of the iris and other adjustments can be switched to fast or slow by pressing the <FAST> or <SLOW> button, respectively.
3. If necessary, press the <IRIS AUTO> button to return the iris to the automatic adjustment.

### When performing operations from a controller

#### When using an AW-RP150 or AW-RP60

For details, refer to the operating instructions for the controller.

#### <NOTE>

- In the night mode, the iris is set to open as a measure to prevent video spying.  
Adjust the brightness at the light source.
- When switching between iris modes (Manual/Auto), and [SERIAL] or [IP] of [TRACKING DATA OUTPUT] is set to [ON], the tracking data output may be delayed or the value may not be updated.  
(→ page 71)

## Manually adjusting the shutter speed

The shutter speed can be set using two methods. One is a method that specifies the time (where a time such as 1/250 sec. is designated), and the other is a method that specifies the frequency (where synchro scan, 60.2 Hz, etc. is designated).

When shooting a TV screen or personal computer's monitor screen, the horizontal noise generated when the screen is shot can be minimized by adjusting the frequency to the screen frequency using synchro scan.

### When performing operations from a wireless remote control

Perform the adjustments on the Camera menu.

For details, refer to the [PAINT] – [SHUTTER SPEED] (→ page 60).

### When performing operations from a controller

#### When using an AW-RP150 or AW-RP60

For details, refer to the operating instructions for the controller.

## Manually adjusting the gain

There are two ways to adjust the gain. One way involves using the buttons on the wireless remote control or controller; the other way involves using the Camera menu or Web setup screen [Setup]. The gain can be adjusted more precisely using the Camera menu or Web setup screen [Setup].

For details, refer to the [PAINT] – [GAIN SETTING] (→ page 58).

#### <NOTE>

- When adjusting the gain, the light quantity may change suddenly (causing the image output to be subjected to a shock).

### When performing operations from a wireless remote control

1. Press one of the <GAIN> buttons (<OFF>, <LOW> or <HI>).  
These buttons enable the gain increase to be selected in three steps. The <LOW> button is used to select 6 dB; the <HI> button is used to select 12 dB.
2. If necessary, press the <AUTO> button of <GAIN> in order to return the gain to the automatic adjustment (AGC).

### When performing operations from a controller

#### When using an AW-RP150 or AW-RP60

For details, refer to the operating instructions for the controller.

In any case, the maximum gain of the automatic adjustment (AGC) can be set by the camera menu or Web setup screen [Setup].

For details, refer to the [PAINT] – [GAIN SETTING] – [AGC MAX GAIN] (→ page 58).

## Preset memories

---

This unit enables up to 100 settings for the camera direction (panning and tilting), zoom, focus, iris, gain and white balance to be registered in its preset memories, and called.

However, the number of settings that can be registered and called depends on the type of wireless remote control or controller that is used for operation.

- The focus and iris operating modes (manual and auto settings) are neither registered nor recalled. The current focus and iris values are registered.
- The focus and iris values can be recalled only when the manual settings are applicable.
- For the white balance, the current WHITE BALANCE MODE adjustment values are registered. If a preset value is recalled when AWB A or AWB B is selected, the adjustment value selected when it was registered as a preset will be recalled.

### <NOTE>

- When there is a large difference in the environmental temperature between the time of registration and the time the setting is called, displacement of the preset position may occur.
- If displacement occurs, perform registration again.
- When a manual operation is performed for pan, tilt, zoom, focus or iris during preset recall, the preset operation for the pan, tilt, zoom, focus or iris operation concerned will be aborted.
- If another preset has been recalled during an ongoing preset recall, the preset being recalled is aborted, and operation for the preset called last is performed instead.
- When recalling the preset memory during an ongoing preset memory recall (the first preset memory recall is aborted and performing the subsequent preset memory recall), and [SERIAL] or [IP] of [TRACKING DATA OUTPUT] is set to [ON], the tracking data output may be delayed or the value may not be updated. (→ page 71)

## When performing operations from a wireless remote control

---

Twelve settings (preset No.1 to No.12) can be registered and called using the wireless remote control.

The <1> to <12> buttons correspond to the unit's preset memories No.1 to No.12.

### ■ Registering the settings in the preset memories

#### 1. Display the picture to be shot on the monitor.

Operate the pan, tilt or zoom buttons to determine the camera angle. Adjust the focus, iris, gain and white balance if they need to be adjusted.

#### 2. While holding down the <PRESET> button, press the button corresponding to the preset memory number.

- If a preset memory number with an already registered setting has been selected, the existing setting will be erased and replaced with the new one.

### ■ Calling the settings of the preset memories

#### 1. Press the button in which the preset memory setting has been registered.

## When performing operations from a controller

---

### When using an AW-RP150 or AW-RP60

Up to 100 entries can be registered/recalled.

For details, refer to the operating instructions for the controller.

# White balance adjustment

Adjust the ratio between the three primary colors (RGB) to reproduce white accurately. If the white balance is out of adjustment, not only will white be reproduced poorly, but the color tones of the screen as a whole will also be degraded.

- Perform adjustment when using the unit for the first time or when the unit has not been used for a prolonged period.
- Perform adjustment when the lighting conditions or brightness changes.

Either "AWB" (automatic white balance adjustment) which initiates automatic adjustment when the <AWB> button on the controller has been pressed or "ATW" (automatic tracking white balance adjustment) which constantly adjusts the white balance can be selected for adjustment purposes.

The results of the AWB adjustment can be stored in two memories, A and B, when [AWB A] or [AWB B] has been selected for the white balance.

- Once the white balance values have been adjusted, their setup procedure will be completed simply by selecting them using the camera menus or Web setup screen [Setup], or by pressing the buttons on the controller, provided that they are going to be used under the same conditions as the ones established when the values were set. There is no need to set it again.
- Once a new setting is entered, the previous setting will be erased.
- White balance adjustment is not possible in night mode.
- The white balance cannot be adjusted during preset playback.

Use the two memories to store settings corresponding to different shooting conditions.

## <NOTE>

- After adjusting the white balance, and [SERIAL] or [IP] of [TRACKING DATA OUTPUT] is set to [ON], the tracking data output may be delayed or the value may not be updated. (→ page 71)

## Automatic adjustment (AWB: AWB A or AWB B)

### When performing operations from a wireless remote control

1. Set the value for [PAINT] – [W/B BAL SETTING] – [WHITE BALANCE MODE] to either [AWB A] or [AWB B].

2. Shoot a white subject (such as a white wall or handkerchief) so that it fills the screen.

- Do not shoot shiny or very bright objects.

3. Press the <SET> button.

The auto white balance adjustment (AWB) is performed, and the white balance setting is entered.

- With [MONITOR DISPLAY] – [STATUS INDICATOR] – [STATUS(AUTO)] – [ON] and with [OUTPUT ITEM] for each output connector ([OUTPUT] – [12G SDI OUT/SFP+], etc.) set to [STATUS], when white balance adjustment finishes normally, "AWB OK" is displayed in the middle of the screen.

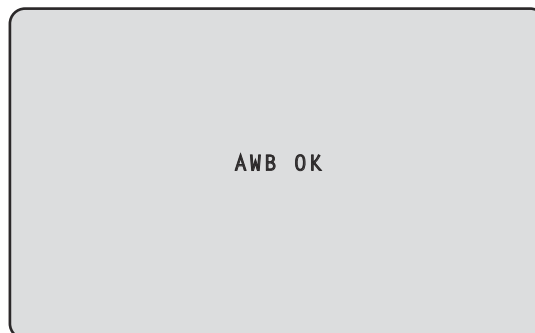

## <NOTE>

- Adjustment cannot be performed while the color bar is displayed. Switch to the camera image by pressing the <MODE> button.
- The white balance cannot be adjusted during preset playback.
- When the adjustment has failed, an error message such as "OUT RANGE NG", "HIGH LIGHT NG", "LOW LIGHT NG" or "ATW NG" is displayed.
- The results of AWB are displayed while you are viewing the OSD menu even if [OUTPUT ITEM] is not set to [STATUS].

### When performing operations from a controller

#### When using an AW-RP150 or AW-RP60

For details, refer to the operating instructions for the controller.

## <NOTE>

- White balance may not be correctly set if the lighting of the object is too weak.
- Since the unit has a built-in memory, the set white balance will remain in the memory even if power is turned off. Therefore, it is not necessary to reset the white balance if the color temperature of those objects remains unchanged. However, it must be reset if the color temperature changes, such as when you move from indoors to outside, or vice versa.

## White balance adjustment (continued)

---

### Auto tracking white adjustment (ATW)

When the white balance adjustment is set to [ATW], the white balance continues to be adjusted automatically all the time, and it is automatically corrected even when the light source or color temperature has changed to produce completely natural pictures.

This functions when [PAINT] – [W/B BALANCE SETTING] – [ATW] is set to [ON].

#### <NOTE>

- ATW might not function properly when high brightness light (ex. fluorescent lamp) beams into a screen.
- White balance may not be accurately set if there is no white object in the scene being shot.
- The white balance may shift out of adjustment when different kinds of light sources such as sunlight and fluorescent lighting are applied.

### 3200K and 5600K presets

When [3200K] or [5600K] is selected for the white balance, the white balance is set using a color temperature of 3200 K (equivalent to halogen light) or 5600 K (equivalent to daylight), respectively.

This function works when [3200K] or [5600K] is selected instead of [AWB A] or [AWB B] by following the steps for “Automatic adjustment” in “White balance adjustment” (→ page 44).

### VAR

When [VAR] is selected for the white balance, you can select a color temperature between 2000K and 15000K.

#### <NOTE>

- The displayed [VAR] value does not guarantee an absolute value. Use the value as a reference.

## Black balance adjustment

---

Adjust the zero levels of the three primary colors (RGB) to reproduce black accurately. If the black balance is out of adjustment, not only will black be reproduced poorly, but the color tones of the screen as a whole will also be degraded.

Readjustment of the black balance is not required under normal circumstances but is necessary in the following situations.

- Perform adjustment when using the unit for the first time or when the unit has not been used for a prolonged period.
- Perform adjustment when the ambient temperature changes significantly, such as during changes of the season.

### <NOTE>

- After adjusting the black balance, and [SERIAL] or [IP] of [TRACKING DATA OUTPUT] is set to [ON], the tracking data output may be delayed or the value may not be updated. (→ page 71)

## Automatic adjustment

### When performing operations from a wireless remote control

---

In Step 3 for “Automatic adjustment” (→ page 44) of “White balance adjustment”, when you press and hold the <SET> button for approximately 2 seconds, auto black balance adjustment (ABB) is executed and the black balance is set.

When this takes place, the lens is closed and then the adjustment is performed so the screen will temporarily turn black.

- When the black balance adjustment is completed successfully, the “ABB OK” message appears at the center of the screen.



### <NOTE>

- Adjustment cannot be performed while the color bar is displayed. Switch to the camera image by pressing the <MODE> button.
- The black balance cannot be adjusted during preset playback.

### When performing operations from a controller

---

#### When using an AW-RP150 or AW-RP60

For details, refer to the operating instructions for the controller.

## Black level (master pedestal) adjustment

---

The black level can be adjusted when using a multiple number of cameras including the unit. Ask your dealer to perform this adjustment. (Use an oscilloscope or waveform monitor for the adjustment.)

Adjust the black level in accordance with the units and devices used.

### When performing operations from a wireless remote control

---

1. Press the <IRIS MANU> button.  
Set the iris to the manual mode.
2. Press the <IRIS →> button.  
The lens iris is stopped down.
3. Adjust the value in [PAINT] – [PEDESTAL] – [MASTER PEDESTAL] to adjust the black level so that it is the same as the others.  
Fine adjustments are available with the [R PEDESTAL]/[G PEDESTAL]/[B PEDESTAL] settings, etc.

### When performing operations from a controller

---

#### When using an AW-RP150 or AW-RP60

For details, refer to the operating instructions for the controller.

# Genlock adjustment

The genlock adjustment is performed to achieve phase alignment by applying external synchronization (genlock) when a multiple number of cameras will be used or when the unit will be used in combination with other devices.

This unit supports BBS (Black Burst Sync) and tri-level sync external synchronization signals.

By setting [BASIC CONFIG] – [SYNC SIGNAL] – [REF SIGNAL] to [BBS/TRI-LEVEL SYNC], it is possible to synchronize with the external synchronization signal output from the G/L connector.

Ask your dealer to perform this adjustment.

(Use a dual-trace oscilloscope for the adjustment.)

## Horizontal phase adjustment

Observe the waveforms of the external sync signal input (tri-level sync signal) and video signal output on the dual-trace oscilloscope, and use the wireless remote control or controller to bring the horizontal phase into alignment.

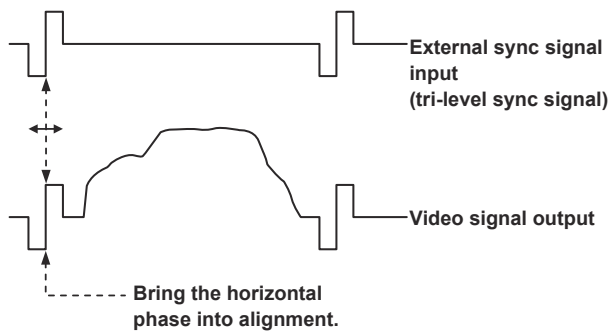

Example: When the tri-level sync phase is adjusted

It is possible to adjust the horizontal phase by changing the values in [BASIC CONFIG] – [SYNC SIGNAL] – [GEN-LOCK] – [H PHASE-COARSE] and [H PHASE-FINE].

# Camera menu items

## Top Menu screen

### BASIC CONFIG

Set basic configuration items for the camera (system configuration items).

### NETWORK

Set basic configuration items related to networks.

### OUTPUT

Set items for the various output connectors.

### RETURN

Set items related to return images.

### AUDIO

Set items related to audio.

### IP SIGNAL

Set items related to IP related image/audio output.

### PAINT

Set items related to camera images.

### LENS

Set items related to lenses.

### MONITOR DISPLAY

Set items for status indicators/indication displays, etc.

### TRACKING DATA OUTPUT

Set items related to tracking data output.

### CROP

Set items related to CROP (cropping).

### PAN/TILT

Set items related to PAN/TILT.

### PRESET

Set items related to PRESET.

### FILES

Set items related to SCENE file/USER file.

### MAINTENANCE

Set items related to maintenance.

#### <NOTE>

- During IP video transmission (H.264/H.265/M-JPEG), there may be some delays in OSD menu operations. Smooth OSD menu operations become possible when you set [IP SIGNAL] – [IP(H.264/H.265)] – [CHAR] to [OFF]. (→ page 58, page 124)

## BASIC CONFIG

### FREQUENCY

#### [60Hz, 59.94Hz, 50Hz, 24Hz, 23.98Hz]

This item is selected to switch the frame frequency.

- For details on how to change the frequency, refer to “Changing the frequency” (→ page 50).

### FORMAT

#### For [60Hz]

2160/60p, 1080/60p

#### For [59.94Hz]

2160/59.94p, 2160/29.97p, 1080/119.88p, 1080/59.94p, 1080/29.97p, 720/59.94p

#### For [50Hz]

2160/50p, 2160/25p, 1080/100p, 1080/50p, 1080/25p, 720/50p

#### For [24Hz]

2160/24p, 1080/24p

#### For [23.98Hz]

2160/23.98p, 1080/23.98p

#### <NOTE>

- Streaming stops when changing the system format.
- For details on how to change the format, refer to “Changing the format” (→ page 51).

### SFP+ MODE [12G OUTPUT, ST2110]

Set the operating mode for the SFP+ connector.

12G OUTPUT	The same video signal is output as the video output from the 12G SDI OUT connector.
ST2110	Video/audio data that conforms with SMPTE ST2110 is output.

#### <NOTE>

- This unit automatically restarts when [SFP+ MODE] is changed.
- The following functions cannot be used when [12G OUTPUT] is selected:
  - SMPTE ST2110 video/audio output
  - SMPTE ST2110 video input (RETURN) (→ page 58)
  - PTP synchronizing (→ page 50)

### V-LOG [OFF, ON]

Set the V-LOG mode.

OFF	This setting allows detailed picture quality adjustments on the camera.
ON	Set a gamma curve that provides broad tones and a wide range of latitude (exposure range). Grading will be necessary after shooting.

#### <NOTE>

- This cannot be set when the [BASIC CONFIG] – [HDR] is [ON].
- Functions to adjust picture quality are limited when [BASIC CONFIG] – [V-LOG] is [ON].

### V-LOG PAINT SW [OFF, ON]

Select whether to make it possible to make settings in the [PAINT] menu when [BASIC CONFIG] – [V-LOG] is [ON].

#### <NOTE>

- This cannot be set when the [BASIC CONFIG] – [V-LOG] is [OFF].

### HDR [OFF, ON]

Enable/disable the HDR mode.

#### <NOTE>

- This cannot be set when the [BASIC CONFIG] – [V-LOG] is [ON].



## Camera menu items (continued)

### GAMUT [NORMAL, WIDE\_G2]

Set the color gamut.

NORMAL	BT.709 equivalent color gamut.
WIDE_G2	BT.2020 equivalent color gamut.

#### <NOTE>

- This cannot be set when the [BASIC CONFIG] – [HDR] is [OFF].

### SHOOTING MODE [NORMAL, LOW LIGHT]

Select the shooting mode to suit the shooting environment.

NORMAL	Select this when shooting in an environment with normal brightness.
LOW LIGHT	Select this for high sensitivity shooting. (Suited to shooting in dark environments.)

#### <NOTE>

- The black level may vary when [LOW LIGHT] is selected, but this does not indicate a problem with camera performance.

### SERIAL CONNECTION

#### BAUD RATE [9600bps, 38400bps, 115200bps]

Set the communication speed (baud rate) for the RS-422 connector.

#### <NOTE>



- This item is disabled when [TRACKING DATA OUTPUT] – [SERIAL] is [ON].

### BAR [OFF, ON]

OFF	Outputs camera images.
ON	Outputs the color bar.

### COLOR BAR TYPE [TYPE1, TYPE2, TYPE3, TYPE4, TYPE5]

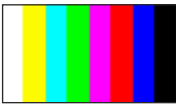
Select the type of color bar to display.

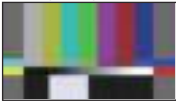
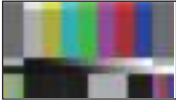
COLOR BAR TYPE		Output color bar	
		IP transmissions (H.264/H.265/M-JPEG)	SDI/HDMI or SMPTE ST2110/High bandwidth NDI
TYPE1	SMPTE 	TYPE1	SDI/HDMI
			TYPE1
TYPE2	FULL 	TYPE2	SDI/HDMI
			TYPE2
TYPE3	ARIB(FHD) 	TYPE1	SDI/HDMI
			TYPE3
TYPE4	ARIB(UHD) 	TYPE1	SDI/HDMI
			TYPE3
TYPE5	ARIB(2020/HLG) 	TYPE1	SDI/HDMI
			TYPE3

#### <NOTE>

- When [BAR] is [ON], the color bars of the various HDR/GAMUT/V-LOG setting screens are output as color bars with [HDR] [OFF]/[V-LOG] [OFF].
- Color bars of IP transmissions (H.264/H.265/M-JPEG) do not conform with SMPTE.

- BAR ID (→ page 50) is not output with [TYPE4]/[TYPE5].
- With [TYPE4], 2020 is output even when set to 709.
- TYPE3/TYPE4/TYPE5 are not output with IP transmission modes (H.264/H.265/M-JPEG).
- TYPE4/TYPE5 are not output with SMPTE ST2110 and High bandwidth NDI.

### TEST TONE [OFF, ON]

Make the settings for the test tone signal (1 kHz) output while the color bar is displayed.

OFF	Test tone is not output.
ON	Test tone is output.

### TALLY

#### TALLY [ENABLE, DISABLE]

Set whether to disable [DISABLE]/enable [ENABLE] the function that makes the tally lamps turn on or turn off with the tally control signal.

#### TALLY BRIGHTNESS [LOW, MID, HIGH]

Adjust the brightness of the tally LEDs.

#### TALLY GUARD [OFF, ON]

The following functions are suppressed only during input of the R tally signal:

- Auto white balance and auto black balance operation
- OSD menu display
- OSD status indicators

#### TALLY LED LIMIT

Set whether to limit the lighting of the tally lamps for each of the tally control signal colors (R/G/Y).

#### R [LIMIT, UNLIMIT]

#### G [LIMIT, UNLIMIT]

#### Y [LIMIT, UNLIMIT]

LIMIT	Limit the lighting of the tally lamps.
UNLIMIT	Light the tally lamps.

#### <NOTE>

- If [LIMIT] is selected for [TALLY LED LIMIT], only the tally lamps of this unit are limited. The tally status display on external devices (the AW-RP150, AW-RP60 controller, etc.) remains enabled.

### EXTERNAL OUTPUT

Select the type of signal to be output from the External Output signal lines (Output1 and Output2) of the RS-422 connector. (→ page 20)

#### OUTPUT1

#### [OFF, R-TALLY, G-TALLY, Y-TALLY]

#### OUTPUT2

#### [OFF, R-TALLY, G-TALLY, Y-TALLY]

OFF	Signal is not output.
R-TALLY	The reception status of the red tally signal is output.
G-TALLY	The reception status of the green tally signal is output.
Y-TALLY	The reception status of the yellow tally signal is output.

### TSL5.0

Make settings related to TSL protocol version 5.0.

With the TSL5.0 function, set the information required to control the tallies of this unit from a device that supports the TSL5.0 protocol.

#### INDEX NO. [1 to 65534]

By matching the INDEX set on the TSL5.0 control device and the Index number of this unit, you can control the tallies of this unit individually.

#### PORT [1 to 65535]

Set the port number that will receive controls via the TSL5.0 protocol.

## Camera menu items (continued)

### SYNC SIGNAL

Make settings to synchronize video/audio output signals.

#### REF SIGNAL [BBS/TRI-LEVEL SYNC, PTP]

BBS/TRI-LEVEL SYNC	Synchronization is according to the SDI reference signal from the G/L connector.
PTP	Synchronization is according to the PTP from the SFP+ connector.

#### <NOTE>

- [PTP] cannot be selected if the SMPTE ST2110 software key (AW-SFU60) is disabled.
- When [BASIC CONFIG] – [SFP+ MODE] is [12G OUTPUT], [PTP] cannot be selected.
- When [IP SIGNAL] – [ST2110] – [MOIP MODE] is [OFF], [PTP] cannot be selected.

### GEN-LOCK

Adjust the phase.

#### H PHASE-COURSE [-5 to 5]

Make coarse adjustments to horizontal phase in genlock.

#### H PHASE-FINE [-100 to 100]

Make fine adjustments to horizontal phase in genlock.

#### <NOTE>

- This cannot be set when the [BASIC CONFIG] – [SYNC SIGNAL] – [REF SIGNAL] is [PTP].

### BAR ID

#### BAR ID [OFF, ON]

Select OFF/ON for the ID display on the color bar.

#### BRIGHTNESS [0 to 100%]

Set the text color for the camera ID on the color bar.

#### ID1 POSITION V [0 to 5]

Specify the font units for the start position for display of the camera ID1 (vertically: line number) on the color bar.

#### ID1 POSITION H [0 to 15]

Specify the font units for the start position for display of the camera ID1 (horizontally: column number) on the color bar.

#### ID1

Set the character string for the [BAR ID].

Maximum 16 characters

(Alphanumeric characters, spaces, ! # % & ' ( ) \* + , - . / : ; < = > ? [ ] \_ ~ \$ @ )

#### ID2 POSITION V [0 to 5]

Specify the font units for the start position for display of the camera ID2 (vertically: line number) on the color bar.

#### ID2 POSITION H [0 to 15]

Specify the font units for the start position for display of the camera ID2 (horizontally: column number) on the color bar.

#### ID2

Set the character string for the [BAR ID].

Maximum 16 characters

(Alphanumeric characters, spaces, ! # % & ' ( ) \* + , - . / : ; < = > ? [ ] \_ ~ \$ @ )

#### OFFSET V [0 to 89]

Make fine adjustments to the display position of the [BAR ID] (offset position of the pixels in the font: vertically).

#### OFFSET H [0 to 79]

Make fine adjustments to the display position of the [BAR ID] (offset position of the pixels in the font: horizontally).

#### <NOTE>

- BAR ID is displayed only through the SDI, HDMI, SMPTE ST2110, and High bandwidth NDI outputs. It is not displayed with IP transmission (H.264/H.265/M-JPEG).

### ■ Changing the frequency

When the currently selected frequency is changed in [FREQUENCY], the pre-frequency-change confirmation screen appears.

#### Pre-frequency-change confirmation screen

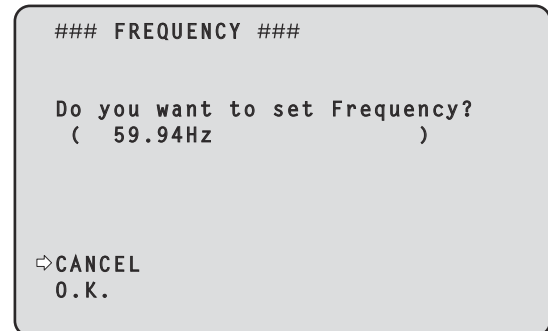

- The frequency to be set is displayed within the parentheses on the screen.
- When you move the cursor to [O.K.] on the pre-frequency-change confirmation screen and confirm, the frequency is changed.

#### <NOTE>

- When using a monitor that does not support 60Hz/59.94Hz/50Hz/24Hz/23.98Hz frequencies, images may not be displayed after the frequency is changed. Before changing the frequency, verify that your monitor supports the frequency.
- When Frequency is changed, the unit restarts.

### ■ Changing the format

When the currently selected format is changed in [FORMAT], the pre-format-change confirmation screen appears.

#### Pre-format-change confirmation screen

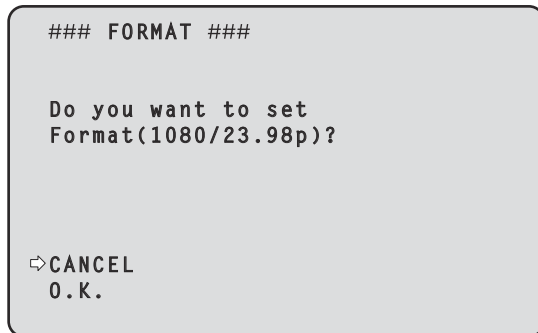

- The format to be set is displayed within the parentheses on the screen.
- When you move the cursor to [O.K.] on the pre-format-change confirmation screen and confirm, the post-format-change confirmation screen appears.

#### Post-format-change confirmation screen

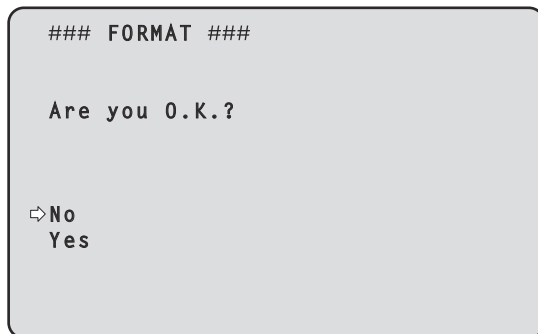

- When confirmed with the cursor on [Yes], the screen returns to the [FORMAT] selection screen in the post-format-change format.
- When confirmed with the cursor on [No], the screen returns to the [FORMAT] selection screen after changing back to the pre-format-change format.
- The same occurs if an operation is not performed within 30 seconds.
- When Format is changed, IP video transmission is stopped.
- When Format is changed, the Format for each output terminal (12G SDI OUT, 3G SDI OUT, HDMI) is reset to its predefined value.

## NETWORK

### LAN

Make a variety of settings related to the LAN connector.

#### DHCP [OFF, ON]

Set DHCP OFF/ON.

#### IP ADDRESS

Set the IP address for this unit.

The set value is applied to this unit when [SET EXECUTE] is executed.

#### SUBNET MASK

Set the subnet mask for this unit.

The set value is applied to this unit when [SET EXECUTE] is executed.

#### DEFAULT GATEWAY

Set the default gateway for this unit.

The set value is applied to this unit when [SET EXECUTE] is executed.

#### MAC ADDRESS

The MAC address of this unit is displayed.

### SFP+

Make a variety of settings related to the SFP+ connector.

#### <NOTE>

- This cannot be set when the [BASIC CONFIG] – [SFP+ MODE] is [12G OUTPUT].

#### DHCP [OFF, ON]

Set DHCP OFF/ON.

#### IP ADDRESS

Set the IP address for this unit.

The set value is applied to this unit when [SET EXECUTE] is executed.

#### SUBNET MASK

Set the subnet mask for this unit.

The set value is applied to this unit when [SET EXECUTE] is executed.

#### DEFAULT GATEWAY

Set the default gateway for this unit.

The set value is applied to this unit when [SET EXECUTE] is executed.

#### MAC ADDRESS

The MAC address of this unit is displayed.

### USB

Make a variety of settings related to the USB connector.

#### DHCP [OFF, ON]

Set DHCP OFF/ON.

#### IP ADDRESS

Set the IP address for this unit.

The set value is applied to this unit when [SET EXECUTE] is executed.

#### SUBNET MASK

Set the subnet mask for this unit.

The set value is applied to this unit when [SET EXECUTE] is executed.

## Camera menu items (continued)

### DEFAULT GATEWAY

Set the default gateway for this unit.

The set value is applied to this unit when [SET EXECUTE] is executed.

### COMMON SETTING

#### DNS [MANUAL, AUTO]

Set whether the DNS server address and domain name are to be acquired automatically [AUTO] or to be input manually [MANUAL]. The DNS setting needs to be performed if [MANUAL] is set. When using the DHCP function, if you set to [AUTO], then the DNS server address will be acquired automatically. Consult the system administrator regarding the settings.

#### PRIMARY

#### SECONDARY

#### DOMAIN

Display the IP address/domain name for the DNS server.

The settings cannot be changed in the OSD menu, so change them from the web screen if they are to be changed.

#### HTTP PORT [1 to 65535]

Allocate the port numbers individually.

The following port numbers cannot be set because they are used by this unit:

20, 21, 23, 25, 42, 53, 67, 68, 69, 110, 123, 161, 162, 443, 546, 547, 554, 995, 5960 to 5985, 7960 to 8060, 10669, 10670, 11900, 59000 to 61000

#### HTTPS PORT [1 to 65535]

Allocate the port numbers individually.

The following port numbers cannot be set because they are used by this unit:

20, 21, 23, 25, 42, 53, 67, 68, 69, 80, 110, 123, 161, 162, 546, 547, 554, 995, 5960 to 5985, 7960 to 8060, 10669, 10670, 11900, 59000 to 61000

## OUTPUT

### 12G SDI OUT/SFP+

Make the settings for output from the 12G SDI OUT/SFP+ connector.

#### FORMAT SELECT

Set the output format.

The following formats can be set depending on the settings in [FORMAT] in [BASIC CONFIG].

Frequency	System Format	Format (12G SDI OUT/SFP+)
60Hz	2160/60p	2160/60p 1080/60p
	1080/60p	1080/60p
59.94Hz	2160/59.94p	2160/59.94p 1080/59.94p*1
	2160/29.97p	2160/29.97p 1080/29.97p
	1080/119.88p	1080/59.94p*3
	1080/59.94p	1080/59.94p 1080/59.94i
	1080/29.97p	1080/29.97p
	720/59.94p	720/59.94p
50Hz	2160/50p	2160/50p 1080/50p*2
	2160/25p	2160/25p 1080/25p
	1080/100p	1080/50p*3
	1080/50p	1080/50p 1080/50i
	1080/25p	1080/25p
	720/50p	720/50p
24Hz	2160/24p	2160/24p 1080/24p
	1080/24p	1080/24p
23.98Hz	2160/23.98p	2160/23.98p 1080/23.98p
	1080/23.98p	1080/23.98p

\*1 When [UHD CROP] is [CROP(720)], output is 720/59.94p.

\*2 When [UHD CROP] is [CROP(720)], output is 720/50p.

\*3 For 119.88p (or 100p), "Frame 1" is output with the frame rate cut to half (59.94p (or 50p)).

#### HDR OUTPUT SELECT

##### [SDR(709), HDR(709), HDR(2020)]

Select the signal output when [HDR] is [ON].

SDR(709)	Selects the SDR output signal.
HDR(709)	Selects the HDR output signal (BT.709 equivalent color gamut).
HDR(2020)	Selects the HDR output signal (BT.2020 equivalent color gamut).

#### <NOTE>

- This cannot be set when the [BASIC CONFIG] – [HDR] is [OFF].
- [HDR(2020)] can be selected only when [BASIC CONFIG] – [GAMUT] is [WIDE\_G2].

## Camera menu items (continued)

### V-LOG OUTPUT SELECT [V-LOG, V-709]

Select the signal output when [V-LOG] is [ON].

V-LOG	Output with a gamma curve that has a wide range of tones and latitude (exposure range).
V-709	Converted for output to images suited to previewing.

#### <NOTE>

- This cannot be set when the [BASIC CONFIG] – [V-LOG] is [OFF].

### OUTPUT ITEM [MENU ONLY, STATUS]

Select the type of OSD to be superimposed on output video.

MENU ONLY	Displays the OSD menu only.
STATUS	Displays the OSD menu and OSD status.

### CHAR [OFF, ON]

Set whether to superimpose the OSD.

### 3G SDI [LEVEL-A, LEVEL-B]

When [FORMAT SELECT] (12G SDI OUT/SFP+) is [1080/59.94p], [1080/60p] or [1080/50p], select the format for outputting 3G SDI signals.

#### <NOTE>

- [3G SDI] cannot be changed if [FORMAT SELECT] (12G SDI OUT/SFP+) is other than [1080/59.94p], [1080/60p] or [1080/50p].

### 3G SDI OUT1

Make the settings for output from the 3G SDI OUT1 connector.

#### FORMAT SELECT

Set the output format.

The following formats can be set depending on the settings in [FORMAT] in [BASIC CONFIG].

Frequency	System Format	Format (3G SDI OUT1)
60Hz	2160/60p	1080/60p
	1080/60p	1080/60p
59.94Hz	2160/59.94p	1080/59.94p* <sup>1</sup> 1080/59.94i* <sup>1</sup>
	2160/29.97p	1080/29.97p
	1080/119.88p	1080/59.94p* <sup>3</sup>
	1080/59.94p	1080/59.94p 1080/59.94i
	1080/29.97p	1080/29.97p
	720/59.94p	720/59.94p
50Hz	2160/50p	1080/50p* <sup>2</sup> 1080/50i* <sup>2</sup>
	2160/25p	1080/25p
	1080/100p	1080/50p* <sup>3</sup>
	1080/50p	1080/50p 1080/50i
	1080/25p	1080/25p
	720/50p	720/50p
24Hz	2160/24p	1080/24p
	1080/24p	1080/24p
23.98Hz	2160/23.98p	1080/23.98p
	1080/23.98p	1080/23.98p

\*<sup>1</sup> When [UHD CROP] is [CROP(720)], output is 720/59.94p.

\*<sup>2</sup> When [UHD CROP] is [CROP(720)], output is 720/50p.

\*<sup>3</sup> For 119.88p (or 100p), "Frame 1" is output with the frame rate cut to half (59.94p (or 50p)).

### HDR OUTPUT SELECT

#### [SDR(709), HDR(709), HDR(2020)]

Select the signal output when [HDR] is [ON].

SDR(709)	Selects the SDR output signal.
HDR(709)	Selects the HDR output signal (BT.709 equivalent color gamut).
HDR(2020)	Selects the HDR output signal (BT.2020 equivalent color gamut).

#### <NOTE>

- This cannot be set when the [BASIC CONFIG] – [HDR] is [OFF].
- [HDR(2020)] can be selected only when [BASIC CONFIG] – [GAMUT] is [WIDE\_G2].

### V-LOG OUTPUT SELECT [V-LOG, V-709]

Select the signal output when [V-LOG] is [ON].

V-LOG	Output with a gamma curve that has a wide range of tones and latitude (exposure range).
V-709	Converted for output to images suited to previewing.

#### <NOTE>

- This cannot be set when the [BASIC CONFIG] – [V-LOG] is [OFF].

## Camera menu items (continued)

### OUTPUT ITEM [MENU ONLY, STATUS]

Select the type of OSD to be superimposed on output video.

MENU ONLY	Displays the OSD menu only.
STATUS	Displays the OSD menu and OSD status.

### CHAR [OFF, ON]

Set whether to superimpose the OSD.

### 3G SDI [LEVEL-A, LEVEL-B]

When [FORMAT SELECT] (3G SDI OUT1) is [1080/59.94p], [1080/60p] or [1080/50p], select the format for outputting 3G SDI signals.

#### <NOTE>

- [3G SDI] cannot be changed if [FORMAT SELECT] (3G SDI OUT1) is other than [1080/59.94p], [1080/60p] or [1080/50p].

### 3G SDI OUT2/PM

Make the settings for output from the 3G SDI OUT2/PM connector.

#### OUTPUT SELECT [CAM, RETURN]

Switch between outputting the camera images and the images received through RETURN (images input through SMPTE ST2110).

CAM	Outputs camera input images.
RETURN	Outputs images received through RETURN (SMPTE ST2110 input images).

#### <NOTE>

- This cannot be set when [BASIC CONFIG] – [FORMAT] is other than [1080/59.94p] or [1080/50p].
- This cannot be set when the [BASIC CONFIG] – [SFP+ MODE] is [12G OUTPUT].
- This cannot be set when [CROP] – [UHD CROP] is [CROP(1080)] or [CROP(720)].
- This item cannot be set if the SMPTE ST2110 software key (AW-SFU60) is disabled.

#### FORMAT SELECT

Set the output format.

The following formats can be set depending on the settings in [FORMAT] in [BASIC CONFIG].

Frequency	System Format	Format (3G SDI OUT2/PM)
60Hz	2160/60p	1080/60p
	1080/60p	1080/60p
59.94Hz	2160/59.94p	1080/59.94p*1 1080/59.94i*1
	2160/29.97p	1080/29.97p
	1080/119.88p	1080/59.94p*3
	1080/59.94p	1080/59.94p 1080/59.94i
	1080/29.97p	1080/29.97p
	720/59.94p	720/59.94p
50Hz	2160/50p	1080/50p*2 1080/50i*2
	2160/25p	1080/25p
	1080/100p	1080/50p*3
	1080/50p	1080/50p 1080/50i
	1080/25p	1080/25p
	720/50p	720/50p
24Hz	2160/24p	1080/24p
	1080/24p	1080/24p
23.98Hz	2160/23.98p	1080/23.98p
	1080/23.98p	1080/23.98p

\*1 When [UHD CROP] is [CROP(720)], output is 720/59.94p.

\*2 When [UHD CROP] is [CROP(720)], output is 720/50p.

\*3 For 119.88p (or 100p), "Frame 2" is output with the frame rate cut to half (59.94p (or 50p)).

#### <NOTE>

- When [3G SDI OUT2/PM] – [OUTPUT SELECT] is [RETURN], the format displayed is the same as [IP SIGNAL] – [ST2110] – [RET VIDEO RX] and cannot be changed.

## Camera menu items (continued)

### HDR OUTPUT SELECT

[SDR(709), HDR(709), HDR(2020)]

Select the signal output when [HDR] is [ON].

SDR(709)	Selects the SDR output signal.
HDR(709)	Selects the HDR output signal (BT.709 equivalent color gamut).
HDR(2020)	Selects the HDR output signal (BT.2020 equivalent color gamut).

#### <NOTE>

- This cannot be set when the [BASIC CONFIG] – [HDR] is [OFF].
- [HDR(2020)] can be selected only when [BASIC CONFIG] – [GAMUT] is [WIDE\_G2].

### V-LOG OUTPUT SELECT [V-LOG, V-709]

Select the signal output when [V-LOG] is [ON].

V-LOG	Output with a gamma curve that has a wide range of tones and latitude (exposure range).
V-709	Converted for output to images suited to previewing.

#### <NOTE>

- This cannot be set when the [BASIC CONFIG] – [V-LOG] is [OFF].

### OUTPUT ITEM [MENU ONLY, STATUS]

Select the type of OSD to be superimposed on output video.

MENU ONLY	Displays the OSD menu only.
STATUS	Displays the OSD menu and OSD status.

### CHAR [OFF, ON]

Set whether to superimpose the OSD.

### 3G SDI [LEVEL-A, LEVEL-B]

When [FORMAT SELECT] (3G SDI OUT2/PM) is [1080/59.94p], [1080/60p] or [1080/50p], select the format for outputting 3G SDI signals.

#### <NOTE>

- [3G SDI] cannot be changed if [FORMAT SELECT] (3G SDI OUT2/PM) is other than [1080/59.94p], [1080/60p] or [1080/50p].

## HDMI

Make the settings for output from the HDMI connector.

### FORMAT SELECT

Set the output format.

The following formats can be set depending on the settings in [FORMAT] in [BASIC CONFIG].

Frequency	System Format	Format (HDMI)
60Hz	2160/60p	2160/60p 1080/60p
	1080/60p	1080/60p
59.94Hz	2160/59.94p	2160/59.94p 1080/59.94p*1
	2160/29.97p	2160/29.97p 1080/29.97p
	1080/119.88p	1080/119.88p
	1080/59.94p	1080/59.94p 1080/59.94i
	1080/29.97p	1080/29.97p
	720/59.94p	720/59.94p
50Hz	2160/50p	2160/50p 1080/50p*2
	2160/25p	2160/25p 1080/25p
	1080/100p	1080/100p
	1080/50p	1080/50p 1080/50i
	1080/25p	1080/25p
	720/50p	720/50p
24Hz	2160/24p	2160/24p 1080/24p
	1080/24p	1080/24p
23.98Hz	2160/23.98p	2160/23.98p 1080/23.98p
	1080/23.98p	1080/23.98p

\*1 When [UHD CROP] is [CROP(720)], output is 720/59.94p.

\*2 When [UHD CROP] is [CROP(720)], output is 720/50p.

### HDR OUTPUT SELECT

[SDR(709), HDR(709), HDR(2020)]

Select the signal output when [HDR] is [ON].

SDR(709)	Selects the SDR output signal.
HDR(709)	Selects the HDR output signal (BT.709 equivalent color gamut).
HDR(2020)	Selects the HDR output signal (BT.2020 equivalent color gamut).

#### <NOTE>

- This cannot be set when the [BASIC CONFIG] – [HDR] is [OFF].
- [HDR(2020)] can be selected only when [BASIC CONFIG] – [GAMUT] is [WIDE\_G2].

## Camera menu items (continued)

### V-LOG OUTPUT SELECT [V-LOG, V-709]

Select the signal output when [V-LOG] is [ON].

V-LOG	Output with a gamma curve that has a wide range of tones and latitude (exposure range).
V-709	Converted for output to images suited to previewing.

#### <NOTE>

- This cannot be set when the [BASIC CONFIG] – [V-LOG] is [OFF].

### VIDEO SAMPLING [4:2:2/10bit, 4:2:0/8bit]

When [FORMAT SELECT] in [HDMI] is [2160/59.94p], [2160/60p] or [2160/50p], select the video sampling output from the HDMI connector.

#### <NOTE>

- When [FORMAT SELECT] in [HDMI] is other than [2160/59.94p], [2160/60p] or [2160/50p], [VIDEO SAMPLING] cannot be changed and is fixed at [4:2:2/10bit].

### CHAR [OFF, ON]

Set whether to superimpose the OSD.

## RETURN

### RETURN1 ID

You can give a name to the return images (SMPTE ST2110 input images).

It can be 5 characters.

Alphanumeric characters, spaces, ! # % & ' ( ) \* + , - . / : ; < = > ? [ ] \_ ~ \$ @ |

The name you set is superimposed on the images output from the same connector when [RETURN] is selected in [OUTPUT] – [3G SDI OUT2/PM] – [OUTPUT SELECT].

#### <NOTE>

- This item cannot be set if the SMPTE ST2110 software key (AW-SFU60) is disabled.

## AUDIO

### AUDIO [OFF, ON]

Turn AUDIO input OFF/ON.

### INPUT1 SETTING

#### INPUT SELECT [LINE, MIC, MIC+48V]

Set the input switching for AUDIO INPUT1.

LINE	Sets to LINE input.
MIC	Sets to microphone input.
MIC+48V	Sets to phantom power supply +48V microphone input.

This is only enabled when [AUDIO] is set to [ON].

#### MIC GAIN [60dB, 40dB]

Set the microphone amplifier gain for the AUDIO INPUT1 microphone input.

This is enabled only when [AUDIO] – [INPUT1 SETTING] – [INPUT SELECT] is [MIC] or [MIC+48V].

#### LINE LEVEL [+4dB, 0dB]

Set the input level for the AUDIO INPUT1 line input.

This is only enabled when [AUDIO] – [INPUT1 SETTING] – [INPUT SELECT] is set to [LINE].

### INPUT2 SETTING

#### INPUT SELECT [LINE, MIC, MIC+48V]

Set the input switching for AUDIO INPUT2.

LINE	Sets to LINE input.
MIC	Sets to microphone input.
MIC+48V	Sets to phantom power supply +48V microphone input.

This is only enabled when [AUDIO] is set to [ON].

#### MIC GAIN [60dB, 40dB]

Set the microphone amplifier gain for the AUDIO INPUT2 microphone input.

This is enabled only when [AUDIO] – [INPUT2 SETTING] – [INPUT SELECT] is [MIC] or [MIC+48V].

#### LINE LEVEL [+4dB, 0dB]

Set the input level for the AUDIO INPUT2 line input.

This is only enabled when [AUDIO] – [INPUT2 SETTING] – [INPUT SELECT] is set to [LINE].



## Camera menu items (continued)

### OUTPUT SETTING

Display the setting status of audio output.

#### CH SELECT [INPUT1/INPUT2, INPUT1, INPUT2]

Select the audio output destination.

INPUT1/INPUT2	CH1-INPUT1/CH2-INPUT2
INPUT1	CH1-INPUT1/CH2-INPUT1
INPUT2	CH1-INPUT2/CH2-INPUT2

#### <NOTE>

- When [CH SELECT] is [INPUT1], the INPUT2 AUDIO TX of ST2110 is not output.
- When [CH SELECT] is [INPUT2], the INPUT1 AUDIO TX of ST2110 is not output.

#### CH1 VOLUME LEVEL

**[-40dB to 0dB to +20dB (1dB step)]**

Set the volume for CH1 audio output.

#### CH2 VOLUME LEVEL

**[-40dB to 0dB to +20dB (1dB step)]**

Set the volume for CH2 audio output.

#### HEAD ROOM [FS-12dB, FS-18dB, FS-20dB]

Set the audio head room (base level).

FS-12dB	-12dBFS
FS-18dB	-18dBFS
FS-20dB	-20dBFS

### ST2110 AUDIO FORMAT

#### INPUT1 [1ms/8ch, 0.125ms/8ch]

Set the format for AUDIO (INPUT1) of SMPTE ST2110.

#### INPUT2 [1ms/8ch, 0.125ms/8ch]

Set the format for AUDIO (INPUT2) of SMPTE ST2110.

#### <NOTE>

- This item cannot be set if the SMPTE ST2110 software key (AW-SFU60) is disabled.
- This cannot be set when the [BASIC CONFIG] – [SFP+ MODE] is [12G OUTPUT].

## IP SIGNAL

### NDI

Make a variety of settings related to High bandwidth NDI images.

#### FORMAT SELECT

Set the output format.

Frequency	System Format	Format (NDI)
60Hz	2160/60p	2160/60p* <sup>9</sup> 1080/60p
	1080/60p	1080/60p
59.94Hz	2160/59.94p	2160/59.94p* <sup>1,2</sup> 1080/59.94p
	2160/29.97p	2160/29.97p* <sup>3</sup> 1080/29.97p
	1080/119.88p	1080/59.94p* <sup>10</sup>
	1080/59.94p	1080/59.94p
	1080/29.97p	1080/29.97p
	720/59.94p	720/59.94p
50Hz	2160/50p	2160/50p* <sup>4,5</sup> 1080/50p
	2160/25p	2160/25p* <sup>6</sup> 1080/25p
	1080/100p	1080/50p* <sup>10</sup>
	1080/50p	1080/50p
	1080/25p	1080/25p
	720/50p	720/50p
24Hz	2160/24p	2160/24p* <sup>7</sup> 1080/24p
	1080/24p	1080/24p
23.98Hz	2160/23.98p	2160/23.98p* <sup>8</sup> 1080/23.98p
	1080/23.98p	1080/23.98p

\*<sup>1</sup> When [UHD CROP] is [CROP(1080)], output is 1080/59.94p.

\*<sup>2</sup> When [UHD CROP] is [CROP(720)], output is 720/59.94p.

\*<sup>3</sup> When [UHD CROP] is [CROP(1080)], output is 1080/29.97p.

\*<sup>4</sup> When [UHD CROP] is [CROP(1080)], output is 1080/50p.

\*<sup>5</sup> When [UHD CROP] is [CROP(720)], output is 720/50p.

\*<sup>6</sup> When [UHD CROP] is [CROP(1080)], output is 1080/25p.

\*<sup>7</sup> When [UHD CROP] is [CROP(1080)], output is 1080/24p.

\*<sup>8</sup> When [UHD CROP] is [CROP(1080)], output is 1080/23.98p.

\*<sup>9</sup> When [UHD CROP] is [CROP(1080)], output is 1080/60p.

\*<sup>10</sup> For 119.88p (or 100p), "Frame 1" is output with the frame rate cut to half (59.94p (or 50p)).

#### <NOTE>

- OSD menus are not displayed in the output video from High bandwidth NDI.

### IP(H.264/H.265)

Make a variety of settings related to IP video transmission (H.264/H.265/M-JPEG).

#### OUTPUT ITEM [MENU ONLY, STATUS]

Select the type of OSD to be superimposed on output video.

MENU ONLY	Displays the OSD menu only.
STATUS	Displays the OSD menu and OSD status.

## Camera menu items (continued)

### CHAR [OFF, ON]

Set whether to superimpose the OSD.

#### <NOTE>

- During IP video transmission (H.264/H.265/M-JPEG), there may be some delays in OSD menu operations. Smooth OSD menu operations become possible when you set this item to [OFF].

### ST2110

Make a variety of settings and display changes related to the SMPTE ST2110 images.

#### <NOTE>

- This item cannot be set if the SMPTE ST2110 software key (AW-SFU60) is disabled.
- This cannot be set when the [BASIC CONFIG] – [SFP+ MODE] is [12G OUTPUT].

### MOIP MODE [OFF, ON]

Set OFF/ON for MOIP (SMPTE ST2110 video/audio input/output).

### MAIN VIDEO TX

#### FORMAT

Set the image format of the MAIN video signal of SMPTE ST2110.

Frequency	System Format	Format (ST2110)
59.94Hz	1080/59.94p	1080/59.94p 1080/59.94i
50Hz	1080/50p	1080/50p 1080/50i

For formats other than the above, there is display only and the settings cannot be changed.

#### <NOTE>

- Camera images without overlays such as OSD menus and CROP frames are output from MAIN VIDEO TX.
- When [MOIP MODE] is [OFF], MAIN VIDEO TX is not output. The image format is also not displayed.

### CROP VIDEO TX

#### FORMAT

Display the image format of the CROP video signal of SMPTE ST2110.

#### <NOTE>

- Camera images without overlays such as OSD menus are output from CROP VIDEO TX.
- When [MOIP MODE] is [OFF] and [UHD CROP] is set to [OFF], CROP VIDEO TX is not output. The image format is also not displayed.

### MONITOR VIDEO TX

#### FORMAT

Display the image format of the monitor video signal of SMPTE ST2110.

#### <NOTE>

- The OSD menu display with images output from MONITOR VIDEO TX of ST2110 is linked to the settings made in [OUTPUT] – [3G SDI OUT2/PM] – [CHAR] and [OUTPUT ITEM].
- When [MOIP MODE] is [OFF] and [OUTPUT] – [3G SDI OUT2/PM] – [OUTPUT SELECT] is set to [RETURN], MONITOR VIDEO TX is not output. The image format is also not displayed.

### RETURN VIDEO RX

#### FORMAT

Display the image format of the RETURN video signal of SMPTE ST2110.

#### <NOTE>

- RETURN VIDEO RX cannot be input when [MOIP MODE] is [OFF] and [BASIC CONFIG] – [FORMAT] is other than [1080/59.94p] or [1080/50p]. The image format is also not displayed.

## PAINT

### AUTO

Make settings for auto operation.

### AGC [OFF, ON]

Set the behavior of auto gain control.

### AUTO IRIS [OFF, ON]

Select whether to turn auto iris adjustment OFF/ON.

### ATW [OFF, ON]

Set the behavior of the auto tracking white balance function.

### AUTO SHUTTER [OFF, ON]

Set the behavior of auto shutter control.

### KNEE MODE [AUTO, MANUAL]

Set the operating mode for gradation compression (knee).

### GAIN SETTING

The image gain is adjusted here.

### GAIN [-6dB to 12dB]

The image gain is adjusted here.

In locations which are too dark, adjust the gain upward; conversely, in locations which are too bright, adjust it downward.

### AGC [OFF, ON]

Set the behavior of auto gain control.

### AGC MAX GAIN [6dB, 12dB]

Set the maximum amount of gain increase when [AGC] is working.

### FRAME MIX SW [OFF, ON]

Set the control for frame addition (gain increase using sensor storage).

### FRAME MIX [6dB, 12dB, 18dB, 24dB]

Set the frame addition (gain increase using sensor storage) amount. When frame addition is performed, it will appear as if the images are missing some frames.

This cannot be configured when the format is 2160/29.97p, 2160/23.98p, 2160/24p, 2160/25p, 1080/29.97p, 1080/23.98p, 1080/24p, 1080/25p, 1080/119.88p or 1080/100p.

#### <NOTE>

- Under discharge tube illumination, such as fluorescent and mercury-vapor lights, the brightness may change cyclically, colors may change, and horizontal stripes may flow up and down the image.
- When [FRAME MIX] is set to 6dB, 12dB, 18dB or 24dB, if you set [SHUTTER SW] to [ON], [FRAME MIX SW] is changed to [OFF].

### DAY/NIGHT [DAY, NIGHT]

Switch between standard shooting and night-vision shooting (shooting with infrared light).

DAY	Standard shooting (day mode)
NIGHT	Night-vision shooting (night mode)

#### <NOTE>

- In night mode, video output will be in black and white. In addition, the iris will be forcibly opened.
- White balance adjustment is not possible in night mode.
- ND filter switching is not possible in night mode.

## Camera menu items (continued)

### IRIS

#### AUTO IRIS [OFF, ON]

Set OFF/ON for auto iris adjustment.

OFF	Do not adjust iris automatically.
ON	Adjust iris automatically.

#### WINDOW SELECT [1 to 4]

Set the photometry range when [AUTO IRIS] is on.

Window images are as follows:



#### PICTURE LEVEL [-50 to +50]

This menu item is selected to set the target picture level for automatic exposure compensation.

This is enabled when any one of the following automatic exposure compensation functions are set to [ON].

- When [AUTO IRIS] is set to [ON]
- When [AUTO SHUTTER] is set to [ON]
- When [AGC] is set to [ON]

#### PEAK RATIO [0 to 100]

Set the peak value and average value ratio of the photometry when [AUTO IRIS] is on.

The larger the number in the setting value, the more there is a reaction to the peak within the iris detection window.

The smaller the number in the setting value, the more there is a reaction to the average value within the iris detection window.

#### AUTO IRIS CLOSE LIMIT [NORMAL, F8, F7, F5.6]

Set the control speed of the auto iris function.

NORMAL	Moves up to the normal position (the vicinity of F9).
F8	The limit is in the vicinity of F8.
F7	The limit is in the vicinity of F7.
F5.6	The limit is in the vicinity of F5.6.

#### IRIS SPEED [1 to 3]

Set the control speed of the iris function.

1	Control the iris at a slow speed.
2	Control the iris at a normal speed.
3	Control the iris at a fast speed.

### W/B BAL SETTING

#### ATW [OFF, ON]

Set the behavior of the auto tracking white balance function.

When set to [ON], the white balance is continuously and automatically adjusted, with compensation done automatically even if the light source and color temperature change.

#### WHITE BALANCE MODE

##### [AWB A, AWB B, 3200K, 5600K, VAR]

Set the white balance mode.

Select the mode when the coloring is not natural because of the nature of the light source or other factors.

If the white color serving as the reference can be recognized, subjects can be shot with natural coloring.

AWB A AWB B	When [AWB A] or [AWB B] is selected and the white balance is executed, the adjustment results obtained are stored in the memory selected. When [AWB A] or [AWB B] is then selected, the white balance stored in the selected memory can be recalled.
3200K	This is the white balance mode which is ideal when a 3200K halogen light is used as the light source.
5600K	This is the white balance mode which is ideal when 5600K sunlight or fluorescent lighting is used as the light source.
VAR	You can specify a color temperature between 2000K to 15000K.

#### W.BAL VAR [2000K to 15000K]

You can specify a color temperature between 2000K to 15000K.

#### ATW SPEED [NORMAL, SLOW, FAST]

Set the control speed of the ATW function.

NORMAL	Tracks at normal speed.
SLOW	Tracks at a speed slower than [NORMAL].
FAST	Tracks at a speed faster than [NORMAL].

#### ATW TARGET R [-10 to +10]

Make fine adjustments to the Rch output when converging with the auto tracking white balance operation.

#### ATW TARGET B [-10 to +10]

Make fine adjustments to the Bch output when converging with the auto tracking white balance operation.

#### SHOCKLESS WB SW [OFF, ON]

Set the control that either transitions instantly or transitions gradually when [WHITE BALANCE MODE] is switched.

OFF	Transitions instantly.
ON	Transitions gradually.

#### SHOCKLESS WB SPEED [1 to 5]

Set the transition speed when [WHITE BALANCE MODE] is switched.

## Camera menu items (continued)

### SHUTTER SPEED

#### SHUTTER SW [OFF, ON]

Set ON/OFF for the shutter function.

#### AUTO SHUTTER [OFF, ON]

Set ON/OFF for the automatic shutter.

#### AUTO SHUTTER LIMIT [1/100, 1/120, 1/250]

Set the maximum shutter value when AUTO SHUTTER is operating. This is only enabled when [AUTO SHUTTER] is set to [ON].

#### SHUTTER MODE [STEP, SYNCHRO]

Select the shutter mode.

STEP	The step shutter is set (the steps can be changed).
SYNCHRO	The synchro shutter is set (the setting can be changed continuously).

### SHUTTER SPEED

The shutter speeds that can be set are listed below.

	When [STEP] is selected as the [SHUTTER MODE]
60p/59.94p/ 59.94i mode	1/100, 1/120, 1/125, 1/250, 1/500, 1/1000, 1/1500, 1/2000
29.97p mode	1/48, 1/50, 1/60, 1/96, 1/100, 1/120, 1/125, 1/250, 1/500, 1/1000, 1/1500, 1/2000
23.98p mode	1/48, 1/50, 1/60, 1/96, 1/100, 1/120, 1/125, 1/250, 1/500, 1/1000, 1/1500, 1/2000
50p/50i mode	1/60, 1/100, 1/125, 1/250, 1/500, 1/1000, 1/1500, 1/2000
25p mode	1/48, 1/50, 1/60, 1/96, 1/100, 1/125, 1/250, 1/500, 1/1000, 1/1500, 1/2000
119.88p mode	1/125, 1/250, 1/500, 1/1000, 1/1500, 1/2000
100p mode	1/125, 1/250, 1/500, 1/1000, 1/1500, 1/2000

### SYNCHRO SCAN

This is used to adjust the shutter speed in the mode which was selected as the [SHUTTER MODE] setting.

When a higher shutter speed is selected, fast-moving subjects do not become blurred easily but the images will be darker.

The shutter speeds that can be set are listed below.

	When [SYNCHRO] is selected as the [SHUTTER MODE]
60p/59.94p/59.94i mode	60.0 Hz to 7200 Hz
29.97p mode	30.0 Hz to 7200 Hz
23.98p mode	24.0 Hz to 7200 Hz
50p/50i mode	50.0 Hz to 7200 Hz
25p mode	25.0 Hz to 7200 Hz
119.88p mode	120.1 Hz to 7200 Hz
100p mode	100.1 Hz to 7200 Hz

### PEDESTAL

#### <NOTE>

- For all of the PEDESTAL items, setting is not possible when [V-LOG] is [ON] and [V-LOG PAINT SW] is [OFF].

#### MASTER PEDESTAL [-200 to +200]

This item is used to adjust the black level (adjust the pedestal).

These parts become darker when a negative setting is selected and, conversely, lighter when a positive setting is selected.

#### R PEDESTAL [-800 to +800]

This enables the R pedestal to be adjusted.

#### G PEDESTAL [-800 to +800]

This enables the G pedestal to be adjusted.

#### B PEDESTAL [-800 to +800]

This enables the B pedestal to be adjusted.

#### PEDESTAL OFFSET [OFF, ON]

Set the pedestal level of the Rch, Gch, and Bch when the auto black balance has been adjusted.

OFF	Set the pedestal level to [0] for [R PEDESTAL], [G PEDESTAL], and [B PEDESTAL].
ON	Maintain the values set for each of [R PEDESTAL], [G PEDESTAL], and [B PEDESTAL].

### CHROMA

#### <NOTE>

- For all of the CHROMA items, setting is not possible when [V-LOG] is [ON] and [V-LOG PAINT SW] is [OFF].

#### CHROMA LEVEL SW [OFF, ON]

Set ON/OFF for the chroma level control.

#### CHROMA LEVEL [-100% to 40%]

Set here the color intensity (chroma level) of the images.

### COLOR TEMP SETTING

#### <NOTE>

- For all of the COLOR TEMP SETTING items, setting is not possible when [V-LOG] is [ON] and [V-LOG PAINT SW] is [OFF].

#### COLOR TEMP ACH/BCH

Set the color temperature and gain when the [WHITE BALANCE MODE] is [AWB A] or [AWB B].

#### COLOR TEMP ACH [2000K to 15000K]

Set the color temperature when [WHITE BALANCE MODE] is [AWB A].

#### R GAIN ACH [-400 to +400]

This enables adjustments to R Gain when [WHITE BALANCE MODE] is [AWB A].

#### B GAIN ACH [-400 to +400]

This enables adjustments to B Gain when [WHITE BALANCE MODE] is [AWB A].

#### G AXIS ACH [-400 to +400]

You can adjust the gain in the G-Mg direction when the [WHITE BALANCE MODE] is [AWB A].

#### COLOR TEMP BCH [2000K to 15000K]

Set the color temperature when [WHITE BALANCE MODE] is [AWB B].

#### R GAIN BCH [-400 to +400]

This enables adjustments to R Gain when [WHITE BALANCE MODE] is [AWB B].

#### B GAIN BCH [-400 to +400]

This enables adjustments to B Gain when [WHITE BALANCE MODE] is [AWB B].

#### G AXIS BCH [-400 to +400]

You can adjust the gain in the G-Mg direction when the [WHITE BALANCE MODE] is [AWB B].

### RGB GAIN CONTROL SETTING

#### <NOTE>

- For all of the RGB GAIN CONTROL SETTING items, setting is not possible when [V-LOG] is [ON] and [V-LOG PAINT SW] is [OFF].

#### G GAIN REL CONTROL SW [OFF, ON]

Set ON/OFF for the relative value control of the G gain.

#### RGB GAIN PRESET

Set the gain when the [WHITE BALANCE MODE] is [3200K], [5600K], or [VAR].

#### R GAIN [-1000 to +1000]

This enables the R gain to be adjusted.

#### G GAIN [-1000 to +1000]

This enables the G gain to be adjusted.

#### B GAIN [-1000 to +1000]

This enables the B gain to be adjusted.

#### RGB GAIN ACH/BCH

Set the gain when the [WHITE BALANCE MODE] is [AWB A] or [AWB B].

#### R GAIN ACH [-1000 to +1000]

You can adjust the R gain when the [WHITE BALANCE MODE] is [AWB A].

#### G GAIN ACH [-1000 to +1000]

You can adjust the G gain when the [WHITE BALANCE MODE] is [AWB A].

#### B GAIN ACH [-1000 to +1000]

You can adjust the B gain when the [WHITE BALANCE MODE] is [AWB A].

#### GAIN OFFSET ACH [OFF, ON]

When auto white balance is performed by setting [WHITE BALANCE MODE] to [AWB A], set the values for R gain and B gain.

OFF	Makes the [R GAIN ACH] and [B GAIN ACH] values [0].
ON	Leaves the values set in [R GAIN ACH] and [B GAIN ACH] as they are.

#### R GAIN BCH [-1000 to +1000]

You can adjust the R gain when the [WHITE BALANCE MODE] is [AWB B].

#### G GAIN BCH [-1000 to +1000]

You can adjust the G gain when the [WHITE BALANCE MODE] is [AWB B].

#### B GAIN BCH [-1000 to +1000]

You can adjust the B gain when the [WHITE BALANCE MODE] is [AWB B].

#### GAIN OFFSET BCH [OFF, ON]

When auto white balance is performed by setting [WHITE BALANCE MODE] to [AWB B], set the values for R gain and B gain.

OFF	Makes the [R GAIN BCH] and [B GAIN BCH] values [0].
ON	Leaves the values set in [R GAIN BCH] and [B GAIN BCH] as they are.

## Camera menu items (continued)

### FLARE

#### <NOTE>

- For all of the FLARE items, setting is not possible when [V-LOG] is [ON] and [V-LOG PAINT SW] is [OFF].

#### FLARE [OFF, ON]

Set OFF/ON for flare compensation.

#### MASTER FLARE [-200 to 0 to +200]

Adjust the master flare.

#### R FLARE [-200 to 0 to +200]

Adjust the Rch flare.

#### G FLARE [-200 to 0 to +200]

Adjust the Gch flare.

#### B FLARE [-200 to 0 to +200]

Adjust the Bch flare.

### GAMMA/BLACK GAMMA

#### <NOTE>

- For all of the GAMMA/BLACK GAMMA items, setting is not possible when [V-LOG] is [ON] and [V-LOG PAINT SW] is [OFF].
- For all of the GAMMA/BLACK GAMMA items, setting is not possible when [HDR] is [ON].

#### GAMMA [OFF, ON]

Select ON/OFF for the gamma mode.

#### GAMMA MODE SELECT

##### [HD, NORMAL, CINEMA1, CINEMA2]

Select the gamma curve type.

HD	HD (High Definition) video gamma characteristic.
NORMAL	Standard gamma characteristic.
CINEMA1	High contrast gamma characteristic.
CINEMA2	Sedate gamma characteristic.

#### MASTER GAMMA [0.15 to 0.75 (0.01 step)]

Adjust the gamma correction level.

Specifying smaller values results in a gentler gamma curve for the slope of low-brightness areas and sharper contrast.

Specifying larger values results in an expanded gradient for dark areas and produces brighter images. The gamma curve for low-brightness areas will be steeper, and contrast will be softer.

#### R GAMMA [-75 to +75]

Set the gamma for the Rch.

#### B GAMMA [-75 to +75]

Set the gamma for the Bch.

#### BLACK GAMMA [OFF, ON]

Select ON/OFF for the gamma curve for dark areas.

#### MASTER BLACK GAMMA [-48 to +48]

Adjust the master black gamma correction level.

-48 to -1	Compresses dark parts.
+1 to +48	Expands dark parts.

#### R BLACK GAMMA [-20 to +20]

Make adjustments to the black gamma correction level for the Rch.

#### B BLACK GAMMA [-20 to +20]

Make adjustments to the black gamma correction level for the Bch.

### BLACK GAMMA RANGE [1 to 3]

Set the maximum level of compression/expansion for the gamma curve for dark areas.

1	About 20%
2	About 30%
3	About 40%

### INITIAL GAMMA [4.0, 4.5, 5.0]

Set the rising slope for the gamma curve.

This can only be set when [GAMMA MODE SELECT] is [HD].

### KNEE

#### <NOTE>

- For all of the KNEE items, setting is not possible when [V-LOG] is [ON] and [V-LOG PAINT SW] is [OFF].
- For all of the KNEE items, setting is not possible when [HDR] is [ON].
- When [DRS] is enabled, the knee setting is disabled.

#### KNEE [OFF, ON]

Set ON/OFF for the operating mode for gradation compression (knee).

#### KNEE MODE [AUTO, MANUAL]

Set the operating mode for gradation compression (knee).

AUTO	Automatically set the knee point and knee slope.
MANUAL	Manually set the knee point and knee slope.

#### KNEE MASTER POINT

##### [80.00% to 110.00% (0.25% step)]

Set the compression level (knee point) position for high-brightness video signals.

This is only enabled when [KNEE MODE] is set to [MANUAL].

#### KNEE R POINT [-25.00% to 25.00% (0.25% step)]

Make positional settings for the compression level (knee point) of the Rch against the [KNEE MASTER POINT].

This is only enabled when [KNEE MODE] is set to [MANUAL].

#### KNEE B POINT [-25.00% to 25.00% (0.25% step)]

Make positional settings for the compression level (knee point) of the Bch against the [KNEE MASTER POINT].

This is only enabled when [KNEE MODE] is set to [MANUAL].

#### KNEE MASTER SLOPE [00 to 199]

Set the incline of knee.

This is only enabled when [KNEE MODE] is set to [MANUAL].

#### KNEE R SLOPE [-99 to +99]

Set the incline of the Rch against the [KNEE MASTER SLOPE].

This is only enabled when [KNEE MODE] is set to [MANUAL].

#### KNEE B SLOPE [-99 to +99]

Set the incline of the Bch against the [KNEE MASTER SLOPE].

This is only enabled when [KNEE MODE] is set to [MANUAL].

#### AUTO KNEE RESPONSE [1 to 8]

Set the speed of the auto knee response.

The response speed increases the lower the setting value.

### WHITE CLIP

#### <NOTE>

- For all of the WHITE CLIP items, setting is not possible when [V-LOG] is [ON] and [V-LOG PAINT SW] is [OFF].
- For all of the WHITE CLIP items, setting is not possible when [HDR] is [ON].

#### WHITE CLIP [OFF, ON]

Turn the white clip function OFF/ON.

#### MASTER WHITE CLIP LEVEL [80% to 109%]

Set the master white clip level.

#### R WHITE CLIP LEVEL [-15% to +15%]

Set the white clip level of the Rch against the [MASTER WHITE CLIP LEVEL].

#### B WHITE CLIP LEVEL [-15% to +15%]

Set the white clip level of the Bch against the [MASTER WHITE CLIP LEVEL].

#### HI-COLOR [OFF, ON]

Set the control of the mode to expand the dynamic range of colors. This improves the color reproducibility in very bright parts.

#### HI-COLOR LEVEL [1 to 32]

Set the level of the mode to expand the dynamic range of colors.

### DRS

#### <NOTE>

- For all of the DRS items, setting is not possible when [V-LOG] is [ON] and [V-LOG PAINT SW] is [OFF].

#### DRS [OFF, ON]

Set ON/OFF for the DRS function which makes appropriate corrections when recording video that has a large light/dark contrast.

#### EFFECT DEPTH [1 to 5]

Set the effect level of the DRS function. The effect level increases as the number increases.



### DETAIL SETTING

#### <NOTE>

- For all of the DETAIL SETTING items, setting is not possible when [V-LOG] is [ON] and [V-LOG PAINT SW] is [OFF].

#### DETAIL [OFF, ON]

Turn ON/OFF the contour (sharpness of images) adjustment of images.

#### MASTER DETAIL [-31 to +31]

Adjust the contour correction level (master).

This is only enabled when [DETAIL] is set to [ON].

#### PEAK FREQUENCY [1 to 8]

Set the boost frequency of detail.

This is only enabled when [DETAIL] is set to [ON].

#### CRISP [00 to 63]

Set the level of noise reduction for the detail signal.

This is only enabled when [DETAIL] is set to [ON].

#### DETAIL GAIN(+) [-31 to +31]

Set the detail level of the plus direction (direction to be made brighter).

This is only enabled when [DETAIL] is set to [ON].

#### DETAIL GAIN(-) [-31 to +31]

Set the detail level of the minus direction (direction to be made darker).

This is only enabled when [DETAIL] is set to [ON].

#### DETAIL CLIP(+) [00 to 63]

Set the level of clipping of the detail signal in the plus direction (brighter direction).

This is only enabled when [DETAIL] is set to [ON].

#### DETAIL CLIP(-) [00 to 63]

Set the level of clipping of the detail signal in the minus direction (darker direction).

This is only enabled when [DETAIL] is set to [ON].

#### KNEE APERTURE LEVEL [00 to 39]

Adjust the level of detail for very bright parts.

This is only enabled when [DETAIL] is set to [ON].

#### DETAIL KNEE [00 to 15]

Adjust the detail component of knee.

This is only enabled when [DETAIL] is set to [ON].

#### LEVEL DEPENDENT SW [OFF, ON]

Set ON/OFF for the level of reduction in detail in dark parts.

This is only enabled when [DETAIL] is set to [ON].

#### LEVEL DEPENDENT [00 to 15]

Set the level of reduction in detail in dark parts.

This is only enabled when [DETAIL] is set to [ON].

#### DARK DETAIL SW [OFF, ON]

Set ON/OFF for the control that adds detail in dark parts.

This is only enabled when [DETAIL] is set to [ON].

#### DARK DETAIL [0 to 7]

Set the level of detail in dark parts.

This is only enabled when [DETAIL] is set to [ON].

### DOWNCON SETTING

Adjust the contours and colors of images down-converted from 4K to HD.

This is enabled when [FORMAT] is one of the following:  
2160/59.94p, 2160/29.97p, 2160/23.98p, 2160/24p, 2160/50p, 2160/25p

#### <NOTE>

- For all of the DOWNCON SETTING items, setting is not possible when [V-LOG] is [ON] and [V-LOG PAINT SW] is [OFF].

### CHROMA

#### CHROMA LEVEL SW [OFF, ON]

Set ON/OFF for the chroma level control.

#### CHROMA LEVEL [-100% to 40%]

Set here the color intensity (chroma level) of the images.

### DETAIL SETTING

#### DETAIL [OFF, ON]

Turn ON/OFF the contour (sharpness of images) adjustment of images.

#### MASTER DETAIL [-31 to +31]

Adjust the contour correction level (master).

This is only enabled when [DETAIL] is set to [ON].

#### H DETAIL LEVEL [00 to 63]

Adjust the level of detail horizontally.

This is only enabled when [DETAIL] is set to [ON].

#### V DETAIL LEVEL [00 to 63]

Make adjustments vertically to the contour correction level.

This is only enabled when [DETAIL] is set to [ON].

#### PEAK FREQUENCY [12.4MHz to 37.1MHz]

Set the boost frequency of detail.

This is only enabled when [DETAIL] is set to [ON].

#### V DETAIL FREQUENCY [00 to 31]

Set the boost frequency of detail (vertically).

00: Low frequency

to

31: High frequency

When a high frequency is selected, the detail effect is added to subjects with more definition.

This is only enabled when [DETAIL] is set to [ON].

#### CRISP [00 to 63]

Set the level of noise reduction for the detail signal.

This is only enabled when [DETAIL] is set to [ON].

#### DETAIL CLIP(+) [00 to 63]

Set the level of clipping of the detail signal in the plus direction (brighter direction).

This is only enabled when [DETAIL] is set to [ON].

#### DETAIL CLIP(-) [00 to 63]

Set the level of clipping of the detail signal in the minus direction (darker direction).

This is only enabled when [DETAIL] is set to [ON].

#### KNEE APERTURE LEVEL [00 to 39]

Adjust the level of detail for very bright parts.

This is only enabled when [DETAIL] is set to [ON].



### DETAIL KNEE [00 to 15]

Adjust the detail component of knee.

This is only enabled when [DETAIL] is set to [ON].

### LEVEL DEPENDENT SW [OFF, ON]

Set ON/OFF for the control that reduces detail in dark parts.

This is only enabled when [DETAIL] is set to [ON].

### LEVEL DEPENDENT [00 to 15]

Set the level of reduction in detail in dark parts.

This is only enabled when [DETAIL] is set to [ON].

### DARK DETAIL SW [OFF, ON]

Set ON/OFF for the control that adds detail in dark parts.

This is only enabled when [DETAIL] is set to [ON].

### DARK DETAIL [0 to 7]

Set the level of detail in dark parts.

This is only enabled when [DETAIL] is set to [ON].

## SKIN TONE DETAIL SETTING

### <NOTE>

- For all of the SKIN TONE DETAIL SETTING items, setting is not possible when [V-LOG] is [ON] and [V-LOG PAINT SW] is [OFF].

### SKIN TONE DETAIL [OFF, ON]

This function smooths skin and produces a more beautiful image.

Set ON/OFF for the skin tone detail function.

### MEMORY SELECT [A, B, C]

Select the skin tone table of the subject for the skin tone effect.

### ZEBRA [OFF, ON]

Set ON/OFF for the zebra display of the skin tone area.

The zebra pattern is displayed only on devices connected to the 3G SDI OUT2/PM connector.

### <NOTE>

- This cannot be set when [ZEBRA] in [SKIN TONE DETAIL SETTING] is [ON].

### ZEBRA EFFECT MEMORY

[A, B, C, A+B, A+C, B+C, A+B+C]

Select the skin tone table for the zebra display.

### SKIN TONE EFFECT MEMORY

[A, B, C, A+B, A+C, B+C, A+B+C]

Select the skin tone table for the skin tone effect.

### SKIN TONE CRISP [0 to 8]

Adjust the skin tone detail.

### I CENTER [000 to 255]

Set the central position above the I axis (area where skin tone is to take effect).

### I WIDTH [000 to 255]

Set the width of the area where the skin tone is to take effect above the I axis, centered on [I CENTER].

### Q WIDTH [000 to 127]

Set the width of the area where the skin tone is to take effect above the Q axis, centered on [I CENTER].

### Q PHASE [0 to 359]

Set the phase of the area where skin tone is to take effect based on the Q axis.

## SKIN TONE DETAIL SETTING

### <NOTE>

- For all of the SKIN TONE DETAIL SETTING items, setting is not possible when [V-LOG] is [ON] and [V-LOG PAINT SW] is [OFF].

### SKIN TONE DETAIL [OFF, ON]

This function smooths skin and produces a more beautiful image.

Set ON/OFF for the skin tone detail function.

### MEMORY SELECT [A, B, C]

Select the skin tone table of the subject for the skin tone effect.

### ZEBRA [OFF, ON]

Set ON/OFF for the zebra display of the skin tone area.

The zebra pattern is displayed only on devices connected to the 3G SDI OUT2/PM connector.

### <NOTE>

- This cannot be set when [ZEBRA] in [DOWNCON SETTING] is [ON].

### ZEBRA EFFECT MEMORY

[A, B, C, A+B, A+C, B+C, A+B+C]

Select the skin tone table for the zebra display.

### SKIN TONE EFFECT MEMORY

[A, B, C, A+B, A+C, B+C, A+B+C]

Select the skin tone table for the skin tone effect.

### SKIN TONE CRISP [-63 to 0 to +63]

Adjust the skin tone detail.

### I CENTER [000 to 255]

Set the central position above the I axis (area where skin tone is to take effect).

### I WIDTH [000 to 255]

Set the width of the area where the skin tone is to take effect above the I axis, centered on [I CENTER].

### Q WIDTH [000 to 255]

Set the width of the area where the skin tone is to take effect above the Q axis, centered on [I CENTER].

### Q PHASE [0 to 359]

Set the phase of the area where skin tone is to take effect based on the Q axis.

## Camera menu items (continued)

### LINEAR MATRIX

#### <NOTE>

- For all of the LINEAR MATRIX items, setting is not possible when [V-LOG] is [ON] and [V-LOG PAINT SW] is [OFF].

#### PRESET MATRIX

[HD, NORMAL, CINEMA1, CINEMA2, USER]

Select the type of matrix.

HD	Matrix setting conforming to Panasonic broadcasting devices.
NORMAL	Standard matrix setting.
CINEMA1	High contrast matrix setting.
CINEMA2	Sedate matrix setting.
USER	Matrix setting conforming to Panasonic remote camera AW-UE150. Use this setting to match color reproducibility with AW-UE150.

#### MATRIX [OFF, ON]

Set ON/OFF for the matrix (linear matrix/color correction).

#### LINEAR MATRIX [OFF, ON]

Set ON/OFF for the linear matrix function.

#### LINEAR TABLE [A, B]

Select the table for the linear matrix.

#### COLOR CORRECT [OFF, ON]

Set ON/OFF for the color correction function.

#### COLOR CORRECT TABLE [A, B]

Select the table for color correction.

#### MATRIX (R-G)\_N [-31 to +31]

Make adjustments to the linear matrix. Set N direction of R-G.

#### MATRIX (R-G)\_P [-31 to +31]

Make adjustments to the linear matrix. Set P direction of R-G.

#### MATRIX (R-B)\_N [-31 to +31]

Make adjustments to the linear matrix. Set N direction of R-B.

#### MATRIX (R-B)\_P [-31 to +31]

Make adjustments to the linear matrix. Set P direction of R-B.

#### MATRIX (G-R)\_N [-31 to +31]

Make adjustments to the linear matrix. Set N direction of G-R.

#### MATRIX (G-R)\_P [-31 to +31]

Make adjustments to the linear matrix. Set P direction of G-R.

#### MATRIX (G-B)\_N [-31 to +31]

Make adjustments to the linear matrix. Set N direction of G-B.

#### MATRIX (G-B)\_P [-31 to +31]

Make adjustments to the linear matrix. Set P direction of G-B.

#### MATRIX (B-R)\_N [-31 to +31]

Make adjustments to the linear matrix. Set N direction of B-R.

#### MATRIX (B-R)\_P [-31 to +31]

Make adjustments to the linear matrix. Set P direction of B-R.

#### MATRIX (B-G)\_N [-31 to +31]

Make adjustments to the linear matrix. Set N direction of B-G.

#### MATRIX (B-G)\_P [-31 to +31]

Make adjustments to the linear matrix. Set P direction of B-G.

### COLOR CORRECTION

Make adjustments to the color saturation and hue.

#### <NOTE>

- For all of the COLOR CORRECTION items, setting is not possible when [V-LOG] is [ON] and [V-LOG PAINT SW] is [OFF].

#### PRESET MATRIX

[HD, NORMAL, CINEMA1, CINEMA2, USER]

Select the type of matrix.

HD	Matrix setting conforming to Panasonic broadcasting devices.
NORMAL	Standard matrix setting.
CINEMA1	High contrast matrix setting.
CINEMA2	Sedate matrix setting.
USER	Matrix setting conforming to Panasonic remote camera AW-UE150. Use this setting to match color reproducibility with AW-UE150.

#### MATRIX [OFF, ON]

Set ON/OFF for the matrix (linear matrix/color correction).

#### LINEAR MATRIX [OFF, ON]

Set ON/OFF for the linear matrix function.

#### LINEAR TABLE [A, B]

Select the table for the linear matrix.

#### COLOR CORRECT [OFF, ON]

Set ON/OFF for the color correction function.

#### COLOR CORRECT TABLE [A, B]

Select the table for color correction.

#### G SAT [-127 to 0 to +126]

Adjust the color saturation. Set the color in the green direction.

#### G PHASE [-127 to 0 to +126]

Adjust the hue. Set the color in the green direction.

#### G\_CY SAT [-127 to 0 to +126]

Adjust the color saturation. Set the color between green and cyan.

#### G\_CY PHASE [-127 to 0 to +126]

Adjust the hue. Set the color between green and cyan.

#### CY SAT [-127 to 0 to +126]

Adjust the color saturation. Set the color in the cyan direction.

#### CY PHASE [-127 to 0 to +126]

Adjust the hue. Set the color in the cyan direction.

## Camera menu items (continued)

### **CY\_B SAT [-127 to 0 to +126]**

Adjust the color saturation. Set the color between cyan and blue.

### **CY\_B PHASE [-127 to 0 to +126]**

Adjust the hue. Set the color between cyan and blue.

### **B SAT [-127 to 0 to +126]**

Adjust the color saturation. Set the color in the blue direction.

### **B PHASE [-127 to 0 to +126]**

Adjust the hue. Set the color in the blue direction.

### **B\_MG SAT [-127 to 0 to +126]**

Adjust the color saturation. Set the color between blue and magenta.

### **B\_MG PHASE [-127 to 0 to +126]**

Adjust the hue. Set the color between blue and magenta.

### **MG\_SAT [-127 to 0 to +126]**

Adjust the color saturation. Set the color in the magenta direction.

### **MG\_PHASE [-127 to 0 to +126]**

Adjust the hue. Set the color in the magenta direction.

### **MG\_R SAT [-127 to 0 to +126]**

Adjust the color saturation. Set the color between magenta and red.

### **MG\_R PHASE [-127 to 0 to +126]**

Adjust the hue. Set the color between magenta and red.

### **R SAT [-127 to 0 to +126]**

Adjust the color saturation. Set the color in the red direction.

### **R PHASE [-127 to 0 to +126]**

Adjust the hue. Set the color in the red direction.

### **R\_YE SAT [-127 to 0 to +126]**

Adjust the color saturation. Set the color between red and yellow.

### **R\_YE PHASE [-127 to 0 to +126]**

Adjust the hue. Set the color between red and yellow.

### **YE SAT [-127 to 0 to +126]**

Adjust the color saturation. Set the color in the yellow direction.

### **YE PHASE [-127 to 0 to +126]**

Adjust the hue. Set the color in the yellow direction.

### **YE\_G SAT [-127 to 0 to +126]**

Adjust the color saturation. Set the color between yellow and green.

### **YE\_G PHASE [-127 to 0 to +126]**

Adjust the hue. Set the color between yellow and green.

## **DNR**

Set the digital noise reduction level for outputting bright, clear images without noise, even at night and low-light conditions. Noise can be reduced by increasing the value.

However, image lag may increase.

### **<NOTE>**

- For all of the DNR items, setting is not possible when [V-LOG] is [ON] and [V-LOG PAINT SW] is [OFF].

### **DNR [OFF, ON]**

Set ON/OFF for the digital noise reduction function.

### **DNR LEVEL [1 to 5]**

Set the digital noise reduction level.

## **V-LOG PAINT**

Set the color temperature and noise reduction during V-LOG.

### **<NOTE>**

- This is enabled only when [V-LOG PAINT SW] is [OFF].

## **COLOR TEMP SETTING**

### **COLOR TEMP ACH/BCH**

Set the color temperature and gain when the [WHITE BALANCE MODE] is [AWB A] or [AWB B].

### **COLOR TEMP ACH [2000K to 15000K]**

This displays the color temperature when [WHITE BALANCE MODE] is [AWB A].

### **R GAIN ACH [-400 to +400]**

This enables adjustments to R Gain when [WHITE BALANCE MODE] is [AWB A].

### **B GAIN ACH [-400 to +400]**

This enables adjustments to B Gain when [WHITE BALANCE MODE] is [AWB A].

### **G AXIS ACH [-400 to +400]**

Adjust the gain in the G-Mg direction when the [WHITE BALANCE MODE] is [AWB A].

### **COLOR TEMP BCH [2000K to 15000K]**

This displays the color temperature when [WHITE BALANCE MODE] is [AWB B].

### **R GAIN BCH [-400 to +400]**

This enables adjustments to R Gain when [WHITE BALANCE MODE] is [AWB B].

### **B GAIN BCH [-400 to +400]**

This enables adjustments to B Gain when [WHITE BALANCE MODE] is [AWB B].

### **G AXIS BCH [-400 to +400]**

Adjust the gain in the G-Mg direction when the [WHITE BALANCE MODE] is [AWB B].

## **DNR**

Set the digital noise reduction level for outputting bright, clear images without noise, even at night and low-light conditions. Noise can be reduced by increasing the value.

However, image lag may increase.

### **DNR [OFF, ON]**

Set ON/OFF for the digital noise reduction function.

### **DNR LEVEL [1 to 5]**

Set the digital noise reduction level.

## Camera menu items (continued)

### HDR PAINT

Set the image quality for HDR.

#### <NOTE>

- This is enabled only when [HDR] is [ON].
- This is disabled when [V-LOG] is [ON].

### HLG MODE [FIX, VAR]

Select the HLG setting mode.

FIX	Fixed mode
VAR	Variable mode

### SDR CONVERT MODE [FIX, VAR]

Select the mode for converting to SDR.

FIX	Fixed mode
VAR	Variable mode

### GAMMA/BLACK GAMMA

The setting is disabled when [FIX] is selected in [HLG MODE] and it cannot be set.

#### BLACK GAMMA [OFF, ON]

Set ON/OFF for black gamma.

#### MASTER BLACK GAMMA [-32 to +32]

Adjust the master black gamma correction level.

#### R BLACK GAMMA [-32 to +32]

Make adjustments to the black gamma correction level for the Rch.

#### B BLACK GAMMA [-32 to +32]

Make adjustments to the black gamma correction level for the Bch.

### KNEE

The setting is disabled when [FIX] is selected in [HLG MODE] and it cannot be set.

#### KNEE [OFF, ON]

Set ON/OFF for knee.

#### KNEE POINT [60.00 to 100.00 (0.25% step)]

Set the knee point position.

#### KNEE SLOPE [0 to 199]

Set the incline of knee.

### SDR CONVERT

The setting is disabled when [FIX] is selected in [SDR CONVERT MODE] and it cannot be set.

#### GAIN

[0dB, -5dB, -6dB, -7dB, -8dB, -9dB, -10dB, -11dB, -12dB]

Set the gain of SDR images.

#### POINT [0 to 100]

Set the image level to start SDR image compression.

#### SLOPE [0 to 127]

Set the incline for compression of SDR images.

#### BLACK OFFSET [-100 to +100]

Adjust the black level offset of SDR images.

### PAINT SWITCH

#### FLARE [OFF, ON]

Set OFF/ON for flare compensation.

#### GAMMA [OFF, ON]

Select ON/OFF for the gamma mode.

#### BLACK GAMMA [OFF, ON]

Set ON/OFF for the gamma curve for dark areas.

#### KNEE [OFF, ON]

Set ON/OFF for the operating mode for gradation compression (knee).

#### WHITE CLIP [OFF, ON]

Set ON/OFF for the white clip function.

#### DRS [OFF, ON]

Set ON/OFF for the DRS function which makes appropriate corrections when recording video that has a large light/dark contrast.

#### DETAIL [OFF, ON]

Set ON/OFF for image contour (image sharpness) adjustments.

#### SKIN TONE DETAIL [OFF, ON]

Set ON/OFF for the skin tone detail function.

#### MATRIX [OFF, ON]

Set ON/OFF for the matrix (linear matrix/color correction).

#### LINEAR MATRIX [OFF, ON]

Set ON/OFF for the linear matrix function.

#### COLOR CORRECT [OFF, ON]

Set ON/OFF for the color correction function.

## Camera menu items (continued)

### LENS

#### FOCUS MODE [MANUAL, AUTO]

Select manual/auto for the focus adjustment function.

MANUAL	Adjust focus manually.
AUTO	Always adjust focus automatically.

#### AF SENSITIVITY [NORMAL, STABLE]

Select the conformability mode for auto focusing function.

NORMAL	Focusing is with a standard conformability.
STABLE	Focusing is with a priority placed on stability.

#### ZOOM MODE [Opt.ZOOM, i.ZOOM, D.ZOOM]

Set the maximum magnification rate for zoom.

Opt.ZOOM	Use only optical zoom. Optical zoom up to 20× is possible.
i.ZOOM	Enable the i.Zoom function. When this function is enabled, digital zoom is used while reducing image degradation. <b>When [BASIC CONFIG] – [FORMAT] is 2160/59.94p, 2160/29.97p, 2160/50p, 2160/25p, 2160/24p, 2160/23.98p</b> Up to 24× zoom is possible combining optical zoom and digital zoom. • When [BASIC CONFIG] – [FORMAT] is other than one of these, up to 32× zoom is possible combining optical zoom and digital zoom.
D.ZOOM	Enable the digital zoom function. Higher digital zoom magnifications will result in coarser images.

#### MAX DIGITAL ZOOM

[×2, ×3, ×4, ×5, ×6, ×7, ×8, ×9, ×10]

Set the maximum digital zoom magnification.

This is only enabled when [ZOOM MODE] is set to [D.ZOOM].

<NOTE>

- Higher digital zoom magnifications will result in coarser images.

#### DIGITAL EXTENDER [OFF, ×1.4, ×2.0]

Make settings for the digital extender function.

OFF	Turn the digital extender function OFF.
×1.4	The digital zoom will be fixed at 1.4×.
×2.0	The digital zoom will be fixed at 2.0×.

This is only enabled when [ZOOM MODE] is set to [Opt.ZOOM].

#### O.I.S. [OFF, ON]

Set OFF/ON for the optical image stabilization (O.I.S.) function.

#### O.I.S. MODE

##### [O.I.S.(STABLE), O.I.S.(PAN/TILT), HYBRID(STABLE), HYBLID(PAN/TILT)]

Sets the mode for optical image stabilization (O.I.S.) and roll direction electronic image stabilization (E.I.S.).

O.I.S. (STABLE)	Turns the optical image stabilization (O.I.S.) function ON. Use with a pan/tilt fixed shooting scene.
O.I.S. (PAN/TILT)	Turns the optical image stabilization (O.I.S.) function ON. Use with a scene for increasing the image stabilization effect during a shooting while performing the pan/tilt operation.
HYBRID (STABLE)	Turns the optical image stabilization (O.I.S.) function and roll direction electronic image stabilization (E.I.S.) function ON. Use with a pan/tilt fixed shooting scene.
HYBRID (PAN/TILT)	Turns the optical image stabilization (O.I.S.) function and roll direction electronic image stabilization (E.I.S.) function ON. Use with a scene for increasing the image stabilization effect during a shooting while performing the pan/tilt operation.

<NOTE>

- In [O.I.S.(STABLE)] or [HYBRID(STABLE)] mode, the optical image stabilization (O.I.S.) function's level of correction is reduced during pan/tilt operations in order to minimize the convergence resulting from image stabilization during pan/tilt operations.
- In [O.I.S.(PAN/TILT)] or [HYBRID(PAN/TILT)] mode, as importance is given to heighten the image stabilization effect during pan/tilt operations, the convergence resulting from image stabilization during pan/tilt control may be a cause for concern in some scenes. Use [O.I.S.(STABLE)] or [HYBRID(STABLE)] for scenes where the convergence resulting from image stabilization needs to be restrained.

#### ND FILTER [THROUGH, 1/4, 1/16, 1/64]

Set the transmittance of the lens' built-in ND (neutral density) filter.

The filter switches when the setting is fixed.

THROUGH	Do not set ND filter.
1/4	Set ND filter transmittance to 1/4.
1/16	Set ND filter transmittance to 1/16.
1/64	Set ND filter transmittance to 1/64.

<NOTE>

- This is enabled only when [PAINT] – [GAIN SETTING] – [DAY/ NIGHT] is [DAY].

**MONITOR DISPLAY**

**WFM**

**MODE [OFF, ON(Y), ON(Y/Pb/Pr)]**

Switch the WaveForm display setting.

OFF	WaveForm not displayed.
ON(Y)	Waveform of Y component only displayed.
ON(Y/Pb/Pr)	Waveform of Y, Pb, and Pr components each displayed.

**POSITION [UR, BR, BL, UL]**

Select the area for displaying the WaveForm.

UR	Display WaveForm in the top right area.
BR	Display WaveForm in the bottom right area.
BL	Display WaveForm in the bottom left area.
UL	Display WaveForm in the top left area.

(Example)

WaveForm display when [MODE] is [ON(Y/Pb/Pr)] and [BR] is selected for [POSITION] (The displayed image is for reference.)

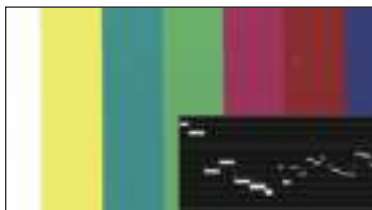

**<NOTE>**

- The WaveForm is displayed only on devices connected to the 3G SDI OUT2/PM connector, and is not displayed on devices connected to the connectors of other output systems.

**STATUS INDICATOR**

For items that have been set to [ON], when the designated status is reached and where [CHAR] is [ON], the statuses are displayed in the images of connectors where [OUTPUT ITEM] is set to [STATUS].

**RETURN SELECT [OFF, ON]**

When [ON], the character string set in [RETURN] – [RETURN1 ID] is displayed as OSD in the region at the top center of the screen.

The RETURN SELECT character string is displayed only on devices connected to the 3G SDI OUT2/PM connector.

(Example)

RETURN SELECT (displayed constantly)

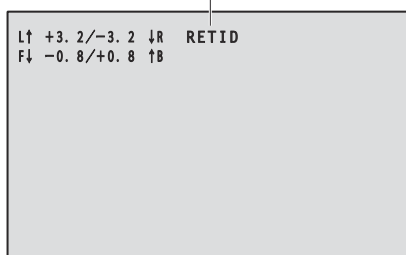

**STATUS(AUTO) [OFF, ON]**

When [ON], the following status indications are displayed on the OSD:

- Display of the results after auto white balance is run
- Display of the results after auto black balance is run
- Error display when an error occurs

(Example)

**STATUS(AUTO)**

(Displayed for 5 seconds only under certain conditions)

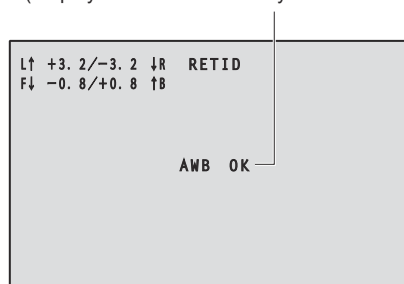

**LEVEL GAUGE [OFF, ON]**

When [ON], the status of the incline (horizontally, to the left or right or front and back) of the unit installation is displayed as OSD in the top left of the screen.

(Example)

LEVEL GAUGE (displayed constantly)

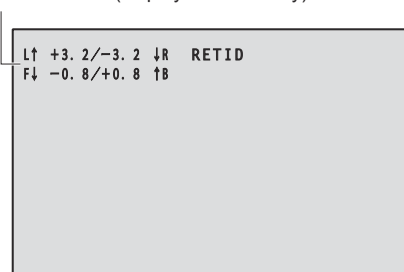

In the case of the display above, the unit is installed at an inclination of 3.2° upward to the left and 1.8° upward in to the front. The maximum incline is ±9.9°, and when there is an incline of 10° or greater, the display shows “±9.9”.

**<NOTE>**

- LEVEL GAUGE is displayed only through SDI, HDMI, and SMPTE ST2110. It is not displayed with High bandwidth NDI and IP transmission (H.264/H.265/M-JPEG).
- The LEVEL GAUGE value is not updated during PAN/TILT operation.

### TRACKING DATA OUTPUT

Make settings related to the output of tracking data used in virtual studio systems, etc. (→ page 71)

#### <NOTE>

- There is no tracking data output when [BASIC CONFIG] – [FORMAT] is [1080/119.88p] or [1080/100p].

#### SERIAL [OFF, ON]

Set ON/OFF for the function which outputs the tracking data such as Pan/Tilt/Zoom data via the serial output (RS-422) and synchronizes it with the GENLOCK signal. (→ page 71)

#### <NOTE>

- The camera control commands are not output from the RS-422 connector when [SERIAL] is [ON].

#### IP [OFF, ON]

Set ON/OFF for the function which outputs with UDP the tracking data such as Pan/Tilt/Zoom data via IP output and synchronizes it with the GENLOCK signal. (→ page 72)

#### <NOTE>

- When [IP] is [ON], video transmission via IP may be delayed or the video may suffer frame loss.  
We recommend setting [IP] to [OFF] to avoid the delay or frame loss due to the video transmission via IP.

#### INVERT PAN/TILT AXIS [OFF, ON]

Set whether to invert the PAN/TILT data for output in the tracking data.

OFF	PAN/TILT data is not inverted.
ON	PAN/TILT data is inverted for output.

#### CAMERA ID [0x00 to 0xFF]

Sets the Camera ID for tracking data.

### Tracking data output

When [SERIAL] or [IP] of [TRACKING DATA OUTPUT] is set to [ON], outputs the tracking data for Pan/Tilt/Zoom or other information to link with a virtual studio system or elsewhere via serial (RS-422) or IP output.

#### Serial (RS-422) output

- When [SERIAL] of [TRACKING DATA OUTPUT] is set to [ON], the tracking data for Pan/Tilt/Zoom or other information is synchronized with the GENLOCK signal and output via the serial output (RS-422).
- The tracking data is output in stream mode in a format conforming to the free-d protocol. The message type is Type D1 (camera position/orientation data) only.

#### Advanced stored data

This unit stores and outputs the following data according to the packet structure specified in Type D1 of the free-d protocol.

##### Camera ID

An ID between 00h and FFh can be selected.

##### Camera Pan Angle

Stores the Pan angle of the unit (–175° to +175°) with the format provided by the free-d protocol.

##### Camera Tilt Angle

Stores the Tilt angle of the unit (–30° to +210°) with the format provided by the free-d protocol.

#### <NOTE>

- The range of the angle is limited to between –90° and +90° in the free-d protocol. However, this unit can store greater angles than +90° (up to +210°).

##### Camera Roll Angle

Stores the rotation angle (0° or 180°) corresponding to the FLIP state (turned upside down or left-right reversed) of the unit with the format provided by the free-d protocol.

Stores an angle of 180° in the flipped state (turned upside down or left-right reversed) (exceeding the angle specified when [SMART PICTURE FLIP] is [ON]), and stores 0° other than in this condition.

##### Camera X-Position

Always stores 000000h.

##### Camera Y-Position

Always stores 000000h.

##### Camera Height (Z-Position)

Always stores 000000h.

##### Camera Zoom

Stores the magnification of optical zoom of this unit between 000555h (WIDE) and 000FFFh (TELE).

#### <NOTE>

- The magnification of digital zoom is not stored.



## Camera menu items (continued)

### Camera Focus

Stores the value of focus position of this unit between 000555h (NEAR) and 000FFFh (FAR).

### Spare / User Defined (16bit)

Stores the value of iris position of this unit between 0555h (CLOSE) and 0FFFh (OPEN).

### Checksum

Stores the checksum value provided by the free-d protocol.

### <NOTE>

- The camera control commands are not output from the RS-422 connector when [SERIAL] is [ON].

### ● IP output

- When [IP] of [TRACKING DATA OUTPUT] is set to [ON], the tracking data for Pan/Tilt/Zoom or other information is synchronized with the GENLOCK signal and outputs UDP packets via IP.
- Outputs simultaneously up to four clients (IP addresses) that have been specified on the designated web screen (→ page 165).
- The tracking data is output in a format conforming to the free-d protocol. The output specification (mode, command type, advanced stored data) of this unit is equivalent to serial (RS-422) output.

### <NOTE>

- When forwarding to more than one client, the timing of transmitting the UDP packet to the second and subsequent client will always be delayed relative to the GENLOCK signal.  
(Approximately 200 to 300 μs delay will occur for each client. The latency may be increased depending on the system status or the network environment of the unit.)
- When [IP] is [ON], video transmission via IP may be delayed or the video may suffer frame loss.  
We recommend setting [IP] to [OFF] to avoid the delay or frame loss due to the video transmission via IP.

## CROP

### UHD CROP [OFF, CROP(1080), CROP(720)]

Make overall CROP mode settings.

OFF	No cropping.
CROP(1080)	Cropped images output with 1080 resolution.
CROP(720)	Cropped images output with 720 resolution.

### <NOTE>

- Only when [2160/59.94p] or [2160/50p] is selected in [BASIC CONFIG] – [FORMAT] are [OFF], [CROP(1080)], and [CROP(720)] available for selection, and when [2160/60p], [2160/29.97p], [2160/25p], [2160/24p], or [2160/23.98p] is selected, [OFF] and [CROP(1080)] only may be selected.  
When other selections are made in FORMAT, this will be [OFF].

### CROP ZOOM [OFF, ON]

Make settings about whether to run cropping that uses D-ZOOM. When [ON], you can set the ZOOM magnification.

(→ "CROP ZOOM RATIO")

This is only enabled when [UHD CROP] is set to [CROP(1080)] or [CROP(720)].

### CROP AF [OFF, ON]

Make settings about whether to run AF on images within the crop frame.

This is only enabled when [UHD CROP] is set to [CROP(1080)] or [CROP(720)].

### 3G SDI OUT [FULL, CROP]

Make the settings for FULL/CROP for images output to the 3G SDI OUT connector.

FULL	FHD down-converted images are output as is without cropping UHD images.
CROP	Images with FHD cropped from UHD images are output. The images output in this case are those with the crop frame specified in [CROP OUT].

This is only enabled when [UHD CROP] is set to [CROP(1080)] or [CROP(720)].

### NDI OUT [FULL, CROP]

Makes the settings for FULL/CROP for images output to High bandwidth NDI transmission.

FULL	FHD down-converted images are output as is without cropping UHD images.
CROP	Images with FHD cropped from UHD images are output. The images output in this case are those with the crop frame specified in [CROP OUT].

This is only enabled when [UHD CROP] is set to [CROP(1080)] or [CROP(720)].



## Camera menu items (continued)

### IP(H.264/H.265) OUT1 [FULL, CROP]

### IP(H.264/H.265) OUT2 [FULL, CROP]

Make the FULL/CROP settings for images output via H.264/H.265/M-JPEG transmission (LAN connector).

The settings specified with [IP(H.264/H.265) OUT1] are applied to transmitted images from each of the CH1 transmissions (H.264(1), H.265(1), JPEG(1)).

The settings specified with [IP(H.264/H.265) OUT2] are applied to transmitted images from each of the CH2 and CH3 transmissions (H.264(2) and (3), H.265(2) and (3), JPEG(2) and (3)).

FULL	FHD down-converted images are output as is without cropping UHD images.
CROP	Images with FHD cropped from UHD images are output. The images output in this case are those with the crop frame specified in [CROP OUT].

This is only enabled when [UHD CROP] is set to [CROP(1080)] or [CROP(720)].

When the [Streaming mode] on the web screen is [NDI|HX V2], [IP(H.264/H.265) OUT1] and [IP(H.264/H.265) OUT2] will have a linked operation.

### CROP MARKER [OFF, YL, G, MG, YL+G, YL+MG, G+MG, YL+G+MG]

Make the settings for the crop frame displayed for images output to the 3G SDI OUT1 connector, the 3G SDI OUT2/PM connector, the MONITOR images of SMPTE ST2110, and the LAN connector (H.264/H.265/M-JPEG).

OFF	Crop frame not displayed.
YL	Displays only the yellow crop frame.
G	Displays only the green crop frame.
MG	Displays only the magenta crop frame.
YL+G	Displays the yellow crop frame and the green crop frame.
YL+MG	Displays the yellow crop frame and the magenta crop frame.
G+MG	Displays the green crop frame and the magenta crop frame.
YL+G+MG	Displays the yellow crop frame, the green crop frame, and the magenta crop frame.

This is only enabled when [UHD CROP] is set to [CROP(1080)] or [CROP(720)].

#### <NOTE>

- Crop frames cannot be displayed via the 12G SDI OUT/SFP+ connector or HDMI connector, or with SMPTE ST2110 MAIN images and SMPTE ST2110 CROP images.

### CROP OUT [YL, G, MG]

Make the settings for the crop frame images output to the 3G SDI OUT1 connector, cropped images of SMPTE ST2110, High bandwidth NDI images, and the LAN connector (H.264/H.265/M-JPEG).

YL	Outputs the yellow crop frame images.
G	Outputs the green crop frame images.
MG	Outputs the magenta crop frame images.

This is only enabled when [UHD CROP] is set to [CROP(1080)] or [CROP(720)].

#### <NOTE>

- The color frame specified in [CROP OUT] will be a deeper shade when compared to other colors used for frames.
- Cropped images cannot be output with the 12G SDI OUT/SFP+ connector, 3G SDI OUT2/PM connector, HDMI connector, SMPTE ST2110 MAIN images, or SMPTE ST2110 MONITOR images.

### CROP ADJUST [YL, G, MG]

Make selections for the crop frame to adjust positioning.

YL	Make adjustments to the position of the yellow crop frame.
G	Make adjustments to the position of the green crop frame.
MG	Make adjustments to the position of the magenta crop frame.

This is only enabled when [UHD CROP] is set to [CROP(1080)] or [CROP(720)].

#### <NOTE>

- The frame of the color specified in [CROP ADJUST] will be a thicker frame compared to the frames of other colors.

### CROP H POSITION [0 to 3072]

Make settings for the position in the horizontal direction for the crop frame specified in [CROP ADJUST].

The variable range is 0 to 1920 when [UHD CROP] is [CROP(1080)] and [CROP ZOOM] is [OFF], with 0 as the left edge and 1920 as the right edge, and only even numbers can be set.

The variable range is 0 to 2560 when [UHD CROP] is [CROP(720)] and [CROP ZOOM] is [OFF], with 0 as the left edge and 2560 as the right edge, and only even numbers can be set.

The variable range when [CROP ZOOM] is [ON] is different depending on the setting value of [CROP ZOOM RATIO], with the variable range being 0 to 3072 when the [CROP ZOOM RATIO] is 500.00%, and only even numbers can be set.

This is only enabled when [UHD CROP] is set to [CROP(1080)] or [CROP(720)].

### CROP V POSITION [0 to 1728]

Make settings for the position in the vertical direction for the crop frame specified in [CROP ADJUST].

The variable range is 0 to 1080 when [UHD CROP] is [CROP(1080)] and [CROP ZOOM] is [OFF], with 0 as the upper edge and 1080 as the lower edge.

The variable range is 0 to 1440 when [UHD CROP] is [CROP(720)] and [CROP ZOOM] is [OFF], with 0 as the upper edge and 1440 as the lower edge.

The variable range when [CROP ZOOM] is [ON] is different depending on the setting value of [CROP ZOOM RATIO], with the variable range being 0 to 1728 when the [CROP ZOOM RATIO] is 500.00%.

This is only enabled when [UHD CROP] is set to [CROP(1080)] or [CROP(720)].

### CROP ZOOM RATIO [120.00% to 500.00%]

Specifies the size of the CROP frame when [CROP ZOOM] is [ON]. The crop zoom ratio can be specified between the range of 120.00% to 500.00%, and the grain-size can be set in units of 10.00% from the OSD menu.

The variable range of the setting value of this item, the CROP frame size, [CROP H POSITION] and [CROP V POSITION] is below.

CROP ZOOM RATIO	CROP frame size	Variable range	
		CROP H POSITION	CROP V POSITION
120.00%	3200×1800	0 to 640	0 to 360
⋮	⋮	⋮	⋮
200.00%	1920×1080	0 to 1920	0 to 1080
⋮	⋮	⋮	⋮
300.00%	1280×720	0 to 2560	0 to 1440
⋮	⋮	⋮	⋮
400.00%	960×540	0 to 2880	0 to 1620
⋮	⋮	⋮	⋮
500.00%	768×432	0 to 3072	0 to 1728

This is only enabled when [UHD CROP] is set to [CROP(1080)] or [CROP(720)].

This is only enabled when [CROP ZOOM] is set to [ON].

### The CROP function

If [UHD CROP] is set to [CROP(1080)] or [CROP(720)], images cropped from the UHD signal can be output via the 3G SDI OUT1 connector, the CROP images of SMPTE ST2110, High bandwidth NDI images, and the LAN connector (H.264/H.265/M-JPEG). (Image 2)

When this happens, uncropped UHD image video signals that are down-converted to FHD are output to other connectors that do not have cropped images, with crop frames displayed according to the menu settings in [CROP MARKER]. (Image 1)

Crop frame

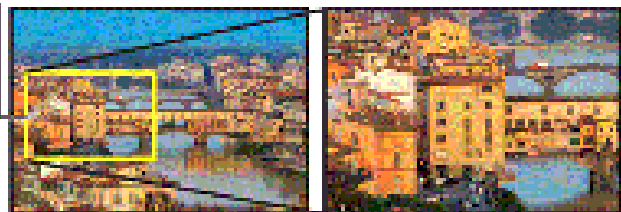

Image 1

Image 2

Depending on the [3G SDI1 OUT], [NDI OUT], [IP(H.264/H.265) OUT1], [IP(H.264/H.265) OUT2] and [CROP OUT] settings, images output from the 3G SDI OUT and LAN connectors will be as shown below.

3G SDI1 OUT / NDI OUT / IP(H.264/H.265) OUT1 / IP(H.264/H.265) OUT2	CROP OUT	Images output from 3G SDI OUT and LAN connectors
FULL	-	UHD images down-converted to FHD
CROP	YL	Images cropped with the yellow frame
	G	Images cropped with the green frame
	MG	Images cropped with the magenta frame

**<NOTE>**

- Cropped images cannot be output with the 12G SDI OUT/SFP+ connector, 3G SDI OUT2/PM connector, HDMI connector, SMPTE ST2110 MAIN images, or SMPTE ST2110 MONITOR images.



Depending on the [CROP MARKER] settings, it is possible to select the crop frame to output to the 3G SDI OUT1 connector, 3G SDI OUT2/PM connector, MONITOR images of SMPTE ST2110, and the IP (H.264/H.265/M-JPEG) connector, with a connector that is not outputting cropped images.

CROP MARKER	Crop frame display
OFF	Crop frame is not displayed.
YL	Only a yellow crop frame is displayed.
G	Only a green crop frame is displayed.
MG	Only a magenta crop frame is displayed.
YL+G	Yellow and green crop frames are displayed.
YL+MG	Yellow and magenta crop frames are displayed.
G+MG	Green and magenta crop frames are displayed.
YL+G+MG	Yellow, green, and magenta crop frames are displayed.

**<NOTE>**

- When moving the CROP frame (YL/G/MG), there may be some jerking of the CROP frame display, but there will be no jerking in the actual CROP output images.
- Crop frames cannot be displayed via the 12G SDI OUT/SFP+ connector or HDMI connector, or with SMPTE ST2110 MAIN images and SMPTE ST2110 CROP images.

### PAN/TILT

#### INSTALL POSITION [DESKTOP, HANGING]

[DESKTOP] or [HANGING] is selected here as the method used to install the unit.

DESKTOP	Stand-alone installation
HANGING	Suspended installation

**<NOTE>**

- When [HANGING] has been selected, the top, bottom, left and right of the images will be reversed, and up/down/left/right control for panning and tilting will also be reversed.

#### SMART PICTURE FLIP [OFF, AUTO]

When the tilt becomes the angle set for [FLIP DETECT ANGLE], the image will be flipped in the vertical direction automatically.

OFF	The picture is not turned upside down.
AUTO	The picture is automatically turned upside down.

#### FLIP DETECT ANGLE [60deg, 120deg]

Set the tilt angle at which the image will be flipped in the vertical direction automatically when [SMART PICTURE FLIP] is set to [AUTO].

#### P/T SPEED MODE

##### [NORMAL(60deg/s), FAST1(90deg/s), FAST2(180deg/s)]

Set the speed of PAN/TILT operation.

NORMAL(60deg/s)	PAN/TILT operates at normal speed (maximum about 60° per second).
FAST1(90deg/s)	PAN/TILT operates at fast speed1 (maximum about 90° per second).
FAST2(180deg/s)	PAN/TILT operates at fast speed2 (maximum about 180° per second).

#### P/T ACCELERATION SETTING

Displays the advanced setting screen for setting the acceleration speed while starting/stopping a pan/tilt operation.

##### P/T ACCELERATION [MANUAL, AUTO]

Sets whether to perform advance setting for acceleration and deceleration etc. during manual operation of pan/tilt.

MANUAL	Sets the advanced settings for acceleration speed etc. during start/stop or changing the speed of pan/tilt operation.
AUTO	Sets the settings for automatic acceleration and deceleration speed etc. during start/stop or changing the speed of pan/tilt operations.

#### RISE S-CURVE [0 to 30]

Sets the S-curve for pan/tilt acceleration operation in 31 steps. (The greater the number, the steeper the S-curve)

When it is necessary to increase the speed to the specified speed using manual control of pan/tilt by lever operation etc. through the controller, the acceleration process is performed based on the S-curve specified in this setting.

This is enabled only when [P/T ACCELERATION] is [MANUAL].

**<NOTE>**

- In order to limit the acceleration response, in the S-curve step, as the acceleration speed rises, the limit is automatically applied.

## Camera menu items (continued)

### FALL S-CURVE [0 to 30]

Sets the S-curve for pan/tilt deceleration operation in 31 steps. (The greater the number, the steeper the S-curve)

When it is necessary to reduce the speed to the specified speed using manual control of pan/tilt by lever operation etc. through the controller, the deceleration process is performed based on the S-curve specified in this setting.

This is enabled only when [P/T ACCELERATION] is [MANUAL].

#### <NOTE>

- In order to limit the deceleration response, in the S-curve step, as the deceleration speed rises, the limit is automatically applied.
- For the relationships between the various setting values in [P/T ACCELERATION SETTING], refer to the diagram on page 76.

### RISE ACCELERATION [1 to 255]

Sets the acceleration speed for pan/tilt acceleration operation in 255 steps. (The acceleration speed increases as the number increases)

When it is necessary to increase the speed to the specified speed using manual control of pan/tilt by lever operation etc. through the controller, the acceleration process is performed based on the acceleration speed specified in this setting.

This is enabled only when [P/T ACCELERATION] is [MANUAL].

#### <NOTE>

- When the specified acceleration speed is small, it is not possible to reach the maximum speed of the product.

### FALL ACCELERATION [1 to 255]

Sets the deceleration speed for pan/tilt deceleration operation in 255 steps. (The deceleration speed increases as the number increases)

When it is necessary to reduce the speed to the specified speed using manual control of pan/tilt by lever operation etc. through the controller, the deceleration process is performed based on the deceleration speed specified in this setting.

This is enabled only when [P/T ACCELERATION] is [MANUAL].

#### <NOTE>

- The deceleration and stop processes are carried out right up to the end of the lens mechanism section and in order to prevent a collision with the mechanism, in the actual operation, [FALL ACCELERATION] may be restricted.

### SPEED WITH ZOOM POSITION [OFF, ON]

[OFF] or [ON] is set here for the function used to adjust the pan/tilt adjustment speed in conjunction with the zoom magnification.

When [ON] is set, the panning and tilting operations will become slower in the zoom status.

This function has no effect during preset operations.

### FOCUS ADJUST WITH PTZ. [OFF, ON]

[OFF] or [ON] is set here for the function which compensates for out-of-focusing when it occurs during panning, tilting or zooming operations.

When [OFF] is set, adjust the focus as required after zooming or set [FOCUS MODE] to [AUTO].

This is only enabled when [MANUAL] has been selected as the [FOCUS MODE] setting.

### PRIVACY MODE [OFF, ON]

Sets OFF/ON the function for turning the camera direction down when this unit is changed to STANDBY mode.

OFF	Does not change the camera direction when the camera is switched to STANDBY mode. (The camera direction from the POWER ON state is maintained.)
ON	Moves the camera to face toward the rear when the camera is switched to STANDBY mode. When the unit switches again to the POWER ON state, the unit moves to the position according to [POWER ON POSITION].

### POWER ON POSITION

#### [NONE, STANDBY, HOME, PRESET]

Select the initial positions for PAN/TILT/ZOOM when the power is turned on.

NONE	Maintains the PAN/TILT position when the power is turned on, and ZOOM will be at the Wide end.
STANDBY	Move to the PAN/TILT/ZOOM positions they were in the last time the camera was switched to STANDBY mode.
HOME	PAN/TILT move to their home positions (front) and ZOOM goes to the Wide end.
PRESET	Preset playback is performed at the preset position specified with [PRESET NUMBER].

### PRESET NUMBER [001 to 100]

Specify a number for preset playback when the power turns ON when [PRESET] is set in [POWER ON POSITION].

#### <NOTE>

- If an unregistered preset number is set, preset playback is not performed and the operation is the same as [STANDBY].

■ The relationships between the various setting values during manual operation of pan/tilt when [P/T ACCELERATION] is set to [MANUAL]

It is possible to specify the responsiveness (maximum speed, acceleration rate, S-curve steps) for operation.

<NOTE>

- When the specified acceleration speed is small, it is not possible to reach the maximum speed of the product.

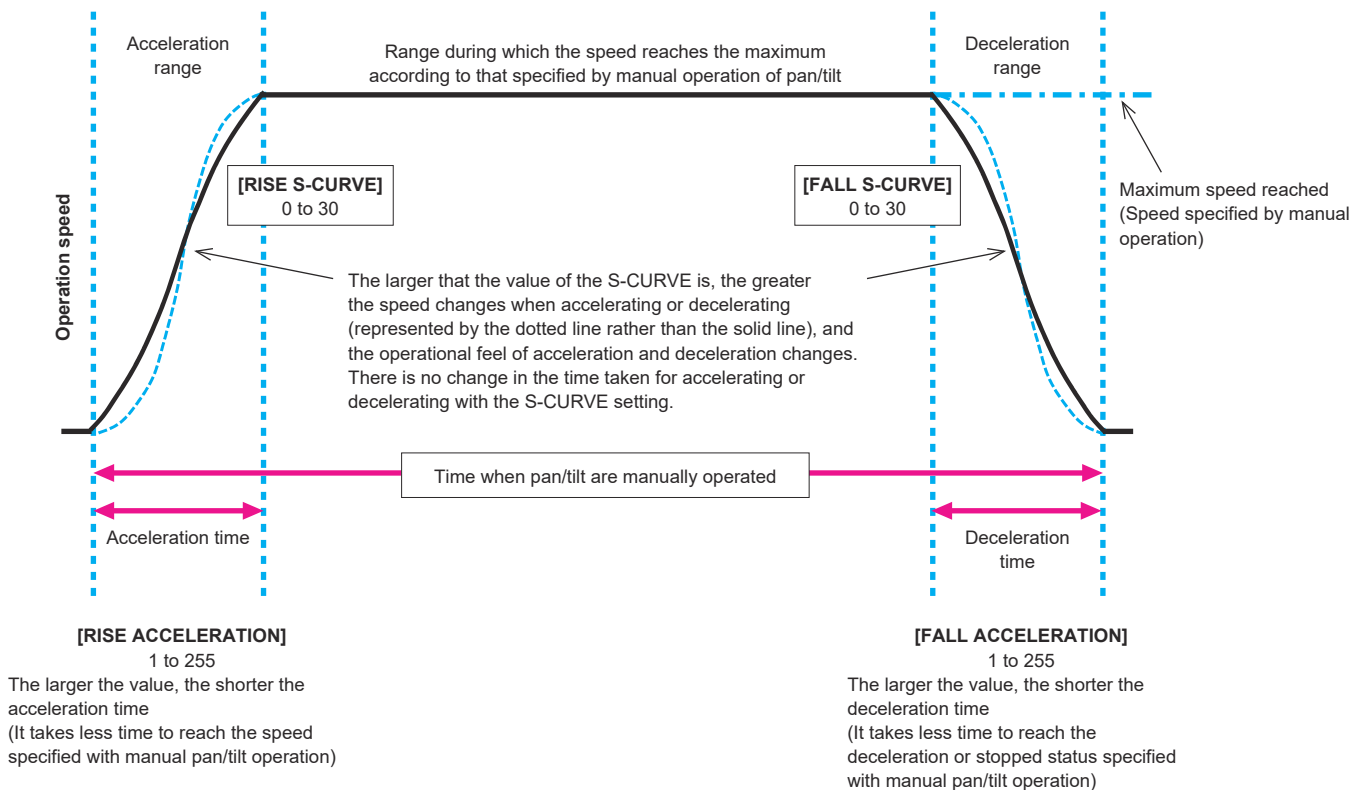

**PRESET**

**PRESET SPEED UNIT [SPEED TABLE, TIME]**

When reproducing the information such as camera direction registered in the preset memory, you can select whether to specify the playback time by speed or by time.

SPEED TABLE	Specify the speed when playing during preset playback.
TIME	Specify the time when playing during preset playback.

**PRESET SPEED TABLE [SLOW, FAST]**

Set the preset speed table (SLOW, FAST). During preset playback, presets are performed at [PRESET SPEED] (1 to 30) values that are based on the table set here.

This is only enabled when [PRESET SPEED UNIT] is set to [SPEED TABLE].

**PRESET SPEED [1 to 30 / 1s to 99s]**

**When [PRESET SPEED UNIT] is [SPEED TABLE]: [1 to 30]**

Set the pan/tilt operation speed in 30 steps when playing back the preset memory.

**<NOTE>**

- When you set large [PRESET SPEED] values, the image may sway when the movement stops.

**When [PRESET SPEED UNIT] is [TIME]: [1s to 99s]**

Set the pan/tilt operation time between 1 and 99 seconds when playing back the preset memory.

**<NOTE>**

- Depending on the movement distance of pan/tilt, there may be a difference compared to the specified time.

**PRESET ACCELERATION SETTING**

Displays the advanced setting screen for setting acceleration speed when starting/stopping preset playback.

**PRESET ACCELERATION [MANUAL, AUTO]**

MANUAL	Makes the advance settings for acceleration speed etc. when starting/stopping preset playback.
AUTO	Automatically operates acceleration speed etc. when starting/stopping preset playback.

**RISE S-CURVE [0 to 30]**

Sets the S-curve for pan/tilt acceleration operation in 31 steps. (The greater the number, the steeper the S-curve)

During the acceleration operation for operating at the specified speed or time during pan/tilt operations by preset playback, the acceleration process is performed using the S-curve specified in this setting.

This is enabled only when [PRESET ACCELERATION] is [MANUAL].

**<NOTE>**

- In order to limit the acceleration response, in the S-curve step, as the acceleration speed rises, the limit is automatically applied.

**FALL S-CURVE [0 to 30]**

Sets the S-curve for pan/tilt deceleration operation in 31 steps. (The greater the number, the steeper the S-curve)

During the deceleration operation for operating at the specified speed or time during pan/tilt operations by preset playback, the deceleration process is performed using the S-curve specified in this setting.

This is enabled only when [PRESET ACCELERATION] is [MANUAL].

**<NOTE>**

- In order to limit the deceleration response, in the S-curve step, as the deceleration speed rises, the limit is automatically applied.
- For the relationships between the various setting values in [PRESET ACCELERATION], refer to the diagram on page 79, 80.

**RISE ACCELERATION [1 to 255]**

Sets the acceleration speed for pan/tilt acceleration operation in 255 steps. (The acceleration speed increases as the number increases.) During the acceleration operation for operating at the specified speed or time during pan/tilt operations by preset playback, the acceleration process is performed using the acceleration speed specified in this setting.

This is enabled only when [PRESET ACCELERATION] is [MANUAL] and [PRESET SPEED UNIT] is [SPEED TABLE].

**<NOTE>**

- As the speed specified for [PRESET SPEED] is given priority as the maximum speed attained in preset playback, if the acceleration speed specified here is small, this functionality may not operate as specified.

**FALL ACCELERATION [1 to 255]**

Sets the deceleration speed for pan/tilt deceleration operation in 255 steps. (The deceleration speed increases as the number increases.)

During the deceleration operation for operating at the specified speed or time during pan/tilt operations by preset playback, the deceleration process is performed using the deceleration speed specified in this setting.

This is enabled only when [PRESET ACCELERATION] is [MANUAL] and [PRESET SPEED UNIT] is [SPEED TABLE].

**<NOTE>**

- As the speed specified for [PRESET SPEED] is given priority as the maximum speed attained in preset playback, if the deceleration speed specified here is small, this functionality may not operate as specified.

**RISE RAMP TIME [0.1s to 10.0s]**

Sets the acceleration time for the time specific operation during preset playback. (Sets between 0.1s to 10.0s in 0.1s increments)

This is enabled only when [PRESET ACCELERATION] is [MANUAL] and [PRESET SPEED UNIT] is [TIME].

**<NOTE>**

- As the time specified in [PRESET SPEED] takes precedence as the total time for preset playback, if the time specified here is more than half of the time specified in [PRESET SPEED], this functionality will not operate as specified.
- When the acceleration operation cannot be performed within the specified time even at maximum acceleration speed of the device, the operation will not be performed by the specified time.

**FALL RAMP TIME [0.1s to 10.0s]**

Sets the deceleration time for time specified operations during preset playback. (Sets between 0.1s to 10.0s in 0.1s increments)

This is enabled only when [PRESET ACCELERATION] is [MANUAL] and [PRESET SPEED UNIT] is [TIME].

**<NOTE>**

- As the time specified in [PRESET SPEED] takes precedence as the total time for preset playback, if the time specified here is more than half of the time specified in [PRESET SPEED], this functionality will not operate as specified.
- When the deceleration operation cannot be performed within the specified time even at maximum fall deceleration of the device, the operation will not be performed by the specified time.

**PRESET SCOPE [MODE A, MODE B, MODE C]**

Selected here are the setting items to be recalled when the contents of the preset memory are regenerated.

MODE A	PAN, TILT, ZOOM (including digital zoom), FOCUS, IRIS, GAIN, SHUTTER, white balance adjustment value
MODE B	PAN, TILT, ZOOM (including digital zoom), FOCUS, IRIS
MODE C	PAN, TILT, ZOOM (including digital zoom), FOCUS

## Camera menu items (continued)

### PRESET DIGITAL EXTENDER [OFF, ON]

Turns the preset digital extender function OFF/ON.

When set to [ON], the digital extender function configuration will be recalled when regenerating the preset memory.

When set to [OFF], the digital extender function configuration will not be recalled when storing the preset memory.

### PRESET CROP [OFF, ON]

When the preset memory is played back, set whether the reproduction of content set in the various [UHD CROP] menus is OFF/ON.

When set to [ON], the content set in the various [UHD CROP] menus is reproduced when preset memory is played back.

When set to [OFF], the content set in the various [UHD CROP] menus is not reproduced when preset memory is played back, with the current values being kept.

#### <NOTE>

- This is only enabled when [CROP] – [UHD CROP] is set to [CROP(1080)] or [CROP(720)].
- When [CROP] – [UHD CROP] is [OFF] or [CROP(1080)] and preset memory is registered and preset playback is executed when [UHD CROP] is [CROP(720)], then, even if [PRESET CROP] is [ON], the content set in each menu of [UHD CROP] is not recalled.
- When [CROP] – [UHD CROP] is [CROP(720)] and preset memory is registered and preset playback is executed when [UHD CROP] is [CROP(1080)], then, even if [PRESET CROP] is [ON], the content set in each menu of [UHD CROP] is not recalled.

### PRESET THUMBNAIL UPDATE [OFF, ON]

Turn OFF/ON the function for registering the still image (thumbnail) for the images being output when a preset memory is registered.

When set to [ON], the still image (thumbnail) for the images being output is registered when registering a preset memory.

When set to [OFF], the still image (thumbnail) for the images being output is not registered when registering a preset memory, but rather the still image (thumbnail) previously registered is maintained.

#### <NOTE>

- When [IP SIGNAL] – [IP(H.264/H.265)] – [CHAR] is [ON], the character strings of OSD menu displayed during the generation of still images (thumbnails) and CROP frames are imported to the thumbnails.
- When [CROP] – [UHD CROP] is [CROP(1080)] or [CROP(720)], the still image for the images (FULL or CROP) specified in [CROP] – [IP(H.264/H.265) OUT1] is registered.
- Still images (thumbnails) registered in the preset memory are deleted when user files are uploaded with a web screen, etc. (→ page 189)
- When continuous registration of preset memories is performed (continuous registration within 3 seconds), still images (thumbnails) for the second preset memory on may not be registered, with black still images (thumbnails) being used instead.

### PRESET NAME [RESET, HOLD]

When registering a preset memory, set whether to reset the previously registered preset name or keep it.

RESET	When registering a preset memory, reset the previously registered preset name. The preset name after resetting will be [PRESET***]. (*** is a 3 digit preset number: 001 to 100)
HOLD	When registering a preset memory, keep the previously registered preset name.

#### <NOTE>

- The factory default setting for the preset name is [PRESET\*\*\*].  
(\*\*\* is a 3 digit preset number: 001 to 100)
- The registration of preset names can be done in the web browser.  
0 to 9, A to Z, a to z, \_ , and space

### PRESET IRIS [OFF, ON]

When the preset memory is played back, set whether the reproduction of the values in the various menus related to IRIS is OFF/ON.

When set to [ON], the values set in the various menus below are reproduced when preset memory is played back.

- [PAINT] – [IRIS] – [AUTO IRIS]
- [PAINT] – [IRIS] – [WINDOW SELECT]
- [PAINT] – [IRIS] – [PICTURE LEVEL]
- [PAINT] – [IRIS] – [IRIS SPEED]

#### <NOTE>

- Its setting takes effect when [MODE A] or [MODE B] has been selected as the [PRESET SCOPE] setting.

### PRESET SHUTTER [OFF, ON]

When the preset memory is played back, set whether the reproduction of the SHUTTER setting value is OFF/ON.

#### <NOTE>

- Its setting takes effect when [MODE A] has been selected as the [PRESET SCOPE] setting.
- SHUTTER values are reproduced only when the frame rate when the preset memory was registered and the frame rate when playing back the preset memory match.

### PRESET ZOOM MODE [MODE A, MODE B]

Select the zoom operation for when preset memory is recalled.

MODE A	Perform smooth zoom operation to match the behavior of pan/tilt.
MODE B	Perform constant speed zoom operation to match the behavior of pan/tilt.

### FREEZE DURING PRESET [OFF, ON]

Turn the function for freezing images during preset playback OFF/ON.

When this is set to [ON], preset playback is performed with a still of the image immediately preceding the start of preset playback being output. The image freeze is released when preset playback is finished.



■ The relationships between the various setting values when [PRESET ACCELERATION] is set to [MANUAL] during preset playback

● When [PRESET SPEED UNIT] is [SPEED TABLE]

It is possible to specify the responsiveness (maximum speed, acceleration rate, S-curve steps) for operation.

<NOTE>

- When the amount of movement specified by the preset is small, there may be cases when the specified speed is not reached.
- Restrictions are automatically placed on the acceleration rate to prioritize the specified speed. (The lower limit of the acceleration rate is automatically restricted by the specified speed.)
- To enable the pan and tilt operations to occur simultaneously, the maximum speed of the axis with a smaller amount of movement is automatically restricted.

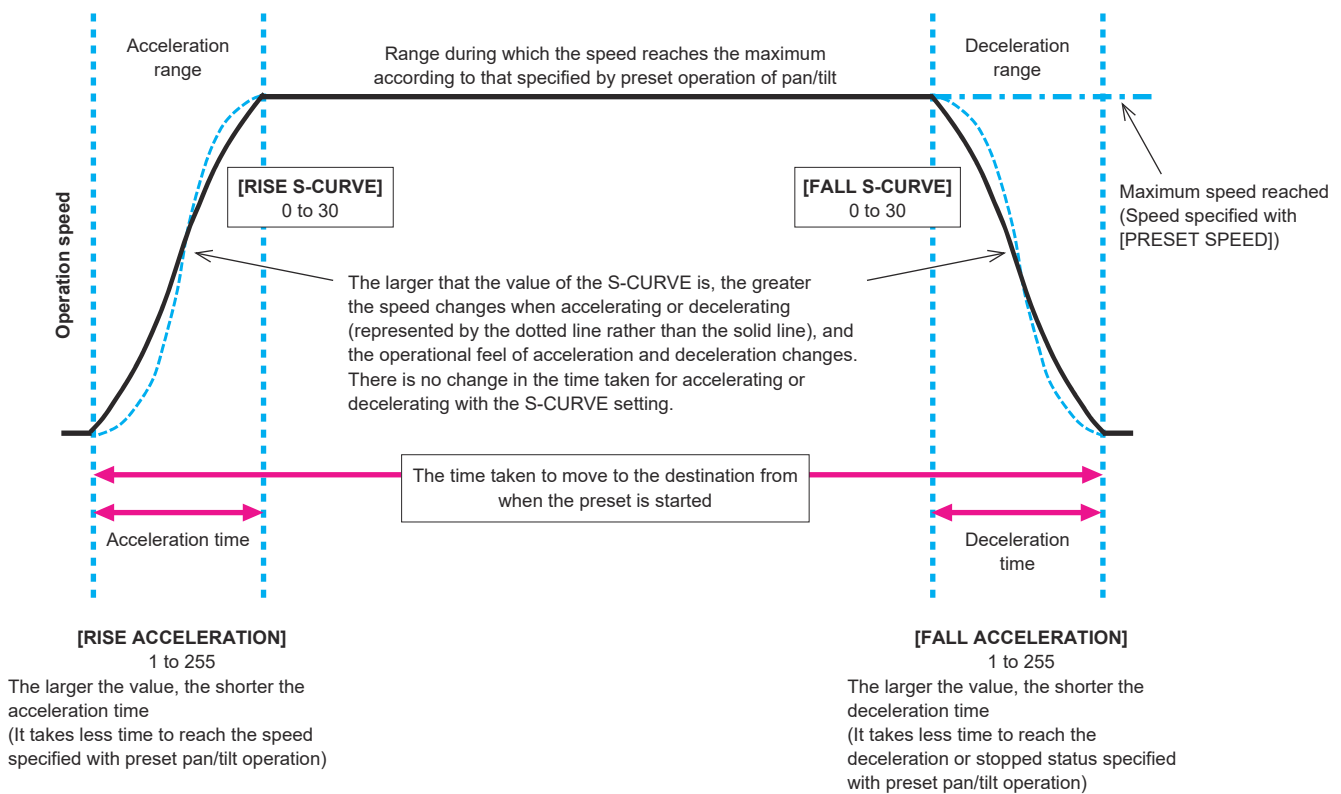

## Camera menu items (continued)

### ● When [PRESET SPEED UNIT] is [TIME]

It is possible to specify the times (time taken to move, time taken to accelerate, time taken to decelerate) and the S-curve steps for operation.

#### <NOTE>

- When the acceleration operation cannot be performed within the specified time even at maximum acceleration speed of the device, the operation will not be performed by the specified time.
- As the time specified in [PRESET SPEED] takes precedence as the total time for preset playback, if the times specified in [RISE RAMP TIME] and [FALL RAMP TIME] are more than half of the time specified in [PRESET SPEED], this will not operate as specified.

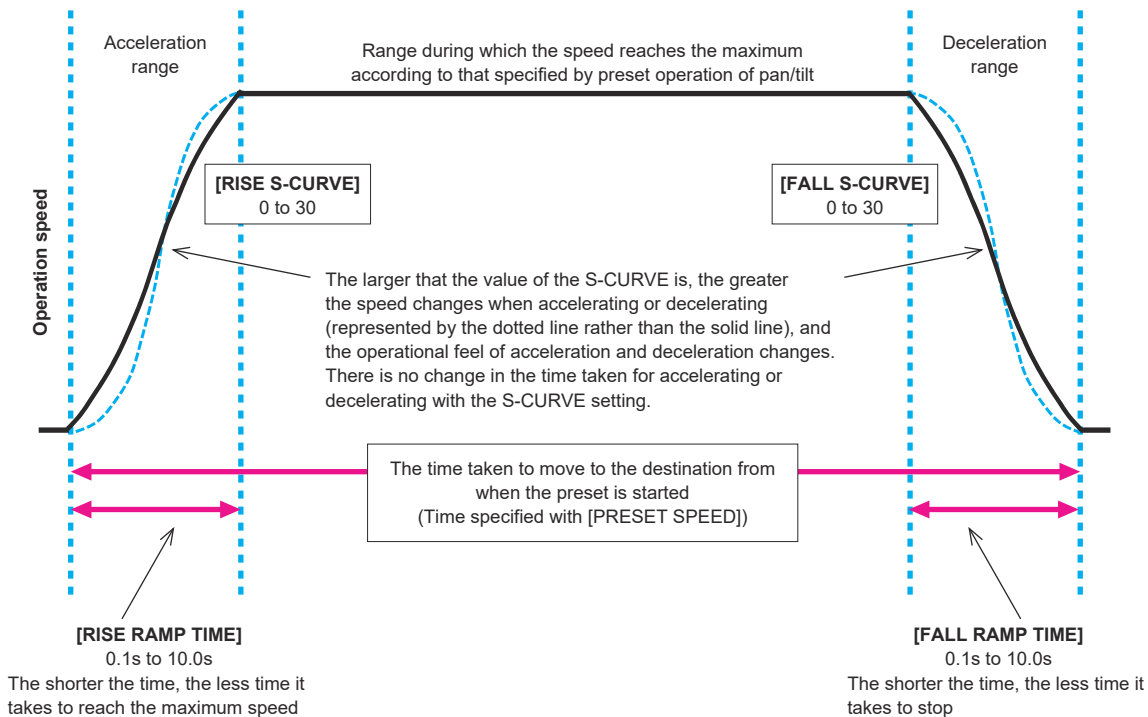



**FILES**

**SCENE FILE**

**MODE [LOAD, STORE]**

Select the operating mode for SCENE files.

LOAD	The setting values of the specified SCENE file number are applied to the images currently being output.
STORE	The setting values of the images currently being output are applied to the specified SCENE file number.

**FILE NO [OFF, 1 to 8]**

Set the SCENE file number to do LOAD/STORE.

[OFF] can be set only when [MODE] is [LOAD].

**FILE NAME**

A file name of up to 15 characters can be set for the SCENE file.  
(Alphanumeric characters, spaces, ! # % & ' ( ) \* + , - . / : ; < = > ? [ ] \_ ~ \$ @ )

**LIST**

The file names set for the SCENE files are shown in a list.  
Up to 3 can be shown in the list at a time, and then the list can be scrolled.

**EXECUTE [NO, YES]**

Execute with the set content.

**USER FILE**

**MODE [LOAD, STORE]**

Select the operating mode for USER files.

LOAD	The setting values of the specified USER file number are applied to the images currently being output.
STORE	The setting values of the images currently being output are applied to the specified USER file number.

**FILE NO [1, 2, 3]**

Set the USER file number to do LOAD/STORE.

**FILE NAME**

A file name of up to 15 characters can be set for the USER file.  
(Alphanumeric characters, spaces, ! # % & ' ( ) \* + , - . / : ; < = > ? [ ] \_ ~ \$ @ )

**LIST**

The file names set for the USER files are shown in a list.

**EXECUTE [NO, YES]**

Execute with the set content.

**MAINTENANCE**

**FAN SETTING**

**FAN1 [AUTO, LOW, MID, HIGH]**

Set the behavior of cooling fan 1 (on the LENS unit side).

**FAN2 [AUTO, LOW, MID, HIGH]**

Set the behavior of cooling fan 2 (on the base unit side).

AUTO	Enable automatic control of the cooling fan.
LOW	Operate the cooling fan at low speed.
MID	Operate the cooling fan at medium speed.
HIGH	Operate the cooling fan at high speed.

**<NOTE>**

- Even if this is set to [LOW], [MID], or [HIGH], the cooling fan may be forcibly stopped when the temperature is low.
- Even if this is set to [LOW] or [MID], the cooling fan may be forcibly operated at [HIGH] when the temperature is high.

**DATE/TIME**

Set the date and time.

**PRESENT**

Display the current time.

**DATE YY [23 to 99]**

Display the "Year" of the date.

**DATE MM [01 to 12]**

Display the "Month" of the date.

**DATE DD [1 to 31]**

Display the "Day" of the date.

**TIME HH [00 to 23]**

Display the "Hour" of the time.

**TIME MM [00 to 59]**

Display the "Minutes" of the time.

**TIME SS [00 to 59]**

Display the "Seconds" of the time.

**SET EXECUTE [NO, YES]**

Set (save) the date and time entered above.

**RESET [NO, YES]**

Restore the date and time to the factory setting.

**INITIALIZE**

**MENU INITIALIZE [NO, YES]**

OSD menu setting values are initialized.

However, the following items are not initialized:

- [FREQUENCY], [FORMAT], and [SFP+ MODE] in [BASIC CONFIG]
- Setting items in [NETWORK]
- [FORMAT SELECT] for the output connectors in [OUTPUT]
- Setting values for SCENE files 1 to 8/USER files 1 to 3
- PRESET information (information registered for 100 items)
- Setting values related to the various NETWORK items that are available for setting from the web screen
- Setting items in [DATE/TIME]

## Camera menu items (continued)

### ALL DATA INITIALIZE [NO, YES]

OSD menu setting values are initialized, along with setting values for SCENE files 1 to 8/USER files 1 to 3.

However, the following items are not initialized:

- [FREQUENCY], [FORMAT], and [SFP+ MODE] in [BASIC CONFIG]
- Setting items in [NETWORK]
- [FORMAT SELECT] for the output connectors in [OUTPUT]
- PRESET information (information registered for 100 items)
- Setting values related to the various NETWORK items that are available for setting from the web screen
- Setting items in [DATE/TIME]

### VERSION

#### SYSTEM VERSION

Display the version for overall system of the unit.

### HOURLY METER

Display the [HOURLY METER] screen that displays the operation history.

#### OPERATION

Display the cumulative hours of operation of the unit (in hourly units).

#### FAN1

Display the cumulative hours of operation of cooling fan 1 (on the LENS unit side) (in hourly units).

#### FAN2

Display the cumulative hours of operation of cooling fan 2 (on the base unit side) (in hourly units).

### HDMI STATUS

#### CONNECT

Displays the connection status of the HDMI connector.

One of the following is displayed according to the product specifications of the device or monitor connected.

UNCONNECT	Not connected.
HDMI	Connected via HDMI.
DVI	Connected via DVI.

#### FORMAT

Displays the format of the images being output via the HDMI connector.

The same format is displayed as is specified in [OUTPUT] – [HDMI] – [FORMAT].

#### VIDEO SAMPLING

The video sampling of the images being output via the HDMI connector is displayed.

One of the following is displayed according to the menu settings and the product specifications of the device or monitor connected.

---	Displayed when [CONNECT] is other than HDMI.
RGB 8bit	Displayed when [CONNECT] is HDMI and output is RGB 8bit.
YPbPr 4:2:2/10bit	Displayed when [CONNECT] is HDMI and output is YPbPr 4:2:2/10bit.
YPbPr 4:2:0/8bit	Displayed when [CONNECT] is HDMI and output is YPbPr 4:2:0/8bit.

#### <NOTE>

- Even if the video sampling is set in [OUTPUT] – [HDMI] – [VIDEO SAMPLING], it may not be possible to output using the specified format due to the product specifications of the HDMI connected device or monitor.

This item displays the status of the video sampling actually being output.

### MONITOR

Displays the status of the device or monitor connected to the HDMI connector.

One of the following is displayed according to the product specifications of the device or monitor connected.

---	Displayed when [CONNECT] is other than HDMI.
AVAILABLE	This indicates that [CONNECT] is HDMI and the device or monitor connected supports the format output by this unit.
UNSUPPORT UHD	This indicates that [CONNECT] is HDMI and the device or monitor connected does not support the format output by this unit.
UNSUPPORT UHD 60P/50P	
UNSUPPORT UHD 60P 4:2:2	
UNSUPPORT UHD 50P 4:2:2	
UNSUPPORT UHD 60P 4:2:0	
UNSUPPORT UHD 50P 4:2:0	
UNSUPPORT HLG/2020	
UNSUPPORT HLG	This indicates that [CONNECT] is HDMI and the device or monitor connected is not supported for a reason other than those shown above.
UNSUPPORT 2020	
UNSUPPORT FORMAT	

### ERROR STATUS

Display the [ERROR STATUS] screen that displays the status of errors.

#### LENS [NO ERROR, ERROR]

This displays the error status of the LENS.

#### PAN/TILT [NO ERROR, ERROR]

This displays the error status of the PAN/TILT drive section.

#### FAN1 [NO ERROR, ERROR]

Display the error status of cooling fan 1 (on the LENS unit side).

#### FAN2 [NO ERROR, ERROR]

Display the error status of cooling fan 2 (on the base unit side).

### TEMPERATURE

#### [NO ERROR, HIGH TEMPERATURE, SENSOR ERROR]

This displays the status of temperature related errors.

HIGH TEMPERATURE	Temperature is high.
SENSOR ERROR	The temperature sensor may have malfunctioned.

### WHITE SHADING

Perform white shading correction.

Make horizontal and vertical adjustments to the sawtooth waveforms and parabola waveforms of each of the RGB channels.

#### **CORRECT [OFF, ON]**

Set ON/OFF for the white shading (sawtooth waveforms or parabola waveforms) correction.

#### **W H SAW R [-100 to 0 to +100]**

Adjust the gain of the white shading for the Rch horizontally using the sawtooth waveform.

#### **W H SAW G [-100 to 0 to +100]**

Adjust the gain of the white shading for the Gch horizontally using the sawtooth waveform.

#### **W H SAW B [-100 to 0 to +100]**

Adjust the gain of the white shading for the Bch horizontally using the sawtooth waveform.

#### **W H PARA R [-100 to 0 to +100]**

Adjust the gain of the white shading for the Rch horizontally using the parabola waveform.

#### **W H PARA G [-100 to 0 to +100]**

Adjust the gain of the white shading for the Gch horizontally using the parabola waveform.

#### **W H PARA B [-100 to 0 to +100]**

Adjust the gain of the white shading for the Bch horizontally using the parabola waveform.

#### **W V SAW R [-100 to 0 to +100]**

Adjust the gain of the white shading for the Rch vertically using the sawtooth waveform.

#### **W V SAW G [-100 to 0 to +100]**

Adjust the gain of the white shading for the Gch vertically using the sawtooth waveform.

#### **W V SAW B [-100 to 0 to +100]**

Adjust the gain of the white shading for the Bch vertically using the sawtooth waveform.

#### **W V PARA R [-100 to 0 to +100]**

Adjust the gain of the white shading for the Rch vertically using the parabola waveform.

#### **W V PARA G [-100 to 0 to +100]**

Adjust the gain of the white shading for the Gch vertically using the parabola waveform.

#### **W V PARA B [-100 to 0 to +100]**

Adjust the gain of the white shading for the Bch vertically using the parabola waveform.

### WIRELESS CONTROL

#### **WIRELESS CONTROL [ENABLE, DISABLE]**

[ENABLE] or [DISABLE] is set here for operations conducted from the wireless remote control.

#### **WIRELESS ID [CAM1, CAM2, CAM3, CAM4]**

Set the remote control ID (CAM1 to CAM4).

The [CAM1] to [CAM4] in this setting correspond to the CAMERA <1> to <4> buttons on the wireless remote control.

#### **<NOTE>**

- When the power is turned on from Standby with the wireless remote control, operations from the wireless remote control are possible irrespective of this setting value.
- This item is not reflected immediately when the setting is changed. It is reflected when the unit is set to Standby mode, and then the power is turned ON with any external device other than the wireless remote control.
- This setting is not reflected when the power is turned ON with this item set to [DISABLE]. It is reflected when the unit is set to Standby mode, and then the power is turned ON with any external device other than the wireless remote control.

### STATUS LAMP

#### **STATUS LAMP [ENABLE, DISABLE]**

[DISABLE] or [ENABLE] is set here for the status display lamp.

When you want the status display lamp to stay off while this unit is in operation, set to [DISABLE].

#### **<NOTE>**

- Even when set to [DISABLE], the status display lamp may light up when this unit is starting up, updating firmware, or trouble is occurring.

# Camera menu item table

Top Menu	Camera menu	Item	Factory setting	Selection items	SCENE FILE	USER FILE
BASIC CONFIG	FREQUENCY		59.94Hz or 50Hz	60Hz, 59.94Hz, 50Hz, 24Hz, 23.98Hz		
	FORMAT		2160/59.94p or 2160/50p	(When [FREQUENCY] is set to [60Hz]) 2160/60p, 1080/60p (When [FREQUENCY] is set to [59.94Hz]) 2160/59.94p, 2160/29.97p, 1080/119.88p, 1080/59.94p, 1080/29.97p, 720/59.94p (When [FREQUENCY] is set to [50Hz]) 2160/50p, 2160/25p, 1080/100p, 1080/50p, 1080/25p, 720/50p (When [FREQUENCY] is set to [24Hz]) 2160/24p, 1080/24p (When [FREQUENCY] is set to [23.98Hz]) 2160/23.98p, 1080/23.98p		
	SFP+ MODE		12G OUTPUT	12G OUTPUT, ST2110		
	V-LOG		OFF	OFF, ON		✓
	V-LOG PAINT SW		OFF	OFF, ON		✓
	HDR		OFF	OFF, ON		✓
	GAMUT		WIDE_G2	NORMAL, WIDE_G2		✓
	SHOOTING MODE		NORMAL	NORMAL, LOW LIGHT		✓
	SERIAL CONNECTION	BAUD RATE	9600bps	9600bps, 38400bps, 115200bps		✓
	BAR		OFF	OFF, ON		✓
		COLOR BAR TYPE	TYPE1	TYPE1, TYPE2, TYPE3, TYPE4, TYPE5		✓
		TONE	ON	OFF, ON		✓
	TALLY	TALLY	ENABLE	ENABLE, DISABLE		✓
		TALLY BRIGHTNESS	LOW	LOW, MID, HIGH		✓
		TALLY GUARD	OFF	OFF, ON		✓
		TALLY LED LIMIT				✓
		R	UNLIMIT	LIMIT, UNLIMIT		✓
		G	UNLIMIT	LIMIT, UNLIMIT		✓
		Y	UNLIMIT	LIMIT, UNLIMIT		✓
		EXTERNAL OUTPUT				
		OUTPUT1	OFF	OFF, R-TALLY, G-TALLY, Y-TALLY		✓
		OUTPUT2	OFF	OFF, R-TALLY, G-TALLY, Y-TALLY		✓
		TSL5.0				✓
	SYNC SIGNAL	INDEX NO.	1	1 to 65534		✓
		PORT	62000	1 to 65535		✓
		REF SIGNAL	BBS/TRI-LEVEL SYNC	BBS/TRI-LEVEL SYNC, PTP		✓
		GEN-LOCK				✓
	H PHASE-COARSE	0	-5 to 5		✓	
		H PHASE-FINE	0	-100 to 100		✓
	BAR ID	BAR ID	OFF	OFF, ON		✓
		BRIGHTNESS	100%	0 to 100%		✓
		ID1 POSITION V	0	0 to 5		✓
		ID1 POSITION H	0	0 to 15		✓
		ID1	(spaces)	Maximum 16 characters (Alphanumeric characters, spaces, ! # % & ' ( ) * + , - . / : ; < = > ? [ ] _ ~ \$ @  )		✓
		ID2 POSITION V	1	0 to 5		✓
		ID2 POSITION H	0	0 to 15		✓
		ID2	(spaces)	Maximum 16 characters (Alphanumeric characters, spaces, ! # % & ' ( ) * + , - . / : ; < = > ? [ ] _ ~ \$ @  )		✓
		OFFSET V	0	0 to 89		✓
		OFFSET H	0	0 to 79		✓

## Camera menu item table (continued)

Top Menu	Camera menu	Item	Factory setting	Selection items	SCENE FILE	USER FILE
NETWORK	LAN	DHCP	OFF	OFF, ON		
		IP ADDRESS	192.168.0.10	<ul style="list-style-type: none"> <li>• First octet: 0 to 223 (127 cannot be set)</li> <li>• Second octet: 0 to 255</li> <li>• Third octet: 0 to 255</li> <li>• Fourth octet: 0 to 255</li> </ul>		
		SUBNET MASK	255.255.255.0	<ul style="list-style-type: none"> <li>• First octet: 128, 192, 224, 240, 248, 252, 254, 255</li> <li>• Second octet: 0, 128, 192, 224, 240, 248, 252, 254, 255</li> <li>• Third octet: 0, 128, 192, 224, 240, 248, 252, 254, 255</li> <li>• Fourth octet: 0, 128, 192, 224, 240, 248, 252, 254, 255</li> </ul>		
		DEFAULT GATEWAY	192.168.0.1	<ul style="list-style-type: none"> <li>• First octet: 0 to 223 (127 cannot be set)</li> <li>• Second octet: 0 to 255</li> <li>• Third octet: 0 to 255</li> <li>• Fourth octet: 0 to 255</li> </ul>		
		MAC ADDRESS		Display only		
	SFP+	DHCP	OFF	OFF, ON		
		IP ADDRESS	192.168.1.10	<ul style="list-style-type: none"> <li>• First octet: 0 to 223 (127 cannot be set)</li> <li>• Second octet: 0 to 255</li> <li>• Third octet: 0 to 255</li> <li>• Fourth octet: 0 to 255</li> </ul>		
		SUBNET MASK	255.255.255.0	<ul style="list-style-type: none"> <li>• First octet: 128, 192, 224, 240, 248, 252, 254, 255</li> <li>• Second octet: 0, 128, 192, 224, 240, 248, 252, 254, 255</li> <li>• Third octet: 0, 128, 192, 224, 240, 248, 252, 254, 255</li> <li>• Fourth octet: 0, 128, 192, 224, 240, 248, 252, 254, 255</li> </ul>		
		DEFAULT GATEWAY	192.168.1.1	<ul style="list-style-type: none"> <li>• First octet: 0 to 223 (127 cannot be set)</li> <li>• Second octet: 0 to 255</li> <li>• Third octet: 0 to 255</li> <li>• Fourth octet: 0 to 255</li> </ul>		
		MAC ADDRESS		Display only		
	USB	DHCP	OFF	OFF, ON		
		IP ADDRESS	192.168.3.10	<ul style="list-style-type: none"> <li>• First octet: 0 to 223 (127 cannot be set)</li> <li>• Second octet: 0 to 255</li> <li>• Third octet: 0 to 255</li> <li>• Fourth octet: 0 to 255</li> </ul>		
		SUBNET MASK	255.255.255.0	<ul style="list-style-type: none"> <li>• First octet: 128, 192, 224, 240, 248, 252, 254, 255</li> <li>• Second octet: 0, 128, 192, 224, 240, 248, 252, 254, 255</li> <li>• Third octet: 0, 128, 192, 224, 240, 248, 252, 254, 255</li> <li>• Fourth octet: 0, 128, 192, 224, 240, 248, 252, 254, 255</li> </ul>		
		DEFAULT GATEWAY	192.168.3.1	<ul style="list-style-type: none"> <li>• First octet: 0 to 223 (127 cannot be set)</li> <li>• Second octet: 0 to 255</li> <li>• Third octet: 0 to 255</li> <li>• Fourth octet: 0 to 255</li> </ul>		
		COMMON SETTING	DNS	MANUAL	MANUAL, AUTO	
		PRIMARY		Display only		
		SECONDARY		Display only		
		DOMAIN		Display only		
		HTTP PORT	80	1 to 65535		
		HTTPS PORT	443	1 to 65535		

## Camera menu item table (continued)

Top Menu	Camera menu	Item	Factory setting	Selection items		SCENE FILE	USER FILE	
OUTPUT	12G SDI OUT/SFP+	FORMAT SELECT	2160/59.94p or 2160/50p	[System Format]	[12G SDI OUT/SFP+]			
				2160/60p	2160/60p 1080/60p			
				1080/60p	1080/60p			
				2160/59.94p	2160/59.94p 1080/59.94p*1			
				2160/29.97p	2160/29.97p 1080/29.97p			
				1080/119.88p	1080/59.94p*3			
				1080/59.94p	1080/59.94p 1080/59.94i			
				1080/29.97p	1080/29.97p			
				720/59.94p	720/59.94p			
				2160/50p	2160/50p 1080/50p*2			
				2160/25p	2160/25p 1080/25p			
				1080/100p	1080/50p*3			
				1080/50p	1080/50p 1080/50i			
				1080/25p	1080/25p			
				720/50p	720/50p			
				2160/24p	2160/24p 1080/24p			
				1080/24p	1080/24p			
				2160/23.98p	2160/23.98p 1080/23.98p			
				1080/23.98p	1080/23.98p			
			HDR OUTPUT SELECT	HDR(2020)	SDR(709), HDR(709), HDR(2020)			
			V-LOG OUTPUT SELECT	V-LOG	V-LOG, V-709			
	OUTPUT ITEM	MENU ONLY	MENU ONLY, STATUS					
	CHAR	ON	OFF, ON					
	3G SDI	LEVEL-A	LEVEL-A, LEVEL-B					

\*1 When [UHD CROP] is [CROP(720)], output is 720/59.94p.

\*2 When [UHD CROP] is [CROP(720)], output is 720/50p.

\*3 For 119.88p (or 100p), "Frame 1" is output with the frame rate cut to half (59.94p (or 50p)).

## Camera menu item table (continued)

Top Menu	Camera menu	Item	Factory setting	Selection items		SCENE FILE	USER FILE
OUTPUT	3G SDI OUT1	FORMAT SELECT	1080/59.94p or 1080/50p	[System Format]	[3G SDI OUT1]		
				2160/60p	1080/60p		
				1080/60p	1080/60p		
				2160/59.94p	1080/59.94p* <sup>1</sup> 1080/59.94i* <sup>1</sup>		
				2160/29.97p	1080/29.97p		
				1080/119.88p	1080/59.94p* <sup>1</sup>		
				1080/59.94p	1080/59.94p 1080/59.94i		
				1080/29.97p	1080/29.97p		
				720/59.94p	720/59.94p		
				2160/50p	1080/50p* <sup>2</sup> 1080/50i* <sup>2</sup>		
				2160/25p	1080/25p		
				1080/100p	1080/50p* <sup>3</sup>		
				1080/50p	1080/50p 1080/50i		
				1080/25p	1080/25p		
				720/50p	720/50p		
				2160/24p	1080/24p		
				1080/24p	1080/24p		
				2160/23.98p	1080/23.98p		
		1080/23.98p	1080/23.98p				
		HDR OUTPUT SELECT	HDR(2020)	SDR(709), HDR(709), HDR(2020)			
		V-LOG OUTPUT SELECT	V-LOG	V-LOG, V-709			
		OUTPUT ITEM	MENU ONLY	MENU ONLY, STATUS			
		CHAR	ON	OFF, ON			
3G SDI	LEVEL-A	LEVEL-A, LEVEL-B					

\*<sup>1</sup> When [UHD CROP] is [CROP(720)], output is 720/59.94p.

\*<sup>2</sup> When [UHD CROP] is [CROP(720)], output is 720/50p.

\*<sup>3</sup> For 119.88p (or 100p), "Frame 1" is output with the frame rate cut to half (59.94p (or 50p)).

## Camera menu item table (continued)

Top Menu	Camera menu	Item	Factory setting	Selection items	SCENE FILE	USER FILE			
OUTPUT	3G SDI OUT2/PM	OUTPUT SELECT	CAM	CAM, RETURN					
		FORMAT SELECT	1080/59.94p or 1080/50p	[System Format]	[3G SDI OUT2/PM]				
				2160/60p	1080/60p				
				1080/60p	1080/60p				
				2160/59.94p	1080/59.94p*1 1080/59.94i*1				
				2160/29.97p	1080/29.97p				
				1080/119.88p	1080/59.94p*3				
				1080/59.94p	1080/59.94p 1080/59.94i				
				1080/29.97p	1080/29.97p				
				720/59.94p	720/59.94p				
				2160/50p	1080/50p*2 1080/50i*2				
				2160/25p	1080/25p				
				1080/100p	1080/50p*3				
				1080/50p	1080/50p 1080/50i				
				1080/25p	1080/25p				
				720/50p	720/50p				
				2160/24p	1080/24p				
				1080/24p	1080/24p				
				2160/23.98p	1080/23.98p				
				1080/23.98p	1080/23.98p				
				HDR OUTPUT SELECT	HDR(2020)	SDR(709), HDR(709), HDR(2020)			
				V-LOG OUTPUT SELECT	V-LOG	V-LOG, V-709			
				OUTPUT ITEM	MENU ONLY	MENU ONLY, STATUS			
		CHAR	ON	OFF, ON					
		3G SDI	LEVEL-A	LEVEL-A, LEVEL-B					

\*1 When [UHD CROP] is [CROP(720)], output is 720/59.94p.

\*2 When [UHD CROP] is [CROP(720)], output is 720/50p.

\*3 For 119.88p (or 100p), "Frame 2" is output with the frame rate cut to half (59.94p (or 50p)).



Camera menu item table (continued)

Top Menu	Camera menu	Item	Factory setting	Selection items	SCENE FILE	USER FILE	
OUTPUT	HDMI	FORMAT SELECT	2160/59.94p or 2160/50p	[System Format]	[HDMI]		
				2160/60p	2160/60p 1080/60p		
				1080/60p	1080/60p		
				2160/59.94p	2160/59.94p 1080/59.94p*1		
				2160/29.97p	2160/29.97p 1080/29.97p		
				1080/119.88p	1080/119.88p		
				1080/59.94p	1080/59.94p 1080/59.94i		
				1080/29.97p	1080/29.97p		
				720/59.94p	720/59.94p		
				2160/50p	2160/50p 1080/50p*2		
				2160/25p	2160/25p 1080/25p		
				1080/100p	1080/100p		
				1080/50p	1080/50p 1080/50i		
				1080/25p	1080/25p		
				720/50p	720/50p		
2160/24p	2160/24p 1080/24p						
1080/24p	1080/24p						
2160/23.98p	2160/23.98p 1080/23.98p						
1080/23.98p	1080/23.98p						
	HDR OUTPUT SELECT	HDR(2020)	SDR(709), HDR(709), HDR(2020)			✓	
	V-LOG OUTPUT SELECT	V-LOG	V-LOG, V-709			✓	
	VIDEO SAMPLING	4:2:2/10bit	4:2:2/10bit, 4:2:0/8bit			✓	
	CHAR	ON	OFF, ON			✓	
RETURN	RETURN1 ID		RET.1	5 characters (Alphanumeric characters, spaces, ! # % & ' ( ) * + , - . / : ; < = > ? [ ] _ ~ \$ @  )		✓	
AUDIO	AUDIO	AUDIO	OFF	ON, OFF			
	INPUT1 SETTING	INPUT SELECT	LINE	LINE, MIC, MIC+48V			
		MIC GAIN	60dB	40dB, 60dB			
		LINE LEVEL	0dB	0dB, +4dB			
	INPUT2 SETTING	INPUT SELECT	LINE	LINE, MIC, MIC+48V			
		MIC GAIN	60dB	40dB, 60dB			
		LINE LEVEL	0dB	0dB, +4dB			
	OUTPUT SETTING	CH SELECT	INPUT1/INPUT2	INPUT1/INPUT2, INPUT1, INPUT2			
		CH1 VOLUME LEVEL	0dB	-40dB to 0dB to +20dB (1dB step)			
		CH2 VOLUME LEVEL	0dB	-40dB to 0dB to +20dB (1dB step)			
		HEAD ROOM	FS-12dB	FS-12dB, FS-18dB, FS-20dB			
ST2110 AUDIO FORMAT	INPUT1	1ms/8ch	1ms/8ch, 0.125ms/8ch				
	INPUT2	1ms/8ch	1ms/8ch, 0.125ms/8ch				

\*1 When [UHD CROP] is [CROP(720)], output is 720/59.94p.

\*2 When [UHD CROP] is [CROP(720)], output is 720/50p.

Camera menu item table (continued)

Top Menu	Camera menu	Item	Factory setting	Selection items		SCENE FILE	USER FILE
IP SIGNAL	NDI	FORMAT SELECT	2160/59.94p or 2160/50p	[System Format]	[NDI]		
				2160/60p	2160/60p* <sup>9</sup> 1080/60p		
				1080/60p	1080/60p		
				2160/59.94p	2160/59.94p* <sup>1, 2</sup> 1080/59.94p		
				2160/29.97p	2160/29.97p* <sup>3</sup> 1080/29.97p		
				1080/119.88p	1080/59.94p* <sup>10</sup>		
				1080/59.94p	1080/59.94p		
				1080/29.97p	1080/29.97p		
				720/59.94p	720/59.94p		
				2160/50p	2160/50p* <sup>4, 5</sup> 1080/50p		
				2160/25p	2160/25p* <sup>6</sup> 1080/25p		
				1080/100p	1080/50p* <sup>10</sup>		
				1080/50p	1080/50p		
				1080/25p	1080/25p		
				720/50p	720/50p		
	2160/24p	2160/24p* <sup>7</sup> 1080/24p					
	1080/24p	1080/24p					
	2160/23.98p	2160/23.98p* <sup>8</sup> 1080/23.98p					
	1080/23.98p	1080/23.98p					
	IP(H.264/H.265)		OUTPUT ITEM	MENU ONLY	MENU ONLY, STATUS		
CHAR			ON	OFF, ON			
ST2110		MOIP MODE	OFF	OFF, ON			
		MAIN VIDEO TX					
		FORMAT	1080/59.94p or 1080/50p	[System Format]	[ST2110]		
				1080/59.94p	1080/59.94p 1080/59.94i		
				1080/50p	1080/50p 1080/50i		
				For System Formats other than the above, display only			
		CROP VIDEO TX					
		FORMAT	1080/59.94p or 1080/50p	Display only			
MONITOR VIDEO TX							
FORMAT	1080/59.94p or 1080/50p	Display only					
RET VIDEO RX							
FORMAT	1080/59.94p or 1080/50p	Display only					

- \*1 When [UHD CROP] is [CROP(1080)], output is 1080/59.94p.
- \*2 When [UHD CROP] is [CROP(720)], output is 720/59.94p.
- \*3 When [UHD CROP] is [CROP(1080)], output is 1080/29.97p.
- \*4 When [UHD CROP] is [CROP(1080)], output is 1080/50p.
- \*5 When [UHD CROP] is [CROP(720)], output is 720/50p.
- \*6 When [UHD CROP] is [CROP(1080)], output is 1080/25p.
- \*7 When [UHD CROP] is [CROP(1080)], output is 1080/24p.
- \*8 When [UHD CROP] is [CROP(1080)], output is 1080/23.98p.
- \*9 When [UHD CROP] is [CROP(1080)], output is 1080/60p.
- \*10 For 119.88p (or 100p), "Frame 1" is output with the frame rate cut to half (59.94p (or 50p)).

Camera menu item table (continued)

Top Menu	Camera menu	Item	Factory setting	Selection items	SCENE FILE	USER FILE
PAINT	AUTO	AGC	OFF	OFF, ON	✓	✓
		AUTO IRIS	ON	OFF, ON	✓	✓
		ATW	OFF	OFF, ON	✓	✓
		AUTO SHUTTER	OFF	OFF, ON	✓	✓
		KNEE MODE	AUTO	AUTO, MANUAL	✓	✓
	GAIN SETTING	GAIN	0dB	-6dB to 12dB	✓	✓
		AGC	OFF	OFF, ON	✓	✓
		AGC MAX GAIN	12dB	6dB, 12dB	✓	✓
		FRAME MIX SW	OFF	OFF, ON	✓	✓
		FRAME MIX	6dB	6dB, 12dB, 18dB, 24dB	✓	✓
		DAY/NIGHT	DAY	DAY, NIGHT	✓	✓
	IRIS	AUTO IRIS	ON	OFF, ON	✓	✓
		WINDOW SELECT	1	1 to 4	✓	✓
		PICTURE LEVEL	0	-50 to +50 (1 step)	✓	✓
		PEAK RATIO	30	0 to 100	✓	✓
		AUTO IRIS CLOSE LIMIT	NORMAL	NORMAL, F8, F7, F5.6	✓	✓
		IRIS SPEED	2	1 to 3	✓	✓
	W/B BAL SETTING	ATW	OFF	OFF, ON	✓	✓
		WHITE BALANCE MODE	AWB A	AWB A, AWB B, 3200K, 5600K, VAR	✓	✓
		W.BAL VAR	3200K	2000K to 15000K	✓	✓
		ATW SPEED	NORMAL	NORMAL, SLOW, FAST	✓	✓
		ATW TARGET R	0	-10 to +10	✓	✓
		ATW TARGET B	0	-10 to +10	✓	✓
		SHOCKLESS WB SW	OFF	OFF, ON	✓	✓
		SHOCKLESS WB SPEED	4	1 to 5	✓	✓
	SHUTTER SPEED	SHUTTER SW	OFF	OFF, ON		✓
		AUTO SHUTTER	OFF	OFF, ON		✓
		AUTO SHUTTER LIMIT	1/100	1/100, 1/120, 1/250	✓	✓
		SHUTTER MODE	STEP	STEP, SYNCHRO		✓
		SHUTTER SPEED	1/100	<ul style="list-style-type: none"> <li>• 60p mode 1/100, 1/120, 1/125, 1/250, 1/500, 1/1000, 1/1500, 1/2000</li> <li>• 59.94i/59.94p mode 1/100, 1/120, 1/125, 1/250, 1/500, 1/1000, 1/1500, 1/2000</li> <li>• 50i/50p mode 1/60, 1/100, 1/125, 1/250, 1/500, 1/1000, 1/1500, 1/2000</li> <li>• 29.97p mode 1/48, 1/50, 1/60, 1/96, 1/100, 1/120, 1/125, 1/250, 1/500, 1/1000, 1/1500, 1/2000</li> <li>• 25p mode 1/48, 1/50, 1/60, 1/96, 1/100, 1/120, 1/125, 1/250, 1/500, 1/1000, 1/1500, 1/2000</li> <li>• 23.98p mode 1/48, 1/50, 1/60, 1/96, 1/100, 1/120, 1/125, 1/250, 1/500, 1/1000, 1/1500, 1/2000</li> <li>• 119.88p mode 1/125, 1/250, 1/500, 1/1000, 1/1500, 1/2000</li> <li>• 100p mode 1/125, 1/250, 1/500, 1/1000, 1/1500, 1/2000</li> </ul>	✓	✓
		SYNCHRO SCAN	<ul style="list-style-type: none"> <li>• 60p/59.94i/59.94p 60.0Hz</li> <li>• 50i/50p 50.0Hz</li> <li>• 29.97p 30.0Hz</li> <li>• 25p 25.0Hz</li> <li>• 23.98p 24.0Hz</li> <li>• 119.88p 120Hz</li> <li>• 100p 100Hz</li> </ul>	<ul style="list-style-type: none"> <li>• 60p mode 60.0Hz to 7200Hz</li> <li>• 59.94i/59.94p mode 60.0Hz to 7200Hz</li> <li>• 50i/50p mode 50.0Hz to 7200Hz</li> <li>• 29.97p mode 30.0Hz to 7200Hz</li> <li>• 25p mode 25.0Hz to 7200Hz</li> <li>• 23.98p mode 24.0Hz to 7200Hz</li> <li>• 119.88p mode 120.1Hz to 7200Hz</li> <li>• 100p mode 100.1Hz to 7200Hz</li> </ul>	✓	✓

**Camera menu item table (continued)**

Top Menu	Camera menu	Item	Factory setting	Selection items	SCENE FILE	USER FILE	
PAINT	PEDESTAL	MASTER PEDESTAL	0	-200 to +200 (1 step)	✓	✓	
		R PEDESTAL	0	-800 to 0 to +800	✓	✓	
		G PEDESTAL	0	-800 to 0 to +800	✓	✓	
		B PEDESTAL	0	-800 to 0 to +800	✓	✓	
		PEDESTAL OFFSET	OFF	OFF, ON	✓	✓	
	CHROMA	CHROMA LEVEL SW	OFF	OFF, ON	✓	✓	
		CHROMA LEVEL	0	-100% to 40%	✓	✓	
	COLOR TEMP SETTING	COLOR TEMP ACH/BCH					
		COLOR TEMP ACH	3200K	2000K to 15000K	✓	✓	
		R GAIN ACH	0	-400 to +400	✓	✓	
		B GAIN ACH	0	-400 to +400	✓	✓	
		G AXIS ACH	0	-400 to +400	✓	✓	
		COLOR TEMP BCH	3200K	2000K to 15000K	✓	✓	
		R GAIN BCH	0	-400 to +400	✓	✓	
		B GAIN BCH	0	-400 to +400	✓	✓	
	RGB GAIN CONTROL SETTING	G GAIN REL CONTROL SW	OFF	OFF, ON	✓	✓	
		RGB GAIN PRESET				✓	✓
		R GAIN	0	-1000 to +1000	✓	✓	
		G GAIN	0	-1000 to +1000	✓	✓	
		B GAIN	0	-1000 to +1000	✓	✓	
		RGB GAIN ACH/BCH				✓	✓
		R GAIN ACH	0	-1000 to +1000	✓	✓	
		G GAIN ACH	0	-1000 to +1000	✓	✓	
		B GAIN ACH	0	-1000 to +1000	✓	✓	
		GAIN OFFSET ACH	OFF	OFF, ON	✓	✓	
		R GAIN BCH	0	-1000 to +1000	✓	✓	
		G GAIN BCH	0	-1000 to +1000	✓	✓	
		B GAIN BCH	0	-1000 to +1000	✓	✓	
	GAIN OFFSET BCH	OFF	OFF, ON	✓	✓		
	FLARE	FLARE	ON	OFF, ON	✓	✓	
		MASTER FLARE	0	-200 to 0 to +200	✓	✓	
		R FLARE	0	-200 to 0 to +200	✓	✓	
		G FLARE	0	-200 to 0 to +200	✓	✓	
		B FLARE	0	-200 to 0 to +200	✓	✓	
	GAMMA/BLACK GAMMA	GAMMA	ON	OFF, ON	✓	✓	
		GAMMA MODE SELECT	HD	HD, NORMAL, CINEMA1, CINEMA2	✓	✓	
		MASTER GAMMA	0.45	0.15 to 0.75 (0.01 step)	✓	✓	
		R GAMMA	0	-75 to +75	✓	✓	
		B GAMMA	0	-75 to +75	✓	✓	
		BLACK GAMMA	OFF	OFF, ON	✓	✓	
		MASTER BLACK GAMMA	0	-48 to +48	✓	✓	
		R BLACK GAMMA	0	-20 to +20	✓	✓	
B BLACK GAMMA		0	-20 to +20	✓	✓		
BLACK GAMMA RANGE		1	1 to 3	✓	✓		
INITIAL GAMMA		4.5	4.0, 4.5, 5.0	✓	✓		

**Camera menu item table (continued)**

Top Menu	Camera menu	Item	Factory setting	Selection items	SCENE FILE	USER FILE	
PAINT	KNEE	KNEE	ON	OFF, ON	✓	✓	
		KNEE MODE	AUTO	AUTO, MANUAL	✓	✓	
		KNEE MASTER POINT	0.95	80.00% to 110.00% (0.25% step)	✓	✓	
		KNEE R POINT	0	-25.00% to 25.00% (0.25% step)	✓	✓	
		KNEE B POINT	0	-25.00% to 25.00% (0.25% step)	✓	✓	
		KNEE MASTER SLOPE	130	00 to 199	✓	✓	
		KNEE R SLOPE	0	-99 to +99	✓	✓	
		KNEE B SLOPE	0	-99 to +99	✓	✓	
		AUTO KNEE RESPONSE	4	1 to 8	✓	✓	
	WHITE CLIP	WHITE CLIP	ON	OFF, ON	✓	✓	
		MASTER WHITE CLIP LEVEL	109	80% to 109%	✓	✓	
		R WHITE CLIP LEVEL	0	-15% to +15%	✓	✓	
		B WHITE CLIP LEVEL	0	-15% to +15%	✓	✓	
		HI-COLOR	OFF	OFF, ON	✓	✓	
		HI-COLOR LEVEL	32	1 to 32	✓	✓	
	DRS	DRS	OFF	OFF, ON	✓	✓	
		EFFECT DEPTH	5	1 to 5	✓	✓	
	DETAIL SETTING	DETAIL	ON	OFF, ON	✓	✓	
		MASTER DETAIL	0	-31 to +31	✓	✓	
		PEAK FREQUENCY	6	1 to 8	✓	✓	
		CRISP	0	00 to 63	✓	✓	
		DETAIL GAIN(+)	0	-31 to +31	✓	✓	
		DETAIL GAIN(-)	0	-31 to +31	✓	✓	
		DETAIL CLIP(+)	0	00 to 63	✓	✓	
		DETAIL CLIP(-)	0	00 to 63	✓	✓	
		KNEE APERTURE LEVEL	0	00 to 39	✓	✓	
		DETAIL KNEE	0	00 to 15	✓	✓	
		LEVEL DEPENDENT SW	OFF	OFF, ON	✓	✓	
		LEVEL DEPENDENT	8	00 to 15	✓	✓	
		DARK DETAIL SW	OFF	OFF, ON	✓	✓	
		DARK DETAIL	3	0 to 7	✓	✓	
	DOWNCON SETTING	CHROMA					
		CHROMA LEVEL SW	OFF	OFF, ON	✓	✓	
		CHROMA LEVEL	0	-100% to 40%	✓	✓	
		DETAIL SETTING					
		DETAIL	ON	OFF, ON	✓	✓	
		MASTER DETAIL	0	-31 to +31	✓	✓	
		H DETAIL LEVEL	7	00 to 63	✓	✓	
		V DETAIL LEVEL	7	00 to 63	✓	✓	
		PEAK FREQUENCY	22.4MHz	12.4MHz to 37.1MHz	✓	✓	
		V DETAIL FREQUENCY	10	00 to 31	✓	✓	
		CRISP	10	00 to 63	✓	✓	
		DETAIL CLIP(+)	0	00 to 63	✓	✓	
DETAIL CLIP(-)		0	00 to 63	✓	✓		
KNEE APERTURE LEVEL		0	00 to 39	✓	✓		
DETAIL KNEE		0	00 to 15	✓	✓		
LEVEL DEPENDENT SW		OFF	OFF, ON	✓	✓		
LEVEL DEPENDENT		8	00 to 15	✓	✓		
DARK DETAIL SW		OFF	OFF, ON	✓	✓		
DARK DETAIL	2	0 to 7	✓	✓			

**Camera menu item table (continued)**

Top Menu	Camera menu	Item	Factory setting	Selection items	SCENE FILE	USER FILE
PAINT	DOWNCON SETTING	SKIN TONE DETAIL SETTING				
		SKIN TONE DETAIL	OFF	OFF, ON	✓	✓
		MEMORY SELECT	A	A, B, C	✓	✓
		ZEBRA	OFF	OFF, ON	✓	✓
		ZEBRA EFFECT MEMORY	A+B+C	A, B, C, A+B, A+C, B+C, A+B+C	✓	✓
		SKIN TONE EFFECT MEMORY	A+B+C	A, B, C, A+B, A+C, B+C, A+B+C	✓	✓
		SKIN TONE CRISP	8	0 to 8	✓	✓
		I CENTER	65	000 to 255	✓	✓
		I WIDTH	63	000 to 255	✓	✓
	Q WIDTH	32	000 to 127	✓	✓	
	Q PHASE	90	0 to 359	✓	✓	
	SKIN TONE DETAIL SETTING	SKIN TONE DETAIL	OFF	OFF, ON	✓	✓
		MEMORY SELECT	A	A, B, C	✓	✓
		ZEBRA	OFF	OFF, ON	✓	✓
		ZEBRA EFFECT MEMORY	A+B+C	A, B, C, A+B, A+C, B+C, A+B+C	✓	✓
		SKIN TONE EFFECT MEMORY	A+B+C	A, B, C, A+B, A+C, B+C, A+B+C	✓	✓
		SKIN TONE CRISP	63	-63 to 0 to +63	✓	✓
		I CENTER	65	000 to 255	✓	✓
		I WIDTH	63	000 to 255	✓	✓
		Q WIDTH	32	000 to 255	✓	✓
	Q PHASE	90	0 to 359	✓	✓	
	LINEAR MATRIX	PRESET MATRIX	HD	HD, NORMAL, CINEMA1, CINEMA2, USER	✓	✓
		MATRIX	OFF	OFF, ON	✓	✓
		LINEAR MATRIX	OFF	OFF, ON	✓	✓
		LINEAR TABLE	A	A, B	✓	✓
		COLOR CORRECT	OFF	OFF, ON	✓	✓
		COLOR CORRECT TABLE	A	A, B	✓	✓
		MATRIX (R-G)_N	0	-31 to +31	✓	✓
		MATRIX (R-G)_P	0	-31 to +31	✓	✓
		MATRIX (R-B)_N	0	-31 to +31	✓	✓
		MATRIX (R-B)_P	0	-31 to +31	✓	✓
		MATRIX (G-R)_N	0	-31 to +31	✓	✓
		MATRIX (G-R)_P	0	-31 to +31	✓	✓
MATRIX (G-B)_N		0	-31 to +31	✓	✓	
MATRIX (G-B)_P		0	-31 to +31	✓	✓	
MATRIX (B-R)_N		0	-31 to +31	✓	✓	
MATRIX (B-R)_P	0	-31 to +31	✓	✓		
MATRIX (B-G)_N	0	-31 to +31	✓	✓		
MATRIX (B-G)_P	0	-31 to +31	✓	✓		

Camera menu item table (continued)

Top Menu	Camera menu	Item	Factory setting	Selection items	SCENE FILE	USER FILE
PAINT	COLOR CORRECTION	PRESET MATRIX	HD	HD, NORMAL, CINEMA1, CINEMA2, USER	✓	✓
		MATRIX	OFF	OFF, ON	✓	✓
		LINEAR MATRIX	OFF	OFF, ON	✓	✓
		LINEAR TABLE	A	A, B	✓	✓
		COLOR CORRECT	OFF	OFF, ON	✓	✓
		COLOR CORRECT TABLE	A	A, B	✓	✓
		G SAT	0	-127 to 0 to +126	✓	✓
		G PHASE	0	-127 to 0 to +126	✓	✓
		G_CY SAT	0	-127 to 0 to +126	✓	✓
		G_CY PHASE	0	-127 to 0 to +126	✓	✓
		CY SAT	0	-127 to 0 to +126	✓	✓
		CY PHASE	0	-127 to 0 to +126	✓	✓
		CY_B SAT	0	-127 to 0 to +126	✓	✓
		CY_B PHASE	0	-127 to 0 to +126	✓	✓
		B SAT	0	-127 to 0 to +126	✓	✓
		B PHASE	0	-127 to 0 to +126	✓	✓
		B_MG SAT	0	-127 to 0 to +126	✓	✓
		B_MG PHASE	0	-127 to 0 to +126	✓	✓
		MG_SAT	0	-127 to 0 to +126	✓	✓
		MG_PHASE	0	-127 to 0 to +126	✓	✓
		MG_R SAT	0	-127 to 0 to +126	✓	✓
		MG_R PHASE	0	-127 to 0 to +126	✓	✓
		R SAT	0	-127 to 0 to +126	✓	✓
		R PHASE	0	-127 to 0 to +126	✓	✓
		R_YE SAT	0	-127 to 0 to +126	✓	✓
		R_YE PHASE	0	-127 to 0 to +126	✓	✓
		YE SAT	0	-127 to 0 to +126	✓	✓
		YE PHASE	0	-127 to 0 to +126	✓	✓
		YE_G SAT	0	-127 to 0 to +126	✓	✓
		YE_G PHASE	0	-127 to 0 to +126	✓	✓

Camera menu item table (continued)

Top Menu	Camera menu	Item	Factory setting	Selection items	SCENE FILE	USER FILE	
PAINT	DNR	DNR	ON	OFF, ON	✓	✓	
		DNR LEVEL	3	1 to 5	✓	✓	
	V-LOG PAINT	COLOR TEMP SETTING					
		COLOR TEMP ACH/BCH					
		COLOR TEMP ACH	3200K	2000K to 15000K	✓	✓	
		R GAIN ACH	0	-400 to +400	✓	✓	
		B GAIN ACH	0	-400 to +400	✓	✓	
		G AXIS ACH	0	-400 to +400	✓	✓	
		COLOR TEMP BCH	3200K	2000K to 15000K	✓	✓	
		R GAIN BCH	0	-400 to +400	✓	✓	
		B GAIN BCH	0	-400 to +400	✓	✓	
		G AXIS BCH	0	-400 to +400	✓	✓	
		DNR					
		DNR	ON	OFF, ON	✓	✓	
		DNR LEVEL	3	1 to 5	✓	✓	
	HDR PAINT	HLG MODE	FIX	FIX, VAR	✓	✓	
		SDR CONVERT MODE	FIX	FIX, VAR	✓	✓	
		GAMMA/BLACK GAMMA					
		BLACK GAMMA	OFF	OFF, ON	✓	✓	
		MASTER BLACK GAMMA	0	-32 to +32	✓	✓	
		R BLACK GAMMA	0	-32 to +32	✓	✓	
	KNEE	KNEE	ON	OFF, ON	✓	✓	
		KNEE POINT	100	60.00 to 100.00 (0.25% step)	✓	✓	
		KNEE SLOPE	0	00 to 199	✓	✓	
	SDR CONVERT	GAIN	-6	0dB, -5dB, -6dB, -7dB, -8dB, -9dB, -10dB, -11dB, -12dB	✓	✓	
		POINT	100	000 to 100	✓	✓	
		SLOPE	0	000 to 127	✓	✓	
		BLACK OFFSET	0	-100 to +100	✓	✓	
	PAINT SWITCH	FLARE	ON	OFF, ON	✓	✓	
		GAMMA	ON	OFF, ON	✓	✓	
		BLACK GAMMA	OFF	OFF, ON	✓	✓	
		KNEE	ON	OFF, ON	✓	✓	
		WHITE CLIP	ON	OFF, ON	✓	✓	
		DRS	OFF	OFF, ON	✓	✓	
		DETAIL	ON	OFF, ON	✓	✓	
		SKIN TONE DETAIL	OFF	OFF, ON	✓	✓	
		MATRIX	OFF	OFF, ON	✓	✓	
		LINEAR MATRIX	OFF	OFF, ON	✓	✓	
	COLOR CORRECT	OFF	OFF, ON	✓	✓		



**Camera menu item table (continued)**

Top Menu	Camera menu	Item	Factory setting	Selection items	SCENE FILE	USER FILE
<b>LENS</b>	FOCUS MODE		AUTO	MANUAL, AUTO		✓
	AF SENSITIVITY		NORMAL	NORMAL, STABLE		✓
	ZOOM MODE		Opt.ZOOM	Opt.ZOOM, i.ZOOM, D.ZOOM		✓
		MAX DIGITAL ZOOM	x10	x2 to x10 (1 step)		✓
	DIGITAL EXTENDER		OFF	OFF, x1.4, x2.0		✓
	O.I.S.		OFF	OFF, ON		✓
	O.I.S. MODE		O.I.S.(STABLE)	O.I.S.(STABLE), O.I.S.(PAN/TILT), HYBRID(STABLE), HYBLID(PAN/TILT)		✓
ND FILTER		THROUGH	THROUGH, 1/4, 1/16, 1/64	✓	✓	
<b>MONITOR DISPLAY</b>	WFM	MODE	OFF	OFF, ON(Y), ON(Y/Pb/Pr)		✓
		POSITION	UR	UR, BR, BL, UL		✓
	STATUS INDICATOR	RETURN SELECT	OFF	OFF, ON		✓
		STATUS(AUTO)	OFF	OFF, ON		✓
LEVEL GAUGE		OFF	OFF, ON		✓	
<b>TRACKING DATA OUTPUT</b>	SERIAL		OFF	OFF, ON		✓
	IP		OFF	OFF, ON		✓
	INVERT PAN/TILT AXIS		OFF	OFF, ON		✓
	CAMERA ID		0xFF	0x00 to 0xFF		✓
<b>CROP</b>	UHD CROP		OFF	OFF, CROP(1080), CROP(720)		✓
	CROP ZOOM		OFF	OFF, ON		✓
	CROP AF		OFF	OFF, ON		✓
	3G SDI1 OUT		CROP	FULL, CROP		✓
	NDI OUT		CROP	FULL, CROP		✓
	IP(H.264/H.265) OUT1		CROP	FULL, CROP		✓
	IP(H.264/H.265) OUT2		CROP	FULL, CROP		✓
	CROP MARKER		YL+G+MG	OFF, YL, G, MG, YL+G, YL+MG, G+MG, YL+G+MG		✓
	CROP OUT		YL	YL, G, MG		✓
	CROP ADJUST		YL	YL, G, MG		✓
	CROP H POSITION		960	0 to 3072		✓
	CROP V POSITION		540	0 to 1728		✓
	CROP ZOOM RATIO		200.00%	120.00% to 500.00%		✓

**Camera menu item table (continued)**

Top Menu	Camera menu	Item	Factory setting	Selection items	SCENE FILE	USER FILE
PAN/TILT	INSTALL POSITION		DESKTOP	DESKTOP, HANGING		✓
	SMART PICTURE FLIP		OFF	OFF, AUTO		✓
		FLIP DETECT ANGLE	90deg	60 to 120deg (1deg step)		✓
	P/T SPEED MODE		NORMAL(60deg/s)	NORMAL(60deg/s), FAST1(90deg/s), FAST2(180deg/s)		✓
	P/T ACCELERATION SETTING	P/T ACCELERATION	AUTO	MANUAL, AUTO		✓
		RISE S-CURVE	15	0 to 30		✓
		FALL S-CURVE	15	0 to 30		✓
		RISE ACCELERATION	128	1 to 255		✓
		FALL ACCELERATION	128	1 to 255		✓
	SPEED WITH ZOOM POSITION		ON	OFF, ON		✓
	FOCUS ADJUST WITH PTZ.		OFF	OFF, ON		✓
PRIVACY MODE		OFF	OFF, ON		✓	
POWER ON POSITION		STANDBY	NONE, STANDBY, HOME, PRESET		✓	
	PRESET NUMBER	001	001 to 100		✓	
PRESET	PRESET SPEED UNIT		SPEED TABLE	SPEED TABLE, TIME		✓
		PRESET SPEED TABLE	FAST	SLOW, FAST		✓
		PRESET SPEED	When [PRESET SPEED UNIT] is set to [SPEED TABLE]: 20 When [PRESET SPEED UNIT] is set to [TIME]: 20s	When [PRESET SPEED UNIT] is set to [SPEED TABLE]: 1 to 30 When [PRESET SPEED UNIT] is set to [TIME]: 1s to 99s		✓
	PRESET ACCELERATION SETTING	PRESET ACCELERATION	AUTO	MANUAL, AUTO		✓
		RISE S-CURVE	15	0 to 30		✓
		FALL S-CURVE	15	0 to 30		✓
		RISE ACCELERATION	128	1 to 255		✓
		FALL ACCELERATION	128	1 to 255		✓
		RISE RAMP TIME	0.1s	0.1s to 10.0s		✓
		FALL RAMP TIME	0.1s	0.1s to 10.0s		✓
	PRESET SCOPE		MODE A	MODE A, MODE B, MODE C		✓
	PRESET DIGITAL EXTENDER		OFF	OFF, ON		✓
	PRESET CROP		OFF	OFF, ON		✓
	PRESET THUMBNAIL UPDATE		ON	OFF, ON		✓
	PRESET NAME		RESET	RESET, HOLD		✓
	PRESET IRIS		OFF	OFF, ON		✓
	PRESET SHUTTER		OFF	OFF, ON		✓
PRESET ZOOM MODE		MODE A	MODE A, MODE B		✓	
FREEZE DURING PRESET		OFF	OFF, ON		✓	

Camera menu item table (continued)

Top Menu	Camera menu	Item	Factory setting	Selection items	SCENE FILE	USER FILE
FILES	SCENE FILE	MODE	LOAD	LOAD, STORE		
		FILE NO	OFF	When [MODE] is set to [LOAD]: OFF/1 to 8 When [MODE] is set to [STORE]: 1 to 8		
		FILE NAME	SCENE1 to SCENE8	Within 15 characters (Alphanumeric characters, spaces, ! # % & ' ( ) * + , - . / : ; < = > ? [ ] _ ~ \$ @  )		✓
		LIST	SCENE1 SCENE2 SCENE3			
		EXECUTE	---	NO, YES		
	USER FILE	MODE	LOAD	LOAD, STORE		
		FILE NO	1	1, 2, 3		
		FILE NAME	USER1 to USER3	Within 15 characters (Alphanumeric characters, spaces, ! # % & ' ( ) * + , - . / : ; < = > ? [ ] _ ~ \$ @  )		✓
		LIST	USER1 USER2 USER3			
		EXECUTE	---	NO, YES		
MAINTENANCE	FAN SETTING	FAN1	HIGH	AUTO, LOW, MID, HIGH		✓
		FAN2	HIGH	AUTO, LOW, MID, HIGH		✓
	DATE/TIME	PRESENT		(Current time displayed)		
		DATE YY	23	23 to 99		
		DATE MM	01	01 to 12		
		DATE DD	01	01 to 31		
		TIME HH	00	00 to 23		
		TIME MM	00	00 to 59		
		TIME SS	00	00 to 59		
		SET EXECUTE	---	NO, YES		
		RESET	---	NO, YES		
	INITIALIZE	MENU INITIALIZE	---	NO, YES		
		ALL DATA INITIALIZE	---	NO, YES		
	VERSION	SYSTEM VERSION	Shipped version			
	HOUR METER	OPERATION	00000000	(Display only) 8-digit number		
		FAN1	00000000	(Display only) 8-digit number		
		FAN2	00000000	(Display only) 8-digit number		
	HDMI STATUS	CONNECT	---	---		
		FORMAT	---	---		
		VIDEO SAMPLING	---	---		
		MONITOR	---	---		

**Camera menu item table (continued)**

Top Menu	Camera menu	Item	Factory setting	Selection items	SCENE FILE	USER FILE
MAINTENANCE	ERROR STATUS	LENS		(Display only) NO ERROR, ERROR		
		PAN/TILT		(Display only) NO ERROR, ERROR		
		FAN1		(Display only) NO ERROR, ERROR		
		FAN2		(Display only) NO ERROR, ERROR		
		TEMPERATURE		(Display only) NO ERROR, HIGH TEMPERATURE, SENSOR ERROR		
	WHITE SHADING	CORRECT	OFF	OFF, ON		
		W H SAW R	0	-100 to 0 to +100		
		W H SAW G	0	-100 to 0 to +100		
		W H SAW B	0	-100 to 0 to +100		
		W H PARA R	0	-100 to 0 to +100		
		W H PARA G	0	-100 to 0 to +100		
		W H PARA B	0	-100 to 0 to +100		
		W V SAW R	0	-100 to 0 to +100		
		W V SAW G	0	-100 to 0 to +100		
		W V SAW B	0	-100 to 0 to +100		
		W V PARA R	0	-100 to 0 to +100		
		W V PARA G	0	-100 to 0 to +100		
		W V PARA B	0	-100 to 0 to +100		
	WIRELESS CONTROL	WIRELESS CONTROL	ENABLE	ENABLE, DISABLE		✓
		WIRELESS ID	CAM1	CAM1, CAM2, CAM3, CAM4		✓
STATUS LAMP	STATUS LAMP	ENABLE	ENABLE, DISABLE		✓	

# Displaying the web screen

With a personal computer connected to the unit, it is possible to view the camera's IP videos or select various settings from the web browser.

The LAN crossover cable is used when connecting a personal computer directly to the unit's LAN connector for IP control, and the LAN straight cable is used when making the connection through a switching hub.

Select an IP address for the personal computer within the private address range while ensuring that it is different from the address of the unit. Set the subnet mask to the same address as the unit.

## <NOTE>

- If you need to change the IP address and subnet mask, be sure to ask your dealer to make these changes for you.

### Unit's IP address and subnet mask (factory settings)\*1

#### <LAN>

IP address: 192.168.0.10  
Subnet mask: 255.255.255.0

\*1 The factory default for the private address range is between 192.168.0.1 and 192.168.0.255.

#### <SFP+>

IP address: 192.168.0.10  
Subnet mask: 255.255.255.0

\*1 The factory default for the private address range is between 192.168.1.1 and 192.168.1.255.

#### <USB3.0 HOST>

IP address: 192.168.3.10  
Subnet mask: 255.255.255.0

\*1 The factory default for the private address range is between 192.168.3.1 and 192.168.3.255.

- If the controller and web browser are being used at the same time, the content selected using the controller may not be reflected on the web browser display.  
When using both the controller and web browser, be absolutely sure to check the settings using the controller or camera menu.

**For details of the required personal computer environment, refer to page 10.**

## <NOTE>

- Some functions on the web setting screen can be used only from Microsoft Edge (IE mode).  
Functions only available with Microsoft Edge (IE mode) are indicated with the **Microsoft Edge (I.E. Mode)** symbol.
- The "Network Camera View 4S" plug-in viewer software must have already been installed in order to display the unit's IP videos using Microsoft Edge (IE mode).  
This is not necessary when using any web browser other than Microsoft Edge (IE mode).  
For details, refer to "Installing the plug-in viewer software" (→ page 35).
- When [IP(UDP)] of [Tracking Data Output] is set to [On] and opening the web screen, a warning message will be displayed. Click the [Continue] button to leave the web screen open.
- While the web screen is displayed, the tracking data that is output when [IP(UDP)] of [Tracking Data Output] is [On] may be delayed or the data value may not be updated. (→ page 165)

## Displaying the web screen using a personal computer

The procedure is explained here using Windows screens (Internet Explorer). When using other browsers, some screen displays will be different, but the procedure is similar.

### 1. Start the web browser of the personal computer.

Use one of the web browsers below depending on the operating system installed in the personal computer.

Operating system installed	Web browser
Windows	Windows 10 Windows 10/Microsoft Edge Windows 10/Google Chrome
macOS	macOS13 macOS12 Safari Google Chrome

### 2. In the address bar of the web browser, enter the IP address set in EasyIP Setup Tool Plus.

#### IPv4 address entry example:

http://[URL registered with IPv4 address]  
http://192.168.0.10/

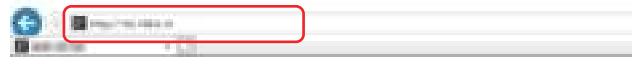

#### IPv6 address entry example:

http://[URL registered with IPv6 address]  
http://[2001:db8::10]/

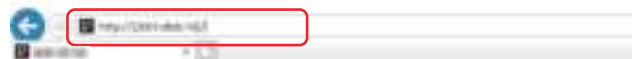

## <NOTE>

- If the HTTP port number has been changed from "80", enter "http://<camera IP address>:<port number>" in the address bar.  
Example: When the port number is set to 8080:  
http://192.168.0.10:8080
- If the unit is located on the local network, configure proxy server settings on the web browser ([Tools] - [Internet Options] in the menu bar) so that a proxy server is not used for the local address.
- For details on when [HTTPS] - [Connection] (→ page 174) is set to [HTTPS] in the [Advanced] of the network setup screen [Network], see "Accessing the Camera by HTTPS" (→ page 183).

### 3. Set the initial account.

In the initial state, the initial account setting screen is displayed when the web screen is displayed.

Set a user name and password.



#### <NOTE>

- Do not set character strings that can be easily guessed by third parties.
- Change the password at regular intervals.
- The password must use at least 3 of the following 4 character types and be 8 characters or longer.
  - Alphabet upper cases
  - Alphabet lower cases
  - Numerals
  - Symbols ( ! \$ % ' ( ) \* + , - . / ? @ [ ] ^ \_ ` ~ )
- When a password is set that does not adhere to the above policy, take responsibility for use of the device with due consideration for the security risks in the installation environment, etc.
- A warning is displayed if the set password goes against the recommended setting policy. When changing the password, click the [Back] button and set the password again.
 

When continuing with the setting with full understanding of the security risks, click [Continue] to complete the setting.
- If you forget the account information that was set, use the switches for initialization of service switches to reset the user information used for connecting to the network. (→ page 19)

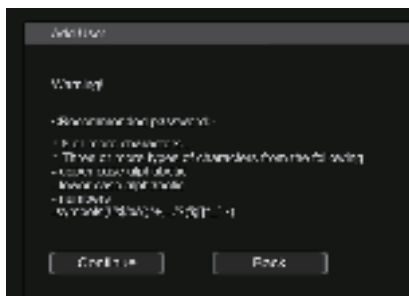

### 4. Completing registration of the initial account

After completing registration of the initial account, the following registration completed screen is displayed.

The live screen [Live] is automatically displayed after about 10 seconds elapse after the completed screen is displayed.

If the live screen [Live] is not displayed after 10 seconds elapse, manually move to the live screen [Live] by clicking the “please click here” link.

This completes the process of registering the initial account.

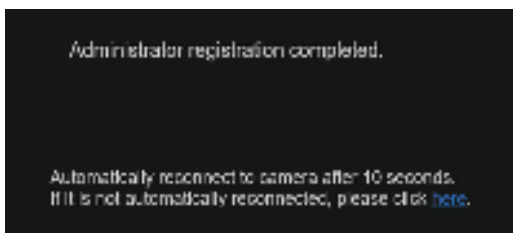

#### <NOTE>

- Network connection with AW-RP150 or AW-RP60 requires setup of an initial account. (→ page 34)
- When an initial account is not set up, AW-RP150 or AW-RP60 can detect but cannot control this unit.

### 5. Display the live screen [Live].

The web screen appears.

The live screen [Live] (→ page 104) is displayed initially. You can switch to the web setup screen [Setup] (→ page 110) when necessary. (→ page 103)



#### <NOTE>

- If the personal computer does not have the plug-in viewer software already installed, an installation confirmation message is displayed before the live screen [Live] is displayed. In a case like this, follow the on-screen instructions to install the software. [Microsoft Edge](#) For details, refer to “Installing the plug-in viewer software” (→ page 35).
- Depending on the firewall settings on your personal computer, transmitted images may not be displayed. If this occurs, change the firewall settings and change the settings to permit communications with your web browser.
- When an attempt is made to display multiple IP images on one personal computer, IP videos may not be displayed depending on the performance of the personal computer concerned.
 

**A maximum of 14 users, including users receiving IP video, can access the unit simultaneously. However, the number of users that can access the unit may be restricted to less than 14 depending on the network communication bandwidth used by the unit. A message indicating the access limit will appear if the number of users exceeds 14. When [Transmission type] is set to [Multicast port] for [H.264] or [H.265], the second and subsequent users receiving H.264 or H.265 images will not be counted toward the total access count.**
- When [H.264 transmission] (→ page 127) is set to [On], H.264 images are displayed. When it is set to [Off], JPEG images will be displayed. JPEG images can be displayed even when [H.264 transmission] is set to [On]. [Microsoft Edge](#)
- The JPEG image frame rate may be slower depending on the network environment, performance of your personal computer, subject of the video, and access volume.
- While IP video transmission (H.264/H.265/M-JPEG streaming) is being performed, there may be some delays in timing of the rendering of the OSD menu. Smooth rendering of the OSD menu becomes possible when you set [IP SIGNAL] – [IP(H.264/H.265)] – [CHAR] to [OFF]. (→ page 58, page 124)

### Switching between the Live screen [Live] and Web setup screen [Setup]

When the live screen [Live]  is displayed, click the [Setup] button  at the top of the live screen [Live].

For details on the web setup screen [Setup], see “Web setup screen [Setup]” (→ page 110).

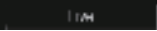
When the web setup screen [Setup]  is displayed, click the [Live] button  at the top of the web setup screen [Setup].

For details on the live screen [Live], see “Live screen [Live]” (→ page 104).

#### <NOTE>

- During Standby mode, the [Setup] button is disabled, and you cannot switch to the web setup screen [Setup].
- If the unit is switched to Standby mode from another terminal while the web setup screen [Setup] is displayed, the display will switch to the live screen [Live] after a few seconds.

### Logging into the Web screen

#### When user authentication is enabled

##### When displaying the live screen [Live]

You need to enter account information for a user with Camera control or Administrator privileges.

##### When displaying the web setup screen [Setup]

You need to enter account information for a user with Administrator privileges.

#### When user authentication is disabled

##### When displaying the live screen [Live]

It is not necessary to enter account information.

##### When displaying the web setup screen [Setup]

You need to enter account information for a user with Administrator privileges.

#### <NOTE>

- The account input screen is displayed in a pop up screen from your web browser.
- Correctly enter the user name and password that has already been registered.
- It is recommended that the password be changed at regular intervals.
- During Standby mode, the [Setup] button is disabled, and you cannot switch to the web setup screen [Setup].

# Web screen operations

## Live screen [Live]

You can display images from the camera on a personal computer and perform camera operations, such as pan, tilt, zoom, and focus control. The items displayed on the screen will differ depending on whether the [H.264] or [JPEG] button is selected under [Compression].

### When [H.264] is selected Microsoft Edge



**Operation screen display buttons (for touch panels)**  
Displays screen with larger operation buttons for touch panels. For details, refer to "Displaying the web screen using a personal computer equipped with a touch panel" (→ page 190).



**Expansion panel display button**  
(→ page 107, page 108)

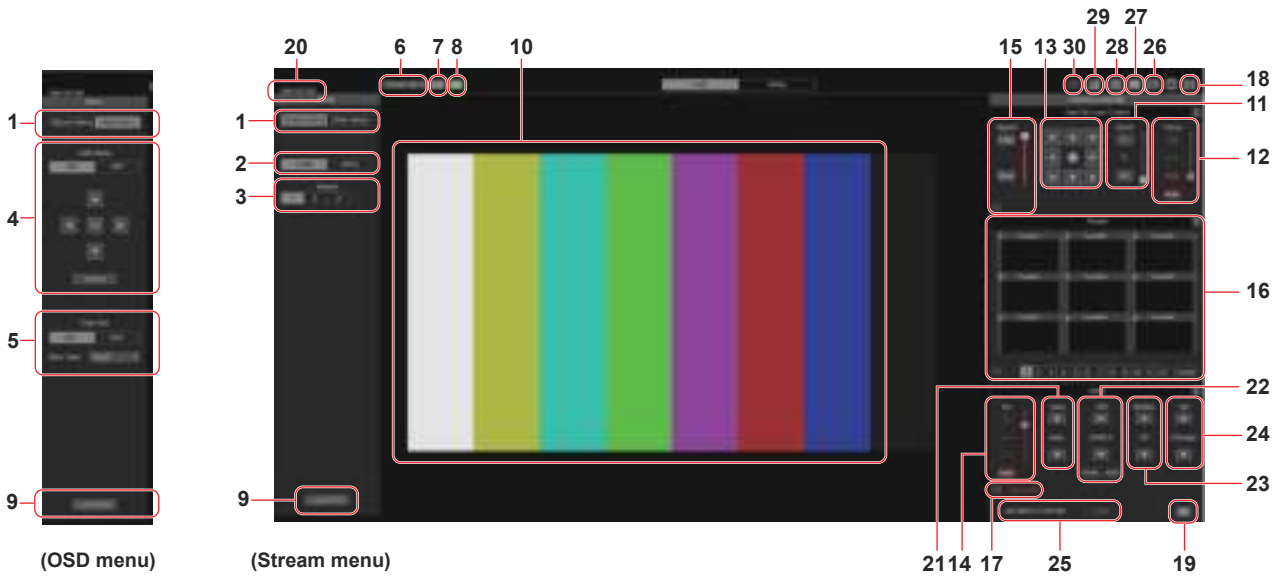

### When [JPEG] is selected



**Operation screen display buttons (for touch panels)**  
Displays screen with larger operation buttons for touch panels. For details, refer to "Displaying the web screen using a personal computer equipped with a touch panel" (→ page 190).



**Expansion panel display button**  
(→ page 107, page 108)

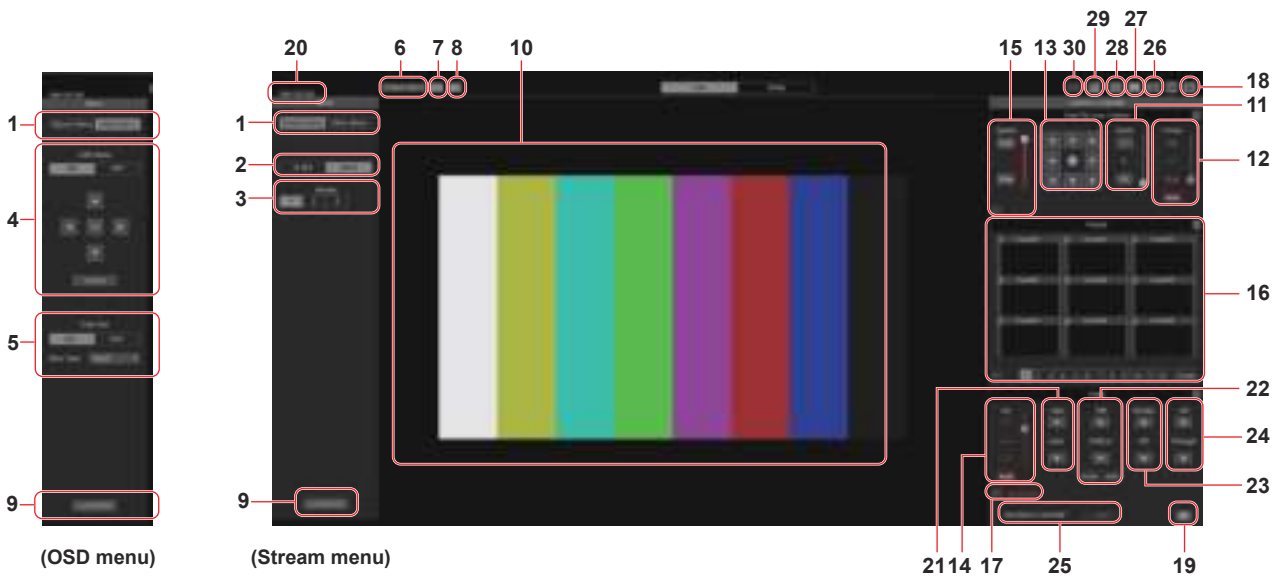





### 1. Menu switching [Stream Menu]/[Other Menu]

Switch between menu displays.

Clicking [Other Menu] when the Stream menu is displayed displays the Other menu.

Clicking [Stream Menu] when the Other menu is displayed displays the Stream menu.

### 2. Compression button [Compression]

 [H.264]	The [H.264] button turns gray, and H.264 images are displayed. <a href="#">Microsoft Edge</a> The [H.264] button is enabled when the [H.264 transmission] setting of [H.264(1)] to [H.264(3)] on the Video over IP is [On]. (→ page 127)
 [JPEG]	The [JPEG] button turns gray, and JPEG images are displayed.

**<NOTE>**



- In the following cases, the selection status of the [Compression] buttons will return to the setting configured in the [Video over IP] - [Initial display setting] - [Stream] (→ page 126).
  - When returning from another screen
  - When the screen is updated

### 3. Stream buttons [Stream]

**When H.264 is selected**

These buttons appear only when H.264 images are displayed.

[Microsoft Edge](#)



 [1]	When selected, the button turns gray, and the images in the main area appear according to the settings configured for [H.264(1)]. (→ page 127)
 [2]	When selected, the button turns gray, and the images in the main area appear according to the settings configured for [H.264(2)]. (→ page 127)
 [3]	When selected, the button turns gray, and the images in the main area appear according to the settings configured for [H.264(3)]. (→ page 127)

**<NOTE>**

- In the following cases, the selection status of the [Stream] buttons will return to the setting configured in the [Video over IP] - [Initial display setting] - [Stream] (→ page 126).
  - When returning from another screen
  - When the screen is updated
- If the H.264 image resolution is set to [1920x1080] or [1280x720], the image may be compressed depending on the size of the web browser window.

**When JPEG is selected**



These buttons appear only when JPEG images are displayed.

 [1]	When selected, the button turns gray, and the images in the main area appear according to the settings configured for [JPEG(1)]. (→ page 126)
 [2]	When selected, the button turns gray, and the images in the main area appear according to the settings configured for [JPEG(2)]. (→ page 126)
 [3]	When selected, the button turns gray, and the images in the main area appear according to the settings configured for [JPEG(3)]. (→ page 126)

**<NOTE>**

- The resolution selected with [JPEG(1)], [JPEG(2)], and [JPEG(3)] (→ page 126) under [JPEG] in the [Video over IP] will be used.
- If the resolution is set to [1920x1080] or [1280x720], the image may be compressed depending on the size of the web browser window.
- In the following cases, the selection status of the [Image Capture Size] buttons will return to the setting configured in the [Video over IP] - [Initial display setting] - [Stream] (→ page 126).
  - When returning from another screen
  - When the screen is updated

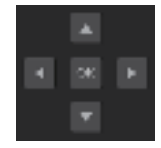

### 4. OSD Menu Operation [OSD Menu]

 [ON] [OFF]	Use this to select whether the camera's on-screen displays are to be shown.
 [Cancel]	It cancels the selection of the setting which is being changed. It restores the pre-change setting.
 [▲] [▼] [◀] [▶] [OK]	Use these to perform the menu operations. The items are selected using the [▲][▼][◀][▶] buttons. If a selected item has a sub menu, this sub menu is displayed by pressing the [OK] button. When the cursor is moved to any item on the bottom-level setting screen and the [OK] button is pressed, the setting of the selected item starts flashing. A setting for a regular menu item is reflected immediately if it is changed while it is still flashing. However, there are a number of menu items whose setting is reflected only after the [OK] button has been pressed, causing the setting to stop flashing and the new setting to be entered.



**<NOTE>**

- During IP video transmission (H.264/H.265/M-JPEG), there may be some delays in OSD menu operations. Smooth OSD menu operations become possible when you set [IP SIGNAL] – [IP(H.264/H.265)] – [CHAR] to [OFF]. (→ page 58, page 124)

### 5. Color bar button [Color bar]

 [ON] [OFF]	Switch the color bar signal displayed or hide.
 [Type1] [Type2] [Type3] [Type4] [Type5]	Switch the color bar displayed between Type1, Type2, Type3, Type4 and Type5. This is only enabled when [Color bar] is set to [ON].

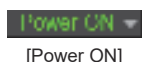
6. Power ON button [Power ON]/Standby button [Standby]

 [Power ON]	Turn the unit on.
 [Standby]	Set the unit to Standby mode.

In the Standby mode, all the buttons on the live screen [Live] except for the [Power ON] button and [Standby] button are disabled.

<NOTE>

- If [Power ON] or [Standby] is selected too quickly, the status selected and the display shown may not correspond. In a case like this, follow the steps below to restore the correct status display:

**For Windows:**

Press the [F5] key on the keyboard of the personal computer.

**For Mac:**

Press the [Command] + [R] keys on the keyboard of the personal computer.



**When operation is transferred to the Standby mode:**

The current Pan/Tilt/Zoom positions are stored. When [Standby] is selected in the [Power ON Position] menu, the information about the stored positions is used.

**When operation is transferred to the Power ON mode:**

Pan/Tilt/Zoom are moved to the positions selected in the [Power ON Position] menu.



7. SYNC status indicator [Sync]

	This unit uses a REF SIGNAL to synchronize with external synchronizing sources.
	This unit is not synchronized with an external synchronizing source.

<NOTE>

- Depending on the time setting of this unit, it may take a few minutes until this unit synchronizes from when there is input from the external synchronizing source.



8. Streaming status indicator [Live]

	This unit is currently streaming over IP to an external device (software).
	This unit is not currently streaming over IP to an external device (software).

<NOTE>

- The transmission statuses of M-JPEG and ST2110 are not included.

9. Operation lock button [Lock]

 [Lock(WEB)]	This prevents erroneous operation by locking operations such as pan/tilt, zoom, focus, iris, gain, white balance, shutter, ND filter, and preset in the live screen [Live]. The button turns red while locked, and the lock is released when the button is clicked again.
 [Lock(CAM)]	This is displayed when the unit is locked with the camera lock function on a Panasonic controller (AW-RP150, AW-RP60), and you can unlock the camera by clicking this.

<NOTE>

- When locked using a [Lock(WEB)] function, the status is maintained by the web browser, so the lock is released by redisplaying the web browser.
- The lock status using the [Lock(CAM)] function is maintained by the camera itself, so you need to either release the camera lock function using a Panasonic controller (AW-RP150, AW-RP60) or release [Lock(CAM)] from the web browser while the camera is locked.
- It is not possible to enable the [Lock(CAM)] function from the web browser.

10. Main area (IP video display area)



The IP video of the connected camera will be displayed.

When the tally lamp of the camera is on, a red and a green lines are displayed at the top of the videos. When receiving a red tally signal a red line is displayed. When receiving the green tally signal a green line is displayed. When receiving the yellow tally signal a yellow line is displayed.

When the tally lamp is off, the display area will return to normal.







When you click inside the area, the camera moves so the clicked position becomes the center of the area.

Operating the mouse wheel inside the display area allows you to use the plug-in viewer software's digital zoom. [Microsoft Edge](#)

<NOTE>

- When the shooting scenes vary significantly, restrictions imposed by the graphics processing (GDI) of the operating system installed may give rise to a phenomenon called "screen tearing" (where parts of the picture are not displayed in synchronization) although this will depend on the personal computer used.
- On Microsoft Edge (IE mode), if [H.264 transmission] (→ page 127) is set to [On], H.264 images can be displayed.
- On browsers other than Microsoft Edge (IE mode), only JPEG images can be displayed, irrespective of the [H.264 transmission] setting. (H.264 images cannot be displayed.)
- The speed at which the JPEG images are refreshed may be reduced depending on the network environment, performance of the personal computer used, subjects and number of access users.
- A total of 14 users, including users receiving IP video, can access the unit simultaneously.  
However, when the IP video transmission bandwidth reaches its upper limit, access may be restricted to less than 14 users.
- When [DISABLE] is selected for [TALLY] (→ page 49, page 115), the camera's tally lamp will not light even when the tally signal is input. However, a red and a green lines are displayed at the top of the main area (IP video display area).
- The camera may not move so the clicked position becomes the center of the area when you click inside the area within a tilt range of ±15° of the vertical of the unit.
- When [IP(UDP)] of [Tracking Data Output] is set to [On], video transmission via IP may be delayed or the video may suffer frame loss. (→ page 165)  
We recommend setting [IP(UDP)] of [Tracking Data Output] to [Off] to avoid the delay or frame loss due to the video transmission via IP.
- During IP video transmission (H.264/H.265/M-JPEG), there may be some delays in OSD menu operations. Smooth OSD menu operations become possible when you set [IP SIGNAL] – [IP(H.264/H.265)] – [CHAR] to [OFF]. (→ page 58, page 124)

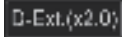



11.Zoom [Zoom]

 <p>[T] [W]</p>	<p>[T]: Use this to adjust the zoom (magnification) in the "Tele" direction.                  [W]: Use this to adjust the zoom (magnification) in the "Wide" direction.                  The optical zoom position is displayed in the center as a value.                  Value range: 000 (Wide end) to 999 (optical Tele end)</p>
	<p><b>Display button for PTZ expansion panel</b>                  The [D-Zoom], [D-Ext.(×1.4)], [D-Ext.(×2.0)], and [×1.0] buttons for zoom and [O.T.AF], [Touch AF] and [Focus Guide] buttons for focus (→ page 107) are displayed.                  The display changes to [-] while these are displayed, and they stop being displayed when this is pressed again.</p>
 <p>[×1.0]</p>	<p>Use this to adjust the zoom (magnification) to 1.0x.</p>
 <p>[D-Ext.(×1.4)]</p>	<p>Use this to enable or disable digital extender x1.4.</p>
 <p>[D-Ext.(×2.0)]</p>	<p>Use this to enable or disable digital extender x2.0.</p>
 <p>[D-Zoom]</p>	<p>Use this to enable or disable the digital zoom.</p>

<NOTE>

- The values indicating the optical zoom position do not change while zoom is still being operated within the digital zoom region.
- When digital zoom is enabled, it is possible to zoom in with the digital zoom by clicking the [T] button, even if the optical zoom position is optical Tele end 999.
- The [D-Zoom], [D-Ext.(×1.4)], [D-Ext.(×2.0)] and [×1.0] buttons are not displayed immediately after the live screen [Live] is displayed. They are displayed when the [Display button for PTZ expansion panel] is pressed.

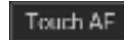
12.Focus [Focus]



 <p>[Far] [Near]</p>	<p>[Far]: Use this to adjust the focus in the "Far" direction. It does not work during automatic adjustments.                  [Near]: Use this to adjust the focus in the "Near" direction. It does not work during automatic adjustments.                  The focal distance is displayed in the center as a value.                  Value range: 00 (Near) to 99 (Far)</p>
 <p>[Auto]</p>	<p>Use this to switch between auto and manual focusing. When Auto is selected, the focus is adjusted automatically.</p>
 <p>[O.T.AF]</p>	<p>When this is pressed while the focus is being adjusted manually, the focus will be adjusted automatically once only.                  It does not work during automatic adjustments. It is displayed when the [Display button for PTZ expansion panel] (→ page 107) is pressed.</p>
 <p>[Touch AF]</p>	<p>When this is pressed while the focus is being adjusted manually, the focus will be adjusted automatically in the area touched. It does not work during automatic adjustments. It is displayed when the [Display button for PTZ expansion panel] (→ page 107) is pressed.</p>
 <p>[Focus Guide]</p>	<p>When this is pressed while focusing is manual, an icon is displayed to indicate the focus state of the touched area. It is displayed when the [Display button for PTZ expansion panel] (→ page 107) is pressed.</p>

<NOTE>

- The [O.T.AF], [Touch AF] and [Focus Guide] buttons are not displayed immediately after the live screen [Live] is displayed. They are displayed when the [Display button for PTZ expansion panel] is pressed.

Notes on the focus guide function

- When focusing is manual and [Focus Guide] is enabled, if you touch the screen, the following icons are displayed to indicate the focus state of the area you have touched.

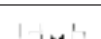
	<p>Focus state</p>
	<p>Focus is in front of subject                  Displayed in five steps</p>
	<p>Focus is beyond subject                  Displayed in five steps</p>
	<p>Focus state unknown</p>



<NOTE>

- The focus guide is turned off forcibly in the following situations:
  - When the [FOCUS MODE] is [AUTO]
  - When [UHD CROP] is set to anything other than [OFF]
- The focus state cannot be acquired in the following situations (the "Focus state unknown" icon is displayed):
  - When ZOOM magnification is within the i.Zoom/D.ZOOM range
  - When [DIGITAL EXTENDER] is set to anything other than [OFF]

13. Control pad and its buttons

	<p>To adjust the image in the horizontal or vertical direction (panning or tilting), left-click the pad and the buttons.</p> <p>It is possible to operate with the central grid pattern in the dragged state, with the speed of the pan/tilt increasing as it approaches the outside of the pad.</p>
---	--







14. Brightness [Iris]

 <p>[+] [-]</p>	<p>[+]: Operates in stages in the direction of iris opening. It does not work during automatic adjustments.</p> <p>[-]: Operates in stages in the direction of iris closing. It does not work during automatic adjustments.</p> <p>The F value is displayed in the center.</p>
 <p>[Auto]</p>	<p>Use this to switch the iris adjustment between auto and manual. When Auto is selected, the picture brightness is adjusted automatically.</p>

15. Speed [Speed]

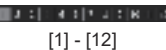
 <p>[Fast] [Slow]</p>	<p>Use this to select the speed at which the pan, tilt, zoom, and focus operations are to be performed. The speed of pan/tilt operation is reflected in grip button operations. It is not reflected in grip button operations.</p>
--	--



16. Preset [Preset]

	<p>When a preset thumbnail is clicked, the camera moves to face towards a preset position that was registered beforehand.</p> <p>You can select [Home] and [Preset1] to [Preset100].</p> <p>Preset numbers are displayed in green when they have had a preset position registered in them.</p>
 <p>(Preset name)</p>	<p>Preset names are displayed.</p> <p>During the preset registration mode, you can select a preset name and change the display name.</p> <p>You can enter between 1 to 15 characters. The characters available are 0 to 9, A to Z, a to z, spaces, and underscores (_).</p>
 <p>[1] - [12]</p>	<p>Switches the page of the displayed preset thumbnails.</p>
 <p>[Home]</p>	<p>Move to home position.</p>
	<p><b>Display button for preset expansion panel</b></p> <p>The [SET] and [DEL] buttons for presetting are displayed.</p> <p>The display changes to [-] while these are displayed, and they stop being displayed when this is pressed again.</p>
 <p>[SET]</p>	<p>The unit moves to the preset registration mode.</p> <p>When a preset thumbnail is clicked in the preset registration mode, it is registered in the preset position specified by the current condition.</p>
 <p>[DEL]</p>	<p>The unit moves to the preset delete mode.</p> <p>When a preset thumbnail is clicked in the preset delete mode, the specified preset position settings are deleted.</p>

<NOTE>

- If the [Preset Thumbnail Update] menu is [Off] when registering presets, the previously registered preset thumbnail is maintained.
- If the [Preset Name] menu is [Reset] when registering presets, the previously registered preset name is reset.
- The [SET] and [DEL] buttons are not displayed immediately after the live screen [Live] is displayed. They are displayed when the [Display button for preset expansion panel] is pressed.

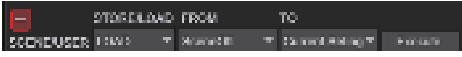
17. Scene/User [Scene/User]

 <p>[Scene1] to [Scene8], [User1] to [User3]</p>	<p>Select [Scene1] to [Scene8] or [User1] to [User3] to switch the shooting mode.</p>
	<p><b>Expansion panel display button for Scene/User</b></p> <p>Display the pull-down menu for switching scene/user files. The button changes to [-] while the menu is being displayed, and the menu is hidden again when you press the button again.</p>

<NOTE>

- Immediately after displaying the live screen [Live], the pull-down menu for switching scene/user files is not displayed. It is displayed when the [Expansion panel display button for Scene/User] is pressed.

18. Full-screen display button

	<p>Display the image in full-screen mode.</p> <p>To return to the live screen [Live], press the [Esc] key on the personal computer while the image is displayed in full-screen mode.</p> <p>The aspect ratio of the displayed image will be adjusted according to the monitor size.</p>
--	---

19. Snapshot button

	<p>Capture a snapshot (single still image), and display it in a separate window.</p>
---	--



<NOTE>

- Depending on the network environment, for example, if snapshot capture takes longer than a certain amount of time, the image may not appear.
- If [JPEG transmission(1)] - [JPEG transmission(3)] (→ page 126) are all set to [Off], the image captured with the snapshot button will be black.

20. Camera title display area

The name for the unit configured in [Camera title] in [Live page] in the System screen [System] (→ page 119) appears.





21. Gain [Gain]

	<p>Increase the gain of the images.</p>
	<p>Decrease the gain of the images.</p>

<NOTE>

- The current setting is displayed in the middle of the button.



**22.White balance [WB]**

	Switch the white balance in the order [AWB A], [AWB B], [3200K], [5600K], [VAR], [ATW].
	Switch the white balance in the order [AWB A], [ATW], [VAR], [5600K], [3200K], [AWB B].
	Automatic white balance (AWB) is executed and the white balance is reset.
	Automatic black balance (ABB) is executed and the black balance is reset.

**<NOTE>**

- The current setting is displayed in the middle of the button.



**23.Shutter [Shutter]**

	Switch the shutter mode in the order [Off], [Step], [Synchro], [Auto].
	Switch the shutter mode in the order [Auto], [Synchro], [Step], [Off].

**<NOTE>**

- The current setting is displayed in the middle of the button.

**24.ND filter [ND]**

	Switch the transmittance of the ND filter in the order [Through], [1/4 ND], [1/16 ND], [1/64 ND].
	Switch the transmittance of the ND filter in the order [1/64 ND], [1/16 ND], [1/4 ND], [Through].

**<NOTE>**

- The current setting is displayed in the middle of the button.
- ND filter switching is not possible in night mode.

**25.SRT/MPEG2-TS/RTMP**

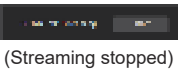
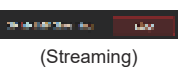
	Starts streaming to the transmission destination that was pre-registered. The button turns red during transmission, and transmission stops when the button is clicked again.
	

**<NOTE>**

- This button can be used only when [Streaming mode] is [RTMP], [SRT(H.264)], [SRT(H.264 UHD)], [SRT(H.265)], [SRT(H.265 UHD)], or [MPEG2-TS over UDP].
- When [Streaming mode] is [SRT(H.264)], [SRT(H.264 UHD)], [SRT(H.265)], or [SRT(H.265 UHD)], transmission can be started by clicking this button only when the Client(Call) mode is set.

**26.Button for switching the personal computer screen**

	Display the screen for mobile terminals. For details, refer to "Displaying the web screen using a mobile terminal" (→ page 192).
---	--

**<NOTE>**

- This button is displayed only when displaying on a mobile terminal.

**27.Preset thumbnail list display button**

	Display a list of Preset thumbnails on the live screen [Live].
---	--

**28.Button for switching real time updating**

	Frame dropping in images may be observed depending on the operating performance of the personal computer running the web browser. You can improve this problem by pressing this button to disable the real time updating function. Data items subject to real time updating are as follows. - Zoom - Focus - Iris - Gain - WB - Shutter - ND
---	--

**<NOTE>**

- The middle-click function is disabled if the button is enabled.
- The Audio Level Meter function is disabled if the button is enabled.

**29.Audio Level Meter display button**

	Display the status of audio input to this unit and the audio setting status on the live screen [Live].
---	--

**30.Level Gauge switching button**

	When [ON], the status of the incline (horizontally, to the left or right or front and back) of the unit installation is displayed as OSD in the top left of the screen. (Example) L↑ +3.2/-3.2 R F↓ -1.8/+1.8↑F
	In the case of the display above, the unit is installed at an inclination of 3.2° upward to the left and 1.8° upward in to the front. The maximum incline is ±9.9°, and when there is an incline of 10° or greater, the display shows "±9.9".

**<NOTE>**

- LEVEL GAUGE is displayed only through SDI, HDMI, and SMPTE ST2110. It is not displayed with High bandwidth NDI and IP transmission (H.264/H.265/M-JPEG).

# Web screen configurations

## Web setup screen [Setup]

The settings for the unit are selected on this screen.

### <NOTE>

- The setting menu operations can be performed only by users whose access level is "1.Administrator".  
For the procedure used to set the access level, refer to page 167.
- If the value of a setting is changed using the OSD menu or a different web browser, the setting value and the displayed value may not match. In that case, update the setup menu display screen of that web browser.

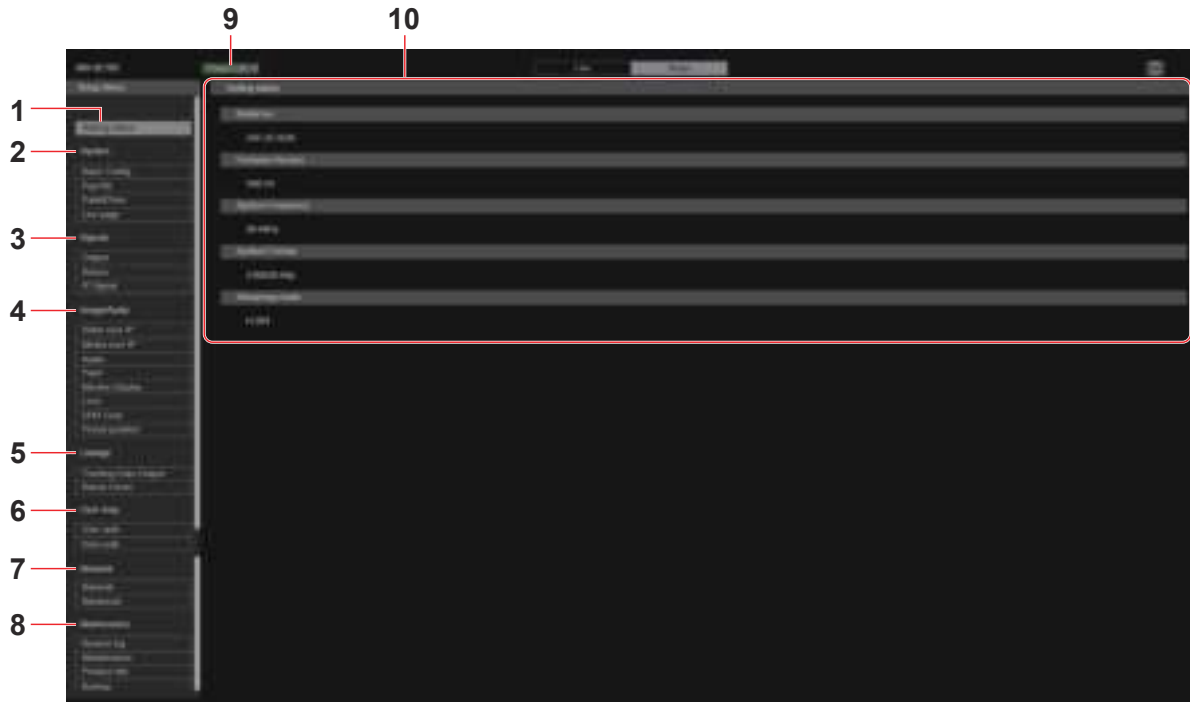

### 1. Setting status [Setting status]

The setting status screen [Setting status] is displayed when the button is clicked.

→ "Setting status screen [Setting status]" (→ page 112)

### 2. System settings [System]

#### Basic setting button [Basic Config]

The basic setting screen [Basic Config] is displayed when the button is clicked.

→ "Basic setting screen [Basic Config]" (→ page 112)

#### Pan/Tilt button [Pan/Tilt]

The Pan/Tilt settings screen [Pan/Tilt] is displayed when the button is clicked.

→ "Pan/Tilt settings screen [Pan/Tilt]" (→ page 117)

#### Date&Time button [Date&Time]

The Date & time screen [Date&Time] is displayed when the button is clicked.

→ "Date & time screen [Date&Time]" (→ page 118)

#### Live page button [Live page]

The live page screen [Live page] is displayed when the button is clicked.

→ "Live page screen [Live page]" (→ page 119)

### 3. Signal settings [Signals]

#### Output button [Output]

The output setting screen [Output] is displayed when the button is clicked.

→ "Output" (→ page 119)

#### Return button [Return]

The return setting screen [Return] is displayed when the button is clicked.

→ "Return" (→ page 123)

#### IP Signal button [IP SIGNAL]

The IP signal setting screen [IP SIGNAL] is displayed when the button is clicked.

→ "IP SIGNAL" (→ page 124)



### 4. Image screen [Image/Audio]

#### IP video settings button [Video over IP]

The IP video settings screen [Video over IP] is displayed when the button is clicked.

→ "IP video settings screen [Video over IP]" (→ page 125)

#### MoIP settings button [Media over IP]

The MoIP settings screen [Media over IP] is displayed when the button is clicked.

→ "MoIP settings screen [Media over IP]" (→ page 135)

#### Audio button [Audio]

The audio setting screen [Audio] is displayed when the button is clicked.

→ "Audio setting screen [Audio]" (→ page 140)

#### Paint settings button [Paint]

The paint settings screen [Paint] is displayed when the button is clicked.

→ "Paint settings screen [Paint]" (→ page 142)

#### Monitor display settings button [Monitor Display]

The monitor display settings screen [Monitor Display] is displayed when the button is clicked.

→ "Monitor display setting display [Monitor Display]" (→ page 156)

#### Lens button [Lens]

The Lens setting screen [Lens] is displayed when the button is clicked.

→ "Lens setting screen [Lens]" (→ page 157)

#### UHD crop button [UHD Crop]

The UHD crop setting screen [UHD Crop] is displayed when the button is clicked.

→ "UHD crop setting screen [UHD Crop]" (→ page 158)

#### Preset position button [Preset position]

The preset position screen [Preset position] is displayed when the button is clicked.

→ "Preset position screen [Preset position]" (→ page 160)

### 5. Collaboration capability [Linkage]

#### Tracking data output setting button [Tracking Data Output]

The tracking data output setting screen [Tracking Data Output] is displayed when the button is clicked.

→ "Tracking data output settings screen [Tracking Data Output]" (→ page 164)

#### Kairos Cloud connection setting button [Kairos Cloud]

Kairos Cloud connection setting screen [Kairos Cloud] is displayed when the button is clicked.

→ "Kairos Cloud connection setting screen [Kairos Cloud]" (→ page 166)

### 6. User management settings [User mng.]

#### User authentication button [User auth.]

The user authentication screen [User auth.] is displayed when the button is clicked.

→ "User authentication screen [User auth.]" (→ page 167)

#### Host authentication button [Host auth.]

The host authentication screen [Host auth.] is displayed when the button is clicked.

→ "Host authentication screen [Host auth.]" (→ page 168)

### 7. Network settings [Network]

#### Network setup button [Network]

The network setup screen [Network] is displayed when the button is clicked.

→ "Network setup screen [Network]" (→ page 169)

#### Advanced network setting button [Advanced]

The advanced network setting screen [Advanced] is displayed when the button is clicked.

→ "Advanced network setting screen [Advanced]" (→ page 172)

### 8. Maintenance [Maintenance]

#### System log button [System log]

The system log screen [System log] is displayed when the button is clicked.

→ "System log screen [System log]" (→ page 186)

#### Maintenance button [Maintenance]

The maintenance screen [Maintenance] is displayed when the button is clicked.

→ "Maintenance screen [Maintenance]" (→ page 187)

#### Product information button [Product Info.]

The product information screen [Product info.] is displayed when the button is clicked.



→ "Product information screen [Product info.]" (→ page 188)

#### Back up button [Backup]

The back up screen [Backup] is displayed when the button is clicked.

→ "Back up screen [Backup]" (→ page 189)

### 9. Power ON button [Power ON]/Standby button [Standby]

 Power ON	Turn the unit on.
 Standby	Set the unit to Standby mode.

When you enter Standby mode, the display will automatically switch to the live screen [Live]. In addition, the [Setup] button in the live screen [Live] will be disabled, and you cannot operate the web setup screen [Setup].

### 10. Main area

The menu screen is displayed.

**Setting status screen [Setting status]**

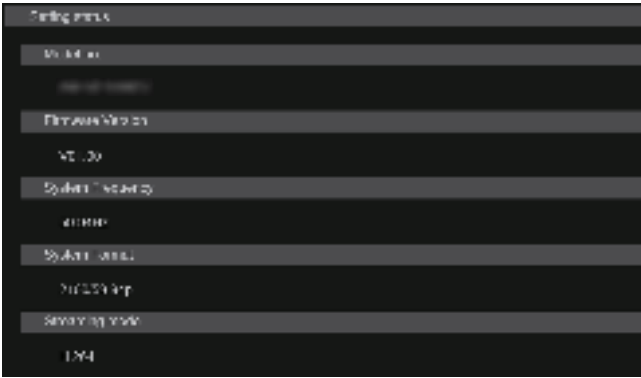

**Model no.**

The model number of the unit is displayed.

**Firmware Version**

The firmware version of the unit is displayed.  
Refer to the product information screen [Product info.] for detailed version information.

**System Frequency**

The frame frequency of the unit is displayed.

**System Format**

The video format of the unit is displayed.

**Streaming mode**

The streaming mode of the unit is displayed.

**System screen [System]**

■ **Basic setting screen [Basic Config]**

● **Setting status**



**Frequency**

The frame frequency setting is displayed.

**Format**

The video format setting is displayed.

● **Frequency**



**Frequency [60Hz, 59.94Hz, 50Hz, 24Hz, 23.98Hz]**

This item is selected to switch the frame frequency.  
The setting is confirmed with the [Set] button.

**Factory settings:** 59.94Hz

**<NOTE>**

- When the frame frequency is switched, the unit automatically restarts.



● **Format**

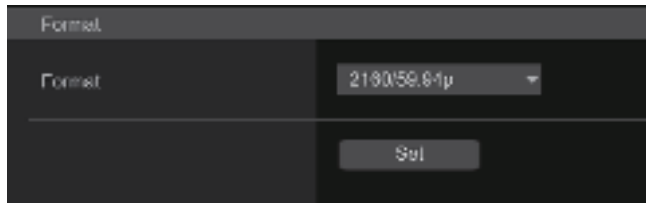

**Format**

**For [60Hz]**

2160/60p, 1080/60p

**For [59.94Hz]**

2160/59.94p, 2160/29.97p, 1080/119.88p, 1080/59.94p, 1080/29.97p, 720/59.94p

**For [50Hz]**

2160/50p, 2160/25p, 1080/100p, 1080/50p, 1080/25p, 720/50p

**For [24Hz]**

2160/24p, 1080/24p

**For [23.98Hz]**

2160/23.98p, 1080/23.98p

The video format is changed on this screen.  
The setting is confirmed with the [Set] button.

**<NOTE>**

- Streaming stops when changing the system format.
- For details on how to change the format, refer to “Changing the format” (→ page 51).
- In order to select [H.264(UHD)], [H.265(UHD)], [JPEG(UHD)], [RTMP(UHD)], [SRT(H.264 UHD)], and [SRT(H.265 UHD)] in [Streaming mode] for [Video over IP], you need to select the 4K format here.

● **SFP+ Mode**

Set the operating mode for the SFP+ connector.

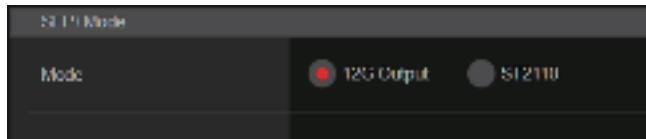

**SFP+ Mode [12G Output, ST2110]**

12G Output	The same video signal is output as the video output from the 12G SDI OUT connector.
ST2110	Video/Audio data that conforms with SMPTE ST2110 is output.

**Factory settings:** 12G Output

**<NOTE>**

- This unit automatically restarts when [SFP+ Mode] is changed.
- The following functions cannot be used when [12G Output] is selected:
  - SMPTE ST2110 video/audio output.
  - SMPTE ST2110 video input (RETURN) (→ page 136)
  - PTP synchronizing (→ page 138)

● **V-LOG**

The setting is confirmed with the [Set] button.



**V-LOG [Off, On]**

Set the V-LOG mode.

Off	This setting allows detailed picture quality adjustments on the camera.
On	Set a gamma curve that provides broad tones and a wide range of latitude (exposure range). Grading will be necessary after shooting.

**Factory settings:** Off

**<NOTE>**

- This cannot be set when the [Basic Config] – [HDR] is [On].
- Functions to adjust picture quality are limited when [Basic Config] – [V-LOG] is [On].

**V-LOG PAINT SW [Off, On]**

Selects whether to make it possible to make settings in the [PAINT] menu when [Basic Config] – [V-LOG] is [On].

**Factory settings:** Off

**<NOTE>**

- This cannot be set when the [Basic Config] – [V-LOG] is [Off].

● **HDR**

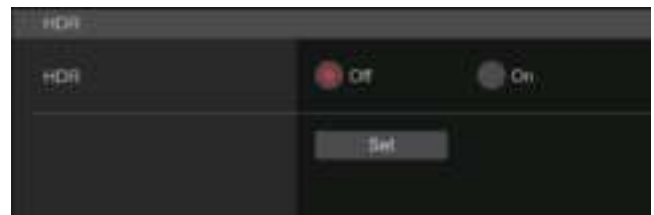

**HDR [On, Off]**

Enables/disables the HDR mode.  
The setting is confirmed with the [Set] button.

**Factory settings:** Off

**<NOTE>**

- This cannot be set when the [Basic Config] – [V-LOG] is [On].

## Web screen configurations (continued)

### ● GAMUT

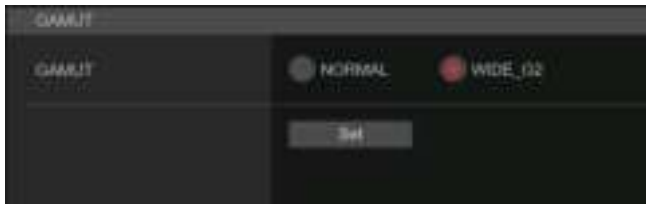

#### GAMUT [NORMAL, WIDE\_G2]

Sets the color gamut.

The setting is confirmed with the [Set] button.

NORMAL	BT.709 equivalent color gamut.
WIDE_G2	BT.2020 equivalent color gamut.

Factory settings: WIDE\_G2

<NOTE>

- This cannot be set when the [Basic Config] – [HDR] is [Off].

### ● SHOOTING MODE

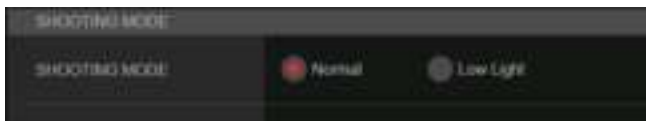

#### SHOOTING MODE [Normal, Low Light]

Select the shooting mode according to the shooting environment.

The setting is confirmed with the [Set] button.

Normal	Select this when shooting in an environment with normal brightness.
Low Light	Select this for high sensitivity shooting. (Suited to shooting in dark environments.)

Factory settings: Normal

### ● SERIAL CONNECTION



#### BAUD RATE [9600bps, 38400bps, 115200bps]

Set the communication speed (baud rate) for the RS-422 terminal connector.

Factory settings: 9600bps

<NOTE>

- This item is disabled when [Tracking Data Output] – [Serial] is [On].

### ● BAR







#### Bar [Off, On]

Off	Outputs camera images.
On	Outputs the color bar.

Factory settings: Off

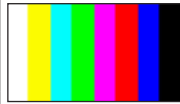
#### Color Bar Type [Type1, Type2, Type3, Type4, Type5]

Select the type of color bar to display.

Color Bar Type		Output color bar	
		IP transmissions (H.264/H.265/M-JPEG)	SDI/HDMI or SMPTE ST2110/High bandwidth NDI
Type1	SMPTE 	Type1	SDI/HDMI or SMPTE ST2110/High bandwidth NDI
			HD (720 or 1080)   UHD (2160)
Type1	SMPTE	Type1	SDI/HDMI
			Type1   Type1
Type1	SMPTE	Type1	SMPTE ST2110/High bandwidth NDI
			Type1   Type1
Type2	FULL 	Type2	SDI/HDMI
			Type2   Type2
Type2	FULL	Type2	SMPTE ST2110/High bandwidth NDI
			Type2   Type2
Type3	ARIB(FHD) 	Type1	SDI/HDMI
			Type3   Type3
Type3	ARIB(FHD)	Type1	SMPTE ST2110/High bandwidth NDI
			Type3   Type3
Type4	ARIB(UHD) 	Type1	SDI/HDMI
			Type3   Type4
Type4	ARIB(UHD)	Type1	SMPTE ST2110/High bandwidth NDI
			Type3   Type3
Type5	ARIB(2020/HLG) 	Type1	SDI/HDMI
			Type3   Type5
Type5	ARIB(2020/HLG)	Type1	SMPTE ST2110/High bandwidth NDI
			Type3   Type3

Factory settings: Type1

<NOTE>

- When [Bar] is [On], irrespective of the HDR/GAMUT/V-LOG setting values, color bars output are all [HDR] are [Off]/[V-LOG] are [Off] color bars.
- Color bars of IP transmissions (H.264/H.265/M-JPEG) do not conform with SMPTE.
- BAR ID (→ page 116) is not output with [Type4]/[Type5].
- With [Type4], 2020 is output even when set to 709.
- Type3/Type4/Type5 are not output with IP transmission modes (H.264/H.265/M-JPEG).
- Type4/Type5 are not output with SMPTE ST2110 and High bandwidth NDI.

## Web screen configurations (continued)

### Tone [Off, On]

Make the settings for the test tone signal (1 kHz) output while the color bar is displayed.

Off	Test tone is not output.
On	Test tone is output.

Factory settings: On

### ● TALLY



### Tally [Disable, Enable]

[Disable] or [Enable] is set here for the function which turns on or turns off the tally lamp using the tally control signal.

Factory settings: Enable

### Tally Brightness [Low, Mid, High]

Adjust the brightness of the tally LEDs.

Factory settings: Low

### Tally LED Limit

Sets whether to limit the lighting of the tally lamp for each of the tally control signal colors (R/G/Y).

#### R [Unlimit, Limit]

#### G [Unlimit, Limit]

#### Y [Unlimit, Limit]

Unlimit	Light the tally lamp.
Limit	Limit the lighting of the tally lamp.

Factory settings: Unlimit

#### <NOTE>

- If [Limit] is selected for [Tally LED Limit], only the tally lamp of this unit is limited. The tally status display on external devices (the AW-RP150, AW-RP60 controller, etc.) remains enabled.

### Tally Guard [Off, On]

The following functions are suppressed during input of only the R tally signal:

- Auto white balance and auto black balance operation
- OSD menu display
- OSD status indicators

Factory settings: Off

### External Output

Select the type of signal to be output from the External Output signal lines (Output1 and Output2) of the RS-422 connector. (→ page 20)

#### Output1 [Off, R-Tally, G-Tally, Y-Tally]

#### Output2 [Off, R-Tally, G-Tally, Y-Tally]

Off	Signal is not output.
R-Tally	The reception status of the red tally signal is output.
G-Tally	The reception status of the green tally signal is output.
Y-Tally	The reception status of the yellow tally signal is output.

Factory settings: Off

### ● SYNC SIGNAL

Make settings to synchronize video/audio output signals.

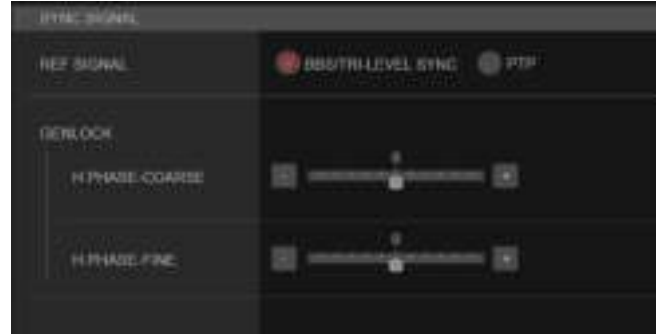

### REF SIGNAL

BBS/TRI-LEVEL SYNC	Synchronization is according to the SDI reference signal from the G/L connector.
PTP	Synchronization is according to the PTP from the SFP+ connector.

Factory settings: BBS/TRI-LEVEL SYNC

#### <NOTE>

- [PTP] cannot be selected when the SMPTE ST2110 upgrade key (AW-SFU60) is disabled.
- When [Basic Config] – [SFP+ Mode] is [12G Output], [PTP] cannot be selected.
- When [IP Signal] – [ST2110] – [MoIP Mode] is [Off], [PTP] cannot be selected.

### GENLOCK

This item is selected to perform the phase adjustments.

### H PHASE-COURSE [–5 to 5]

This is used to adjust the horizontal phase during genlock.

Factory settings: 0

### H PHASE-FINE [–100 to 100]

Make fine adjustments to horizontal phase in genlock.

Factory settings: 0

#### <NOTE>

- This cannot be set when the [Basic Config] – [Sync Signal] – [Ref Signal] is [PTP].

### ● BAR ID

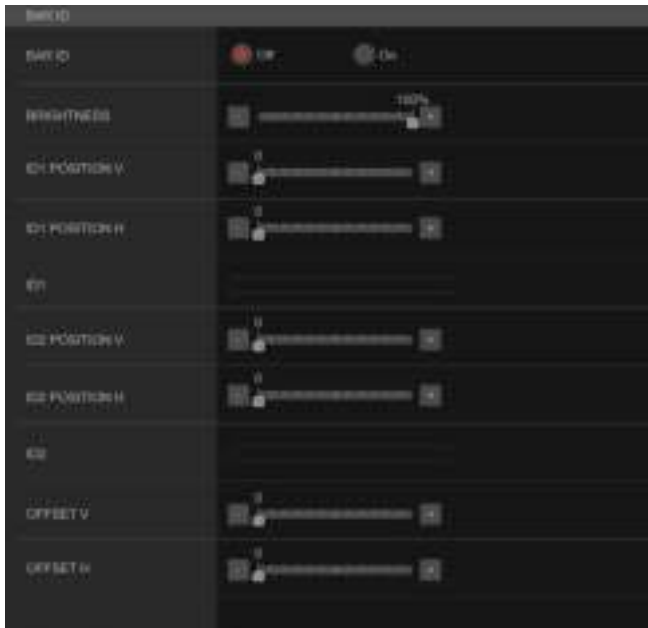

### OFFSET V [0 to 89]

Make fine adjustments to the display position of the [BAR ID] (offset position of the pixels in the font: vertically).

**Factory settings:** 0

### OFFSET H [0 to 79]

Make fine adjustments to the display position of the [BAR ID] (offset position of the pixels in the font: horizontally).

**Factory settings:** 0

### <NOTE>

- BAR ID is displayed only through the SDI, HDMI, SMPTE ST2110, and High bandwidth NDI outputs. It is not displayed with IP transmission (H.264/H.265/M-JPEG).

### BAR ID [Off, On]

Select Off/On for the ID display on the color bar.

**Factory settings:** Off

### BRIGHTNESS [0 to 100%]

Set the text color for the camera ID on the color bar.

**Factory settings:** 100%

### ID1 POSITION V [0 to 5]

Specify the font units for the start position for display of the camera ID1 (vertically: line number) on the color bar.

**Factory settings:** 0

### ID1 POSITION H [0 to 15]

Specify the font units for the start position for display of the camera ID1 (horizontally: column number) on the color bar.

**Factory settings:** 0

### ID1

Set the character string for the [BAR ID].

Maximum 16 characters

(Alphanumeric characters, spaces, ! # % & ' ( ) \* + , - . / : ; < = > ? [ ] \_ ~ \$ @ )

### ID2 POSITION V [0 to 5]

Specify the font units for the start position for display of the camera ID2 (vertically: line number) on the color bar.

**Factory settings:** 1

### ID2 POSITION H [0 to 15]

Specify the font units for the start position for display of the camera ID2 (horizontally: column number) on the color bar.

**Factory settings:** 0

### ID2

Set the character string for the [BAR ID].

Maximum 16 characters

(Alphanumeric characters, spaces, ! # % & ' ( ) \* + , - . / : ; < = > ? [ ] \_ ~ \$ @ )

### ■ Pan/Tilt settings screen [Pan/Tilt]

The setting is confirmed with the [Set] button.

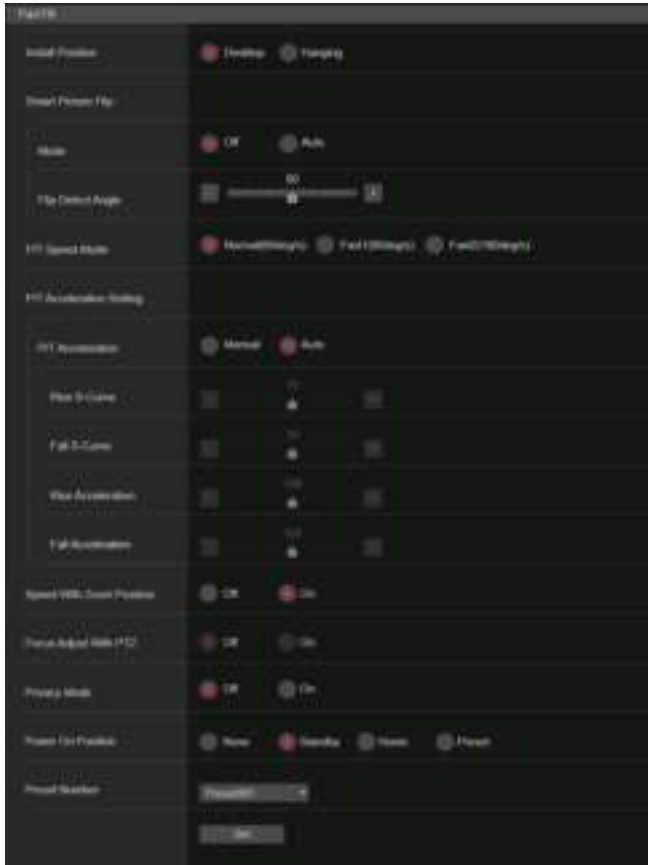

#### Install Position [Desktop, Hanging]

[Desktop] or [Hanging] is selected here as the method used to install the unit.

Desktop	Stand-alone installation
Hanging	Suspended installation

**Factory settings:** Desktop

**<NOTE>**

- When [Hanging] has been selected, the top, bottom, left and right of the images will be reversed, and up/down/left/right control for panning and tilting will also be reversed.

#### Smart Picture Flip

**Mode [Off, Auto]**

When the tilt becomes the angle set for [Flip Detect Angle], the image will be flipped in the vertical direction automatically.

Off	The picture is not turned upside down.
Auto	The picture is automatically turned upside down.

**Factory settings:** Off

#### Flip Detect Angle [60deg to 120deg]

Set the tilt angle at which the image will be flipped in the vertical direction automatically when [Smart Picture Flip] is set to [Auto].

**Factory settings:** 90deg

#### P/T Speed Mode

**[Normal(60deg/s), Fast1(90deg/s), Fast2(180deg/s)]**

Set the speed of pan/tilt operation.

Normal(60deg/s)	Pan/tilt operates at normal speed (maximum about 60° per second).
Fast1(90deg/s)	Pan/tilt operates at fast speed1 (maximum about 90° per second).
Fast2(180deg/s)	Pan/tilt operates at fast speed2 (maximum about 180° per second).

**Factory settings:** Normal(60deg/s)

#### P/T Acceleration Setting

Displays the advanced setting screen for setting the acceleration speed while starting/stopping a pan/tilt operation.

#### P/T Acceleration [Manual, Auto]

Sets whether to perform advance setting for acceleration and deceleration etc. during manual operation of pan/tilt.

Manual	Sets the advanced settings for acceleration speed etc. during start/stop or changing the speed of pan/tilt operation.
Auto	Sets the settings for automatic acceleration and deceleration speed etc. during start/stop or changing the speed of pan/tilt operations.

**Factory settings:** Auto

#### Rise S-Curve [0 to 30]

Sets the S-curve for pan/tilt acceleration operation in 31 steps. (The greater the number, the steeper the S-curve)

When it is necessary to increase the speed to the specified speed using manual control of pan/tilt by lever operation etc. through the controller, the acceleration process is performed based on the S-curve specified in this setting.

This is enabled only when [P/T Acceleration] is [Manual].

**Factory settings:** 15

**<NOTE>**

- In order to limit the acceleration response, in the S-curve step, as the acceleration speed rises, the limit is automatically applied.

#### Fall S-Curve [0 to 30]

Sets the S-curve for pan/tilt deceleration operation in 31 steps. (The greater the number, the steeper the S-curve)

When it is necessary to reduce the speed to the specified speed using manual control of pan/tilt by lever operation etc. through the controller, the deceleration process is performed based on the S-curve specified in this setting.

This is enabled only when [P/T Acceleration] is [Manual].

**Factory settings:** 15

**<NOTE>**

- In order to limit the deceleration response, in the S-curve step, as the deceleration speed rises, the limit is automatically applied.

#### Rise Acceleration [1 to 255]

Sets the acceleration speed for pan/tilt acceleration operation in 255 steps. (The acceleration speed increases as the number increases.)

When it is necessary to increase the speed to the specified speed using manual control of pan/tilt by lever operation etc. through the controller, the acceleration process is performed based on the acceleration speed specified in this setting.

This is enabled only when [P/T Acceleration] is [Manual].

**Factory settings:** 128

**<NOTE>**

- When the specified acceleration speed is small, it is not possible to reach the maximum speed of the product.

### Fall Acceleration [1 to 255]

Sets the deceleration speed for pan/tilt deceleration operation in 255 steps. (The deceleration speed increases as the number increases.) When it is necessary to reduce the speed to the specified speed using manual control of pan/tilt by lever operation etc. through the controller, the deceleration process is performed based on the deceleration speed specified in this setting.

This is enabled only when [P/T Acceleration] is [Manual].

**Factory settings:** 128

#### <NOTE>

- The deceleration and stop processes are carried out right up to the end of the lens mechanism section and in order to prevent a collision with the mechanism, in the actual operation, [Fall Acceleration] may be restricted.

### Speed With Zoom Position [Off, On]

[Off] or [On] is set here for the function used to adjust the pan/tilt adjustment speed in conjunction with the zoom magnification.

When [On] is set, the panning and tilting operations will become slower in the zoom status.

This function has no effect during preset operations.

**Factory settings:** On

### Focus Adjust With PTZ. [Off, On]

[Off] or [On] is set here for the function which compensates for out-of-focusing when it occurs during panning, tilting or zooming operations. When [Off] is set, adjust the focus as required after zooming or set [Focus Mode] to [Auto].

This is only enabled when [Manual] has been selected as the [Focus Mode] setting.

**Factory settings:** Off

### Privacy Mode [Off, On]

Sets Off/On the function for turning the camera direction down when this unit is changed to Standby mode.

Off	Does not change the camera direction when the camera is switched to Standby mode. (The camera direction from the Power On state is maintained)
On	Moves the camera to face toward the rear when the camera is switched to Standby mode. When the unit switches again to the Power On state, the unit moves to the position according to [Power On Position].

**Factory settings:** Off

### Power On Position [None, Standby, Home, Preset]

Select the initial positions for Pan/Tilt/Zoom when the power is turned on.

None	Maintains the Pan/Tilt position when the power is turned on, and Zoom will be at the Wide end.
Standby	Move to the Pan/Tilt/Zoom positions they were in the last time the camera was switched to Standby mode.
Home	Pan/Tilt move to their home positions (front) and Zoom goes to the Wide end.
Preset	Preset playback is performed at the preset position specified with [Preset Number].

**Factory settings:** Standby

### Preset Number [Preset001 to Preset100]

Specify a number for preset playback when the power turns ON when [Preset] is set in [Power On Position].

**Factory settings:** Preset001

#### <NOTE>

- If an unregistered preset number is set, preset playback is not performed and the operation is the same as [Standby].

## ■ Date & time screen [Date&Time]

Make clock settings.

You can set using one of three types [PC Synchronization], [NTP], or [Manual].

The setting is confirmed with the [Set] button.



### Auto

#### PC Synchronization

If you click the [Execute] button, the settings are configured by synchronizing the unit to the date and time of the connected personal computer.

#### <NOTE>

- The time zone of the personal computer is not reflected on the unit. Set the time zone on the unit.

#### NTP

If you click [NTP>>], the settings screen for the NTP server appears. (→ page 172)

### Manual

#### Date/Time

Configure the settings for the month, day, and year and for the hour, minute, and second.

#### <NOTE>

- The time is in the 24-hour format.

#### Time Zone

Selects the time zone according to the region where the camera is being used.

#### Factory settings:

(GMT) Greenwich Mean Time : Dublin, Edinburgh, Lisbon, London

■ Live page screen [Live page]



**Camera title**

Input the name of the camera here.

When the [Set] button is clicked, the input name appears in the camera title display area.

- The factory default setting is the model number of the unit.
- You can enter between 0 to 20 characters.
- The following characters can be displayed.

Numeric characters	0123456789
Alphabetical characters (upper and lower cases)	ABCDEFGHIJKLMNOPQRSTUVWXYZ abcdefghijklmnopqrstuvwxyz
Symbols	!#\$%&'()*+,-./:;<=>?@[^_`{ }~\

**Automatic installation of viewer software [On, Off]**

[Microsoft Edge \(I.E. Mode\)](#)

One of the following settings is selected for the automatic installation of the plug-in viewer software.

**Factory settings:** On

**Smoother live video display on the browser(buffering)**

**[On, Off]** [Microsoft Edge \(I.E. Mode\)](#)

Configure settings for displaying images from the unit on the plug-in viewer software.

On	Temporarily store images from the unit onto the personal computer for smoother display. However, the screen display images will be displayed later than the actual images.
Off	Do not temporarily store images from the unit onto the personal computer, and display them in real time. However, the motion of the screen display images may not be smooth.

**Factory settings:** On

■ Signal settings screen [Signal]

● Output

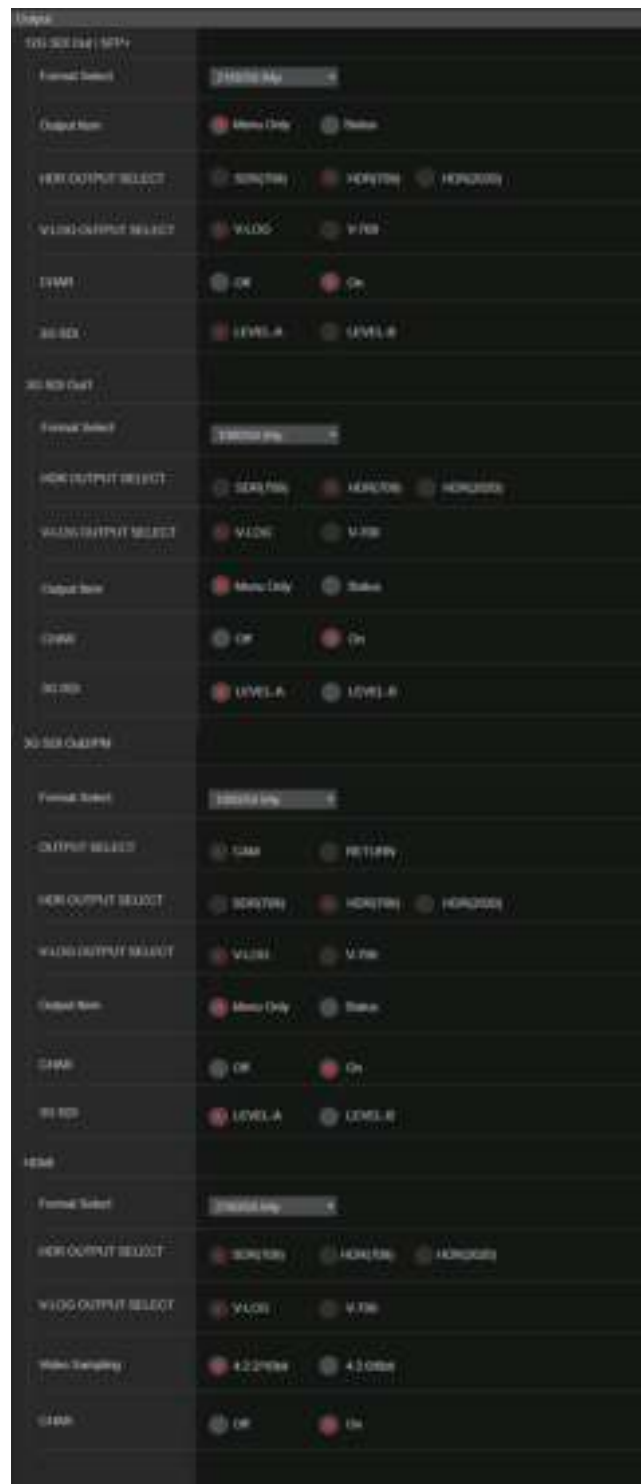



## Web screen configurations (continued)

### 12G SDI Out/SFP+

Make the settings for output from the 12G SDI OUT/SFP+ connector.

#### Format Select

Set the output format.

The following formats can be set depending on the settings in [Format] in [Basic Config].

Frequency	System Format	Format (12G SDI Out/SFP+)
60Hz	2160/60p	2160/60p 1080/60p
	1080/60p	1080/60p
59.94Hz	2160/59.94p	2160/59.94p 1080/59.94p*1
	2160/29.97p	2160/29.97p 1080/29.97p
	1080/119.88p	1080/59.94p*3
	1080/59.94p	1080/59.94p 1080/59.94i
	1080/29.97p	1080/29.97p
	720/59.94p	720/59.94p
50Hz	2160/50p	2160/50p 1080/50p*2
	2160/25p	2160/25p 1080/25p
	1080/100p	1080/50p*3
	1080/50p	1080/50p 1080/50i
	1080/25p	1080/25p
	720/50p	720/50p
24Hz	2160/24p	2160/24p 1080/24p
	1080/24p	1080/24p
23.98Hz	2160/23.98p	2160/23.98p 1080/23.98p
	1080/23.98p	1080/23.98p

\*1 When [UHD Crop] is [Crop(720)], output is 720/59.94p.

\*2 When [UHD Crop] is [Crop(720)], output is 720/50p.

\*3 For 119.88p (or 100p), "Frame 1" is output with the frame rate cut to half (59.94p (or 50p)).

**Factory settings:** 2160/59.94p or 2160/50p

#### Output Item [Menu Only, Status]

Select the type of OSD to be superimposed on output video.

Menu Only	Displays the OSD menu only.
Status	Displays the OSD menu and OSD status.

**Factory settings:** Menu Only

### HDR OUTPUT SELECT

#### [SDR(709), HDR(709), HDR(2020)]

Select the signal output when [HDR] is [On].

SDR(709)	Selects the SDR output signal.
HDR(709)	Selects the HDR output signal (BT.709 equivalent color gamut).
HDR(2020)	Selects the HDR output signal (BT.2020 equivalent color gamut).

**Factory settings:** HDR(2020)

<NOTE>

- This cannot be set when the [Basic Config] – [HDR] is [Off].
- [HDR(709)] can be selected only when [Basic Config] – [GAMUT] is [WIDE\_G2].

### V-LOG OUTPUT SELECT [V-LOG, V-709]

Select the signal output when [V-LOG] is [On].

V-LOG	Output with a gamma curve that has a wide range of tones and latitude (exposure range).
V-709	Converted for output to images suited to previewing.

**Factory settings:** V-LOG

<NOTE>

- This cannot be set when the [Basic Config] – [V-LOG] is [Off].

### CHAR [Off, On]

Set whether to superimpose the OSD.

**Factory settings:** On

### 3G SDI [LEVEL-A, LEVEL-B]

When [Format Select] (12G SDI Out/SFP+) is [1080/59.94p], [1080/60p] or [1080/50p], select the format for outputting 3G SDI signals.

**Factory settings:** LEVEL-A

<NOTE>

- [3G SDI] cannot be changed if [Format Select] (12G SDI Out/SFP+) is other than [1080/59.94p], [1080/60p] or [1080/50p].



## Web screen configurations (continued)

### 3G SDI Out1

Make the settings for output from the 3G SDI OUT1 connector.

### Format Select

Set the output format.

The following formats can be set depending on the settings in [Format] in [Basic Config].

Frequency	System Format	Format (3G SDI Out1)
60Hz	2160/60p	1080/60p
	1080/60p	1080/60p
59.94Hz	2160/59.94p	1080/59.94p*1 1080/59.94i*1
	2160/29.97p	1080/29.97p
	1080/119.88p	1080/59.94p*3
	1080/59.94p	1080/59.94p 1080/59.94i
	1080/29.97p	1080/29.97p
	720/59.94p	720/59.94p
50Hz	2160/50p	1080/50p*2 1080/50i*2
	2160/25p	1080/25p
	1080/100p	1080/50p*3
	1080/50p	1080/50p 1080/50i
	1080/25p	1080/25p
	720/50p	720/50p
24Hz	2160/24p	1080/24p
	1080/24p	1080/24p
23.98Hz	2160/23.98p	1080/23.98p
	1080/23.98p	1080/23.98p

\*1 When [UHD Crop] is [Crop(720)], output is 720/59.94p.

\*2 When [UHD Crop] is [Crop(720)], output is 720/50p.

\*3 For 119.88p (or 100p), "Frame 1" is output with the frame rate cut to half (59.94p (or 50p)).

**Factory settings:** 1080/59.94p or 1080/50p

### HDR OUTPUT SELECT

#### [SDR(709), HDR(709), HDR(2020)]

Select the signal output when [HDR] is [On].

SDR(709)	Selects the SDR output signal.
HDR(709)	Selects the HDR output signal (BT.709 equivalent color gamut).
HDR(2020)	Selects the HDR output signal (BT.2020 equivalent color gamut).

**Factory settings:** HDR(2020)

<NOTE>

- This cannot be set when the [Basic Config] – [HDR] is [Off].
- [HDR(2020)] can be selected only when [Basic Config] – [GAMUT] is [WIDE\_G2].

### V-LOG OUTPUT SELECT [V-LOG, V-709]

Select the signal output when [V-LOG] is [On].

V-LOG	Output with a gamma curve that has a wide range of tones and latitude (exposure range).
V-709	Converted for output to images suited to previewing.

**Factory settings:** V-LOG

<NOTE>

- This cannot be set when the [Basic Config] – [V-LOG] is [Off].

### Output Item [Menu Only, Status]

Select the type of OSD to be superimposed on output video.

Menu Only	Displays the OSD menu only.
Status	Displays the OSD menu and OSD status.

**Factory settings:** Menu Only

### CHAR [Off, On]

Set whether to superimpose the OSD.

**Factory settings:** On

### 3G SDI [LEVEL-A, LEVEL-B]

When [Format Select] (3G SDI Out1) is [1080/59.94p], [1080/60p] or [1080/50p], select the format for outputting 3G SDI signals.

**Factory settings:** LEVEL-A

<NOTE>

- [3G SDI] cannot be changed if [Format Select] (3G SDI Out1) is other than [1080/59.94p], [1080/60p] or [1080/50p].

## Web screen configurations (continued)

### 3G SDI Out2/PM

Make the settings for output from the 3G SDI OUT2/PM connector.

#### Format Select

Set the output format.

The following formats can be set depending on the settings in [Format] in [Basic Config].

Frequency	System Format	Format (3G SDI Out2/PM)
60Hz	2160/60p	1080/60p
	1080/60p	1080/60p
59.94Hz	2160/59.94p	1080/59.94p* <sup>1</sup> 1080/59.94i* <sup>1</sup>
	2160/29.97p	1080/29.97p
	1080/119.88p	1080/59.94p* <sup>3</sup>
	1080/59.94p	1080/59.94p 1080/59.94i
	1080/29.97p	1080/29.97p
	720/59.94p	720/59.94p
50Hz	2160/50p	1080/50p* <sup>2</sup> 1080/50i* <sup>2</sup>
	2160/25p	1080/25p
	1080/100p	1080/50p* <sup>3</sup>
	1080/50p	1080/50p 1080/50i
	1080/25p	1080/25p
	720/50p	720/50p
24Hz	2160/24p	1080/24p
	1080/24p	1080/24p
23.98Hz	2160/23.98p	1080/23.98p
	1080/23.98p	1080/23.98p

\*<sup>1</sup> When [UHD Crop] is [Crop(720)], output is 720/59.94p.

\*<sup>2</sup> When [UHD Crop] is [Crop(720)], output is 720/50p.

\*<sup>3</sup> For 119.88p (or 100p), "Frame 2" is output with the frame rate cut to half (59.94p (or 50p)).

**Factory settings:** 1080/59.94p or 1080/50p

#### OUTPUT SELECT [CAM, RETURN]

Switch between outputting the camera images and the images received through RETURN (images input through SMPTE ST2110).

CAM	Outputs camera input images.
RETURN	Outputs images received through RETURN (SMPTE ST2110 input images).

#### <NOTE>

- This cannot be set when [Basic Config] – [Format] is other than [1080/59.94p] or [1080/50p].
- This cannot be set when the [Basic Config] – [SFP+ Mode] is [12G Output].
- This cannot be set when [Crop] – [UHD Crop] is [Crop(720)] or [Crop(1080)].
- This cannot be set when the [Image/Audio] – [Media over IP] – [ST2110] is [Off].
- This item cannot be set if the SMPTE ST2110 software key (AW-SFU60) is disabled.

### HDR OUTPUT SELECT

#### [SDR(709), HDR(709), HDR(2020)]

Select the signal output when [HDR] is [On].

SDR(709)	Selects the SDR output signal.
HDR(709)	Selects the HDR output signal (BT.709 equivalent color gamut).
HDR(2020)	Selects the HDR output signal (BT.2020 equivalent color gamut).

**Factory settings:** HDR(2020)

#### <NOTE>

- This cannot be set when the [Basic Config] – [HDR] is [Off].
- [HDR(2020)] can be selected only when [Basic Config] – [GAMUT] is [WIDE\_G2].

### V-LOG OUTPUT SELECT [V-LOG, V-709]

Select the signal output when [V-LOG] is [On].

V-LOG	Output with a gamma curve that has a wide range of tones and latitude (exposure range).
V-709	Converted for output to images suited to previewing.

**Factory settings:** V-LOG

#### <NOTE>

- This cannot be set when the [Basic Config] – [V-LOG] is [Off].

### Output Item [Menu Only, Status]

Select the type of OSD to be superimposed on output video.

Menu Only	Displays the OSD menu only.
Status	Displays the OSD menu and OSD status.

**Factory settings:** Menu Only

### CHAR [Off, On]

Set whether to superimpose the OSD.

**Factory settings:** On

### 3G SDI [LEVEL-A, LEVEL-B]

When [Format Select] (3G SDI Out2/PM) is [1080/59.94p], [1080/60p] or [1080/50p], select the format for outputting 3G SDI signals.

**Factory settings:** LEVEL-A

#### <NOTE>

- [3G SDI] cannot be changed if [Format Select] (3G SDI Out2/PM) is other than [1080/59.94p], [1080/60p] or [1080/50p].

## Web screen configurations (continued)

### HDMI

Make the settings for output from the HDMI connector.

#### Format Select

Set the output format.

The following formats can be set depending on the settings in [Format] in [Basic Config].

Frequency	System Format	Format (HDMI)
60Hz	2160/60p	2160/60p 1080/60p
	1080/60p	1080/60p
59.94Hz	2160/59.94p	2160/59.94p 1080/59.94p*1
	2160/29.97p	2160/29.97p 1080/29.97p
	1080/119.88p	1080/119.88p
	1080/59.94p	1080/59.94p 1080/59.94i
	1080/29.97p	1080/29.97p
	720/59.94p	720/59.94p
50Hz	2160/50p	2160/50p 1080/50p*2
	2160/25p	2160/25p 1080/25p
	1080/100p	1080/100p
	1080/50p	1080/50p 1080/50i
	1080/25p	1080/25p
	720/50p	720/50p
24Hz	2160/24p	2160/24p 1080/24p
	1080/24p	1080/24p
23.98Hz	2160/23.98p	2160/23.98p 1080/23.98p
	1080/23.98p	1080/23.98p

\*1 When [UHD Crop] is [Crop(720)], output is 720/59.94p.

\*2 When [UHD Crop] is [Crop(720)], output is 720/50p.

**Factory settings:** 2160/59.94p or 2160/50p

### HDR OUTPUT SELECT

#### [SDR(709), HDR(709), HDR(2020)]

Select the signal output when [HDR] is [On].

SDR(709)	Selects the SDR output signal.
HDR(709)	Selects the HDR output signal (BT.709 equivalent color gamut).
HDR(2020)	Selects the HDR output signal (BT.2020 equivalent color gamut).

**Factory settings:** HDR(2020)

#### <NOTE>

- This cannot be set when the [Basic Config] – [HDR] is [Off].
- [HDR(2020)] can be selected only when [Basic Config] – [GAMUT] is [WIDE\_G2].

### V-LOG OUTPUT SELECT [V-LOG, V-709]

Select the signal output when [V-LOG] is [On].

V-LOG	Output with a gamma curve that has a wide range of tones and latitude (exposure range).
V-709	Converted for output to images suited to previewing.

**Factory settings:** V-LOG

#### <NOTE>

- This cannot be set when the [Basic Config] – [V-LOG] is [Off].

### Video Sampling [4:2:2/10bit, 4:2:0/8bit]

When [Format Select] in [HDMI] is [2160/59.94p], [2160/60p] or [2160/50p], select the video sampling output from the HDMI connector.

**Factory settings:** 4:2:2/10bit

#### <NOTE>

- When [Format Select] in [HDMI] is other than [2160/59.94p], [2160/60p] or [2160/50p], [Video Sampling] cannot be changed and is fixed at [4:2:2/10bit].

### CHAR [Off, On]

Set whether to superimpose the OSD.

**Factory settings:** On

### Return

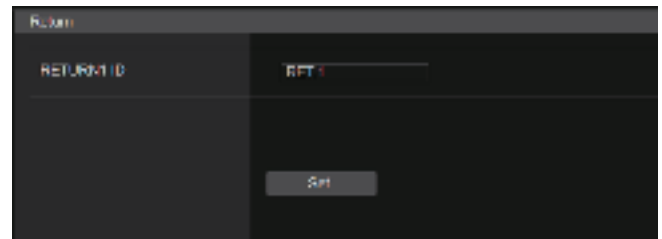

### RETURN1 ID

You can give a name to the return images (SMPTE ST2110 input images).

It can be 5 characters.

Alphanumeric characters, spaces, ! # % & ' ( ) \* + , - . / : ; < = > ? [ ] \_ ~ \$ @ |

The setting is confirmed with the [Set] button.

The name you set is superimposed on the images output from the same connector when [RETURN] is selected in [OUTPUT] – [3G SDI OUT2/PM] – [OUTPUT SELECT].

#### <NOTE>

- This item cannot be set if the SMPTE ST2110 software key (AW-SFU60) is disabled.

## Web screen configurations (continued)

### ● IP SIGNAL

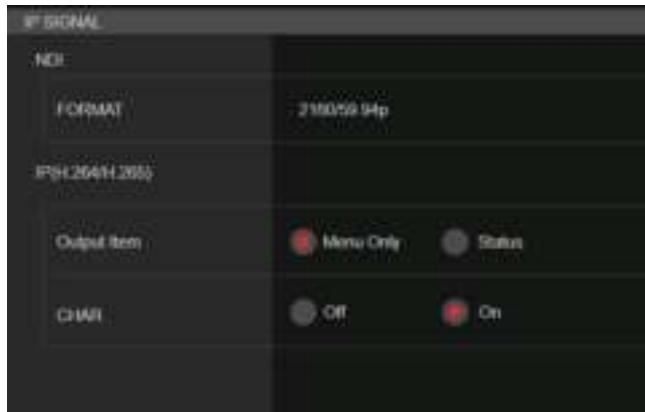

### NDI

Make a variety of settings related to High bandwidth NDI images.

#### FORMAT

Set the output format.

Frequency	System Format	Format (NDI)
60Hz	2160/60p	2160/60p* <sup>9</sup> 1080/60p
	1080/60p	1080/60p
59.94Hz	2160/59.94p	2160/59.94p* <sup>1, 2</sup> 1080/59.94p
	2160/29.97p	2160/29.97p* <sup>3</sup> 1080/29.97p
	1080/119.88p	1080/59.94p* <sup>10</sup>
	1080/59.94p	1080/59.94p
	1080/29.97p	1080/29.97p
	720/59.94p	720/59.94p
50Hz	2160/50p	2160/50p* <sup>4, 5</sup> 1080/50p
	2160/25p	2160/25p* <sup>6</sup> 1080/25p
	1080/100p	1080/50p* <sup>10</sup>
	1080/50p	1080/50p
	1080/25p	1080/25p
	720/50p	720/50p
24Hz	2160/24p	2160/24p* <sup>7</sup> 1080/24p
	1080/24p	1080/24p
23.98Hz	2160/23.98p	2160/23.98p* <sup>8</sup> 1080/23.98p
	1080/23.98p	1080/23.98p

\*1 When [UHD Crop] is [Crop(1080)], output is 1080/59.94p.

\*2 When [UHD Crop] is [Crop(720)], output is 720/59.94p.

\*3 When [UHD Crop] is [Crop(1080)], output is 1080/29.97p.

\*4 When [UHD Crop] is [Crop(1080)], output is 1080/50p.

\*5 When [UHD Crop] is [Crop(720)], output is 720/50p.

\*6 When [UHD Crop] is [Crop(1080)], output is 1080/25p.

\*7 When [UHD Crop] is [Crop(1080)], output is 1080/24p.

\*8 When [UHD Crop] is [Crop(1080)], output is 1080/23.98p.

\*9 When [UHD Crop] is [Crop(1080)], output is 1080/60p.

\*10 For 119.88p (or 100p), "Frame 1" is output with the frame rate cut to half (59.94p (or 50p)).

**Factory settings:** 2160/59.94p or 2160/50p

### IP(H.264/H.265)

Make a variety of settings related to IP video transmission (H.264/H.265/M-JPEG).

#### Output Item [Menu Only, Status]

Select the type of OSD to be superimposed on output video.

Menu Only	Displays the OSD menu only.
Status	Displays the OSD menu and OSD status.

**Factory settings:** Menu Only

#### CHAR [Off, On]

Set whether to superimpose the OSD.

**Factory settings:** On

#### <NOTE>

- During IP video transmission (H.264/H.265/M-JPEG), there may be some delays in OSD menu operations. Smooth OSD menu operations become possible when you set this item to [Off].

Image screen [Image/Audio]

■ IP video settings screen [Video over IP]

The JPEG image and H.264 image settings as well as the settings related to image quality are selected on this screen.

<NOTE>

- IP control can be performed but if you do not want to perform IP image transmission, set [JPEG transmission], [H.264 transmission], [H.265 transmission], [RTMP transmission], [SRT transmission] and [TS transmission] to [Off].
- If JPEG image transmission is set to [Off], IP images cannot be displayed in browsers other than Microsoft Edge (IE mode). This includes mobile terminals.
- During IP video transmission, disconnecting the network cable connected to this unit or changing the network settings may cause the transmission to stop.

● Setting status

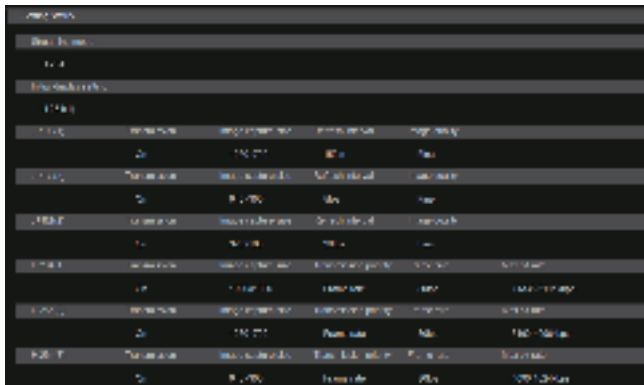

Streaming mode

The streaming mode setting is displayed.

Initial display setting

The setting for the image displayed when the live screen [Live] is open.

JPEG

The JPEG transmission settings are displayed.

H.264

The H.264 transmission settings are displayed. These are not displayed when [Streaming mode] is [H.265], [H.265(UHD)], [SRT(H.265)] or [SRT(H.265 UHD)].

H.265

The H.265 transmission settings are displayed. These are displayed when [Streaming mode] is [H.265], [H.265(UHD)], [SRT(H.265)] or [SRT(H.265 UHD)].

● Streaming mode

It is possible to perform IP transmission operations suited to the application by switching the [Streaming mode] on this unit. The setting is confirmed with the [Set] button.

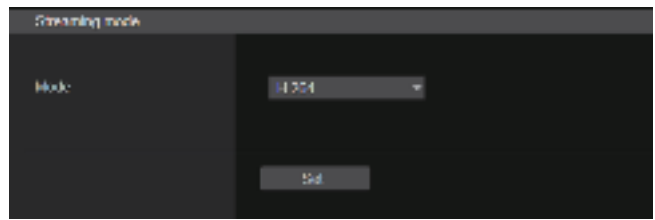

Mode [H.264(UHD), H.264, H.265(UHD), H.265, JPEG(UHD), RTMP, RTMP(UHD), SRT(H.264), SRT(H.264 UHD), SRT(H.265), SRT(H.265 UHD), NDI|HX V2, NDI|HX V2(UHD), MPEG2-TS over UDP, High bandwidth NDI]

H.264(UHD)	IP videos can be transmitted over multiple channels. 4K images are transmitted via IP in the H.264 format. <ul style="list-style-type: none"> <li>• 4K images in H.264 format cannot be displayed in the live screen [Live] of the unit. Use external devices and software compatible with 4K images to display 4K images.</li> </ul>
H.264	IP videos can be transmitted over multiple channels. Full HD images are transmitted via IP in the H.264 format.
H.265(UHD)	IP videos can be transmitted over multiple channels. 4K images are transmitted via IP in the H.265 format. <ul style="list-style-type: none"> <li>• 4K images in H.265 format cannot be displayed in the live screen [Live] of the unit. Use external devices and software compatible with 4K images to display 4K images.</li> </ul>
H.265	IP videos can be transmitted over multiple channels. Full HD images are transmitted via IP in the H.265 format.
JPEG(UHD)	IP videos can be transmitted over multiple channels. 4K images are transmitted via IP in the JPEG format.
RTMP	Full HD images are transmitted via IP in the H.264 format to the RTMP/RTMPS server.
RTMP(UHD)	4K images are transmitted via IP in the H.264 format to the RTMP/RTMPS server.
SRT(H.264)	Full HD images are transmitted via IP in the H.264 format to the SRT compatible decoder or service.
SRT(H.264 UHD)	4K images are transmitted via IP in the H.264 format to the SRT compatible decoder or service.
SRT(H.265)	Full HD images are transmitted via IP in the H.265 format to the SRT compatible decoder or service.
SRT(H.265 UHD)	4K images are transmitted via IP in the H.265 format to the SRT compatible decoder or service.
NDI HX V2/ NDI HX V2(UHD)	Videos are sent to software applications and hardware compatible with NewTek NDI HX over a network.
MPEG2-TS over UDP	IP videos can be transmitted over multiple channels. Full HD images are transmitted via IP in the H.264 format.
High bandwidth NDI	Videos are sent to software applications and hardware compatible with NewTek High Bandwidth NDI over a network.

Factory settings: H.264

<NOTE>

- When [IP(UDP)] of [Tracking Data Output] is set to [On], video transmission via IP may be delayed or the video may suffer frame loss. (→ page 165)  
We recommend setting [IP(UDP)] of [Tracking Data Output] to [Off] to avoid the delay or frame loss due to the video transmission via IP.

## Web screen configurations (continued)

### ● Initial display setting

Set initial display settings for the Live screen [Live].  
The setting is confirmed with the [Set] button.

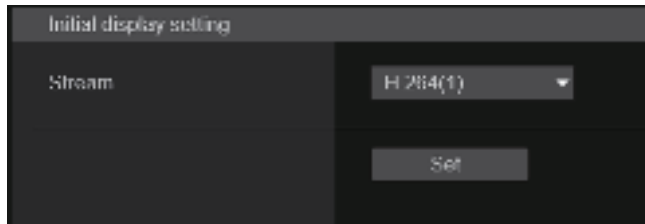

### Stream [H.264(1), H.264(2), H.264(3), JPEG(1), JPEG(2), JPEG(3)]

Select the type of images to display in the Live screen [Live].

H.264(1) Microsoft Edge (I.E. Mode)	Display videos (H.264(1)).
H.264(2) Microsoft Edge (I.E. Mode)	Display videos (H.264(2)).
H.264(3) Microsoft Edge (I.E. Mode)	Display videos (H.264(3)).
JPEG(1)	Display still images (JPEG(1)).
JPEG(2)	Display still images (JPEG(2)).
JPEG(3)	Display still images (JPEG(3)).

**Factory settings:** H.264(1)

#### <NOTE>

- This setting may switch automatically according to the [Streaming mode].

### ● Timecode Overlay

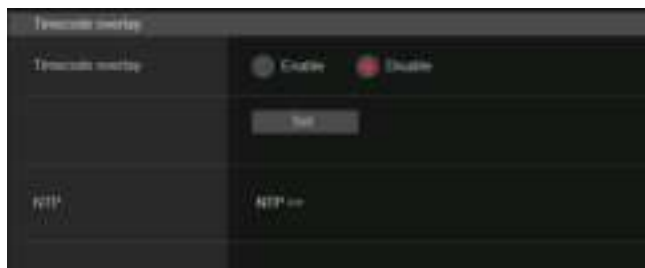

### Timecode Overlay [Enable, Disable]

Set whether timecode information is overlaid on IP transmission data.

**Factory settings:** Disable

#### <NOTE>

- This function can be set only when NTP is enabled.
- This function overlays the time information synchronized with NTP.

### ● JPEG

Set JPEG image settings.

The setting is confirmed with the [Set] button.

There are a total of 3 channels available for JPEG image setting.

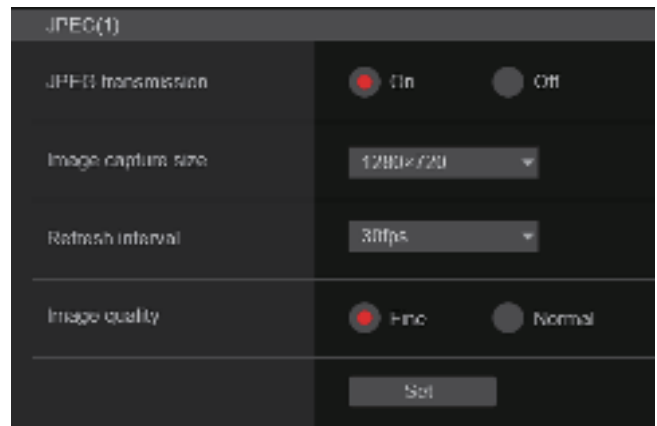

#### <NOTE>

- [JPEG(2)] and [JPEG(3)] cannot be set when the [Streaming mode] is [JPEG(UHD)], [NDI|HX V2] or [High bandwidth NDI].

### JPEG transmission [On, Off]

Set whether to transmit JPEG images.

**Factory settings:** On

### Image capture size [3840×2160, 1920×1080, 1280×720, 640×360, 320×180]

When displaying JPEG images, select the resolution for image display from the following.

JPEG(1)	3840×2160, 1920×1080, 1280×720, 640×360, 320×180
JPEG(2)	640×360, 320×180
JPEG(3)	640×360, 320×180

#### Factory settings:

JPEG(1): 1280×720

JPEG(2): 640×360

JPEG(3): 320×180

#### <NOTE>

- [3840 x 2160] can be selected when the [Streaming mode] is [JPEG(UHD)].

**Refresh interval [1fps, 4fps, 5fps, 12fps, 12.5fps, 15fps, 24fps, 25fps, 30fps]**

Select the frame rate for JPEG images.

59.94Hz	1fps/5fps/15fps/30fps
50Hz	1fps/5fps/12.5fps/25fps
24/23.98Hz	1fps/4fps/12fps/24fps

**Factory settings:**

For 59.94Hz:

JPEG(1): 30fps

JPEG(2): 5fps

JPEG(3): 30fps

For 50Hz:

JPEG(1): 25fps

JPEG(2): 5fps

JPEG(3): 25fps

For 24/23.98Hz:

JPEG(1): 24fps

JPEG(2): 4fps

JPEG(3): 24fps

**<NOTE>**

- The frame rate may be slower depending on the network environment, resolution, image quality, access volume, etc.
- If images are not transmitted at the specified frame rate, lowering the resolution or image quality may result in transmissions closer to the specified value.

**Image quality [Fine, Normal]**

Specify the JPEG image quality for each resolution.

**Factory settings:** Fine

**● H.264**

Set H.264 image settings.

The setting is confirmed with the [Set] button.



**<NOTE>**

- Only JPEG images can be displayed in browsers other than Microsoft Edge (IE mode).
- Only [H.264(1)] can be set when the [Streaming mode] is [H.264(UHD)].
- H.264 cannot be set when the [Streaming mode] is [H.265(UHD)], [H.265], [SRT(H.265)], [SRT(H.265 UHD)], [NDI|HX V2], [NDI|HX V2(UHD)] or [High bandwidth NDI].
- When starting RTSP/RTP transmissions, set the following URLs for the decoders and applications.
  - For H.264(1):  
rtsp://[unit's IP address]/MediaInput/h264/stream\_1
  - For H.264(2):  
rtsp://[unit's IP address]/MediaInput/h264/stream\_2
  - For H.264(3):  
rtsp://[unit's IP address]/MediaInput/h264/stream\_3

[/MediaInput/h264/stream\_\*] can be changed in [RTSP] of [Advanced]. (→ page 175)

**H.264 transmission [On, Off]**

Whether to transmit the H.264 images is set here.

**Factory settings:** On

**Internet mode(Over HTTP) [On, Off]**

This setting is selected when transmitting H.264 images over the Internet.

H.264 images can be transmitted using the same broadband router settings as when transmitting JPEG images.

On	The H.264 images and audio are transmitted using the HTTP port. For details on setting the HTTP port number, refer to page 171.
Off	The H.264 images and audio are transmitted using the UDP port.

**Factory settings:** Off

**<NOTE>**

- The transmission format is restricted to [Unicast port(AUTO)] when this is set to [On].
- When [On] is set, it takes a few seconds before the H.264 images are displayed.
- When this is set to [On], access will be limited to IPv4.
- This function is only reflected in the H.264 images displayed in the live screen [Live].

**Profile type [High, Main, Baseline]**

Set the profile for when H.264 images are transmitted.

**Factory settings:** High



## Web screen configurations (continued)

### Image capture size

#### [3840×2160, 1920×1080, 1280×720, 640×360]

Select the resolution for H.264 images.

Selectable options will vary depending on the selected resolution setting.

H.264(1)	3840×2160, 1920×1080, 1280×720
H.264(2)	1920×1080, 1280×720, 640×360
H.264(3)	1280×720, 640×360

#### Factory settings:

H.264(1): 1920×1080

H.264(2): 1280×720

H.264(3): 640×360

#### <NOTE>

- [3840×2160] can be selected when the [Streaming mode] is [H.264(UHD)].

### CBR/VBR [CBR, VBR]

Set the transmission mode for H.264 images.

CBR	Transmit with the bit rate set for H.264 images.
VBR	Transmit with the bit rate set for H.264 images and also vary the bit rate according to the images to be recorded.

#### Factory settings: VBR

### Frame rate [24fps, 25fps, 30fps, 50fps, 60fps]

Set the frame rate for H.264 images.

59.94Hz	30fps/60fps
50Hz	25fps/50fps
24/23.98Hz	24fps

#### Factory settings:

For 59.94Hz: 30fps

For 50Hz: 25fps

For 24/23.98Hz: 24fps

#### <NOTE>

- [60fps(50fps)] cannot be selected when the video format is [29.97p(25p)].

### Max bit rate(per client)

#### [2048kbps, 4096kbps, 8192kbps, 10240kbps, 12800kbps, 14336kbps, 20480kbps, 24576kbps, 25600kbps, 51200kbps, 76800kbps]

Specify the H.264 bit rate per client.

#### Factory settings:

H.264(1): 14336kbps

H.264(2): 8192kbps

H.264(3): 4096kbps

#### <NOTE>

- The setting range depends on the resolution.

### Transmission type [Unicast port(AUTO), Unicast port(MANUAL), Multicast]

Select the transmission format for H.264 images.

Unicast port(AUTO)	Up to 14 users can access a single camera at the same time. [Unicast port(Image)] and [Unicast port(Audio)] will be configured automatically when images and audio are sent from the camera. We recommend selecting the [Unicast port(AUTO)] setting when the port number transmitting the H.264 images does not need to be fixed (e.g., during use within a network).
Unicast port(MANUAL)	Up to 14 users can access a single camera at the same time. [Unicast port(Image)] and [Unicast port(Audio)] must be configured manually when images and audio are sent from the camera. When transmitting H.264 images via the Internet, configure a fixed transmission port for the broadband router (hereafter referred to as "router") (→ page 169). For details, refer to the operating instructions for the router.
Multicast	An unlimited number of users can access a single camera at the same time. When transmitting H.264 images via multicast, enter the [Multicast address], [Multicast port], and [Multicast TTL/HOPLimit].

#### Factory settings: Unicast port(AUTO)

#### <NOTE>

- For details on the maximum number for simultaneous access, see <NOTE> (→ page 102).

### Unicast port(Image) [1024 to 50000]

Enter the unicast port number (used when sending images from the unit).

Only even numbers can be specified.

The port number cannot be set to 10670.

#### Factory settings:

H.264(1): 32004

H.264(2): 32014

H.264(3): 32024

### Unicast port(Audio) [1024 to 50000]

Only even numbers can be specified.

The port number cannot be set to 10670.

#### Factory settings:

H.264(1): 33004

H.264(2): 33014

H.264(3): 33024

#### <NOTE>

- If [Unicast port(MANUAL)] is selected as the [Transmission type], the unicast port number needs to be set.

### Multicast address

#### [IPv4: 224.0.0.0 to 239.255.255.255]

#### IPv6: Multicast address starting with FF]

Enter the multicast IP address.

Images and audio will be sent to the specified IP address.

#### Factory settings:

H.264(1): 239.192.0.20

H.264(2): 239.192.0.21

H.264(3): 239.192.0.22

#### <NOTE>

- Verify usable multicast IP addresses before entering this setting.
- This setting does not work with the multicast address for link local scope.



### Multicast port [1024 to 50000]

Enter the multicast port number (used when sending images from the unit).

Only even numbers can be specified.

The port number cannot be set to 10670.

**Factory settings:** 37004

<NOTE>

- When sending audio from the unit, a port number with "1000" added to the multicast port number will be used.

### Multicast TTL/HOPLimit [1 to 254]

Enter the TTL/HOPLimit value for multicast.

**Factory settings:** 16

<NOTE>

- When transmitting H.264 images via the Internet, transmitted images may not appear depending on proxy server settings, firewall settings, etc. In such cases, consult your network administrator.
- When displaying multicast images on a personal computer with multiple LAN cards installed, disable the LAN cards that are not used for reception.

### ● H.265

Set H.265 image settings.

The setting is confirmed with the [Set] button.



<NOTE>

- H.265 format images cannot be displayed in the live screen [Live] of the unit.
- Use external devices and software compatible with H.265 images to display H.265 images.
- When starting RTSP/RTP transmissions, set the following URLs for the decoders and applications.
  - For H.265(1):  
rtsp://[unit's IP address]/MediaInput/h265/stream\_1
  - For H.265(2):  
rtsp://[unit's IP address]/MediaInput/h265/stream\_2

[/MediaInput/h265/stream\_\*] can be changed in [RTSP] of [Advanced]. (→ page 175)

### H.265 transmission [On, Off]

Whether to transmit the H.265 images is set here.

**Factory settings:** On

### Image capture size [3840×2160, 1920×1080, 1270×720, 640×360]

Select the resolution for H.265 images.

Selectable options will vary depending on the selected resolution setting.

H.265(1)	3840×2160, 1920×1080, 1270×720
H.265(2)	1920×1080, 1270×720, 640×360

**Factory settings:**

H.265(1): 1920×1080

H.265(2): 1280×720

<NOTE>

- [3840×2160] can be selected when the [Streaming mode] is [H.265(UHD)].

## Web screen configurations (continued)

### CBR/VBR [CBR, VBR]

Set the transmission mode for H.265 images.

CBR	Transmit with the bit rate set for H.265 images.
VBR	Transmit with the bit rate set for H.265 images and also vary the bit rate according to the images to be recorded.

Factory settings: VBR

### Frame rate [24fps, 25fps, 30fps, 50fps, 60fps]

Set the frame rate for H.265 images.

59.94Hz	30fps, 60fps
50Hz	25fps, 50fps
24/23.98Hz	24fps

Factory settings:

For 59.94Hz: 30fps

For 50Hz: 25fps

For 24/23.98Hz: 24fps

<NOTE>

- [60fps(50fps)] cannot be selected when the video format is [29.97p(25p)].

### Max bit rate(per client)

**[2048kbps, 4096kbps, 8192kbps, 10240kbps, 12800kbps, 14336kbps, 20480kbps, 24576kbps, 25600kbps, 51200kbps, 76800kbps]**

Specify the H.265 bit rate per client.

Factory settings:

H.265(1): 14336kbps

H.265(2): 8192kbps

### Transmission type

The same as [H.264] [Transmission type] (→ page 128).

Unicast port(Image)	The same as [H.264] [Unicast port(Image)] (→ page 128).
Unicast port(Audio)	The same as [H.264] [Unicast port(Audio)] (→ page 128).

### Multicast address

The same as [H.264] [Multicast address] (→ page 128).

### Multicast port

The same as [H.264] [Multicast port] (→ page 129).

### Multicast TTL/HOPLimit

The same as [H.264] [Multicast TTL/HOPLimit] (→ page 129).

## ● RTMP

Make RTMP/RTMPS transmission settings.

### Server setup

The setting is confirmed with the [Set] button.

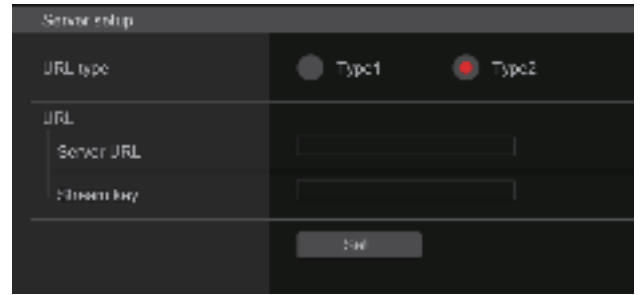

<NOTE>

- Switch to the appropriate method of registering RTMP/RTMPS transmission server information suited to the setting information notified from the RTMP/RTMPS transmission server you are using.
- The Stream Key setting field is displayed only when [Type2] is set.
- When performing RTMP transmissions, set the Server URL and Stream key acquired from the external application, and then click the [start] button for [SRT/MPEG2-TS/RTMP] in the live screen [Live].
- When performing RTMP transmissions, enable connection with the network in the [Network] screen.

### URL type [Type1, Type2]

Select the method for registering the information for the RTMP/RTMPS transmission server.

Type1	Specify to set the server URL and RTMP/RTMPS stream key as a set in [Server URL].
Type2	Specify to individually set the server URL and RTMP/RTMPS stream key in [Server URL] and [Stream Key].

### URL

Server URL	Set the URL for the RTMP/RTMPS server to be transmitted to.
Stream key	The stream key obtained from the RTMP/RTMPS server is set during streaming only when the service is set to [Type2].

### Streaming format

Make settings for H.264 images for use in RTMP/RTMPS transmission.

The setting is confirmed with the [Set] button.

Refer to the explanation for [H.264] (→ page 127) for information about [Profile type], [Image capture size], [CBR/VBR], [Frame rate], and [Max bit rate(per client)].

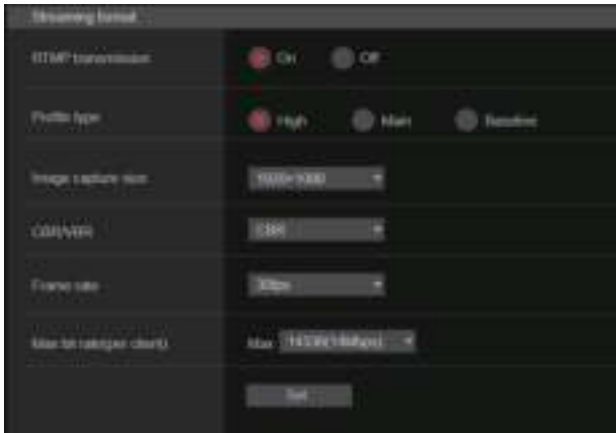

#### <NOTE>

- [Streaming format] settings cannot be changed during RTMP/RTMPS transmissions.
- Set the [Streaming format] to the settings recommended for the transmission destination server. Visit the publisher's website or contact them about the recommended values.
- When [IP(UDP)] of [Tracking Data Output] is set to [On], video transmission via IP may be delayed or the video may suffer frame loss. (→ page 165)  
We recommend [IP(UDP)] of [Tracking Data Output] is set to [Off] during RTMP/RTMPS transmission.

### ● SRT

Make SRT transmission settings.

#### <NOTE>

- When starting SRT transmissions in the [Listener] mode, set the decoder and application to [Client(Caller)] mode and set the following URL:  
srt://[unit's IP address]:[value set in Client(Caller) port]
- When performing SRT transmissions in the [Client(Caller)] mode, set the IP address and port number of the decoder and application to [Destination IP address(IPv4)] and [Destination port], and then click the [start] button for [SRT/MPEG2-TS/RTMP] in the live screen [Live].

### Common setup

The setting is confirmed with the [Set] button.

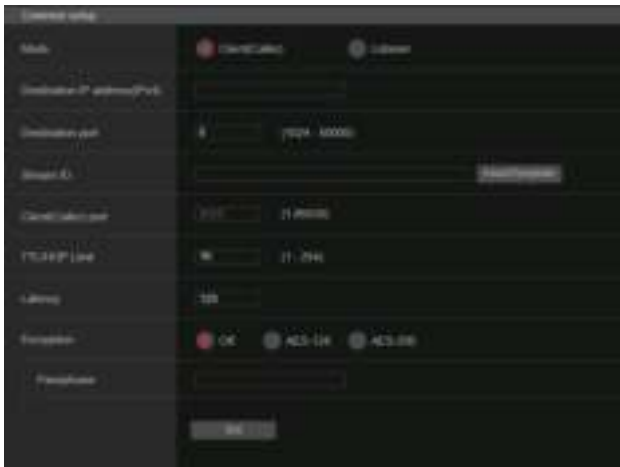

### Mode [Client(Caller), Listener]

Selects the method to connect to the SRT compatible decoder or service.

Client(Caller)	Specify the transmission destination IP address and port number when starting transmission from this unit.
Listener	Specify the listener port when awaiting the external request to start transmission.

**Factory settings:** Listener

#### Destination IP address(IPv4)

When [Client(Caller)] is set in [Mode], enter the IP address. Images and audio will be sent to the specified IP address.

**Factory settings:** 192.168.0.3

#### <NOTE>

- Only IPv4 can be set as the IP address.

#### Destination port [1 to 65535]

When [Client(Caller)] is set in [Mode], enter the port number (used when transmitting images from this unit).

Connection is to the specified port number.

**Factory settings:** 7002

#### Stream ID

When [Client(Caller)] is set in [Mode], enter the Stream ID.

The information entered is notified to the connection destination when SRT transmission is started.

If the [InsertTemplate] button is clicked, the following template is inserted in the input fields.

#!::m=publish,r=PanasonicStream

- The following characters can be displayed.

Numeric characters	0123456789
Alphabetical characters (upper and lower cases)	ABCDEFGHIJKLMNOPQRSTUVWXYZ abcdefghijklmnopqrstuvwxyz
Symbols	!"#%&'()*~^-^ \" @[]{}*+;<>.,?^_

**Factory settings:** #!::m=publish,r=PanasonicStream

#### Client(Caller) port [1 to 65535]

When [Listener] is set in [Mode], enter the port number (used when this unit is waiting for a connection).

The following port numbers are used by the unit so they cannot be used.

20, 21, 23, 25, 42, 53, 67, 68, 69, 80, 110, 123, 161, 162, 443, 546, 547, 554, 995, 5960 to 5985, 7960 to 8060, 10669, 10670, 11900, 59000 to 61000

**Factory settings:** 2020

#### TTL/HOP Limit

The same as [H.264] [Multicast TTL/HOPLimit] (→ page 129).

**Factory settings:** 254

#### Latency

Sets the time between when images and audio are sent and when they are played on the receiving device in a range between 0 and 99999 (ms).

**Factory settings:** 120

#### <NOTE>

- In some cases, the set time is not guaranteed depending on the network band.

## Web screen configurations (continued)

### Encryption [Off, AES-128, AES-256]

Sets whether to encrypt the transmitted IP image. (10 to 24 characters)

Off	Transmits unencrypted IP images.
AES-128	Encrypts IP images in AES-128 before transmitting.
AES-256	Encrypts IP images in AES-256 before transmitting.

### Factory settings: Off

The following characters can be displayed.

Numeric characters	0123456789
Alphabetical characters (upper and lower cases)	ABCDEFGHIJKLMNOPQRSTUVWXYZ abcdefghijklmnopqrstuvwxyz
Symbols	_ -

### Passphrase

Sets the phrase used for decoding the encrypted IP images.

### Streaming format

Makes settings for H.264 or H.265 images for use in SRT transmission.

The setting is confirmed with the [Set] button.

Refer to the explanation for [H.264] (→ page 127) or [H.265] (→ page 129) for information about [Profile type], [Image capture size], [CBR/VBR], [Frame rate] and [Max bit rate(per client)].

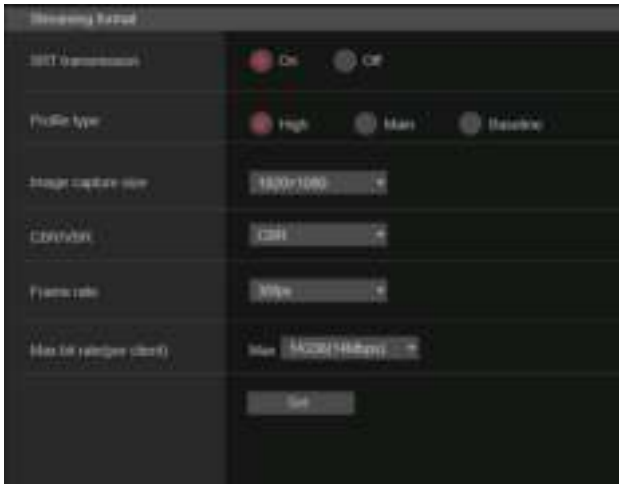

### <NOTE>

- [Streaming format] settings cannot be changed during SRT transmissions.
- When [IP(UDP)] of [Tracking Data Output] is set to [On], video transmission via IP may be delayed or the video may suffer frame loss. (→ page 165)  
We recommend [IP(UDP)] of [Tracking Data Output] is set to [Off] during SRT transmission.
- When the frame frequency is 24/23.98Hz, you cannot set to the SRT(H.264), SRT(H.264 UHD), SRT(H.265), or SRT(H.265 UHD) modes.

### ● MPEG2-TS over UDP

Make settings for MPEG2-TS over UDP transmission.

### <NOTE>

In order to receive the images being transmitted by the camera, enter the following URL in the application or service.

- For Unicast  
udp://@[unicast ipaddress]:[unicast port]
- For Multicast  
udp://@[multicast ipaddress]:[multicast port]

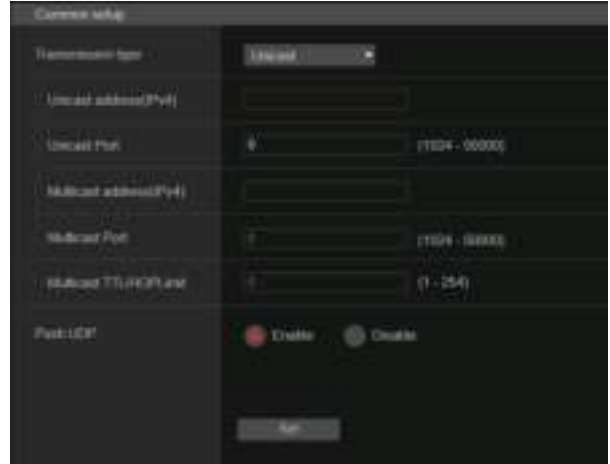

### Transmission type [Unicast, Multicast]

Sets the transmission type for MPEG2-TS over UDP transmission as either [Unicast] or [Multicast].

**Factory settings:** Unicast

### Unicast address(IPv4)

Sets the Unicast address used for MPEG2-TS over UDP transmission.

Specify this IP address on the receiving application or service.

**Factory settings:** 192.168.0.3

### Unicast Port [1024 to 50000]

Sets the Unicast port number used for MPEG2-TS over UDP transmission.

Specify this port number on the receiving application or service.

**Factory settings:** 7002

### Multicast address(IPv4)

Sets the Multicast address used for MPEG2-TS over UDP transmission.

Specify this IP address on the receiving application or service.

**Factory settings:** 239.192.0.20

### Multicast Port [1024 to 50000]

Sets the Multicast port number used for MPEG2-TS over UDP transmission.

Specify this port number on the receiving application or service.

**Factory settings:** 32004

### Multicast TTL/HOPLimit

The same as [H.264] [Multicast TTL/HOPLimit] (→ page 129).

### Push UDP [Enable, Disable]

When [Push UDP] has been set to [Enable], MPEG2-TS over UDP transmission starts automatically when the camera is started.

**Factory settings:** Enable

**Streaming format**

Make settings for H.264 images used for MPEG2-TS over UDP transmission.

The setting is confirmed with the [Set] button.

Refer to the explanation of [H.264] (→ page 127) for information about [Profile type], [Image capture size], [CBR/VBR], [Frame rate], and [Max bit rate(per client)].

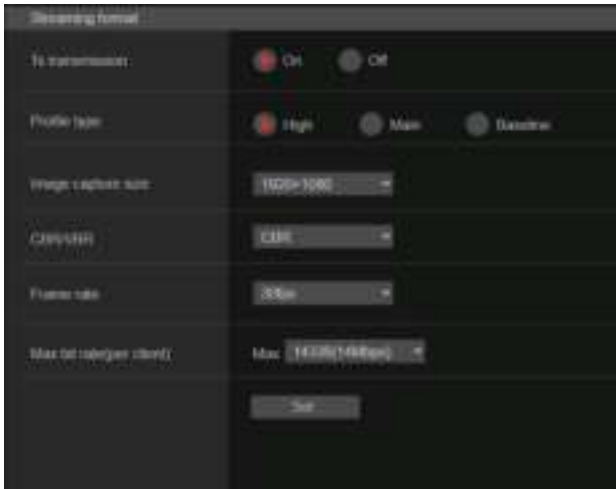

**<NOTE>**

- [Streaming format] settings cannot be changed during MPEG2-TS over UDP transmissions.
- When [IP(UDP)] of [Tracking Data Output] is set to [On], video transmission via IP may be delayed or the video may suffer frame loss. (→ page 165)  
We recommend [IP(UDP)] of [Tracking Data Output] is set to [Off] during MPEG2-TS over UDP transmission.

**● NDI|HX V2/NDI|HX V2(UHD)**

Make NDI|HX V2 transmission settings.  
The setting is confirmed with the [Set] button.

**NDI|HX V2**



**<NOTE>**

- This unit restarts when [Streaming mode] is changed to [NDI|HX V2], or when changed from [NDI|HX V2] to another mode.

**Source name**

Sets the device name displayed when this unit is detected by software applications and hardware compatible with NDI|HX.

**Factory settings:** NDI\_Device-[serial number of this unit]

Maximum number of characters	1 to 32 characters
Characters that can be entered	Alphanumeric characters, symbols: - _

**Protocol [TCP, UDP, RUDP]**

Sets the format of unicast transmission to be used.

**Factory settings:** RUDP

**Multicast Transmit [On, Off]**

Sets whether to perform multicast transmissions of images for software applications and hardware that are compatible with NDI.

**Factory settings:** Off

**Address(IPv4) [IPv4 : 224.0.0.0 to 239.255.255.255]**

Enter the multicast IP address.

Images and audio are transmitted to the specified multicast address.

**Factory settings:** 239.192.0.30

**<NOTE>**

- Check the multicast IP addresses available for use before entering.

**Subnet(IPv4)**

Enter the subnet mask.

**Factory settings:** 225.255.255.255

**<NOTE>**

- [Address (IPv4)] and [Subnet (IPv4)] clarify the multicast address ranges randomly set during multicast transmissions.
- When [Address (IPv4)] is set to [239.255.0.0] and [Subnet (IPv4)] is set to [255.255.0.0], the selection is made randomly in the range between [239.255.0.0] and [239.255.255.255].
- To use the IP address set in [Address (IPv4)], set [Subnet (IPv4)] to [255.255.255.255].

**TTL/HOP Limit**

The same as the [H.264] [Multicast TTL/HOPLimit] (→ page 129).

**Group [Enable, Disable]**

Sets whether to use the grouping function when performing NDI transmission.

**Factory settings:** Disable

**Name**

Sets the group name for use when the grouping function is used.

Maximum number of characters	1 to 32 characters
Characters that can be entered	Alphanumeric characters

**Use discovery server**

Sets whether to use the discovery server when performing NDI transmission.

**Server address(IPv4)**

Sets the IPv4 address of the server when using the discovery server.

**Streaming format**

Make settings for H.264 images used for NDI|HX V2 transmission. Confirm the settings with the [Set] button.

Refer to the explanation of [H.264] (→ page 127) for information about [Image capture size], [Frame rate], [Max bit rate(per client)] and [CBR/VBR].

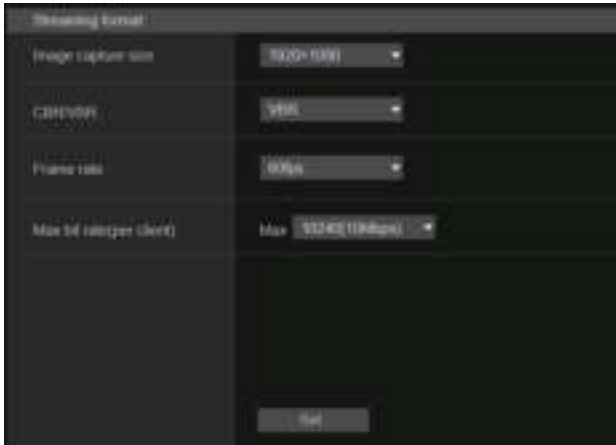

**● High bandwidth NDI**

Make NDI transmission settings.

The setting is confirmed with the [Set] button.

**High bandwidth NDI**



**Format**

Displays the resolution of NDI images.

**<NOTE>**

- For the resolution set to Format, confirm the output conditions for each video format (→ page 21).

**Source name**

Set the device name displayed when this unit is detected by software applications and hardware compatible with NDI.

**Factory settings:** NDI Device [serial number of this unit]

**Protocol [TCP, UDP, RUDP]**

Sets the format of unicast transmission to be used.

**Factory settings:** RUDP

**Multicast Transmit [On, Off]**

Sets whether to perform multicast transmission of images for the software applications and hardware compatible with NDI.

**Factory settings:** Off

**Address(IPv4)**

**[IPv4 : 224.0.0.0 to 239.255.255.255]**

Enter the multicast IP address.

Images and audio will be sent to the specified IP address.

**Factory settings:** 239.192.0.30

**<NOTE>**

- Verify usable multicast IP addresses before entering this setting.

### Subnet(IPv4)

Enter the subnet mask.

**Factory settings:** 255.255.255.255

#### <NOTE>

- [Address(IPv4)] and [Subnet(IPv4)] clarify the multicast address ranges randomly selected during multicast transmissions.
- When [Address(IPv4)] is set to [239.255.0.0] and [Subnet(IPv4)] is set to [255.255.0.0], the selection is made randomly in the range between [239.255.0.0] and [239.255.255.255].
- To use the IP address set in [Address(IPv4)], set [Subnet(IPv4)] to [255.255.255.255].

### TTL/HOP Limit

The same as [H.264] [Multicast TTL/HOPLimit] (→ page 129).

### Group [Enable, Disable]

Sets whether to use the grouping function when performing NDI transmission.

**Factory settings:** Disable

### Name

Sets the group name for use when grouping function is used.

### Use discovery server

Sets whether to use the discovery server when performing NDI transmission.

### Server address(IPv4)

Sets the IPv4 address of the server when using the discovery server.

## MoIP settings screen [Media over IP]

Make settings related to MoIP (SMPTE ST2110/NMOS/PTP).

#### <NOTE>

- To use this function with AW-UE160, the SMPTE ST2110 software key (AW-SFU60) needs to be enabled.

### Setting status



### ST2110

Display the Off/On status of the SMPTE ST2110 function and the port number used for SMPTE ST2110 transmissions.

### Main video TX

Display the transmission settings for [Main video TX].

### Crop video TX

Display the transmission settings for [Crop video TX].

### Monitor video TX

Display the transmission settings for [Monitor video TX].

### Input1 audio TX

Display the transmission settings for [Input1 audio TX].

### Input2 audio TX

Display the transmission settings for [Input2 audio TX].

### Return video RX

Display the transmission settings for [Return video RX].

### PTP

Display the [PTP] settings.

### NMOS

Display the [NMOS] settings.

### NMOS Master Enable

Display the [NMOS Master Enable] settings.

This setting can be switched from an NMOS controller that is on the same network as the camera. It is a setting to enable/disable SMPTE ST2110 transmitting and receiving.

#### <NOTE>

- The camera starts with this setting [On] when it is started. The setting value cannot be saved.



## Web screen configurations (continued)

### ● ST2110

SMPTE ST2110 can be transmitted and received from SFP+ with this unit.

The setting is confirmed with the [Set] button.

#### <NOTE>

- This item cannot be set if the SMPTE ST2110 software key (AW-SFU60) is disabled.
- This cannot be set when the [Basic Config] – [SFP+ Mode] is [12G Output].

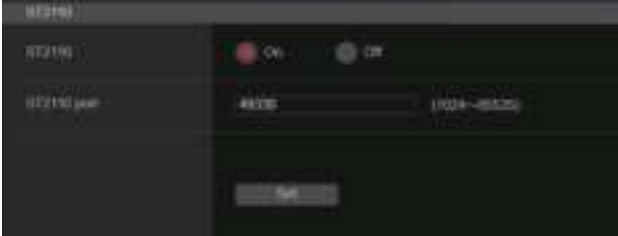

### ST2110 [On, Off]

Set On/Off for SMPTE ST2110 transmitting and receiving.

**Factory settings:** Off

### ST2110 port [1024 to 65535]

Enter the port number for SMPTE ST2110 (used when transmitting SMPTE ST2110 from this unit).

10670 cannot be set as a port number.

**Factory settings:** 49330

### ● ST2110 TX

Make SMPTE ST2110 transmission settings.

The setting is confirmed with the [Set] button.

#### <NOTE>

- This menu is not displayed when [ST2110] is [Off].



### Main video

#### <NOTE>

- Camera images without overlays such as OSD menus and CROP frames are output from Main video.
- When [ST2110] is [Off], Main video is not output.

#### Format

Set the output format for [Main video].

Frequency	System Format	Format(ST2110)
59.94Hz	1080/59.94p	1080/59.94p 1080/59.94i
50Hz	1080/50p	1080/50p 1080/50i

For formats other than the above, there is display only and the settings cannot be changed.

#### Destination Address

Enter the IP address of the transmission destination for [Main video].

IP addresses can be set in the following ranges:

First octet	0 to 239
Second octet	0 to 255
Third octet	0 to 255
Fourth octet	0 to 255

You cannot set 0.0.0.0, 224.0.0.0 to 224.0.1.255, or a 127 IP address for the first octet.

**Factory settings:** 239.1.0.1

#### Destination Port [1024 to 65535]

Enter the [Main video] transmission destination port number.

10670 cannot be set as a port number.

**Factory settings:** 49311



### Crop video

#### <NOTE>

- CROP images without overlays such as OSD menus are output from Crop video.
- When [ST2110] is [Off], and [UHD Crop] – [Crop Mode] is set to [Off], Crop video is not output.

#### Format

Display the output format for [Crop video].

#### Destination Address

Enter the [Crop video] transmission destination IP address.  
The setting range is the same as [Main video].

**Factory settings:** 239.1.0.2

#### Destination Port [1024 to 65535]

Enter the [Crop video] transmission destination port number.  
The setting range is the same as [Main video].

**Factory settings:** 49312

### Monitor video

#### <NOTE>

- The same images as 3G SDI OUT2/PM are output from Monitor video.
- When [ST2110] is [Off] and [Output] – [3G SDI Out2/PM] – [OUTPUT SELECT] is set to [RETURN], Monitor video is not output.

#### Format

Display the output format for [Monitor video].

#### Destination Address

Enter the [Monitor video] transmission destination IP address.  
The setting range is the same as [Main video].

**Factory settings:** 239.1.0.3

#### Destination Port [1024 to 65535]

Enter the [Monitor video] transmission destination port number.  
The setting range is the same as [Main video].

**Factory settings:** 49313

### Input1 audio

#### <NOTE>

- When [Audio] – [CH Select] is [Input2], the Input1 Audio of ST2110 is not output.

#### Destination Address

Enter the [Input1 audio] transmission destination IP address.  
The setting range is the same as [Main video].

**Factory settings:** 239.2.0.1

#### Destination Port [1024 to 65535]

Enter the [Input1 audio] transmission destination port number.  
The setting range is the same as [Main video].

**Factory settings:** 49321

### Input2 audio

#### <NOTE>

- When [Audio] - [CH Select] is [Input1], the Input2 Audio of ST2110 is not output.

#### Destination Address

Enter the [Input2 audio] transmission destination IP address.  
The setting range is the same as [Main video].

**Factory settings:** 239.2.0.2

#### Destination Port [1024 to 65535]

Enter the [Input2 audio] transmission destination port number.  
The setting range is the same as [Main video].

**Factory settings:** 49322

## Web screen configurations (continued)

### ● ST2110 RX

Make SMPTE ST2110 reception settings.

The setting is confirmed with the [Set] button.

#### <NOTE>

- This menu is not displayed when [ST2110] is [Off].

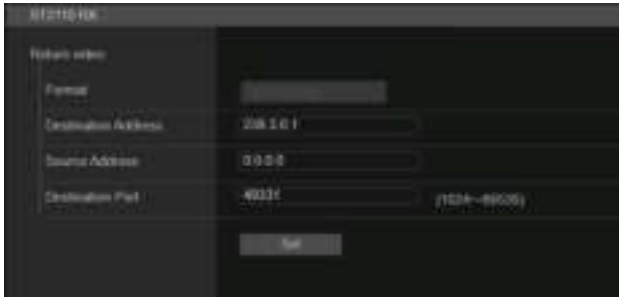

### Return video

#### <NOTE>

- Return video cannot be input when [ST2110] is [Off] and [Basic Config] – [Format] is other than [1080/59.94p] or [1080/50p].

#### Format

Display the input format for [Return video].

#### Destination Address

Enter the multicast address of the stream to be received as [Main video].

The setting range of the IP addresses can be set.

First octet	224 to 239
Second octet	0 to 255
Third octet	0 to 255
Fourth octet	0 to 255

0.0.0.0 and 224.0.0.0 to 224.0.1.255 cannot be set as the IP address.

**Factory settings:** 239.3.0.1

#### Source Address

Enter the IP address of the device that is the transmission source of the stream to be received as [Main video].

The setting range of the IP addresses can be set.

First octet	0 to 223
Second octet	0 to 255
Third octet	0 to 255
Fourth octet	0 to 255

An IP address with a first octet that is 127 cannot be set.

**Factory settings:** 0.0.0.0

#### <NOTE>

- Filtering by the transmission source address is not performed if 0.0.0.0 is set.
- If the network switch you are using does not support IGMPv3, filtering by the transmission source address is not possible.

#### Destination Port [1024 to 65535]

Enter the port number of the stream to be received as [Main video].

10670 cannot be set as a port number.

**Factory settings:** 49331

### ● PTP

Make PTP settings.

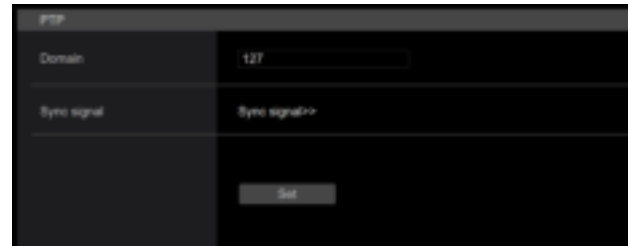

#### Domain

Enter the PTP domain number.

**Factory settings:** 127

#### <NOTE>

- The domain number needs to be set in conjunction with the grand master. Consult the network administrator regarding settings for the grand master.
- This can only be set when [Sync signal] is [PTP].

#### Sync signal

The screen for setting the synchronization signal for video/audio is displayed when you click [Sync signal>>]. (→ page 115)

## Web screen configurations (continued)

### ● NMOS

Make NMOS settings.

#### <NOTE>

- This menu is not displayed when [ST2110] is [Off].

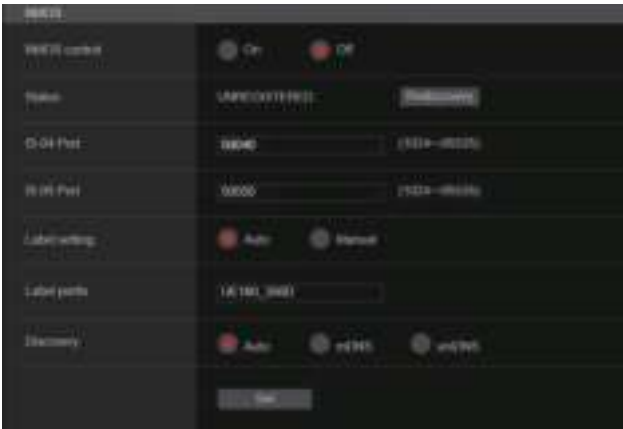

### NMOS control [On, Off]

Set Off/On for the NMOS function.

**Factory settings:** Off

#### <NOTE>

- To set [NMOS] to [On], the SMPTE ST2110 software key (AW-SFU60) needs to be enabled.

### Status

Displays the connection status of the NMOS RDS server.

UNREGISTERED	Not connected
REGISTERING	Currently discovering RDS server
REGISTERED	Registered to RDS server
P2P MODE	Connected via P2P with NMOS controller

### IS-04 Port [1024 to 65535]

Enter the port number for NMOS IS-04.

**Factory settings:** 50040

### IS-05 Port [1024 to 65535]

Enter the port number for NMOS IS-05.

**Factory settings:** 50050

### Label setting

Select the automatic/manual label name used with NMOS.

Manual	The user enters the label name manually.
Auto	The label name is a fixed value.

**Factory settings:** Auto

#### <NOTE>

- The label name when set to Auto is "UE160\_\*\*\*\*" (asterisks are the last four digits of the MAC address).

### Label prefix

Enter the label name used with NMOS.

This cannot be changed if the Label setting is Auto.

**Factory settings:** UE160\_\*\*\*\* (asterisks are the last four digits of the MAC address)

### Discovery

Set the RDS server discovery method.

Auto	Discover automatically in the order of uniDNS/mDNS.
mDNS	Discover with mDNS.
uniDNS	Discover with unicast DNS.

**Factory settings:** Auto

#### <NOTE>

- If an RDS server cannot be discovered in any of the modes, the mode automatically switches to P2P.

■ **Audio setting screen [Audio]**

Configure audio settings.

<NOTE>

- Images and audio are not synchronized. Therefore, images and audio may be slightly out of sync.
- The audio may skip depending on the network environment.

● **Setting status**

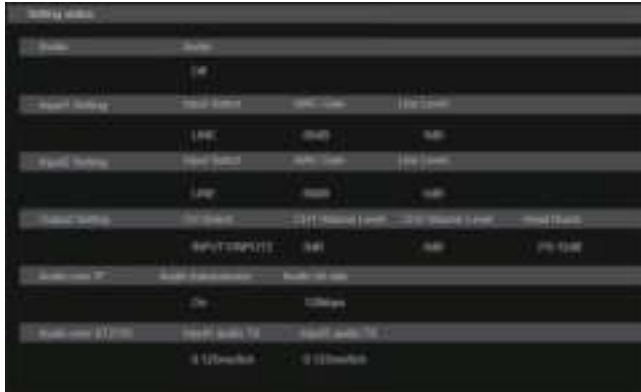

**Audio**

The setting status of audio input is displayed.

**Input1 Setting**

Display the setting status of audio input 1.

**Input2 Setting**

Display the setting status of audio input 2.

**Output Setting**

Display the setting status of audio output.

**Audio over IP**

Audio transmission	The setting status of audio data IP transmission is displayed.
Audio bit rate	The bit rate setting status for audio data via IP transmission is displayed.

**Audio over ST2110**

Display the setting status of audio data with SMPTE ST2110 transmission.

● **Audio**

The setting is confirmed with the [Set] button.



**Audio [Off, On]**

Turn audio input Off/On.

**Factory settings:** Off

**Input Setting 1**

**Input Select [LINE, MIC, MIC+48V]**

Set the input switching for Audio Input1.

LINE	Sets to line input.
MIC	Sets to microphone input.
MIC+48V	Sets to phantom power supply +48V microphone input.

This is only enabled when [Audio] is set to [On].

**Factory settings:** LINE

**Mic Gain [60dB, 40dB]**

Set the microphone amplifier GAIN for the Audio Input1 microphone input.

This is enabled only when [Audio] – [Input1 Setting] – [Input Select] is [MIC] or [MIC+48V].

**Factory settings:** 60dB

**Line Level [+4dB, 0dB]**

Set the input level for the Audio Input1 line input.

This is enabled only when [Audio] – [Input1 Setting] – [Input Select] is [LINE].

**Factory settings:** 0dB

### Input Setting 2

#### Input Select [LINE, MIC, MIC+48V]

Set the input switching for Audio Input2.

LINE	Sets to line input.
MIC	Sets to microphone input.
MIC+48V	Sets to phantom power supply +48V microphone input.

This is only enabled when [Audio] is set to [On].

**Factory settings:** LINE

#### Mic Gain [60dB, 40dB]

Set the microphone amplifier GAIN for the Audio Input2 microphone input.

This is enabled only when [Audio] – [Input2 Setting] – [Input Select] is [MIC] or [MIC+48V].

**Factory settings:** 60dB

#### Line Level [+4dB, 0dB]

Set the input level for the Audio Input2 line input.

This is enabled only when [Audio] – [Input2 Setting] – [Input Select] is [LINE].

**Factory settings:** 0dB

### Output Setting

Display the setting status of audio output.

#### CH Select [Input1/Input2, Input1, Input2]

Select the audio output destination.

Input1/Input2	CH1-Input1/CH2-Input2
Input1	CH1-Input1/CH2-Input1
Input2	CH1-Input2/CH2-Input2

**Factory settings:** Input1/Input2

#### <NOTE>

- When [CH SELECT] is [Input1], the Input2 Audio of ST2110 is not output.
- When [CH SELECT] is [Input2], the Input1 Audio of ST2110 is not output.

#### CH1 Volume Level

**[–40dB to 0dB to +20dB (1dB step)]**

Set the volume for CH1 audio output.

**Factory settings:** 0dB

#### CH2 Volume Level

**[–40dB to 0dB to +20dB (1dB step)]**

Set the volume for CH2 audio output.

**Factory settings:** 0dB

#### Head Room [FS-12dB, FS-18dB, FS-20dB]

Set the audio head room (base level).

FS-12dB	–12dBFS
FS-18dB	–18dBFS
FS-20dB	–20dBFS

**Factory settings:** FS-12dB

### ● Audio over IP

The setting is confirmed with the [Set] button.

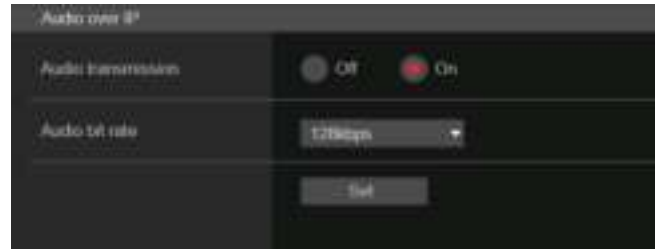

### Audio transmission [Off, On]

Set the communication mode used to transmit audio data to a personal computer, etc.

Off	Do not transmit audio data. All settings and controls related to audio will be disabled.
On	Transmit audio data. This allows audio as well as images to be viewed on the personal computer.

**Factory settings:** On

### Audio bit rate [64kbps, 96kbps, 128kbps, 256kbps]

Set the bit rate for transmitting audio.

**Factory settings:** 128kbps

### ● Audio over ST2110

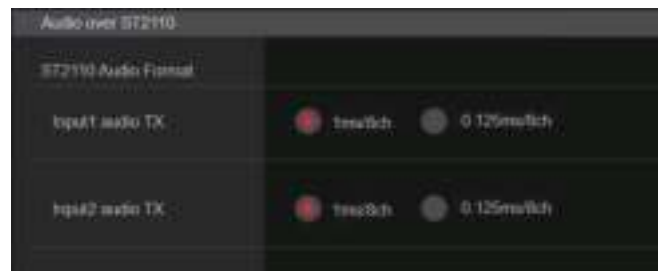

### ST2110 Audio Format

#### Input1 audio TX [1ms/8ch, 0.125ms/8ch]

Set the format for AUDIO (Input1 audio TX) of SMPTE ST2110.

**Factory settings:** 1ms/8ch

#### Input2 audio TX [1ms/8ch, 0.125ms/8ch]

Set the format for AUDIO (Input2 audio TX) of SMPTE ST2110.

**Factory settings:** 1ms/8ch

#### <NOTE>

- This item cannot be set if the SMPTE ST2110 software key (AW-SFU60) is disabled.
- This cannot be set when the [Basic Config] – [SFP+ Mode] is [12G Output].

**■ Paint settings screen [Paint]**

Adjust the image quality.

The settings in this screen (with the exception of [Scene] and [Matrix]) are applied immediately. After selecting the settings for [Scene] and [Matrix], you need to press the [Set] button to execute.

**SCENE [Scene1 to Scene8]**

**USER [User1 to User3]**

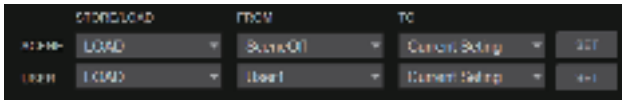

Switch the shooting mode depending on the shooting environment. Select a shooting mode based on the shooting conditions or preference.

Select a shooting mode from the pull-down menu, and click the [SET] button to switch to the selected mode.

Scene1 to Scene8, User1 to User3	Modes that allow you to adjust detailed settings manually for various shooting conditions and preferences.
----------------------------------	--

**Camera control/Setup Menu button**



You can display the camera control screen by clicking the [Camera control] button.

You can control the camera while adjusting the image quality.

**● BRIGHTNESS**



## Web screen configurations (continued)

### ● GAIN SETTING

#### GAIN [-6dB to 12dB]

Make adjustments to the gain of images.

**Factory settings:** 0

#### AGC [OFF, ON]

Set the behavior of auto gain control.

**Factory settings:** OFF

#### AGC MAX GAIN [6dB, 12dB]

Set the maximum amount of gain increase when [AGC] is working.

**Factory settings:** 12dB

#### FRAME MIX SW [OFF, ON]

Set the control for frame addition (gain increase using sensor storage).

**Factory settings:** OFF

#### FRAME MIX [6dB, 12dB, 18dB, 24dB]

Set the frame addition (gain-up using sensor storage) amount.

When frame addition is performed, it will appear as if the images are missing some frames.

**Factory settings:** 6dB

#### DAY/NIGHT [DAY, NIGHT]

Switch between standard shooting and night-vision shooting (shooting with infrared light).

DAY	Standard shooting (day mode)
NIGHT	Night-vision shooting (night mode)

**Factory settings:** DAY

#### <NOTE>

- In night mode, video output will be in black and white. In addition, the iris will be forcibly opened.
- White balance adjustment is not possible in night mode.
- ND filter switching is not possible in night mode.

### ● IRIS

#### AUTO IRIS [OFF, ON]

Select whether to turn auto iris adjustment OFF/ON.

OFF	Do not adjust iris automatically.
ON	Adjust iris automatically.

**Factory settings:** OFF

#### WINDOW SELECT [1 to 4]

Set the photometry range when [AUTO IRIS] is on.

**Factory settings:** 1

#### PICTURE LEVEL [-50 to +50]

Set the target picture level for automatic exposure compensation.

**Factory settings:** 0

#### PEAK RATIO [0 to 100]

Set the peak value and average value ratio of the photometry when [AUTO IRIS] is on.

The larger the number in the setting value, the more there is a reaction to the peak within the iris detection window.

The smaller the number in the setting value, the more there is a reaction to the average value within the iris detection window.

**Factory settings:** 0

#### AUTO IRIS CLOSE LIMIT [NORMAL, F8, F7, F5.6]

Set the control speed of the auto iris function.

NORMAL	Moves up to the normal position (the vicinity of F9).
F8	The limit is in the vicinity of F8.
F7	The limit is in the vicinity of F7.
F5.6	The limit is in the vicinity of F5.6.

**Factory settings:** NORMAL

#### IRIS SPEED [1 to 3]

Set the control speed of the iris function.

1	Control the iris at a slow speed.
2	Control the iris at a normal speed.
3	Control the iris at a fast speed.

**Factory settings:** 0

### ● SHUTTER SPEED

#### SHUTTER SW [Off, On]

Set On/Off for the shutter function.

#### SHUTTER MODE [STEP, SYNCHRO]

Select the shutter mode.

STEP	The step shutter is set (the steps can be changed).
SYNCHRO	The synchro shutter is set (the setting can be changed continuously).

**IRIS SPEED**

The shutter speeds that can be set are listed below.

	When [STEP] is selected as the [SHUTTER MODE]
60p/59.94p/ 59.94i mode	1/100, 1/120, 1/125, 1/250, 1/500, 1/1000, 1/1500, 1/2000
29.97p mode	1/48, 1/50, 1/60, 1/96, 1/100, 1/120, 1/125, 1/250, 1/500, 1/1000, 1/1500, 1/2000
23.98p mode	1/48, 1/50, 1/60, 1/96, 1/100, 1/120, 1/125, 1/250, 1/500, 1/1000, 1/1500, 1/2000
50p/50i mode	1/60, 1/100, 1/125, 1/250, 1/500, 1/1000, 1/1500, 1/2000
25p mode	1/48, 1/50, 1/60, 1/96, 1/100, 1/125, 1/250, 1/500, 1/1000, 1/1500, 1/2000
119.88p mode	1/125, 1/250, 1/500, 1/1000, 1/1500, 1/2000
100p mode	1/125, 1/250, 1/500, 1/1000, 1/1500, 1/2000

**Factory settings:**

- [59.94Hz] 1/100
- [50Hz] 1/120

**SYNCHRO SCAN**

This is used to adjust the shutter speed in the mode which was selected as the [SHUTTER MODE] setting. When a higher shutter speed is selected, fast-moving subjects do not become blurred easily but the images will be darker.

The shutter speeds that can be set are listed below.

	When [SYNCHRO] is selected as the [SHUTTER MODE]
60p/59.94p/59.94i mode	60.0 Hz to 7200 Hz
29.97p mode	30.0 Hz to 7200 Hz
23.98p mode	24.0 Hz to 7200 Hz
50p/50i mode	50.0 Hz to 7200 Hz
25p mode	25.0 Hz to 7200 Hz
119.88p mode	120.1 Hz to 7200 Hz
100p mode	100.1 Hz to 7200 Hz

**Factory settings:**

- [59.94Hz] 60.0Hz
- [50Hz] 50.0Hz

**AUTO SHUTTER [Off, On]**

Select whether to turn auto shutter mode Off/On.

Off	Set auto shutter mode to Off.
On	Set auto shutter mode to On.

**Factory settings:** Off

**AUTO SHUTTER LIMIT [1/100, 1/120, 1/250]**

Set the maximum shutter value of the auto shutter mode. This is enabled only when [AUTO SHUTTER] is [On].

**Factory settings:** 1/100

**PICTURE**







## Web screen configurations (continued)

### ● PEDESTAL

#### <NOTE>

- For all of the PEDESTAL items, setting is not possible when [V-LOG] is [On] and [V-LOG PAINT SW] is [Off].

#### MASTER PEDESTAL [-200 to +200]

This item is used to adjust the black level (adjust the pedestal). These parts become darker when a negative setting is selected and, conversely, lighter when a positive setting is selected.

**Factory settings:** 0

#### R PEDESTAL [-800 to +800]

This enables the R pedestal to be adjusted.

**Factory settings:** 0

#### G PEDESTAL [-800 to +800]

This enables the G pedestal to be adjusted.

**Factory settings:** 0

#### B PEDESTAL [-800 to +800]

This enables the B pedestal to be adjusted.

**Factory settings:** 0

#### PEDESTAL OFFSET [Off, On]

Set the pedestal level of the Rch, Gch, and Bch when the auto black balance has been adjusted.

Off	Set the pedestal level to [0] for [R PEDESTAL], [G PEDESTAL], and [B PEDESTAL].
On	Maintain the values set for each of [R PEDESTAL], [G PEDESTAL], and [B PEDESTAL].

**Factory settings:** Off

### ● CHROMA

#### <NOTE>

- For all of the CHROMA items, setting is not possible when [V-LOG] is [On] and [V-LOG PAINT SW] is [Off].

#### CHROMA LEVEL SWITCH [Off, On]

Select Off/On for the color intensity setting for images.

Off	Set the color intensity setting for images to Off.
On	Set the color intensity setting for images to On.

#### CHROMA LEVEL [-100% to 40%]

Set here the color intensity (chroma level) of the images.

**Factory settings:** 0%

### ● COLOR TEMP SETTING / V-LOG COLOR TEMP SETTING

#### <NOTE>

- For all of the COLOR TEMP SETTING / V-LOG COLOR TEMP SETTING items, setting is not possible when [V-LOG] is [On] and [V-LOG PAINT SW] is [Off].

#### COLOR TEMP ACH/BCH

Set the color temperature when the [WHITE BALANCE MODE] is [AWB A] or [AWB B].

Varying the output balance of Ach and Bch enables the varying of the color temperature.

#### COLOR TEMP ACH [2000K to 15000K]

This displays the color temperature when [WHITE BALANCE MODE] is [AWB A].

**Factory settings:** 3200K

#### R GAIN ACH [-400 to +400]

This enables adjustments to R Gain when [WHITE BALANCE MODE] is [AWB A].

**Factory settings:** 0

#### B GAIN ACH [-400 to +400]

This enables adjustments to B Gain when [WHITE BALANCE MODE] is [AWB A].

**Factory settings:** 0

#### G AXIS ACH [-400 to +400]

You can adjust the gain in the G-Mg direction when the [WHITE BALANCE MODE] is [AWB A].

**Factory settings:** 0

#### COLOR TEMP BCH [2000K to 15000K]

This displays the color temperature when [WHITE BALANCE MODE] is [AWB B].

**Factory settings:** 3200K

#### R GAIN BCH [-400 to +400]

This enables adjustments to R Gain when [WHITE BALANCE MODE] is [AWB B].

**Factory settings:** 0

#### B GAIN BCH [-400 to +400]

This enables adjustments to B Gain when [WHITE BALANCE MODE] is [AWB B].

**Factory settings:** 0

#### G AXIS BCH [-400 to +400]

You can adjust the gain in the G-Mg direction when the [WHITE BALANCE MODE] is [AWB B].

**Factory settings:** 0

### ● RGB GAIN CONTROL SETTING

#### <NOTE>

- For all of the RGB GAIN CONTROL SETTING items, setting is not possible when [V-LOG] is [On] and [V-LOG PAINT SW] is [Off].

#### G GAIN REL CONTROL SWITCH [Off, On]

Set On/Off for the relative value control of the G gain.

**Factory settings:** Off

#### RGB GAIN PRESET

Set the gain when the [WHITE BALANCE MODE] is [3200K], [5600K], or [VAR].

##### R GAIN [-1000 to +1000]

This enables the R gain to be adjusted.

**Factory settings:** 0

##### G GAIN [-1000 to +1000]

This enables the G gain to be adjusted.

**Factory settings:** 0

##### B GAIN [-1000 to +1000]

This enables the B gain to be adjusted.

**Factory settings:** 0

#### RGB GAIN ACH/BCH

Set the gain when the [WHITE BALANCE MODE] is [AWB A] or [AWB B].

#### ACH

##### R GAIN ACH [-1000 to +1000]

You can adjust the R gain when the [WHITE BALANCE MODE] is [AWB A].

**Factory settings:** 0

##### B GAIN ACH [-1000 to +1000]

You can adjust the B gain when the [WHITE BALANCE MODE] is [AWB A].

**Factory settings:** 0

##### G GAIN ACH [-1000 to +1000]

You can adjust the G gain when the [WHITE BALANCE MODE] is [AWB A].

**Factory settings:** 0

##### GAIN OFFSET ACH [Off, On]

When auto white balance is performed by setting [WHITE BALANCE MODE] to [AWB A], set the values for R gain and B gain.

Off	Makes the [R GAIN ACH] and [B GAIN ACH] values [0].
On	Leaves the values set in [R GAIN ACH] and [B GAIN ACH] as they are.

**Factory settings:** Off

#### BCH

##### R GAIN BCH [-1000 to +1000]

You can adjust the R gain when the [WHITE BALANCE MODE] is [AWB B].

**Factory settings:** 0

##### B GAIN BCH [-1000 to +1000]

You can adjust the B gain when the [WHITE BALANCE MODE] is [AWB B].

**Factory settings:** 0

##### G GAIN BCH [-1000 to +1000]

You can adjust the G gain when the [WHITE BALANCE MODE] is [AWB B].

**Factory settings:** 0

##### GAIN OFFSET BCH [Off, On]

When auto white balance is performed by setting [WHITE BALANCE MODE] to [AWB B], set the values for R gain and B gain.

Off	Makes the [R GAIN BCH] and [B GAIN BCH] values [0].
On	Leaves the values set in [R GAIN BCH] and [B GAIN BCH] as they are.

**Factory settings:** Off

### ● FLARE

#### <NOTE>

- For all of the FLARE items, setting is not possible when [V-LOG] is [On] and [V-LOG PAINT SW] is [Off].

#### FLARE [Off, On]

Set Off/On for flare compensation.

**Factory settings:** Off

##### MASTER FLARE [-200 to 0 to +200]

Adjust the master flare.

**Factory settings:** 0

##### R FLARE [-200 to 0 to +200]

Adjust the Rch flare.

**Factory settings:** 0

##### G FLARE [-200 to 0 to +200]

Adjust the Gch flare.

**Factory settings:** 0

##### B FLARE [-200 to 0 to +200]

Adjust the Bch flare.

**Factory settings:** 0

#### DNR / V-LOG DNR

#### <NOTE>

- For all of the DNR / V-LOG DNR items, setting is not possible when [V-LOG] is [On] and [V-LOG PAINT SW] is [Off].

#### DNR SW [OFF, ON]

Select OFF/ON for the digital noise reduction effect which can achieve output of bright, clear images without noise, even at night and low-light conditions.

**Factory settings:** OFF

##### DNR LEVEL [1 to 5]

Set the digital noise reduction level.

**Factory settings:** 3

### ● HDR PAINT

#### HLG MODE [FIX, VAR]

Select image quality setting mode for HDR.

**Factory settings:** FIX

<NOTE>

- This is disabled when [V-LOG] is [On].

#### SDR CONVERT MODE [FIX, VAR]

Select the mode for converting to SDR.

FIX	Fixed mode
VAR	Variable mode

**Factory settings:** FIX

### GAMMA/BLACK GAMMA

#### BLACK GAMMA SW [Off, On]

Select On/Off for the gamma curve for dark areas.

**Factory settings:** Off

#### MASTER BLACK GAMMA [–32 to +32]

Adjust the master black gamma correction level.

**Factory settings:** 0

#### R BLACK GAMMA [–32 to +32]

Make adjustments to the black gamma correction level for the Rch.

**Factory settings:** 0

#### B BLACK GAMMA [–32 to +32]

Make adjustments to the black gamma correction level for the Bch.

**Factory settings:** 0

### KNEE

<NOTE>

- For all of the KNEE items, setting is not possible when [V-LOG] is [On] and [V-LOG PAINT SW] is [Off].
- For all of the KNEE items, setting is not possible when [HDR] is [On].
- When [DRS] is enabled, the knee setting is disabled.

#### KNEE SW [Off, On]

Set On/Off for the operating mode for gradation compression (knee).

**Factory settings:** On

#### KNEE POINT [–25.00% to 25.00% (0.25% step)]

Set the compression level (knee point) position for high-brightness video signals.

This is only enabled when [KNEE SW] is set to [On].

**Factory settings:** 0

#### KNEE SLOPE [–25.00% to 25.00% (0.25% step)]

Set the incline of knee.

This is only enabled when [KNEE SW] is set to [On].

**Factory settings:** 0

### SDR CONVERT

The setting is disabled when [FIX] is selected in [SDR CONVERT MODE] and it cannot be set.

#### GAIN [0dB, –5dB, –6dB, –7dB, –8dB, –9dB, –10dB, –11dB, –12dB]

Set the gain of SDR images.

**Factory settings:** –6

#### POINT [000 to 100]

Set the image level to start SDR image compression.

**Factory settings:** 0

#### SLOPE [000 to 127]

Set the incline for compression of SDR images.

**Factory settings:** 0

#### BLACK OFFSET [–100 to +100]

Adjust the black level offset of SDR images.

**Factory settings:** 0

**MATRIX**



**LINEAR MATRIX**

Make adjustments to the linear matrix.

**<NOTE>**

- For all of the LINEAR MATRIX items, setting is not possible when [V-LOG] is [On] and [V-LOG PAINT SW] is [Off].

**COLOR R-G**

NEGATIVE [-31 to +31]	Set N direction of R-G.
POSITIVE [-31 to +31]	Set P direction of R-G.

**COLOR R-B**

NEGATIVE [-31 to +31]	Set N direction of R-B.
POSITIVE [-31 to +31]	Set P direction of R-B.

**COLOR G-R**

NEGATIVE [-31 to +31]	Set N direction of G-R.
POSITIVE [-31 to +31]	Set P direction of G-R.

**COLOR G-B**

NEGATIVE [-31 to +31]	Set N direction of G-B.
POSITIVE [-31 to +31]	Set P direction of G-B.

**COLOR B-R**

NEGATIVE [-31 to +31]	Set N direction of B-R.
POSITIVE [-31 to +31]	Set P direction of B-R.

**COLOR B-G**

NEGATIVE [-31 to +31]	Set N direction of B-G.
POSITIVE [-31 to +31]	Set P direction of B-G.

**Factory settings:** 0

**<NOTE>**

- The [LINEAR MATRIX] and [COLOR CORRECTION] setting screen opens in a separate window when you click the icon next to [Matrix/Color correction].

**PRESET MATRIX**

**[NORMAL, CINEMA1, CINEMA2, USER, HD]**

Select the type of matrix.

NORMAL	Standard matrix setting.
CINEMA1	High contrast matrix setting.
CINEMA2	Sedate matrix setting.
USER	Matrix setting conforming to Panasonic remote camera AW-UE150. Use this setting to match color reproducibility with AW-UE150.
HD	Matrix setting conforming to Panasonic broadcasting devices.

**Factory settings:** HD

**MATRIX [OFF, ON]**

Set ON/OFF for the matrix (linear matrix/color correction).

**Factory settings:** OFF

**LINEAR MATRIX [OFF, ON]**

Set ON/OFF for the linear matrix function.

**Factory settings:** OFF

**LINEAR TABLE [A, B]**

Select the table for the linear matrix.

**Factory settings:** A

**COLOR CORRECT [OFF, ON]**

Set ON/OFF for the color correction function.

**Factory settings:** OFF

**COLOR CORRECT TABLE [A, B]**

Select the table for color correction.

**Factory settings:** A



**COLOR B\_MG**

PHASE [-127 to 0 to 126]	Adjusts the hue between blue and magenta.
--------------------------	---

**COLOR MG**

PHASE [-127 to 0 to 126]	Adjusts the hue of magenta.
--------------------------	-----------------------------

**COLOR MG\_R**

PHASE [-127 to 0 to 126]	Adjusts the hue between magenta and red.
--------------------------	--

Factory settings: 0

**COLOR CORRECTION**

Make adjustments to the color saturation and hue.

**<NOTE>**

- For all of the COLOR CORRECTION items, setting is not possible when [V-LOG] is [On] and [V-LOG PAINT SW] is [Off].

**COLOR R**

PHASE [-127 to 0 to 126]	Adjusts the hue of red.
--------------------------	-------------------------

**COLOR R\_YE**

PHASE [-127 to 0 to 126]	Adjusts the hue between red and yellow.
--------------------------	---

**COLOR YE**

PHASE [-127 to 0 to 126]	Adjusts the hue of yellow.
--------------------------	----------------------------

**COLOR YE\_G**

PHASE [-127 to 0 to 126]	Adjusts the hue between yellow and green.
--------------------------	---

**COLOR G**

PHASE [-127 to 0 to 126]	Adjusts the hue of green.
--------------------------	---------------------------

**COLOR G\_CY**

PHASE [-127 to 0 to 126]	Adjusts the hue between green and cyan.
--------------------------	---

**COLOR CY**

PHASE [-127 to 0 to 126]	Adjusts the hue of cyan.
--------------------------	--------------------------

**COLOR CY\_B**

PHASE [-127 to 0 to 126]	Adjusts the hue between cyan and blue.
--------------------------	--

**COLOR B**

PHASE [-127 to 0 to 126]	Adjusts the hue of blue.
--------------------------	--------------------------

**GAMMA/KNEE**



**MASTER GAMMA [0.15 to 0.75]**

Adjust the master gamma correction level.

**Factory settings:** 0.45

**R GAMMA [-75 to +75]**

Set the gamma for the Rch.

**Factory settings:** 0

**B GAMMA [-75 to +75]**

Set the gamma for the Bch.

**Factory settings:** 0

**BLACK GAMMA [OFF, ON]**

Select ON/OFF for the gamma curve for dark areas.

**Factory settings:** OFF

**MASTER BLACK GAMMA [-48 to +48]**

Adjust the master black gamma correction level.

-48 to -1	Compresses dark parts.
+1 to +48	Expands dark parts.

**Factory settings:** 0

**R BLACK GAMMA [-20 to +20]**

Make adjustments to the black gamma correction level for the Rch.

**Factory settings:** 0

**B BLACK GAMMA [-20 to +20]**

Make adjustments to the black gamma correction level for the Bch.

**Factory settings:** 0

**BLACK GAMMA RANGE [1 to 3]**

Set the maximum level of compression/expansion for the gamma curve for dark areas.

1	About 20%
2	About 30%
3	About 40%

**Factory settings:** 1

**INITIAL GAMMA [4.0, 4.5, 5.0]**

Set the rising slope for the gamma curve.

This is only enabled when [GAMMA MODE SELECT] is set to [HD].

**Factory settings:** 4.0

● **GAMMA/BLACK GAMMA**

**<NOTE>**

- For all of the GAMMA/BLACK GAMMA items, setting is not possible when [V-LOG] is [On] and [V-LOG PAINT SW] is [Off].
- For all of the GAMMA/BLACK GAMMA items, setting is not possible when [HDR] is [On].

**GAMMA [OFF, ON]**

Select ON/OFF for the gamma mode.

**Factory settings:** OFF

**GAMMA MODE SELECT**

[HD, NORMAL, CINEMA1, CINEMA2]

Select the gamma curve type.

HD	HD (High Definition) video gamma characteristic.
NORMAL	Standard gamma characteristic.
CINEMA1	High contrast gamma characteristic.
CINEMA2	Sedate gamma characteristic.

**Factory settings:** HD

### ● KNEE

#### <NOTE>

- For all of the KNEE items, setting is not possible when [V-LOG] is [On] and [V-LOG PAINT SW] is [Off].
- For all of the KNEE items, setting is not possible when [HDR] is [On].

#### KNEE [OFF, ON]

Set ON/OFF for the operating mode for gradation compression (knee).

**Factory settings:** ON

#### KNEE MODE [AUTO, MANUAL]

Set the operating mode for gradation compression (knee).

AUTO	Automatically set the knee point and knee slope.
MANUAL	Manually set the knee point and knee slope.

**Factory settings:** AUTO

#### KNEE MASTER POINT

**[80.00% to 110.00% (0.25% step)]**

Set the compression level (knee point) position for high-brightness video signals.

This is only enabled when [KNEE MODE] is set to [MANUAL].

**Factory settings:** 0.95

#### KNEE R POINT

**[-25.00% to 25.00% (0.25% step)]**

Make positional settings for the compression level (knee point) of the Rch against the [KNEE MASTER POINT].

This is only enabled when [KNEE MODE] is set to [MANUAL].

**Factory settings:** 0

#### KNEE B POINT

**[-25.00% to 25.00% (0.25% step)]**

Make positional settings for the compression level (knee point) of the Bch against the [KNEE MASTER POINT].

This is only enabled when [KNEE MODE] is set to [MANUAL].

**Factory settings:** 0

#### KNEE MASTER SLOPE [00 to 199]

Set the incline of knee.

This is only enabled when [KNEE MODE] is set to [MANUAL].

**Factory settings:** 130

#### KNEE R SLOPE [-99 to +99]

Set the incline of the Rch against the [KNEE MASTER SLOPE].

This is only enabled when [KNEE MODE] is set to [MANUAL].

**Factory settings:** 0

#### KNEE B SLOPE [-99 to +99]

Set the incline of the Bch against the [KNEE MASTER SLOPE].

This is only enabled when [KNEE MODE] is set to [MANUAL].

**Factory settings:** 0

#### AUTO KNEE RESPONSE [1 to 8]

Set the speed of the auto knee response.

The response speed increases the lower the setting value.

**Factory settings:** 4

### ● WHITE CLIP

#### <NOTE>

- For all of the WHITE CLIP items, setting is not possible when [V-LOG] is [On] and [V-LOG PAINT SW] is [Off].
- For all of the WHITE CLIP items, setting is not possible when [HDR] is [On].

#### WHITE CLIP [OFF, ON]

Set ON/OFF for the white clip function.

**Factory settings:** OFF

#### MASTER WHITE CLIP LEVEL [80% to 109%]

Set the master white clip level.

**Factory settings:** 1.09

#### R WHITE CLIP LEVEL [-15% to +15%]

Set the white clip level of the Rch against the [MASTER WHITE CLIP LEVEL].

This is only enabled when [WHITE CLIP] is set to [ON].

**Factory settings:** 0

#### B WHITE CLIP LEVEL [-15% to +15%]

Set the white clip level of the Bch against the [MASTER WHITE CLIP LEVEL].

This is only enabled when [WHITE CLIP] is set to [ON].

**Factory settings:** 0

#### HI COLOR [OFF, ON]

Set the control of the mode to expand the dynamic range of colors. This improves the color reproducibility in very bright parts.

**Factory settings:** OFF

#### HI COLOR LEVEL [1 to 32]

Set the level of the mode to expand the dynamic range of colors.

**Factory settings:** 32

### ● DRS

#### <NOTE>

- For all of the DRS items, setting is not possible when [V-LOG] is [On] and [V-LOG PAINT SW] is [Off].

#### DRS [OFF, ON]

Set ON/OFF for the DRS function which makes appropriate corrections when recording video that has a large light/dark contrast.

**Factory settings:** OFF

#### EFFECT DEPTH [1 to 5]

Set the effect level of the DRS function. The effect level increases as the number increases.

**Factory settings:** 5





### CLIP(+) [00 to 63]

Set the level of clipping of the detail signal in the plus direction (brighter direction).

This is only enabled when [DETAIL] is set to [On].

**Factory settings:** 0

### CLIP(-) [00 to 63]

Set the level of clipping of the detail signal in the minus direction (darker direction).

This is only enabled when [DETAIL] is set to [On].

**Factory settings:** 0

### KNEE APERTURE LEVEL [00 to 39]

Adjust the level of detail for very bright parts.

This is only enabled when [DETAIL] is set to [On].

**Factory settings:** 0

### DETAIL KNEE [00 to 15]

Adjust the detail component of knee.

This is only enabled when [DETAIL] is set to [On].

**Factory settings:** 0

### LEVEL DEPRENDED SWITCH [Off, On]

Set On/Off for the level of reduction in detail in dark parts.

This is only enabled when [DETAIL] is set to [On].

**Factory settings:** Off

### LEVEL DEPENDENT [00 to 15]

Set the level of reduction in detail in dark parts.

This is only enabled when [DETAIL] is set to [On].

**Factory settings:** 0

### DARK DETAIL SWITCH [Off, On]

Set On/Off for the control that adds detail in dark parts.

This is only enabled when [DETAIL] is set to [On].

**Factory settings:** Off

### DARK DETAIL [0 to 7]

Set the level of detail in dark parts.

This is only enabled when [DETAIL] is set to [On].

**Factory settings:** 3

## ● DOWNCON SETTING

Adjust the contours and colors of images down-converted from 4K to HD.

This is enabled when [Format] is one of the following:

2160/59.94p, 2160/29.97p, 2160/23.98p, 2160/24p, 2160/50p, 2160/25p

### <NOTE>

- For all of the DOWNCON SETTING items, setting is not possible when [V-LOG] is [On] and [V-LOG PAINT SW] is [Off].

## CHROMA

### CHROMA LEVEL SWITCH [Off, On]

Set On/Off for the chroma level control.

**Factory settings:** Off

### CHROMA LEVEL [-100% to 40%]

Set here the color intensity (chroma level) of the images.

**Factory settings:** 0

## DETAIL SETTING

### DETAIL [Off, On]

Turn On/Off the contour (sharpness of images) adjustment of images.

**Factory settings:** On

### MASTER DETAIL [-31 to +31]

Make adjustments the contour correction level (master).

This is only enabled when [DETAIL] is set to [On].

**Factory settings:** 0

### H DETAIL LEVEL [00 to 63]

Adjust the contour correction level in the horizontal direction.

This is only enabled when [DETAIL] is set to [On].

**Factory settings:** 7

### V DETAIL LEVEL [00 to 63]

Adjust the contour correction level in the vertical direction.

This is only enabled when [DETAIL] is set to [On].

**Factory settings:** 7

### PEAK FREQUENCY [12.4MHz to 37.1MHz]

Set the boost frequency of detail.

This is only enabled when [DETAIL] is set to [On].

**Factory settings:** 22.4MHz

### V DETAIL FREQUENCY [00 to 31]

Set the boost frequency of detail (vertically).

00: Low frequency  
to

31: High frequency

When a high frequency is selected, the detail effect is added to subjects with more definition.

This is only enabled when [DETAIL] is set to [On].

**Factory settings:** 10

### CRISP [00 to 63]

Set the level of noise reduction for the detail signal.

This is only enabled when [DETAIL] is set to [On].

**Factory settings:** 10

### **CLIP(+)** [00 to 63]

Set the level of clipping of the detail signal in the plus direction (brighter direction).

This is only enabled when [DETAIL] is set to [On].

**Factory settings:** 0

### **CLIP(-)** [00 to 63]

Set the level of clipping of the detail signal in the minus direction (darker direction).

This is only enabled when [DETAIL] is set to [On].

**Factory settings:** 0

### **KNEE APERTURE LEVEL** [00 to 39]

Adjust the level of detail for very bright parts.

This is only enabled when [DETAIL] is set to [On].

**Factory settings:** 0

### **DETAIL KNEE** [00 to 15]

Adjust the detail component of knee.

This is only enabled when [DETAIL] is set to [On].

**Factory settings:** 0

### **LEVEL DEPENDED SWITCH** [Off, On]

Set On/Off for the level of reduction in detail in dark parts.

This is only enabled when [DETAIL] is set to [On].

**Factory settings:** Off

### **LEVEL DEPENDENT** [00 to 15]

Set the level of reduction in detail in dark parts.

This is only enabled when [DETAIL] is set to [On].

**Factory settings:** 8

### **DARK DETAIL SWITCH** [Off, On]

Set On/Off for the control that adds detail in dark parts.

This is only enabled when [DETAIL] is set to [On].

**Factory settings:** Off

### **DARK DETAIL** [0 to 7]

Set the level of detail in dark parts.

**Factory settings:** 2

### **SKIN TONE DETAIL** [Off, On]

This function smooths skin and produces a more beautiful image.

Set On/Off for the skin tone detail function.

**Factory settings:** Off

### **MEMORY SELECT** [Off, On]

Select the skin tone table of the subject for the skin tone effect.

**Factory settings:** Off

### **ZEBRA** [Off, On]

Set On/Off for the zebra display of the skin tone area.

The zebra pattern is displayed only on devices connected to the 3G SDI OUT2/PM connector.

**Factory settings:** Off

#### **<NOTE>**

- This cannot be set when [ZEBRA] in [SKIN TONE DETAIL SETTING] is [On].

### **ZEBRA EFFECT MEMORY**

**[A, B, C, A+B, A+C, B+C, A+B+C]**

Select the skin tone table for the zebra display.

**Factory settings:** A+B+C

### **SKIN TONE EFFECT MEMORY**

**[A, B, C, A+B, A+C, B+C, A+B+C]**

Select the skin tone table for the skin tone effect.

**Factory settings:** A+B+C

### **SKIN TONE CRISP** [0 to 8]

Adjust the skin tone detail.

**Factory settings:** 8

### **I CENTER** [000 to 255]

Set the central position above the I axis (area where skin tone is to take effect).

**Factory settings:** 65

### **I WIDTH** [000 to 255]

Set the width of the area where the skin tone is to take effect above the I axis, centered on [I CENTER].

**Factory settings:** 63

### **Q WIDTH** [000 to 127]

Set the width of the area where the skin tone is to take effect above the Q axis, centered on [I CENTER].

**Factory settings:** 32

### **Q PHASE** [0 to 359]

Set the phase of the area where skin tone is to take effect based on the Q axis.

**Factory settings:** 90

### ● SKIN TONE DETAIL SETTING

#### <NOTE>

- For all of the SKIN TONE DETAIL SETTING items, setting is not possible when [V-LOG] is [On] and [V-LOG PAINT SW] is [Off].

#### SKIN TONE DETAIL [Off, On]

This function smooths skin and produces a more beautiful image. Set On/Off for the skin tone detail function.

**Factory settings:** Off

#### MEMORY SELECT [A, B, C]

Select the skin tone table of the subject for the skin tone effect.

**Factory settings:** A

#### ZEBRA [Off, On]

Set On/Off for the zebra display of the skin tone area.

The zebra pattern is displayed only on devices connected to the 3G SDI OUT2/PM connector.

**Factory settings:** Off

#### <NOTE>

- This cannot be set when [ZEBRA] in [DOWNCON SETTING] is [On].

#### ZEBRA EFFECT MEMORY

##### [A, B, C, A+B, A+C, B+C, A+B+C]

Select the skin tone table for the zebra display.

**Factory settings:** A+B+C

#### SKIN TONE EFFECT MEMORY

##### [A, B, C, A+B, A+C, B+C, A+B+C]

Select the skin tone table for the skin tone effect.

**Factory settings:** A+B+C

#### SKIN TONE CRISP [-63 to 0 to +63]

Adjust the skin tone detail.

**Factory settings:** 63

#### I CENTER [000 to 255]

Set the central position above the I axis (area where skin tone is to take effect).

**Factory settings:** 65

#### I WIDTH [000 to 255]

Set the width of the area where the skin tone is to take effect above the I axis, centered on [I CENTER].

**Factory settings:** 63

#### Q WIDTH [000 to 255]

Set the width of the area where the skin tone is to take effect above the Q axis, centered on [I CENTER].

**Factory settings:** 32

#### Q PHASE [0 to 359]

Set the phase of the area where skin tone is to take effect based on the Q axis.

**Factory settings:** 90

### ■ Monitor display setting display [Monitor Display]

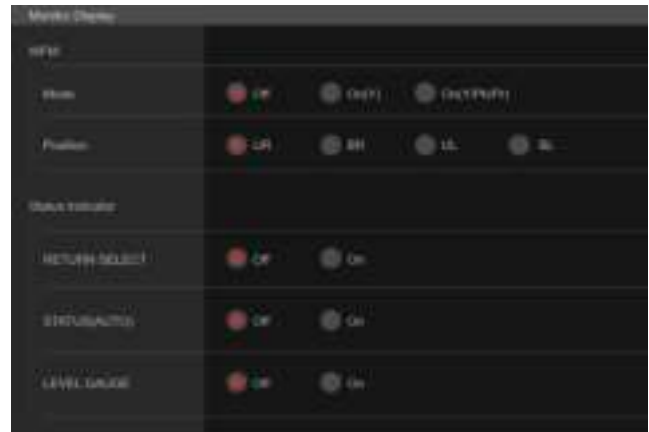

#### WFM

##### Mode [Off, On(Y), On(Y/Pb/Pr)]

Switch between displaying and hiding the WaveForm.

Off	WaveForm not displayed.
On(Y)	Waveform of Y component only displayed.
On(Y/Pb/Pr)	Waveform of Y, Pb, and Pr components each displayed.

**Factory settings:** Off

##### Position [UR, BR, BL, UL]

Select the area for displaying the WaveForm.

UR	Display WaveForm in the top right area.
BR	Display WaveForm in the bottom right area.
BL	Display WaveForm in the bottom left area.
UL	Display WaveForm in the top left area.

**Factory settings:** UR

#### <NOTE>

- The WaveForm is displayed only on devices connected to the 3G SDI OUT2/PM connector, and is not displayed on devices connected to the connectors of other output systems.

#### Status Indicator

For items that have been set to [On], when the designated status is reached and where [CHAR] is [ON], the statuses are displayed in the images of connectors where [OUTPUT ITEM] is set to [STATUS].

##### RETURN SELECT [Off, On]

When [On], the character string set in [RETURN] – [RETURN1 ID] is displayed as OSD in the region at the top center of the screen.

The RETURN SELECT character string is displayed only on devices connected to the 3G SDI OUT2/PM connector.

##### STATUS(AUTO) [Off, On]

When [On], the following status indications are displayed on the OSD:

- Display of the results after auto white balance is run
- Display of the results after auto black balance is run
- Error display when an error occurs

**Factory settings:** Off

**LEVEL GAUGE [Off, On]**

When [On], the status of the incline (horizontally, to the left or right or front and back) of the unit installation is displayed as OSD in the top left of the screen.

**Factory settings:** Off

(Example)  
 L↑ +3.2/-3.2↓R  
 F↓ -1.8/+1.8↑F

In the case of the display above, the unit is installed at an inclination of 3.2° upward to the left and 1.8° upward in to the front. The maximum incline is ±9.9°, and when there is an incline of 10° or greater, the display shows “±9.9”.

**<NOTE>**

- This is displayed only through the SDI, HDMI, SMPTE ST2110, and High bandwidth NDI outputs. It is not displayed with IP transmission (H.264/H.265/M-JPEG).
- The LEVEL GAUGE value is not updated during PAN/TILT operation.

**■ Lens setting screen [Lens]**

The setting is confirmed with the [Set] button.

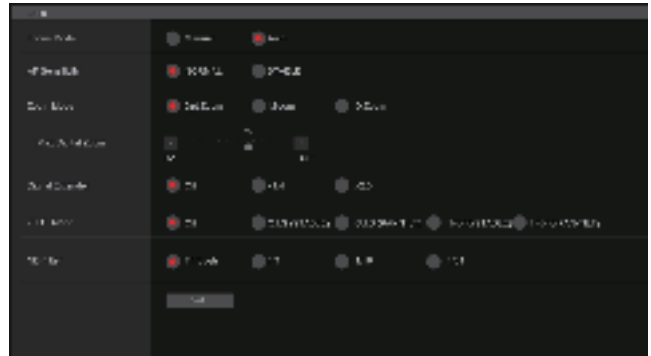

**Focus Mode [Manual, Auto]**

Select auto or manual mode for the focus adjustment function.

Manual	Adjust focus manually.
Auto	Always adjust focus automatically.

**Factory settings:** Auto

**AF Sensitivity [NORMAL, STABLE]**

Select the conformability mode for auto focusing function.

NORMAL	Focusing is with a standard conformability.
STABLE	Focusing is with a priority placed on stability.

**Factory settings:** NORMAL

**Zoom Mode [Opt.Zoom, i.Zoom, D.Zoom]**

Set the maximum magnification rate for zoom.

Opt.Zoom	Use only optical zoom. Optical zoom up to 20× is possible.
i.Zoom	Enable the i.Zoom function. When this function is enabled, digital zoom is used while reducing image degradation. <b>When [Basic Config] – [Format] is 2160/59.94p, 2160/29.97p, 2160/50p, 2160/25p, 2160/24p, 2160/23.98p</b> Up to 28× zoom is possible combining optical zoom and digital zoom. • When [Basic Config] – [Format] is other than one of these, up to 32× zoom is possible combining optical zoom and digital zoom.
D.Zoom	Enable the digital zoom function. Higher digital zoom magnifications will result in coarser images.

**Factory settings:** Opt.Zoom

**Max Digital Zoom**

[×2, ×3, ×4, ×5, ×6, ×7, ×8, ×9, ×10]

Set the maximum digital zoom magnification.

This is only enabled when [Zoom Mode] is set to [D.Zoom].

**Factory settings:** ×10

**<NOTE>**

- Higher digital zoom magnifications will result in coarser images.

## Web screen configurations (continued)

### Digital Extender [Off, ×1.4, ×2.0]

Make settings for the digital extender function.

Off	Turn the digital extender function Off.
×1.4	The digital zoom will be fixed at 1.4×.
×2.0	The digital zoom will be fixed at 2.0×.

This is only enabled when [Zoom Mode] is set to [Opt.Zoom].

**Factory settings:** Off

### O.I.S. Mode

#### [Off, O.I.S.(STABLE), O.I.S.(PAN/TILT), Hybrid(STABLE), Hybrid(PAN/TILT)]

Sets the mode for optical image stabilization (O.I.S.) and roll direction electronic image stabilization (E.I.S.).

Off	Turns the optical image stabilization (O.I.S.) function and roll direction electronic image stabilization (E.I.S.) function Off.
O.I.S. (STABLE)	Turns the optical image stabilization (O.I.S.) function On. Use with a pan/tilt fixed shooting scene.
O.I.S. (PAN/TILT)	Turns the optical image stabilization (O.I.S.) function On. Use with a scene for increasing the image stabilization effect during a shooting while performing the pan/tilt operation.
Hybrid (STABLE)	Turns the optical image stabilization (O.I.S.) function and roll direction electronic image stabilization (E.I.S.) function On. Use with a pan/tilt fixed shooting scene.
Hybrid (PAN/TILT)	Turns the optical image stabilization (O.I.S.) function and roll direction electronic image stabilization (E.I.S.) function On. Use with a scene for increasing the image stabilization effect during a shooting while performing the pan/tilt operation.

**Factory settings:** Off

#### <NOTE>

- In [O.I.S.(STABLE)] or [Hybrid(STABLE)] mode, the optical image stabilization (O.I.S.) function's level of correction is reduced during pan/tilt operations in order to minimize the convergence resulting from image stabilization during pan/tilt operations.
- In [O.I.S.(PAN/TILT)] or [Hybrid(PAN/TILT)] mode, as importance is given to heighten the image stabilization effect during pan/tilt operations, the convergence resulting from image stabilization during pan/tilt control may be a cause for concern in some scenes. Use [O.I.S.(STABLE)] or [Hybrid(STABLE)] for scenes where the convergence resulting from image stabilization needs to be restrained.

### ND Filter [Through, 1/4, 1/16, 1/64]

Set the transmittance of the lens' built-in ND (neutral density) filter. The filter switches when the setting is fixed.

Through	Do not set ND filter.
1/4	Set ND filter transmittance to 1/4.
1/16	Set ND filter transmittance to 1/16.
1/64	Set ND filter transmittance to 1/64.

#### <NOTE>

- This is only enabled when [PAINT] – [GAIN SETTING] – [DAY/ NIGHT] is set to [DAY].

### ■ UHD crop setting screen [UHD Crop]

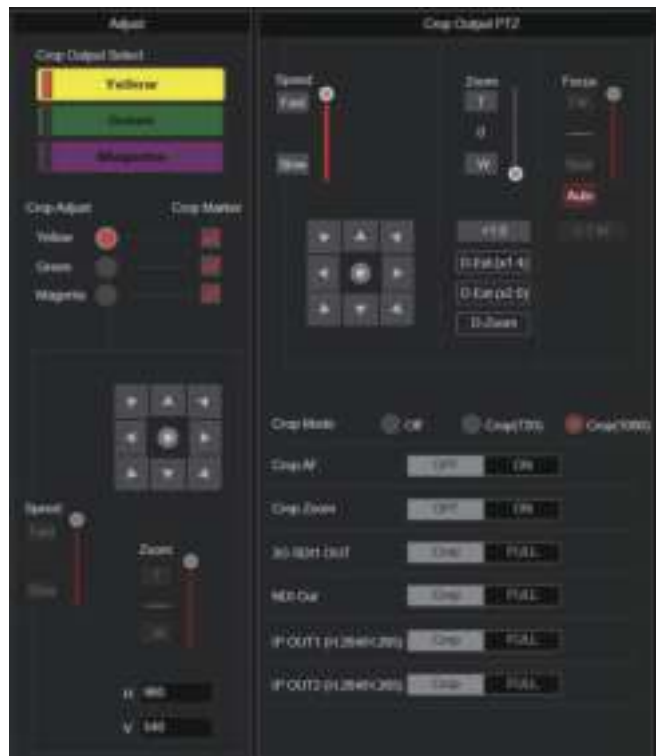

#### Crop Output PTZ

This is used for camera control. The same operations are possible as with the camera controller operated in the live screen [Live]. (→ page 107)

#### Crop Mode [Off, Crop(720), Crop(1080)]

Sets the Crop function which crops UHD(3840×2160) images.

Off	No cropping.
Crop(720)	Cropped images output with 720 resolution.
Crop(1080)	Cropped images output with 1080 resolution.

**Factory settings:** Off

#### <NOTE>

- When [Crop Mode] is changed, IP video transmission is temporarily stopped.
- Only when [2160/59.94p] or [2160/50p] is selected in [Basic Config] – [Format] are [Off], [Crop(1080)], and [Crop(720)] available for selection, and when [2160/60p], [2160/29.97p], [2160/25p], [2160/24p] or [2160/23.98p] is selected, [Off] and [Crop(1080)] only may be selected. When other selections are made in FORMAT, this will be [Off].
- When [Crop Mode] is [Crop(720)] or [Crop(1080)], the following values cannot be set in [Streaming mode]. H.264(UHD), U.265(UHD), JPEG(UHD), RTMP(UHD), SRT(H.264 UHD), SRT(H.265 UHD), NDI|HX V2(UHD) (→ page 125)
- When H.264(UHD), U.265(UHD), JPEG(UHD), RTMP(UHD), SRT(H.264 UHD), SRT(H.265 UHD) or NDI|HX V2(UHD) is selected in [Streaming mode] and [Crop Mode] is switched to [Crop(720)] or [Crop(1080)], the [Streaming mode] setting changes to [H.264].
- When [Crop Mode] is [Crop(720)] or [Crop(1080)], [Zoom Mode] is disabled and functions as [Opt.Zoom].

#### Crop AF [OFF, ON]

Make settings about whether to run AF on images within the crop frame.

This is only enabled when [Crop Mode] is set to [Crop(720)] or [Crop(1080)].



## Web screen configurations (continued)

### Crop Zoom [OFF, ON]

Make settings about whether to run cropping that uses D-Zoom. When [ON], you can set the Zoom magnification. (→ "Crop Zoom Ratio")  
This is only enabled when [Crop Mode] is set to [Crop(720)] or [Crop(1080)].

**Factory settings:** OFF

#### Zoom (Crop Zoom Ratio) [120.00% to 500.00%]

Specifies the size of the crop frame when [Crop Zoom] is [ON]. The crop zoom ratio can be specified between the range of 120.00% to 500.00%, and the grain-size can be set in units of 10.00% from the OSD menu.

The variable range of the setting value of this item, the crop frame size, [Crop H Position] and [Crop V Position] is shown below.

Crop Zoom Ratio	Crop frame size	Variable range	
		Crop H Position	Crop V Position
120.00%	3200×1800	0 to 640	0 to 360
⋮	⋮	⋮	⋮
200.00%	1920×1080	0 to 1920	0 to 1080
⋮	⋮	⋮	⋮
300.00%	1280×720	0 to 2560	0 to 1440
⋮	⋮	⋮	⋮
400.00%	960×540	0 to 2880	0 to 1620
⋮	⋮	⋮	⋮
500.00%	768×432	0 to 3072	0 to 1728

This is only enabled when [Crop Mode] is set to [Crop(720)] or [Crop(1080)].

This is only enabled when [Crop Zoom] is set to [ON].

**Factory settings:** 200.00%

### 3G SDI OUT [FULL, Crop]

Make the settings for FULL/Crop for images output to the 3G SDI OUT1 connector.

FULL	FHD down-converted images are output as is without cropping UHD images.
Crop	Images with FHD cropped from UHD images are output. The images output in this case are those with the crop frame specified in [Crop Output Select].

This is only enabled when [Crop Mode] is set to [Crop(720)] or [Crop(1080)].

**Factory settings:** Crop

### NDI Out [FULL, Crop]

Makes the settings for FULL/Crop for images output to High bandwidth NDI transmission.

FULL	FHD down-converted images are output as is without cropping UHD images.
Crop	Images with FHD cropped from UHD images are output. The images output in this case are those with the crop frame specified in [Crop Output Select].

This is only enabled when [Crop Mode] is set to [Crop(720)] or [Crop(1080)].

**Factory settings:** Crop

### IP OUT1 (H.264/H.265) [FULL, Crop]

### IP OUT2 (H.264/H.265) [FULL, Crop]

Makes the settings for FULL/Crop for images output to H.264/H.265/M-JPEG transmission (LAN connector).

Setting specified in [IP OUT1 (H.264/H.265)] is applied to images transmitted by each transmission CH1(H.264(1), H.265(1), JPEG(1)). Setting specified in [IP OUT2 (H.264/H.265)] is applied to images transmitted by each transmission CH2 to CH3(H.264(2) to (3), H.265(2) to (3), JPEG(2) to (3)).

FULL	FHD down-converted images are output as is without cropping UHD images.
Crop	Images with FHD cropped from UHD images are output. The images output in this case are those with the crop frame specified in [Crop Output Select].

This is only enabled when [Crop Mode] is set to [Crop(720)] or [Crop(1080)].

When the [Streaming mode] on the web screen is [NDI|HX V2], [IP OUT1 (H.264/H.265)] and [IP OUT2 (H.264/H.265)] will have a linked operation.

**Factory settings:** Crop

### Adjust

#### Crop Output Select [Yellow, Green, Magenta]

Make the settings for the crop frame images output to the 3G SDI OUT1 connector, cropped images of SMPTE ST2110, High bandwidth NDI images, and the LAN connector (H.264/H.265/M-JPEG).

Yellow	Output the yellow crop frame images.
Green	Output the green crop frame images.
Magenta	Output the magenta crop frame images.

This is only enabled when [Crop Mode] is set to [Crop(720)] or [Crop(1080)].

**Factory settings:** Yellow

#### <NOTE>

- The color frame specified in [Crop Output Select] will be a deeper shade when compared to other colors used for frames.
- Cropped images cannot be output with the 12G SDI OUT/SFP+ connector, 3G SDI OUT2/PM connector, HDMI connector, SMPTE ST2110 MAIN images, or SMPTE ST2110 MONITOR images.

#### Crop Marker [Off, Yellow, Green, Magenta, Yellow+Green, Yellow+Magenta, Green+Magenta, Yellow+Green+Magenta]

Make the settings for the crop frame displayed for images output to the 3G SDI OUT1 connector, the 3G SDI OUT2/PM connector, the MONITOR images of SMPTE ST2110, and the LAN connector (H.264/H.265/M-JPEG).

Off	Crop frame is not displayed.
Yellow	Only a yellow crop frame is displayed.
Green	Only a green crop frame is displayed.
Magenta	Only a magenta crop frame is displayed.
Yellow+Green	Yellow and green crop frames are displayed.
Yellow+Magenta	Yellow and magenta crop frames are displayed.
Green+Magenta	Green and magenta crop frames are displayed.
Yellow+Green+Magenta	Yellow, green, and magenta crop frames are displayed.

This is only enabled when [Crop Mode] is set to [Crop(720)] or [Crop(1080)].

**Factory settings:** Yellow+Green+Magenta

### Crop Adjust [Yellow, Green, Magenta]

Make selections for the crop frame to adjust positioning.

Yellow	Make position adjustments for the yellow crop frame.
Green	Make position adjustments for the green crop frame.
Magenta	Make position adjustments for the magenta crop frame.

This is only enabled when [Crop Mode] is set to [Crop(720)] or [Crop(1080)].

**Factory settings:** Yellow

**<NOTE>**

- The color frame specified in [Crop Adjust] will be thicker when compared to other color frames.

#### H [0 to 3072]

Make settings for the position in the horizontal direction for the crop frame specified in [Crop Adjust].

The variable range is 0 to 1920 when [Crop Mode] is [Crop(1080)] and [Crop Zoom] is [OFF], with 0 as the left edge and 1920 as the right edge, and only even numbers can be set.

The variable range is 0 to 2560 when [Crop Mode] is [Crop(720)] and [Crop Zoom] is [OFF], with 0 as the left edge and 2560 as the right edge, and only even numbers can be set.

The variable range when [Crop Zoom] is [ON] is different depending on the setting value of [Zoom (Crop Zoom Ratio)], with the variable range being 0 to 3072 when the [Zoom (Crop Zoom Ratio)] is 500.00%, and only even numbers can be set.

This is only enabled when [Crop Mode] is set to [Crop(720)] or [Crop(1080)].

**Factory settings:** 960

#### V [0 to 1728]

Make settings for the position in the vertical direction for the crop frame specified in [Crop Adjust].

The variable range is 0 to 1080 when [Crop Mode] is [Crop(1080)] and [Crop Zoom] is [OFF], with 0 as the upper edge and 1080 as the lower edge.

The variable range is 0 to 1440 when [Crop Mode] is [Crop(720)] and [Crop Zoom] is [OFF], with 0 as the upper edge and 1440 as the lower edge.

The variable range when [Crop Zoom] is [ON] is different depending on the setting value of [Zoom (Crop Zoom Ratio)], with the variable range being 0 to 1728 when the [Zoom (Crop Zoom Ratio)] is 500.00%.

This is only enabled when [Crop Mode] is set to [Crop(720)] or [Crop(1080)].

This is only enabled when [Crop Zoom] is set to [ON].

**Factory settings:** 540

### ■ Preset position screen [Preset position]





### Preset

The setting is confirmed with the [SET] button.



	When a preset thumbnail is clicked, the camera moves to face towards a preset position that was registered beforehand. You can select [Home] and [Preset001] to [Preset100]. Preset numbers are displayed in green when they have had a preset position registered in them.
	Preset names are displayed. During the preset registration mode, you can select a preset name and change the display name. You can enter between 1 to 15 characters. The characters available are 0 to 9, A to Z, a to z, spaces, and underscores (_).
	Switches the page of the displayed preset thumbnails.
	Move to home position.
	The unit moves to the preset registration mode. When a preset thumbnail is clicked in the preset registration mode, it is registered in the preset position specified by the current condition.
	The unit moves to the preset delete mode. When a preset thumbnail is clicked in the preset delete mode, the specified preset position settings are deleted.

	[Save]
Acquire JPEG images (still images) and save them. They can be saved by specifying [PICT001] to [PICT100] or [STIL001] to [STIL005] in the save destination. If [PICT***] is selected, the thumbnail image for the corresponding preset number can be updated, and if [STIL001] to [STIL005] is selected, you can save still images with a higher resolution. Furthermore, when [STIL001] to [STIL005] have been selected, the [Load] and [DEL] buttons are activated and it is possible to load and delete the still images you have saved.	

### ● Limitation Setting

This establishes the up, down, left and right limit settings of the pan-tilt head.

First, use the control pad to rotate the pan-tilt head to the position you want to set as the limit.

After the limit position has been selected, click the buttons corresponding to the following items to confirm.

The setting is cleared if the button is pressed again.

Tilt Up	Use this to save the current position as the upward limit.
Tilt Down	Use this to save the current position as the downward limit.
Pan Left	Use this to save the current position as the leftward limit.
Pan Right	Use this to save the current position as the rightward limit.

### ● Pan/Tilt Lens Control

This is used for camera control. The same operations are possible as with the camera controller operated in the live screen [Live].

(→ page 107)

### ● Preset Setting

#### Preset Speed Unit [Speed Table, Time]

When reproducing the information such as camera direction registered in the preset memory, you can select whether to specify the playback time by speed or by time.

Speed Table	Specify the speed when playing during preset playback.
Time	Specify the time when playing during preset playback.

**Factory settings:** Speed Table

#### Preset Speed Table [Slow, Fast]

Set the preset speed table (Slow, Fast). During preset playback, presets are performed at [Preset Speed] (1 to 30) values that are based on the table set here.

This is only enabled when [Preset Speed Unit] is set to [Speed Table].

**Factory settings:** Fast

#### Preset Speed [1 to 30/1s to 99s]

##### When [Preset Speed Unit] is [Speed Table]: [1 to 30]

Set the pan/tilt operation speed in 30 steps when playing back the preset memory.

**Factory settings:** 20

<NOTE>

- When you set large [Preset Speed] values, the image may sway when the movement stops.

##### When [Preset Speed Unit] is [Time]: [1s to 99s]

Set the pan/tilt operation time between 1 and 99 seconds when playing back the preset memory.

**Factory settings:** 20s

<NOTE>

- Depending on the movement distance of pan/tilt, there may be a difference compared to the specified time.

#### Preset Acceleration [Manual, Auto]

Sets whether to perform advance setting for acceleration and deceleration speed etc. during start/stop of preset playback.

Manual	Makes the advance settings for acceleration speed etc. when starting/stopping preset playback.
Auto	Automatically operates acceleration speed etc. when starting/stopping preset playback.

**Factory settings:** Auto

#### Rise S-Curve [0 to 30]

Sets the S-curve for pan/tilt acceleration operation in 31 steps. (The greater the number, the steeper the S-curve)

During the acceleration operation for operating at the specified speed or time during pan/tilt operations by preset playback, the acceleration process is performed using the S-curve specified in this setting.

This is enabled only when [Preset Acceleration] is [Manual].

**Factory settings:** 15

<NOTE>

- In order to limit the acceleration response, in the S-curve step, as the acceleration speed rises, the limit is automatically applied.

#### Fall S-Curve [0 to 30]

Sets the S-curve for pan/tilt deceleration operation in 31 steps. (The greater the number, the steeper the S-curve)

During the fall acceleration operation for operating at the specified speed or time during pan/tilt operations by preset playback, the deceleration process is performed using the S-curve specified in this setting.

This is enabled only when [Preset Acceleration] is [Manual].

**Factory settings:** 15

<NOTE>

- In order to limit the deceleration response, in the S-curve step, as the deceleration speed rises, the limit is automatically applied.

#### Rise Acceleration [1 to 255]

Sets the acceleration speed for pan/tilt acceleration operation in 255 steps. (The acceleration speed increases as the number increases.) During the acceleration operation for operating at the specified speed or time during pan/tilt operations by preset playback, the acceleration process is performed using the acceleration speed specified in this setting.

This is enabled only when [Preset Acceleration] is [Manual] and [Preset Speed Unit] is [Speed Table].

**Factory settings:** 128

<NOTE>

- As the speed specified for [Preset Speed] is given priority as the maximum speed attained in preset playback, if the acceleration speed specified here is small, this functionality may not operate as specified.

#### Fall Acceleration [1 to 255]

Sets the deceleration speed for pan/tilt deceleration operation in 255 steps. (The deceleration speed increases as the number increases.) During the deceleration operation for operating at the specified speed or time during pan/tilt operations by preset playback, the deceleration process is performed using the deceleration speed specified in this setting.

This is enabled only when [Preset Acceleration] is [Manual] and [Preset Speed Unit] is [Speed Table].

**Factory settings:** 128

<NOTE>

- As the speed specified for [Preset Speed] is given priority as the maximum speed attained in preset playback, if the deceleration speed specified here is small, this functionality may not operate as specified.

#### Rise Ramp Time [0.1s to 10.0s]

Sets the acceleration time for the time specific operation during preset playback. (Sets between 0.1s to 10.0s in 0.1s increments)

This is enabled only when [Preset Acceleration] is [Manual] and [Preset Speed Unit] is [Time].

**Factory settings:** 0.1s

<NOTE>

- As the time specified in [Preset Speed] takes precedence as the total time for preset playback, if the time specified here is more than half of the time specified in [Preset Speed], this functionality will not operate as specified.
- When the acceleration operation cannot be performed within the specified time even at maximum acceleration speed of the device, the operation will not be performed by the specified time.

#### Fall Ramp Time [0.1s to 10.0s]

Sets the deceleration time for time specified operations during preset playback. (Sets between 0.1s to 10.0s in 0.1s increments)

This is enabled only when [Preset Acceleration] is [Manual] and [Preset Speed Unit] is [Time].

**Factory settings:** 0.1s

<NOTE>

- As the time specified in [Preset Speed] takes precedence as the total time for preset playback, if the time specified here is more than half of the time specified in [Preset Speed], this functionality will not operate as specified.
- When the deceleration operation cannot be performed within the specified time even at maximum fall deceleration of the device, the operation will not be performed by the specified time.

### Preset Scope [Mode A, Mode B, Mode C]

Selected here are the setting items to be recalled when the contents of the preset memory are regenerated.

Mode A	Pan, Tilt, Zoom (including digital zoom), Focus, Iris, Gain, Shutter, white balance adjustment value
Mode B	Pan, Tilt, Zoom (including digital zoom), Focus, Iris
Mode C	Pan, Tilt, Zoom (including digital zoom), Focus

**Factory settings:** Mode A

### Preset Digital Extender [Off, On]

Turns the preset digital extender function Off/On.

When set to [On], the digital extender function configuration will be recalled when regenerating the preset memory.

When set to [Off], the digital extender function configuration will not be recalled when storing the preset memory.

**Factory settings:** Off

### Preset Crop [Off, On]

When the preset memory is played back, set whether the reproduction of content set in the various [Crop Mode] menus is Off/On.

When set to [On], the content set in the various [Crop Mode] menus is reproduced when preset memory is played back.

When set to [Off], the content set in the various [Crop Mode] menus is not reproduced when preset memory is played back, with the current values being kept.

**Factory settings:** Off

#### <NOTE>

- This is only enabled when [Crop Mode] is set to [Crop(720)] or [Crop(1080)].
- When [Crop Mode] is [Off] or [Crop(1080)] and preset memory is registered and preset playback is executed when [Crop Mode] is [Crop(720)], then, even if [Preset Crop] is [On], the content set in each menu of [Crop Mode] is not recalled.
- When [Crop Mode] is [Crop(720)] and preset memory is registered and preset playback is executed when [Crop Mode] is [Crop(1080)], then, even if [Preset Crop] is [On], the content set in each menu of [Crop Mode] is not recalled.

### Preset Thumbnail Update [Off, On]

Turn Off/On the function for registering the still image (thumbnail) for the images being output when a preset memory is registered.

When set to [On], the still image (thumbnail) for the images being output is registered when registering a preset memory.

When set to [Off], the still image (thumbnail) for the images being output is not registered when registering a preset memory, but rather the still image (thumbnail) previously registered is maintained.

**Factory settings:** On

#### <NOTE>

- When [IP SIGNAL] – [IP(H.264/H.265)] – [CHAR] is [On], the menu screen is imported into the thumbnails.
- When [Crop Mode] is [Crop(720)] or [Crop(1080)], the cropped still image is registered rather than the Full image.
- Still images (thumbnails) registered in the preset memory are deleted when user files are uploaded with a web screen, etc. (→ page 189)
- When continuous registration of preset memories is performed (continuous registration within 3 seconds), still images (thumbnails) for the second preset memory may not be registered, with black still images (thumbnails) being used instead.

### Preset Name [Reset, Hold]

When registering a preset memory, set whether to reset the previously registered preset name or keep it.

Reset	When registering a preset memory, reset the previously registered preset name. The preset name after resetting will be [Preset***]. (***) is a 3 digit preset number: 001 to 100)
Hold	When registering a preset memory, keep the previously registered preset name.

**Factory settings:** Reset

#### <NOTE>

- The factory default setting for the preset name is [Preset\*\*\*]. (\*\*\*) is a 3 digit preset number: 001 to 100)
- The registration of preset names can be done in the web browser. 0 to 9, A to Z, a to z, \_ , and space

### Preset Iris [Off, On]

When the preset memory is played back, set whether the reproduction of the values in the various menus related to Iris is off/on.

When set to [On], the values set in the various menus below are reproduced when preset memory is played back.

- [PAINT] – [IRIS] – [AUTO IRIS]
- [PAINT] – [IRIS] – [WINDOW SELECT]
- [PAINT] – [IRIS] – [PICTURE LEVEL]
- [PAINT] – [IRIS] – [IRIS SPEED]

**Factory settings:** Off

#### <NOTE>

- Its setting takes effect when [Mode A] or [Mode B] has been selected as the [Preset Scope] setting.

### Preset Shutter [Off, On]

When the preset memory is played back, set whether the reproduction of the SHUTTER setting value is Off/On.

#### <NOTE>

- This is only enabled when [Preset Scope] is set to [Mode A].
- SHUTTER values are reproduced only when the frame rate when the preset memory was registered and the frame rate when playing back the preset memory match.

### Preset Zoom Mode [Mode A, Mode B]

Select the zoom operation for when preset memory is recalled.

Mode A	Perform smooth zoom operation to match the behavior of pan/tilt.
Mode B	Perform constant speed zoom operation to match the behavior of pan/tilt.

**Factory settings:** Mode A

### Freeze During Preset [Off, On]

Turn the function for freezing images during preset playback off/on.

When this is set to [On], preset playback is performed with a still of the image immediately preceding the start of preset playback being output. The image freeze is released when preset playback is finished.

**Factory settings:** Off

Collaboration capability [Linkage]

■ Tracking data output settings screen [Tracking Data Output]

Select the output mode of the tracking data and the communication destination in the IP mode.  
Up to four addresses can be specified when the IP mode is enabled.

● Setting status

Displays the output mode of tracking data and the destinations in IP mode.

Setting status		
Connection type	Serial	IP(UDP)
	Off	Off
IP out	IP address	Port
1.	192.168.0.111	1111
2.	192.168.0.112	1112
3.	192.168.0.113	1113
4.	192.168.0.114	1114

● Connection type

Connection type

Camera ID: 255

Serial:  On  Off

IP(UDP):  On  Off

Invert Pan/Tilt Axis:  On  Off

Camera ID [0 to 255]

Sets the Camera ID for tracking data.  
Factory settings: 255

Serial [On, Off]

Sets the function [On] or [Off] to output the tracking data, such as Pan/Tilt/Zoom or other information from Serial Output (RS-422), synchronized with the Genlock signal. (→ page 71)  
When [Serial] is set to [On], a warning message is displayed. Click the [OK] button to enable the settings.

Factory settings: Off

<NOTE>

- The camera control commands are not output from the RS-422 connector when [Serial] is [On].
- In the following cases, the tracking data output may be delayed or the value may not be updated.
  - While viewing the OSD menu
  - While recalling the preset value during an ongoing preset recall
  - When executing AWB/ABB
  - When a red or a green tally signal input has been changed between Off and On
  - When deleting a preset memory
  - When an output image is flipped (turned upside down or left-right reversed)
  - After switching [SCENE]
  - After switching [IRIS]
  - After switching [WHITE BALANCE MODE]
  - After switching each item of [COLOR TEMP SETTING]
  - After switching [Gamma]
  - After switching [MATRIX]
  - After switching [FOCUS MODE]
  - After switching [Zoom Mode]
  - After switching [MAX DIGITAL ZOOM]
  - After switching [DIGITAL EXTENDER]
  - After switching [FAN SETTING]
  - After switching [Tally]
  - After moving the crop frame of [Crop Mode]
  - After switching [INSTALL POSITION]
  - After switching [Preset Speed Unit]
  - When executing [Reset to the default (Except the network settings)] of [Maintenance]

### IP(UDP) [On, Off]

Sets the UDP output function [On] or [Off] to output tracking data, such as Pan/Tilt/Zoom or other information from the IP output, synchronized with the Genlock signal. (→ page 71)

When [IP(UDP)] is set to [On], a warning message is displayed. Click the [OK] button to enable the settings.

**Factory settings:** Off

**<NOTE>**

- When [IP(UDP)] is [On], video transmission via IP may be delayed or the video may suffer frame loss.  
We recommend setting [IP(UDP)] to [Off] to avoid the delay or frame loss due to the video transmission via IP.
- In the following cases, the tracking data output may be delayed or the value may not be updated.
  - When performing video transmission via IP (M-JPEG/H.264/H.265/RTMP/RTMPS/NDI/NDI|HX/SRT)
  - When opening the web screen (live screen [Live] or the web setting screen [Setup])
  - While viewing the OSD menu
  - While recalling the preset value during an ongoing preset recall
  - When executing AWB/ABB
  - When a red or a green tally signal input has been changed between Off and On
  - When deleting a preset memory
  - When an output image is flipped (turned upside down or left-right reversed)
  - After switching [SCENE]
  - After switching [IRIS]
  - After switching [WHITE BALANCE MODE]
  - After switching each item of [COLOR TEMP SETTING]
  - After switching [Gamma]
  - After switching [MATRIX]
  - After switching [FOCUS MODE]
  - After switching [Zoom Mode]
  - After switching [MAX DIGITAL ZOOM]
  - After switching [DIGITAL EXTENDER]
  - After switching [FAN SETTING]
  - After switching [Tally]
  - After moving the crop frame of [Crop Mode]
  - After switching [INSTALL POSITION]
  - After switching [Preset Speed Unit]
  - When executing [Reset to the default (Except the network settings)] of [Maintenance]

### Invert Pan/Tilt Axis [On, Off]

Sets whether to invert the Pan/Tilt data for output in the tracking data.

On	Pan/Tilt data is inverted for output.
Off	Pan/Tilt data is not inverted.

**Factory settings:** Off

### ● IP out



### Output client select [Client 1 to 4]

Enable or disable up to four clients to forward the tracking data when [IP(UDP)] is [On].

Forwards the tracking data via UDP such as Pan/Tilt/Zoom or other information to the clients that are set to enable on this screen.

The setting is confirmed with the [Set] button.

**Factory settings:**

- Client1: Disable
- Client2: Disable
- Client3: Disable
- Client4: Disable

**<NOTE>**

- Disable the client that does not require the forwarding of the tracking data because the UDP packet is transmitted to the enabled client at the system frequency interval.
- When multiple clients are enabled, the timing of transmitting the UDP packet to the second and subsequent clients will always be delayed relative to the Genlock signal.  
(Approximately 200 to 300  $\mu$ s delay will occur for each client. The latency may be increased depending on the system status or the network environment of the unit.)

### Client1 to 4

#### IP address(IPv4)

Sets the destination IP address to forward the tracking data such as Pan/Tilt/Zoom or other information via UDP.

The setting is confirmed with the [Set] button.

**Factory settings:**

- Client1: 192.168.0.111
- Client2: 192.168.0.112
- Client3: 192.168.0.113
- Client4: 192.168.0.114

**<NOTE>**

- The address to forward the tracking data can only be configured as IPv4.
- A multicast address cannot be specified for the destination address.

### Port

Sets the destination port number to forward the tracking data such as Pan/Tilt/Zoom or other information via UDP.

The setting is confirmed with the [Set] button.

The following port numbers are used by the unit so they cannot be used.

20, 21, 23, 25, 42, 53, 67, 68, 69, 80, 110, 123, 161, 162, 443, 554, 995, 10669, 10670, 59000 to 61000

### Factory settings:

Client1: 1111

Client2: 1112

Client3: 1113

Client4: 1114

### <NOTE>

- You cannot set up clients having a combination of two or more IP addresses with duplicated ports.

## ■ Kairos Cloud connection setting screen [Kairos Cloud]

Sets whether to enable or disable connection to Kairos Cloud, as well as the destination server URL and the user account.

The setting is confirmed with the [Set] button.

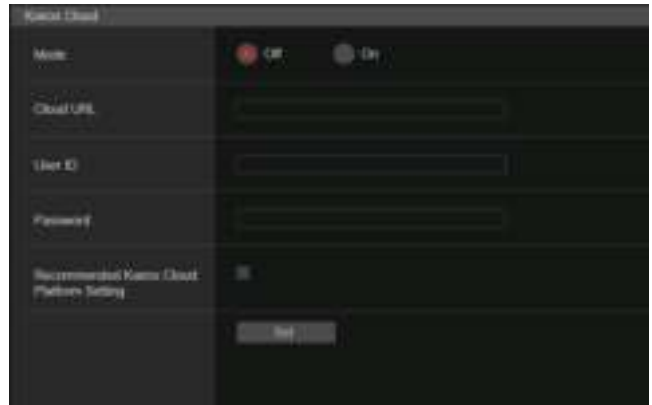

### Mode [On, Off]

Sets whether to connect this unit to Kairos Cloud via a network.

**Factory settings:** Off

### Cloud URL

Sets the server URL of Kairos Cloud to be connected when [Mode] is [On].

### <NOTE>

- You can set the URL with maximum 512 characters.

### User ID

Sets the user ID for connection to Kairos Cloud when [Mode] is [On].

### Password

Sets the password for connection to Kairos Cloud when [Mode] is [On].

### Recommended Kairos Cloud Platform Setting

Switches the settings of the unit automatically to the settings recommended for connection to the Kairos Cloud Platform.

### <NOTE>

- After changing to the recommended settings, the unit automatically restarts.

## Web screen configurations (continued)

### User management screen [User mng.]

The users and personal computers (IP addresses) that can access the unit from personal computers and mobile terminals are registered in the User management screen [User mng.].  
The User management screen [User mng.] consists of [User auth.] and [Host auth.].

### User authentication screen [User auth.]

Click the [User auth.] of User management screen [User mng.].  
Configure the user authentication settings for the personal computers and mobile terminals that can access the unit.  
Up to 9 users can be registered.

#### <NOTE>

- If user authentication fails more than 8 times within a 30-second period from the same IP address (personal computer), access to the unit will be disabled for a certain period.

#### ● Setting status

The current user authentication settings and user authentication method are displayed. The currently registered account information is also displayed.



#### ● Mode



#### User auth. [On, Off]

User authentication is set to [On] or [Off] here.  
The setting is confirmed with the [Set] button.

**Factory settings:** Off

#### Authentication [Basic, Digest]

Specify the method of user authentication to use.  
The setting is confirmed with the [Set] button.

Basic	Use basic authentication.
Digest	Use digest authentication.

**Factory settings:** Digest

#### Wait time mode [Mode1, Mode2]

Set the wait time mode for re-entry of user authentication after authentication fails when controlling the unit from a personal computer or a Panasonic controller.

Mode1	The wait time for re-entry is longer compared to [Mode2]. This is the setting recommended if security is to be prioritized.
Mode2	The wait time for re-entry is shorter. This is the setting recommended if operability is to be prioritized.

**Factory settings:** Mode1

#### <NOTE>

- When using a Panasonic controller (AW-RP150, AW-RP60), set [Wait time mode] to [Mode2] when using digest authentication. Smooth operation may be diminished when [Wait time mode] is set to [Mode1].

#### ● Add user

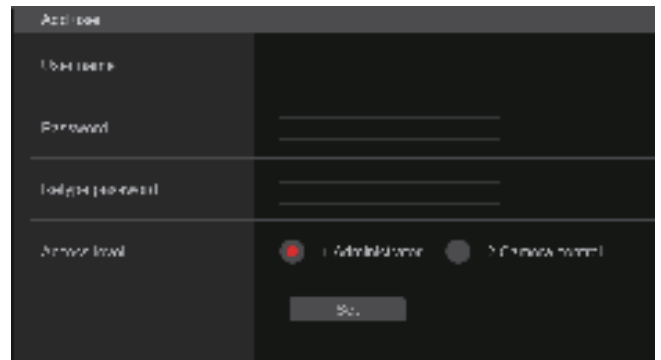

#### User name

##### [1 to 32 characters]

The user name is input here.

The setting is confirmed with the [Set] button.

- The following characters can be displayed.

Numeric characters	0123456789
Alphabetical characters (upper and lower cases)	ABCDEFGHIJKLMNOPQRSTUVWXYZabcdefghijklmnopqrstuvwxyz
Symbols	! \$ % ' ( ) * + , - . / ? @ [ ] ^ _ ` ~

#### Password

##### Retype password

##### [4 to 32 characters]

The password is input here.

The setting is confirmed with the [Set] button.

#### Access level [1.Administrator, 2.Camera control]

Select the user access level.

The setting is confirmed with the [Set] button.

1.Administrator	This access level allows the user to perform all the unit's operations.
2.Camera control	This access level allows only live screen [Live] operations to be performed.

**Factory settings:** 1.Administrator

#### ● Delete user

Delete the user accounts registered in the unit.

You can delete selected users by clicking the [Delete] button at the right.

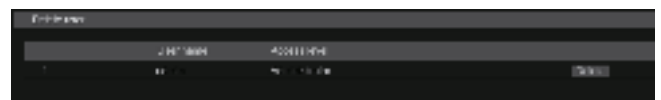



### ■ Host authentication screen [Host auth.]

Click the [Host auth.] of User management screen [User mng.].  
Configure the host authentication settings that restrict the personal computers (IP addresses) that can access the unit.

#### ● Setting status



#### Host auth.

The host authentication settings are displayed.

#### Host IP address

The host IP address is displayed.

#### Access level

The host access level is displayed.

#### ● Mode

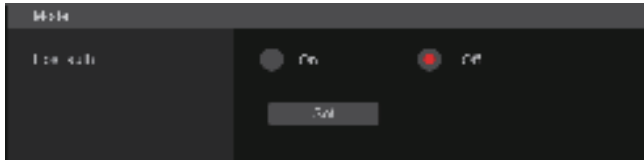

#### Host auth. [On, Off]

Host authentication is set to [On] or [Off] here.  
The setting is confirmed with the [Set] button.

**Factory settings:** Off

#### ● Add host

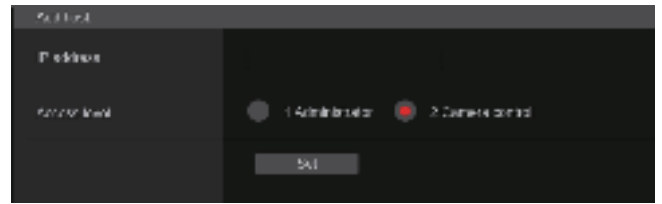

#### IP address

The IP address of the personal computer from which access to the camera is allowed is input here. The host name cannot be input as the IP address.

#### <NOTE>

- When the "IP address/subnet mask length" is input, the personal computers which are allowed to access the camera can be restricted on a subnet by subnet basis.  
If, for instance, "192.168.0.1/24" has been input and the [2. Camera control] setting has been selected as the [Access level] setting, the personal computers from "192.168.0.1" to "192.168.0.254" will be able to access the camera at the [2. Camera control] access level.
- When an already registered IP address is input and the [Set] button is clicked, the host information will be overwritten.

#### Access level [1.Administrator, 2.Camera control]

Select the host access level.

The setting is confirmed with the [Set] button.

1.Administrator	This access level allows the user to perform all the unit's operations.
2.Camera control	This access level allows you to display images and control the unit. The unit cannot be set.

**Factory settings:** 2.Camera control

#### ● Delete host

Delete the host information registered in the unit.

You can delete selected host information by clicking the [Delete] button at the right.

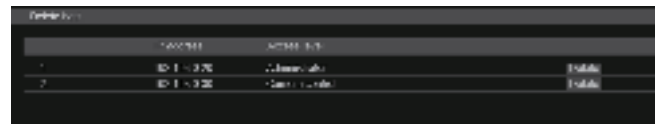



### Network setup screen [Network]

Configure network settings in the Network setup screen [Network]. The Network setup screen [Network] consists of [Network] and [Advanced].

### Network setup screen [Network]

Click the [Network] of the Network setup screen [Network]. Make the settings on the pages for the items.

The following information is required to configure network settings. Consult your network administrator or Internet service provider.

- IP address
- Subnet mask
- Default gateway (when using a gateway server or router)
- HTTP port
- DNS primary and secondary server addresses (when using DNS), domain

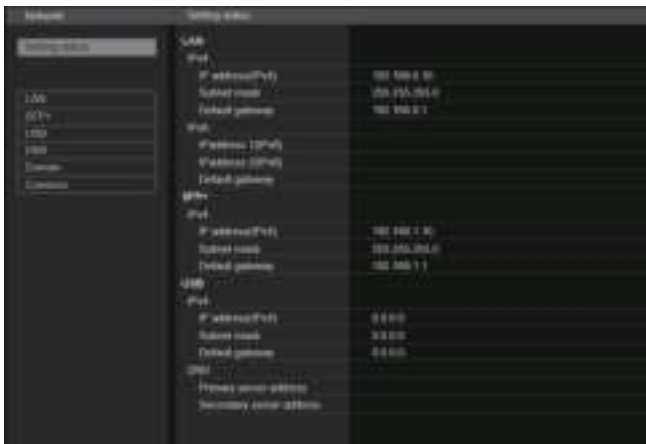

#### <NOTE>

- If the subnet of the IP address set for the LAN, SFP+, and USB is duplicated, the network connectivity of the unit cannot be guaranteed, so take note of the IP addresses set manually and the IP addresses allocated by the DHCP.
- When connecting to IP addresses that have differing subnets, set so the metric of the interface to be used is the minimum value. For example, when connecting to IP addresses where the domain name has been resolved, set the metric of the interface to be used to the minimum value.
- When multicast transmission is to be used, set the metric of the interface to be used to the minimum value.
- Multicast transmissions other than with the Media over IP function using the SFP+ interface are not possible.
- If the same subnet was set and you cannot access this unit, set an IP address with a different subnet with the EasyIP Setup tool, then revise the settings again from the web page.
- If the metric values are set to the same values for each of the interfaces, the network connectivity of the unit cannot be guaranteed, so take note of the IP addresses set manually and the IP addresses allocated by the DHCP.

### LAN

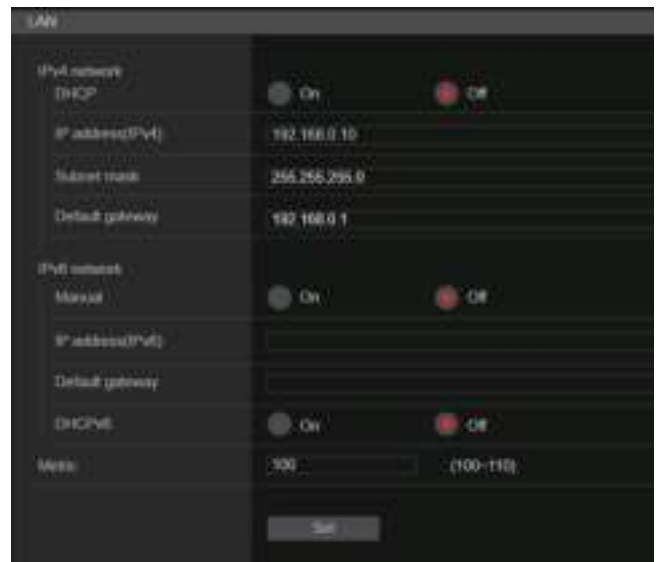

### IPv4 network

#### DHCP [On, Off]

Select the method in which the IP address is configured.

**Factory settings:** Off

#### <NOTE>

- When [DHCP] is set to [On], AW-RP150/AW-RP60's automatic configuration of IP address (AUTO IP) cannot be used.

#### IP address (IPv4)

Input the unit's IP address here when the DHCP function is not going to be used. Input an address that will not duplicate an existing IP address which has been set for a personal computer or another network camera.

**Factory settings:** 192.168.0.10

#### <NOTE>

- Multiple IP addresses cannot be used even when the DHCP function is used. For details on the DHCP server settings, consult your network administrator.

#### Subnet mask

Input the unit's subnet mask here if the DHCP function is not going to be used.

**Factory settings:** 255.255.255.0

#### Default gateway

Input the unit's default gateway if the DHCP function is not going to be used.

**Factory settings:** 192.168.0.1

#### <NOTE>

- Multiple IP addresses cannot be used for the default gateway even when the DHCP function is used. For details on the DHCP server settings, consult your network administrator.

### IPv6 network

#### Manual [On, Off]

Enable or disable manual configuration of the IPv6 address.

On	Enter the IPv6 address manually.
Off	Disable manual entry of the IPv6 address.

**Factory settings:** Off

#### IP address(IPv6)

When [Manual] is set to [On], the IPv6 address must be entered manually.

Be sure to enter an address unique from other devices.

#### <NOTE>

- When connecting to the manually specified IP address through a router, use an IPv6-compatible router, and enable the automatic configuration function for the IPv6 address. Be sure to configure an IPv6 address that includes the prefix information provided by the IPv6-compatible router. For details, refer to the operating instructions for the router.
- Link local address cannot be set.

#### Default gateway

When [Manual] is set to [On] for [IPv6 network], enter the default gateway for the unit's IPv6 network.

**Factory settings:** blank

#### <NOTE>

- It is not possible to set the default gateway when [DHCPv6] is [On].

#### DHCPv6 [On, Off]

Enable or disable use of the IPv6 DHCP function.

Configure the DHCP server so that the same IP address is not configured for a personal computer that does not use the DHCP function and other network cameras. For details on server settings, consult your network administrator.

On	Use the IPv6 DHCP function.
Off	Do not use the IPv6 DHCP function.

**Factory settings:** Off

### Metric [100 to 110]

Set the LAN interface priority for this unit.

Packets are output with priority to the interface with the lower number compared to the value set in [SFP+]/[USB].

**Factory settings:** 100

### ● SFP+



#### <NOTE>

- This cannot be set when the [Basic Config]—[SFP+ Mode] is [12G Output].

### IPv4 network

#### DHCP [On, Off]

Select the method for setting the IP address.

**Factory settings:** Off

#### <NOTE>

- When [DHCP] has been set to [On], it is not possible to use the automatic IP address setting (AUTO IP) from AW-RP150 or AW-RP60.

#### IP address(IPv4)

When not using the DHCP function, enter the unit's IP address.

Enter so that the address does not duplicate the IP addresses of the personal computer or other network cameras.

**Factory settings:** 192.168.0.10

#### <NOTE>

- Even when using the DHCP function, it is not possible to use multiple IP addresses. Consult the network administrator regarding the settings for the DHCP server.

#### Subnet mask

When not using the DHCP function, enter the unit's subnet mask.

**Factory settings:** 255.255.255.0

#### Default gateway

When not using the DHCP function, enter the unit's default gateway.

**Factory settings:** 192.168.0.1

#### <NOTE>

- Even when using the DHCP function, it is not possible to use multiple IP addresses with the default gateway. Consult the network administrator regarding the settings for the DHCP server.

### Metric [100 to 110]

Set the SFP+ interface priority for this unit.

Packets are output with priority to the interface with the lower number compared to the value set in [LAN]/[USB].

**Factory settings:** 103

### ● USB

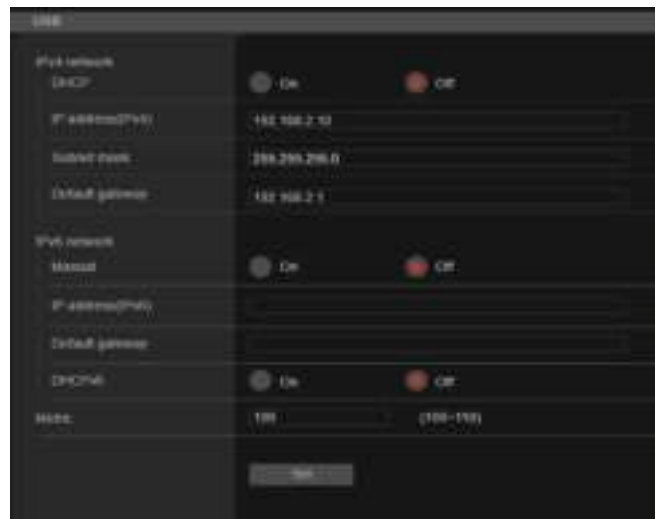

### IPv4 network

#### DHCP [On]

Select the method for setting the IP address.

**Factory settings:** Off

#### <NOTE>

- When [DHCP] has been set to [On], it is not possible to use the automatic IP address setting (AUTO IP) from AW-RP150 or AW-RP60.

## Web screen configurations (continued)

### IP address(IPv4)

When not using the DHCP function, enter the unit's IP address. Enter so that the address does not duplicate the IP addresses of the personal computer or other network cameras.

**Factory settings:** 192.168.3.10

#### <NOTE>

- Even when using the DHCP function, it is not possible to use multiple IP addresses. Consult the network administrator regarding the settings for the DHCP server.

### Subnet mask

When not using the DHCP function, enter the unit's subnet mask.

**Factory settings:** 255.255.255.0

### Default gateway

When not using the DHCP function, enter the unit's default gateway.

**Factory settings:** 192.168.3.1

#### <NOTE>

- Even when using the DHCP function, it is not possible to use multiple IP addresses with the default gateway. Consult the network administrator regarding the settings for the DHCP server.

## IPv6 network

### Manual [On, Off]

Enable or disable manual configuration of the IPv6 address.

On	Enter the IPv6 address manually.
Off	Disable manual entry of the IPv6 address.

**Factory settings:** Off

### IP address(IPv6)

When [Manual] is set to [On], the IPv6 address must be entered manually.

Be sure to enter an address unique from other devices.

#### <NOTE>

- When connecting to the manually specified IP address through a router, use an IPv6-compatible router, and enable the automatic configuration function for the IPv6 address. Be sure to configure an IPv6 address that includes the prefix information provided by the IPv6-compatible router. For details, refer to the operating instructions for the router.
- Link local address cannot be set.

### Default gateway

When [Manual] is set to [On] for [IPv6 network], enter the default gateway for the unit's IPv6 network.

**Factory settings:** blank

#### <NOTE>

- It is not possible to set the default gateway when [DHCPv6] is [On].

### DHCPv6 [On, Off]

Enable or disable use of the IPv6 DHCP function.

Configure the DHCP server so that the same IP address is not configured for a personal computer that does not use the DHCP function and other network cameras. For details on server settings, consult your network administrator.

On	Use the IPv6 DHCP function.
Off	Do not use the IPv6 DHCP function.

**Factory settings:** Off

## Metric [100 to 110]

Set the USB interface priority for this unit.

Packets are output with priority to the interface with the lower number compared to the value set in [LAN]/[SFP+].

**Factory settings:** 109

## ● DNS

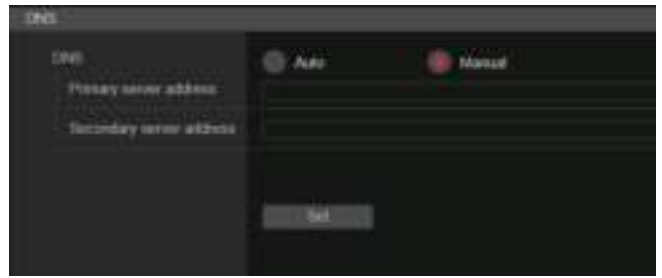

### DNS [Auto, Manual]

Select the method for setting the DNS server.

Consult the system administrator regarding the settings.

**Factory settings:** Manual

### Primary server address

### Secondary server address

Enter the IPv4/IPv6 address for the DNS server.

Consult the system administrator regarding the IPv4/IPv6 address for the DNS server.

## ● Domain

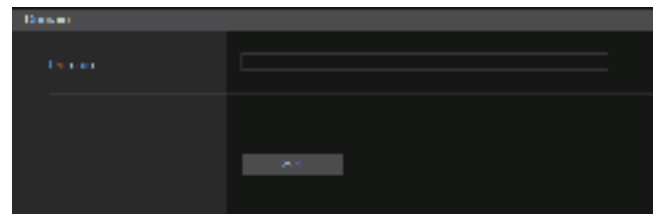

### Domain

Set the domain that this unit belongs to.

## ● Common (to IPv6/IPv4)

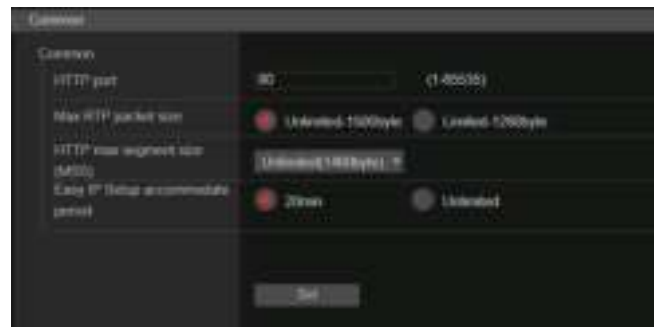

### HTTP port [1 to 65535]

Port numbers are allocated separately.

The following port numbers are used by the unit so they cannot be used.

20, 21, 23, 25, 42, 53, 67, 68, 69, 110, 123, 161, 162, 443, 546, 547, 554, 995, 5960 to 5985, 7960 to 8060, 10669, 10670, 11900, 59000 to 61000

**Factory settings:** 80

### Max RTP packet size

#### [Unlimited-1500byte, Limited-1280byte]

Specify whether to limit the size of RTP packets sent from the camera when using RTP to view camera images.

Unlimited-1500byte	Unlimited (1500 byte)
Limited-1280byte	Limited (1280 byte)

**Factory settings:** Unlimited-1500byte

Normally, it is recommended that the [Unlimited-1500byte] setting be used.

Select [Limited-1280byte] when the packet size of the used communication line is limited. For details on the maximum packet size of communication lines, consult your network administrator.

### HTTP max segment size (MSS) [Unlimited(1460byte), Limited(1280byte), Limited(1024byte)]

Select whether to limit the maximum segment size (MSS) transmitted by a camera when viewing camera images using HTTP.

Unlimited(1460byte)	Unlimited (1460 byte)
Limited(1280byte)	Limited (1280 byte)
Limited(1024byte)	Limited (1024 byte)

**Factory settings:** Unlimited(1460byte)

Normally, it is recommended that the default setting be used.

Select [Limited(1024byte)]/[Limited(1280byte)] when the maximum segment size (MSS) of the used communication line is limited. For details on the maximum segment size (MSS) of communication lines, consult your network administrator.

### Easy IP Setup accommodate period [20min, Unlimited]

Sets the time allowed for network setting operations from EasyIP Setup Tool Plus. You can set either [20min] from the time this unit is started or [Unlimited].

20min	Allows camera setting operations on the EasyIP Setup Tool Plus for just 20 minutes after start up of this unit.
Unlimited	Allows camera setting operations on the EasyIP Setup Tool Plus at any time.

**Factory settings:** 20min

#### <NOTE>

- Camera display on the EasyIP Setup Tool Plus is enabled all the time, and the camera screen can be opened.
- For details on the address settings of each server, consult your network administrator.
- The port forwarding function converts a global IP address to a private IP address, and includes "static IP masquerade" and "network address translation (NAT)". This function is set to the router.
- To access the camera via the Internet after connecting it to a router, it will be necessary to set an individual HTTP port No. for each network camera and to convert the address using the router's port forwarding function. For details, refer to the operating instructions for the router.

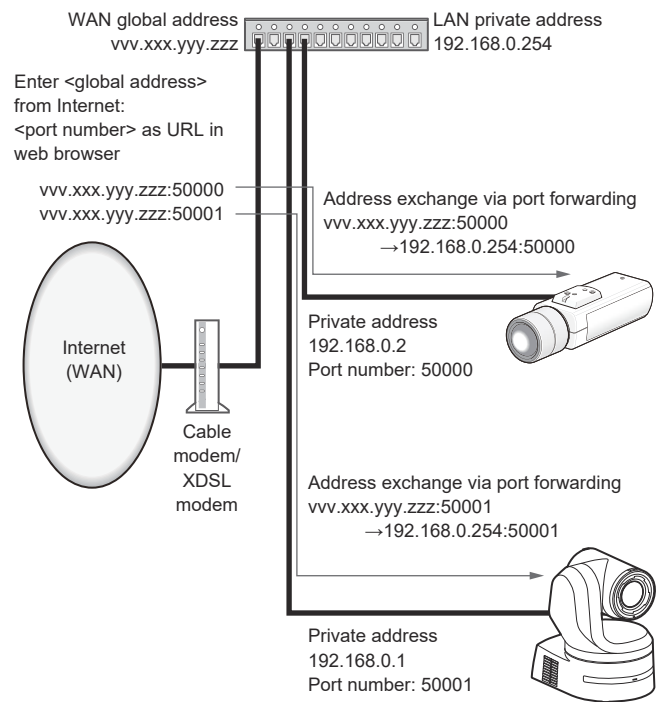

### Advanced network setting screen [Advanced]

Click the [Advanced] in the network setup screen [Network].

Settings relating to the NTP and HTTPS functions are performed here. Click the links to each item to move to the respective setting page.

#### ● NTP

Settings relating to the NTP server address and port No. are performed here.

The setting is confirmed with the [Set] button.

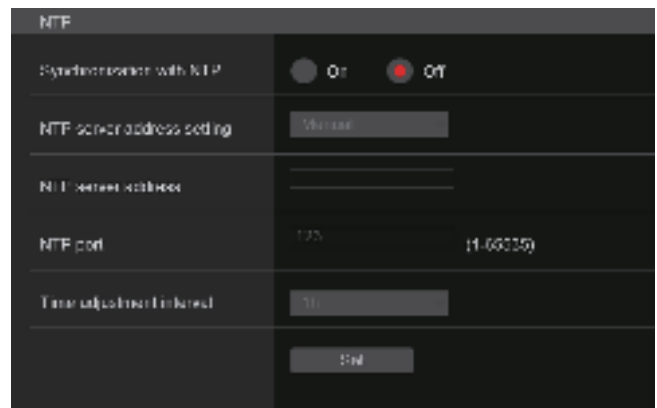

### Synchronization with NTP [On, Off]

On	The time adjusted automatically through synchronization with the NTP server will be used as this unit's standard time.
Off	The time set in Date & time screen [Date&Time] will be used as this unit's standard time.

**Factory settings:** Off

## Web screen configurations (continued)

### NTP server address setting [Auto, Manual]

Select the method to acquire the NTP server address.

Auto	Acquires the NTP server address from the DHCP server.
Manual	Sets the address by inputting the NTP server address in [NTP server address].

**Factory settings:** Manual

#### <NOTE>

- To acquire the NTP server address from the DHCP server, [DHCP] or [DHCPv6] must be set to [On] in the [Network] of the network setup screen [Network]. (→ page 169)

### NTP server address

When [Manual] is selected in the [NTP server address setting], input the IP address or host name of the NTP server.

Maximum number of characters	1 to 128 characters
Characters that can be entered	Alphanumeric characters, symbols : . _ -

**Factory settings:** blank

#### <NOTE>

- To input the [NTP server address] host name, the [DNS] setting must be selected on the [Network] of the network setup screen [Network]. (→ page 169)
- This does not work when link local address is set in [NTP server address].

### NTP port [1 to 65535]

Input the port No. of the NTP server.

The following port numbers are used by the unit so they cannot be used.

20, 21, 23, 25, 42, 53, 67, 68, 69, 80, 110, 161, 162, 443, 546, 547, 554, 995, 5960 to 5985, 7960 to 8060, 10669, 10670, 11900, 59000 to 61000

**Factory settings:** 123

### Time adjustment interval [1h to 24h]

Selects the interval (1 to 24 hours in 1-hour increments) for acquiring the time from the NTP server.

**Factory settings:** 1h

### ● HTTPS

Using the HTTPS function enables access to the camera to be encrypted and communication safety to be improved.

The setting is confirmed with the [Set] button.

See page 179 for details on the HTTPS setup method.



### CRT key generate

A CRT key (SSL encryption key) is generated by HTTPS.

To generate a CRT key, click the [Execute] button to display the [CRT key generate] dialog.

For details, refer to "Generating a CRT key (SSL encryption key)" (→ page 180).

### Self-signed Certificate - Generate

A self-signed security certificate is generated by HTTPS. (Self-signed Certificate)

To generate a self-signed certificate (security certificate), click the [Execute] button to display the [Self-signed Certificate - Generate] dialog and perform the operation.

For details, refer to "Generating a self-signed certificate (security certificate)" (→ page 180).

### Self-signed Certificate - Information

This displays information relating to the self-signed certificate (security certificate).

When the [Confirm] button is clicked, the registered content of the generated self-signed certificate (security certificate) is displayed in the [Self-signed Certificate - Confirm] dialog.

Click the [Delete] button to delete the generated self-signed certificate (security certificate).

### CA Certificate - Generate Certificate Signing Request

When using a security certificate issued by the Certificate Authority (CA) as a security certificate for HTTPS, a Certificate Signing Request (CSR) is generated for application to the Certificate Authority (CA). To generate a Certificate Signing Request (CSR), click the [Execute] button to display the [CA Certificate - Generate Certificate Signing Request] dialog and perform the operation. For details, refer to "Generating a Certificate Signing Request (CSR)" (→ page 181).

### CA Certificate - CA Certificate install

This displays information relating to server certificates (security certificates) issued by the Certificate Authority (CA), which are to be or are already installed. In the [File Open] dialog, which is displayed by clicking the [Select] button, select the file of the server certificate (security certificate) issued by the Certificate Authority (CA) and click the [Execute] button to install the server certificate (security certificate). If the server certificate (security certificate) is installed, its file name will be displayed. For details, refer to "Installing a Server Certificate" (→ page 182).

### CA Certificate - Information

This displays information relating to the server certificate (security certificate). When the [Confirm] button is clicked, the registered content of the installed server certificate (security certificate) is displayed in the [Server Certificate - Confirm] dialog. If the server certificate (security certificate) is not installed, the content of the generated Certificate Signing Request (CSR) is displayed. Click the [Delete] button to delete the installed server certificate (security certificate).

#### <NOTE>

- To delete an enabled server certificate (security certificate), confirm that there is a backup to the said certificate in your personal computer or recording media. A server certificate (security certificate) will be needed to reinstall it.

### Connection [HTTP, HTTPS]

This sets the method to connect to the unit.

HTTP	Only HTTP connection is possible.
HTTPS	Only HTTPS connection is possible.

#### Factory settings: HTTP

For details, refer to "Setting the Connection Method" (→ page 183).

#### <NOTE>

- When using an HTTPS connection, network connection with the AW-RP120, AW-RP50, and AK-HRP200 will be disabled.

### HTTPS port [1 to 65535]

This sets the Port No. to be used with HTTPS.

The following port numbers are used by the unit so they cannot be used.

20, 21, 23, 25, 42, 53, 67, 68, 69, 80, 110, 123, 161, 162, 546, 547, 554, 995, 5960 to 5985, 7960 to 8060, 10669, 10670, 11900, 59000 to 61000

Factory settings: 443

#### <NOTE>

- This unit will restart if the connection method is changed.
- When using a self-signed certificate:
  - A warning screen is displayed when accessing the camera by HTTPS for the first time. Install the self-signed certificate (security certificate) in your personal computer in accordance with the screen instructions. (→ page 184)
- When using a server certificate:
  - Install the Certificate Authority (CA) root certificate or intermediate certificate in your web browser in advance. Follow the Certificate Authority (CA) procedures to acquire and install root certificates and intermediate certificates.
- When accessing the camera by HTTPS, the image display speed and frame rate of the moving image may reduce.
- When accessing the camera by HTTPS, it may take some time for the images to be displayed.
- When accessing the camera by HTTPS, images may be disturbed and sound may be interrupted.
- The maximum number of cameras that can be connected simultaneously depends on the maximum image size and distribution format.

### HTTPS mode [TLS1.0/1.1/1.2/1.3, TLS1.2, TLS1.3]

This sets the encryption protocol when accessing the camera with HTTPS.

TLS1.0/1.1/1.2/1.3	Permits connection with TLS1.0/1.1/1.2/1.3 when HTTPS is enabled.
TLS1.2	Permits connection with TLS1.2 when HTTPS is enabled.
TLS1.3	Permits connection with TLS1.3 when HTTPS is enabled.

Factory settings: TLS1.2

## Web screen configurations (continued)

### ● RTSP

This performs settings related to the RTSP function. The RTSP function sets the RTSP transmission port and RTSP request URL used during IP image transmission.

The setting is confirmed with the [Set] button.

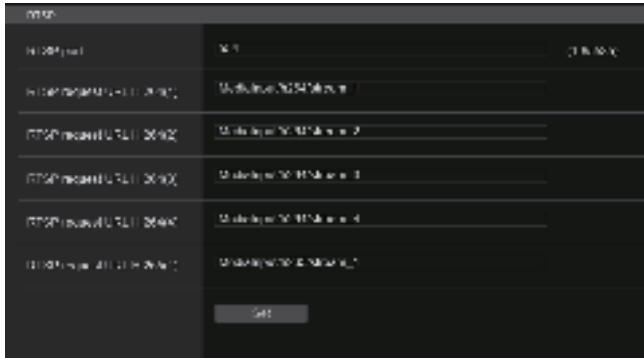

#### RTSP port [1 to 65535]

Sets the RTSP reception port no.

The following port numbers are used by the unit so they cannot be used.

20, 21, 23, 25, 42, 53, 67, 68, 69, 80, 110, 123, 161, 162, 443, 546, 547, 995, 5960 to 5985, 7960 to 8060, 10669, 10670, 11900, 59000 to 61000

**Factory settings:** 554

#### RTSP request URL

Sets up the URL for RTSP when making IP image transmission demands to this unit.

RTSP request URL H.264(1)	RTSP URL for H.264(1) image transmission
RTSP request URL H.264(2)	RTSP URL for H.264(2) image transmission
RTSP request URL H.264(3)	RTSP URL for H.264(3) image transmission
RTSP request URL H.265(1)	RTSP URL for H.265(1) image transmission
RTSP request URL H.265(2)	RTSP URL for H.265(2) image transmission

#### Factory settings:

RTSP request URL H.264(1)	MediaInput/h264/stream_1
RTSP request URL H.264(2)	MediaInput/h264/stream_2
RTSP request URL H.264(3)	MediaInput/h264/stream_3
RTSP request URL H.265(1)	MediaInput/h265/stream_1
RTSP request URL H.265(2)	MediaInput/h265/stream_2

- Up to 255 characters can be entered.
- The following characters can be displayed.

Numeric characters	0123456789
Alphabetical characters (upper and lower cases)	ABCDEFGHIJKLMNOPQRSTUVWXYZ abcdefghijklmnopqrstuvwxyz
Symbols	/ - _

#### <NOTE>

- RTSP request URL cannot have the same URL.

### ● SNMP

Make SNMP functionality related settings. You can check the status of the unit by using the SNMP manager to connect.

The setting is confirmed with the [Set] button.

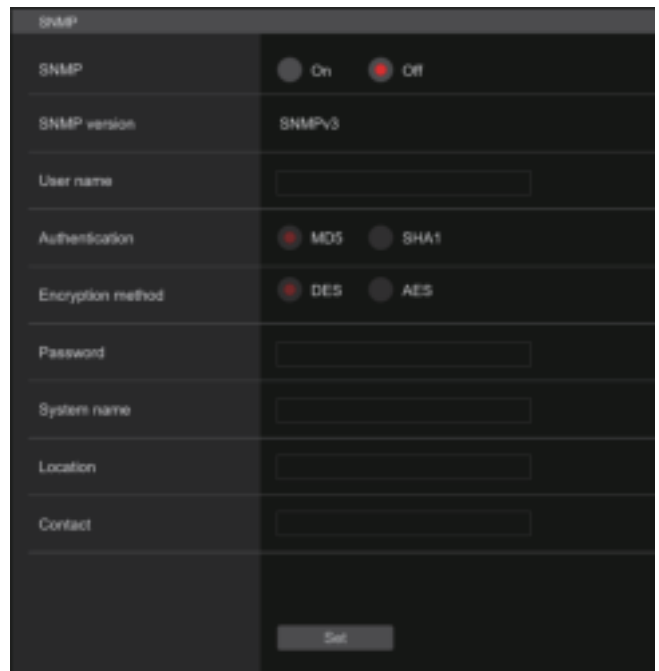

#### SNMP [On, Off]

Sets whether to use the SNMP function.

**Factory settings:** Off

#### User name

Sets the user name used for user authentication.

You need to specify the same user name that you set here in the SNMPv3 manager.

Maximum number of characters	0 to 32 characters
Characters that cannot be entered	Double-byte

#### Authentication

Sets the algorithm used for user authentication.

MD5	MD5 is used as the algorithm for user authentication.
SHA1	SHA1 is used as the algorithm for user authentication.

**Factory settings:** SHA1

#### Encryption method

Sets the encryption method used for communications.

DES	DES is used as the encrypted communication method for SNMPv3.
AES	AES is used as the encrypted communication method for SNMPv3.

**Factory settings:** AES

#### Password

Sets the password used for user authentication.

You need to specify the same password that you specified here in the SNMPv3 manager.

Maximum number of characters	When [Authentication] is set to [MD5]: 8 to 16 characters When [Authentication] is set to [SHA1]: 8 to 20 characters
Characters that cannot be entered	Double-byte



## Web screen configurations (continued)

### System name

Enter the device name used to manage this unit using SNMP functionality.

Maximum number of characters	0 to 32 characters
Characters that cannot be entered	Double-byte

### Location

Sets the location where this unit has been installed.

Maximum number of characters	0 to 32 characters
Characters that cannot be entered	Double-byte

### Contact

Enter the email address or phone number of the administrator.

Maximum number of characters	0 to 255 characters
Characters that cannot be entered	Double-byte

### ● TSL5.0

Make settings related to TSL protocol version 5.0. Set the information required to control the tallies of this unit from a device that supports the TSL5.0 protocol with the TSL5.0 function. The setting is confirmed with the [Set] button.

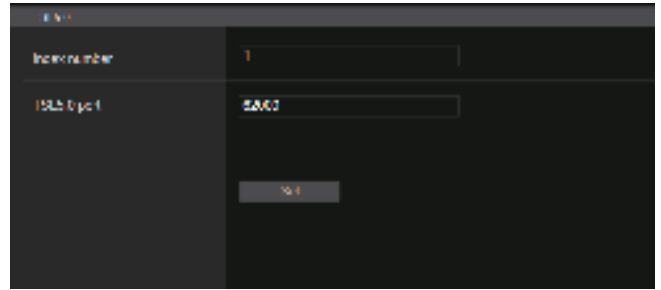

### Index number [1 to 65534]

By matching the INDEX set on the TSL5.0 control device and the Index number of this unit, you can control the tallies of this unit individually.

**Factory settings:** 1

### TSL5.0 Port [1 to 65535]

Sets the port number that will receive controls via the TSL 5.0 protocol.

**Factory settings:** 62000

### ● Referrer check

By enabling Referrer check, you can confirm that the device requesting access to the camera is legitimate.

Access is refused if it is determined that the device attempting access is unauthorized.

Depending on the environment in which the unit is being used, it may not be possible to access the unit when Referrer check is enabled.

If this occurs, you can access the unit by disabling Referrer check, but you will no longer be able to determine if the device attempting access is unauthorized.

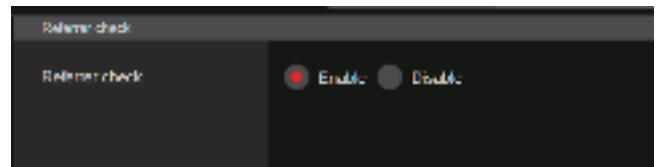

Enable	The Referrer check function is used.
Disable	The Referrer check function is not used.

**Factory settings:** Enable



### ● mDNS

By setting an [mDNS] [Host name], it is possible to access this unit via `http://Host name.local`.

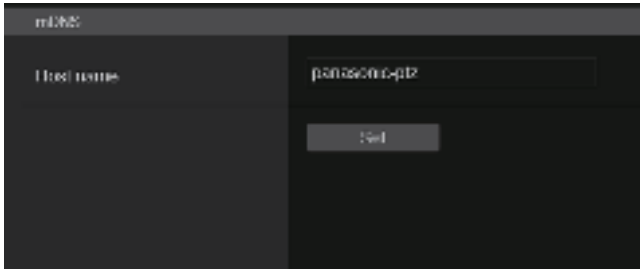

Maximum number of characters	63 characters
Characters that can be entered	Alphanumeric characters, symbols : -

**Factory settings:** panasonic-ptz

#### <NOTE>

- Proper operation cannot be guaranteed if there is another camera with the same settings in the same network.

### ● 802.1X

Makes settings for the IEEE 802.1X client.  
The setting is confirmed with the [Set] button.

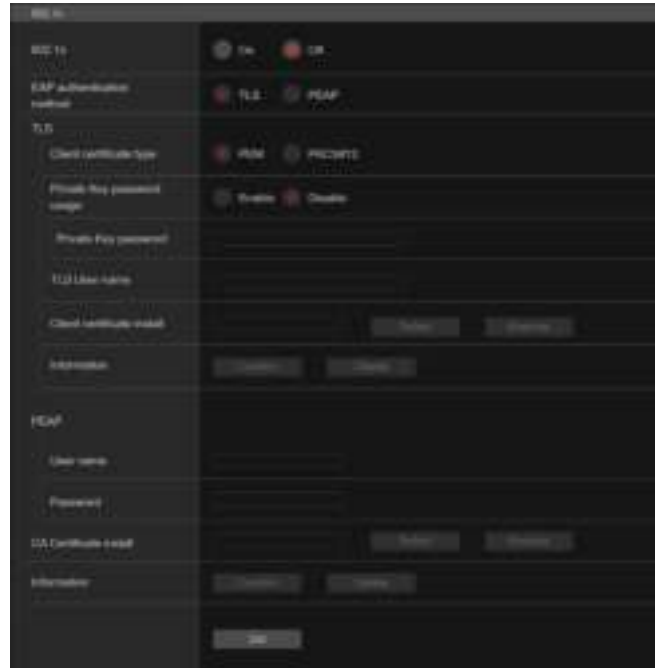

#### <NOTE>

- You will require 802.1X knowledge in order to complete the settings. Consult the network administrator for details.
- It is necessary to make settings for an authentication server and Authenticator separately when building a system that uses this function. Consult the network administrator for details.
- In a system configuration where 802.1X is enabled, it is not possible to control the camera from AW-RP150 or AW-RP60.
- Before setting, go to either the [Date&Time] settings screen or the [NTP] settings screen to set the time for this unit. Proper operation may not be possible if the time has not be set correctly for the unit.
- Before setting, in the [Date&Time] settings screen, set [Memory] to [Enable].

#### 802.1X [On, Off]

Sets whether to use the 802.1X function.

**Factory settings:** Off

#### EAP authentication method [TLS, PEAP]

Makes settings for the authentication method used for the 802.1X function.

This unit supports authentication methods using TLS or PEAP.

**Factory settings:** TLS

#### <NOTE>

- Proper operation may not be possible if it does not match the authentication method permitted by the authentication server.

#### TLS

Makes settings for when the TLS authentication method is used.

## Web screen configurations (continued)

### Client certificate type [PEM, PKCS#12]

Makes settings for the client certificate method used with TLS authentication.

This unit supports the PEM and PKCS#12 methods.

#### <NOTE>

- When a private key is to be used, the private key information must be included in the client certificate.  
Set [Private Key password usage] to [Enable] and set the correct password.
- When installing a client certificate with the PKCS#12 method, it is necessary to set [Private Key password usage] to [Enable] and to set the correct password.
- If the PKCS#12 method is selected, the PKCS#12 password and the [Private Key password] need to match.

### Private Key password usage [Enable, Disable]

Sets whether to use a private key in the client certificate.

Enable	Select when a private key is to be used.
Disable	Select when a private key is not to be used.

#### <NOTE>

- If [Enable] is selected, the correct value needs to be set for [Private Key password].

### Private Key password

Makes settings for the password set in the private key.

#### <NOTE>

- When installing a PKCS#12 method client certificate, enter the same password as the one set for PKCS#12.

### TLS User name

Sets a user name permitted by TLS authentication.

#### <NOTE>

- Consult the network administrator regarding valid user names.

### Client certificate install

Installs the client certificate.

#### <NOTE>

- The client certificate installed must be the correct one issued by the certificate authority.
- Before installing the certificate, check that the settings for [Client certificate type], [Private Key password usage], and [Private Key password] have been completed.  
The certificate may not be installed correctly if the above settings have not been completed.

## PEAP

Makes settings for when the PEAP authentication method is used.

### User name

Sets a user name permitted by PEAP authentication.

#### <NOTE>

- Consult the network administrator regarding valid user names.

### Password

Sets the password attached to the User name in PEAP authentication.

#### <NOTE>

- Consult the network administrator regarding valid passwords.

## CA Certificate install

Installs the CA certificate used in IEEE 802.1X authentication.

#### <NOTE>

- The CA certificate installed must be one issued by the correct certificate authority.

## ● Easy IP Setup Tool Plus

Makes settings related to Easy IP Setup Tool Plus.

The setting is confirmed with the [Set] button.

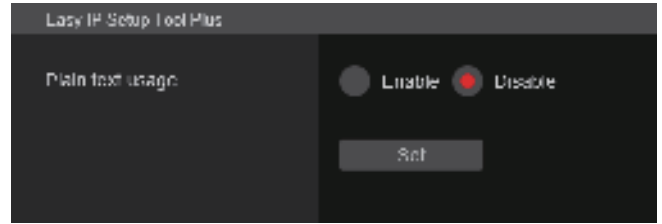

### Plain text usage [Enable, Disable]

Sets whether to encrypt the communications with Easy IP Setup Tool Plus.

**Factory settings:** Disable

**■ HTTPS settings [HTTPS]**

This encrypts access to the camera and sets HTTPS to improve communication safety. Setting HTTPS is performed by following the procedures below. The setting is confirmed with the [Set] button.

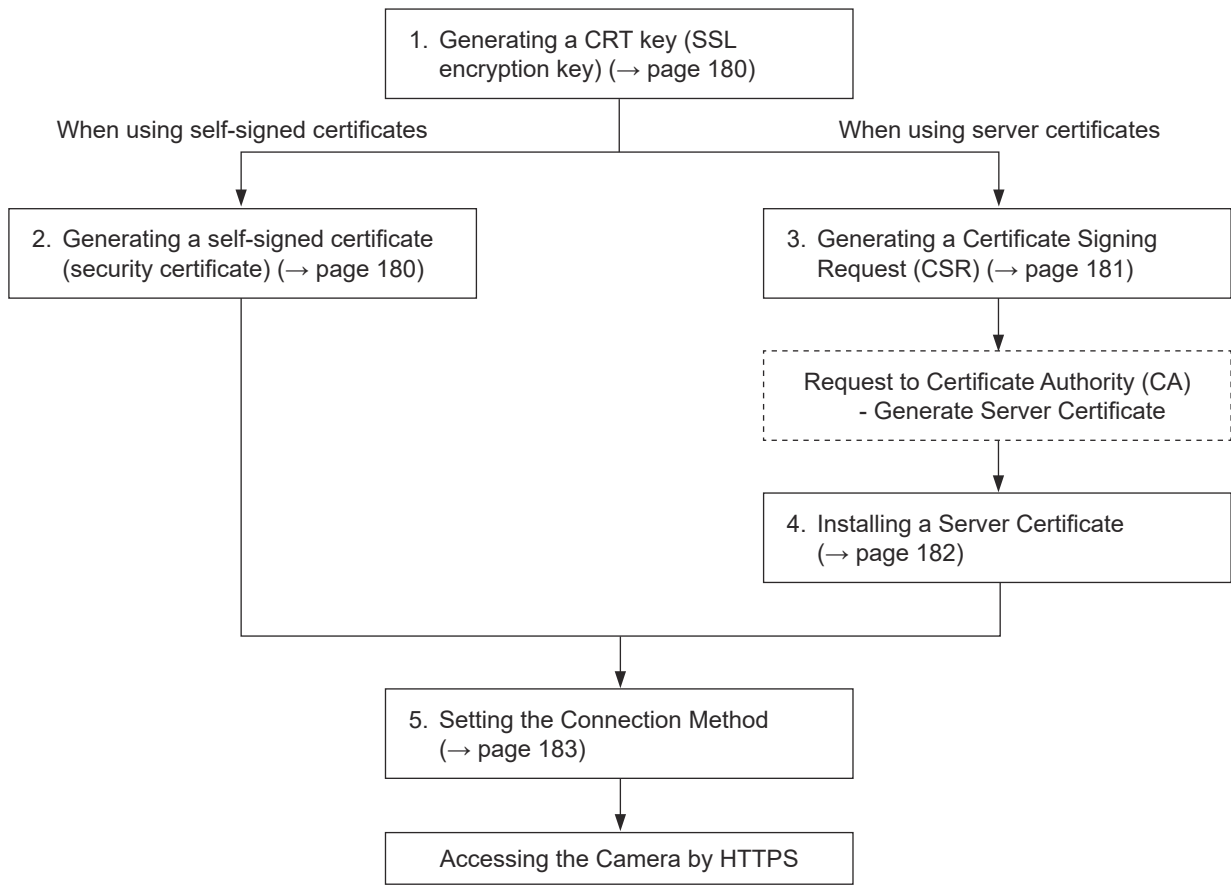
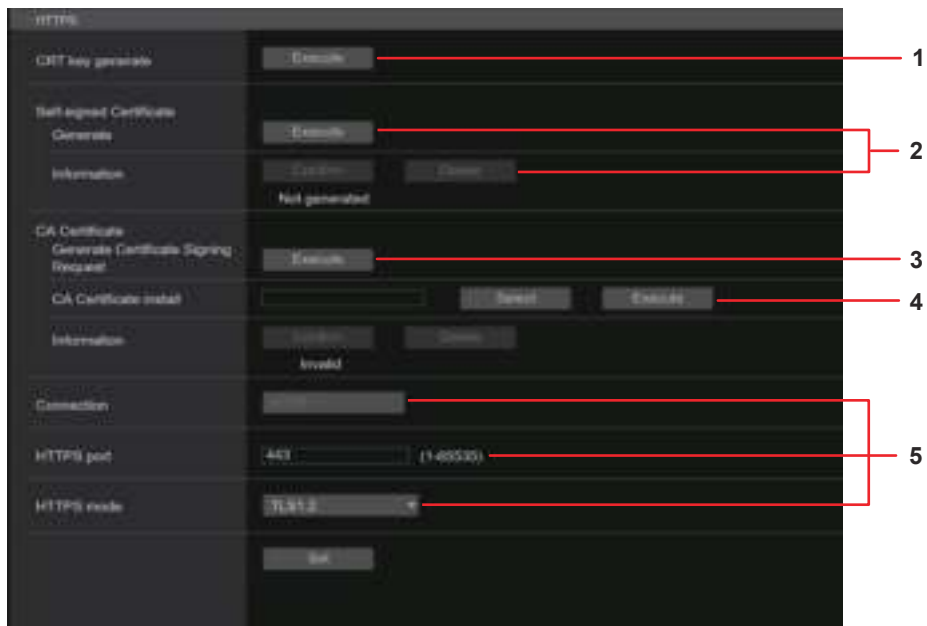

**<NOTE>**

- When using a server certificate, the process from applying to the Certificate Authority (CA) to issuing a server certificate must be performed between customers and the Certificate Authority (CA).
- Use either a self-signed certificate or server certificate. When simultaneously generating a self-signed certificate and installing a server certificate, this unit will prioritize the server certificate.

**■ Generating a CRT key (SSL encryption key)**  
**[CRT key generate]**

<NOTE>

- A CRT key cannot be generated when self-signed certificates and server certificates are enabled.
- The size of the key that can be used by the Certificate Authority (CA) differs when using a server certificate. Confirm in advance the size of the key that can be used.
- Generating a CRT key takes about 1 minute for 1024 bit and about 2 minutes for 2048 bit. Do not operate the web browser until CRT key generation is complete. Image display and communication speed may reduce while generating a CRT key.

**1. Click the [Execute] button in [CRT key generate].**

The [Current CRT key] dialog is displayed.

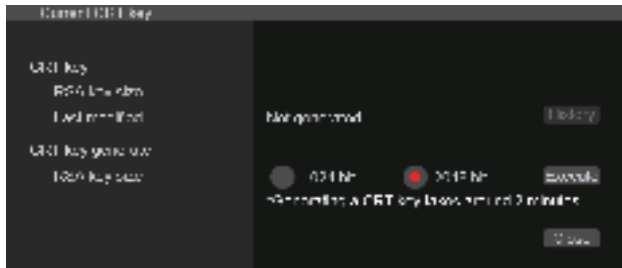

**2. The size of the generated CRT key is selected from [1024bit]/[2048bit] in [CRT key generate] – [RSA key size].**

<NOTE>

- When using a server certificate, the RSA key size must be in accordance with the demands of the Certificate Authority (CA) which will be applied to.

**3. Click the [Execute] button.**

CRT key generation starts.

The length of the generated CRT key and the date/time that generation completed are displayed in [Current CRT key] when CRT key generation finishes.

<NOTE>

- Perform procedures 1 to 3 to change (update) the generated CRT key. Because the CRT key, self-signed certificate and server certificate are enabled as a set, it will be necessary to once again generate a self-signed certificate or apply for a server certificate when the CRT key is changed.
  - When the CRT key is changed, previous CRT keys are historically managed one at a time. Clicking the [History] button in the [CRT key] of the [Current CRT key] dialog displays the [Previous CRT key] dialog, allowing confirmation of the key size and the date and time generation was completed.
- Clicking the [Apply] button in [Previous CRT key] allows the previous CRT key to be switched to the current CRT key.

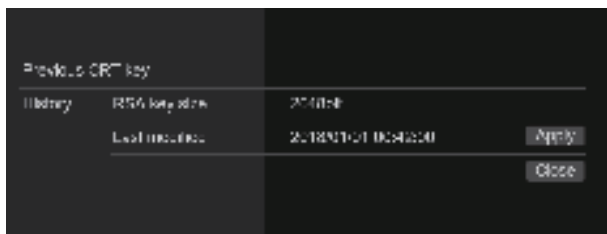

**■ Generating a self-signed certificate (security certificate)**

**[Self-signed Certificate - Generate]**

<NOTE>

- A self-signed certificate cannot be generated when a CRT key has not been generated.

**1. Click the [Execute] button in [Self-signed Certificate] - [Generate].**

[Self-signed Certificate - Generate] is displayed.

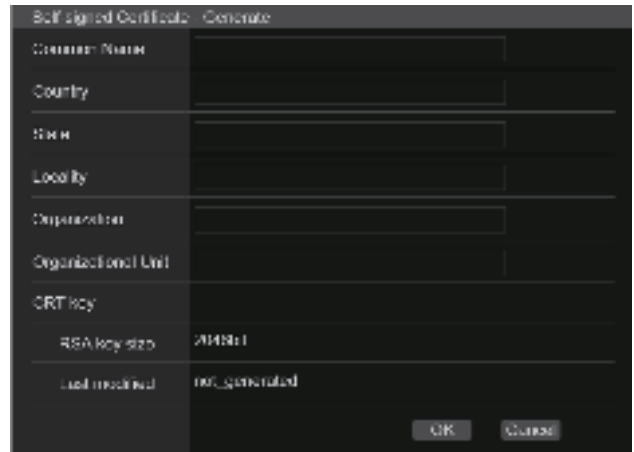

**2. Input information relating to the certificate to be generated.**

Items to be entered are as follows.

Item	Description	Maximum number of characters
Common Name	Inputs the camera address or host name.	64 characters
Country	Inputs the country code. (May be omitted)	2 characters: country code
State	Inputs the name of the state. (May be omitted)	128 characters
Locality	Inputs the name of the city. (May be omitted)	128 characters
Organization	Inputs the name of the organization. (May be omitted)	64 characters
Organizational Unit	Inputs the name of the organizational unit. (May be omitted)	64 characters
CRT key	Displays the size of the current CRT key and the date and time generation was completed.	

<NOTE>

- Characters that can be input for [Common Name], [Country], [State], [Locality], [Organization], [Organizational Unit] are 0 to 9, A to Z, a to z, and the following symbols: -, \_, + / ( ).
- When connecting the camera to the Internet, set the address or host name to be accessed from the Internet in [Common Name]. In this case, when accessing the camera locally, a security warning screen is displayed every time the camera is accessed even when a security certificate is installed.
- When inputting the IPv6 address in [Common Name], surround the address with [ ].  
 e.g. [2001:db8::10]

**3. Click the [OK] button after inputting the address.**

A self-signed certificate is generated.

<NOTE>

- Information relating to the generated self-signed certificate is displayed in [Self-signed Certificate] - [Information]. The following is displayed depending on the status of the self-signed certificate (security certificate).

Displayed content	Description
Not generated	When the self-signed certificate is not generated
Invalid (Reason: CA Certificate installed)	When the self-signed certificate is already generated and the server certificate is already installed <ul style="list-style-type: none"> <li>The server certificate is enabled in this case.</li> </ul>
[Common Name] of self-signed certificate	When the self-signed certificate is already generated and enabled

- When the [Confirm] button is clicked, the registered content of the generated self-signed certificate (security certificate) is displayed in the [Self-signed Certificate - Confirm] dialog.

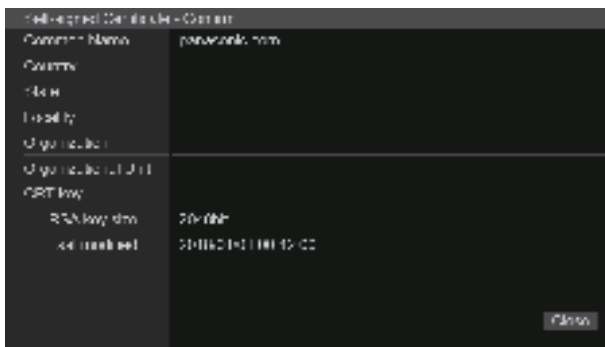

- Click the [Delete] button to delete the generated self-signed certificate (security certificate).
- When [HTTPS] is selected in [Connection], the self-signed certificate (security certificate) cannot be deleted.

**■ Generating a Certificate Signing Request (CSR) [CA Certificate - Generate Certificate Signing Request]**

<NOTE>

- A certificate signing request (CSR) cannot be generated if a CRT key has not been generated.
- To generate a certificate signing request (CSR), perform the following settings in advance in the web browser Internet options. Perform the following settings in the [Security] tab (accessed from [Tools] in the menu bar - [Internet Options] - [Security]).
  - Register the camera as a "Trusted Site".
- In [Level Customize], go to [File Download] from [Download] and set to [Enable].
- In [Level Customize], go to [Automatically Display Dialog when Downloading File] from [Download] and set to [Enable].

**1. Click the [Execute] button in [CA Certificate - Generate Certificate Signing Request].**

The [CA Certificate - Generate Certificate Signing Request] dialog is displayed.

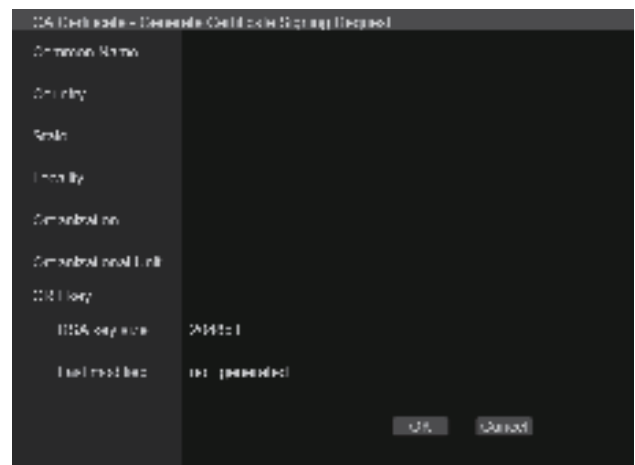

**2. Input information relating to the certificate to be generated.**

Items to be entered are as follows.

Item	Description	Maximum number of characters
Common Name	Inputs the camera address or host name.	64 characters
Country	Inputs the country code.	2 characters: country code
State	Inputs the name of the state.	128 characters
Locality	Inputs the name of the city.	128 characters
Organization	Inputs the name of the organization.	64 characters
Organizational Unit	Inputs the name of the organizational unit.	64 characters
CRT key	Displays the size of the current CRT key and the date and time generation was completed.	

<NOTE>

- When using a server certificate, the information to be input must be in accordance with the demands of the Certificate Authority (CA), which will be applied to.
- Characters that can be input for [Common Name], [Country], [State], [Locality], [Organization], [Organizational Unit] are 0 to 9, A to Z, a to z, and the following symbols: -, \_ , + / ( ).

### 3. Click the [OK] button after inputting the address.

The [Save As] dialog is displayed.

### 4. In the [Save As] dialog, assign a file name to the Certificate Signing Request (CSR) and save it in personal computer.

Apply to the Certificate Authority (CA) using the saved Certificate Signing Request (CSR).

#### <NOTE>

- A server certificate is issued for both the generated Certificate Signing Request (CSR) and CRT key. The issued server certificate can no longer be used when generating/updating the CRT key after applying to the Certificate Authority (CA).
- The Certificate Signing Request (CSR) generated by this unit is in a PEM format.

## ■ Installing a Server Certificate

### [CA Certificate - CA Certificate install]

#### <NOTE>

- A server certificate (security certificate) cannot be installed if a Certificate Signing Request (CSR) has not been generated.
- The server certificate must have been issued by the Certificate Authority (CA) in order to install it.

### 1. Click the [Select] button in [CA Certificate - CA Certificate install].

The [Open File] dialog is displayed.

### 2. Select the server certificate file and click [Open]. Then click the [Execute] button.

The server certificate is installed.

#### <NOTE>

- The name of the host registered to the installed server certificate is displayed in [CA Certificate] - [Information]. The following is also displayed depending on the status of the server certificate.

Displayed content	Description
Invalid	When the server certificate is not installed
[Common Name] of server certificate	When the server certificate is already installed and enabled
Expired	When the effective period of the server certificate has expired

- When the [Confirm] button is clicked, the content of the installed server certificate (security certificate) is displayed in the [CA Certificate - Confirm] dialog. (An asterisk is displayed in the [Organizational Unit] field only.)



- Click the [Delete] button to delete the installed server certificate (security certificate).
- When [HTTPS] is selected in [Connection], the server certificate (security certificate) cannot be deleted.
- Perform STEP 1 to STEP 2 to update a server certificate.
- To delete an enabled server certificate (security certificate), confirm that there is a backup to the said certificate in your personal computer or recording media. A server certificate (security certificate) will be needed to reinstall it.
- The HTTPS function can no longer be used when the effective period of the server certificate has expired. In such a case, the connection method is changed to HTTP when the unit is restarted. Update the server certificate before its effective period expires.
- The effective period of the server certificate can be confirmed by double-clicking the server certificate file issued by the Certificate Authority (CA).

### ■ Setting the Connection Method [Connection]

#### 1. Set the method to access the camera in [Connection].

HTTP: Only HTTP connection is possible.

HTTPS: Only HTTPS connection is possible.

##### <NOTE>

- When using an HTTPS connection, network connection with the AW-RP120, AW-RP50, and AK-HRP200 will be disabled.

#### 2. Set the Port No. to be used with HTTPS in [HTTPS port].

Port No. that can be selected: 1 to 65535

The following port numbers are used by the unit so they cannot be used.

20, 21, 23, 25, 42, 53, 67, 68, 69, 80, 110, 123, 161, 162, 443, 546, 547, 554, 995, 5960 to 5985, 7960 to 8060, 10669, 10670, 11900, 59000 to 61000

**Factory settings:** 443

#### 3. Set the encryption protocol used with HTTPS in [HTTPS mode].

TLS1.0/1.1/1.2: Connection with TLS1.0/1.1/1.2 is possible.

TLS1.2: Connection with TLS1.2 is possible.

#### 4. Click the [Set] button.

The camera restarts and access to the camera via HTTPS is enabled.

##### <NOTE>

- This unit will restart if the connection method is changed.
- **Using a self-signed certificate**  
A warning screen is displayed when accessing the camera by HTTPS for the first time. Install the self-signed certificate (security certificate) in your personal computer in accordance with the screen instructions. (→ page 184)
- **Using a server certificate**  
Install the Certificate Authority (CA) root certificate or intermediate certificate in your web browser in advance. Follow the Certificate Authority (CA) procedures to acquire and install root certificates and intermediate certificates.
- When accessing the camera by HTTPS, the image display speed and frame rate of the moving image may reduce.
- When accessing the camera by HTTPS, it may take some time for the images to be displayed.
- When accessing the camera by HTTPS, images may be disturbed and sound may be interrupted.
- The maximum number of cameras that can be connected simultaneously depends on the maximum image size and distribution format.

### ■ Accessing the Camera by HTTPS

#### 1. Launch the web browser in your personal computer.

#### 2. Input the camera's IP address in the address bar of the web browser.

Input address: https://192.168.0.10/

##### <NOTE>

- When the HTTPS port No. is changed from "443", input "https:// camera IP address: Port No." in the address bar.  
E.g. https://192.168.0.11:61443
- When this unit is in a local network, set a proxy server from the web browser (menu bar: [Tools] - [Internet Options]) to ensure that a proxy server is not used for a local address.

#### 3. Press the [Enter] key.

The live screen [Live] is displayed.

The security certificate is installed when the security warning screen is displayed. (→ page 184)

When [User auth.] is set to [On], the user name and password input screen is displayed before the live screen [Live] appears.

##### <NOTE>

- When HTTPS is used, screen and image display may slow down and image update interval (frame rate) may also slow down.

### ● Install the security certificate

When using HTTPS to access the camera, the security warning screen will be displayed if the security certificate of the said camera has not been installed in your personal computer. To prevent this warning screen being displayed, the security certificate must be installed in accordance with the following procedures. If it is not installed, the security warning screen will be displayed every time the camera is accessed.

#### <NOTE>

- The security certificate will be installed to your personal computer based on the content set for [Common Name]. The content set for the "Host Name" must therefore match that set for the address/host name used to access the camera. If the content differs, a security warning screen will be displayed every time the camera is accessed.
- A security warning screen will be displayed if the camera address/host name is changed even when a security certificate has been installed. Reinstall the security certificate.
- When connecting the camera to the Internet, set the address or host name to be accessed from the Internet in [Common Name]. In this case, when accessing the camera locally, a security warning screen is displayed every time the camera is accessed even when a security certificate is installed.
- When the security certificate is correctly installed, an icon of the key will be displayed in the address bar of the web browser accessing the camera.

### 1. Accessing the Camera by HTTPS.

### 2. When the security warning screen is displayed, click [Continue to this website (not recommended)].



The live screen [Live] is displayed.

When the authentication screen is displayed, input the user name and password.

#### <NOTE>

- When the above screen is displayed after accessing a device apart from the camera or a website, there may be a security problem, so check this carefully.

### 3. Click [Certificate error] in the URL and then click [View certificates].



### 4. Click [Install Certificate...].



#### <NOTE>

- If [Install Certificate...] is not displayed, close Internet Explorer and restart it by selecting [Run as Administrator]. Right-click on [Start] - [Program] - [Internet Explorer] and click [Execute as Administrator (A)...].

### 5. Click [Next], which is displayed in the certificate import wizard.





6. Select [Place all certificates in the following store] and click [Browse...].

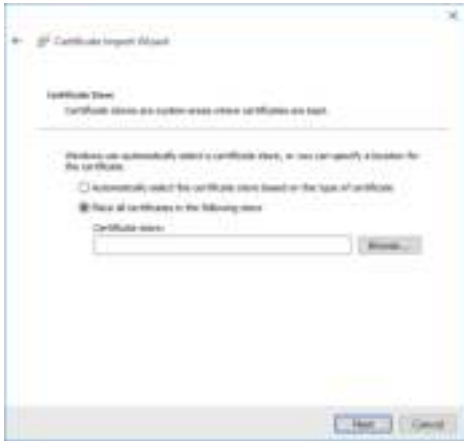

7. Select [Trusted Root Certification Authorities] and click [OK].



8. Click [Next].

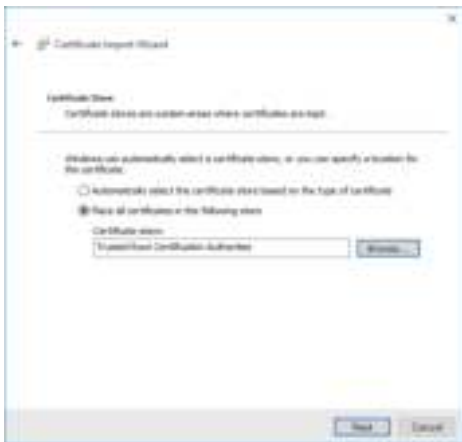

9. Click [Finish].



10. Click [Yes].

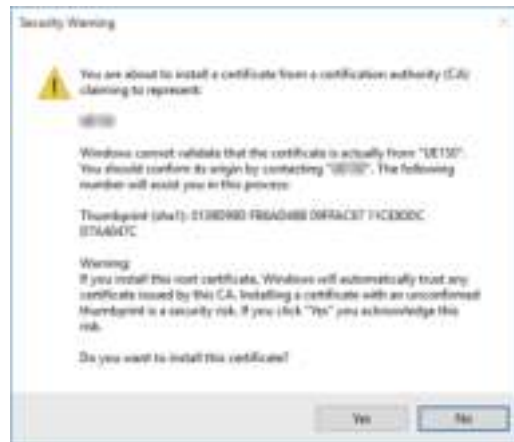

When importing is finished, the "The import was successful." screen is displayed.

11. Click [OK].

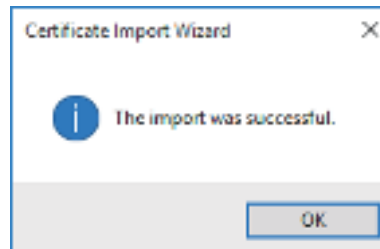

Closing the web browser after importing the certificate and reconnecting to it will stop the "Certificate error" screen being displayed.

### Maintenance screen [Maintenance]

On this screen, you can check the system logs, check the version of the software, initialize the unit, etc.

The Maintenance screen consists of four settings: [System log], [Maintenance], [Product info.] and [Backup].

### ■ System log screen [System log]

A maximum of 1000 event logs and a maximum of 100 error logs can be stored in the unit's internal memory.

When this maximum number has been exceeded, the old logs are overwritten successively by the new logs.

The logs are cleared when the unit's power is turned off.

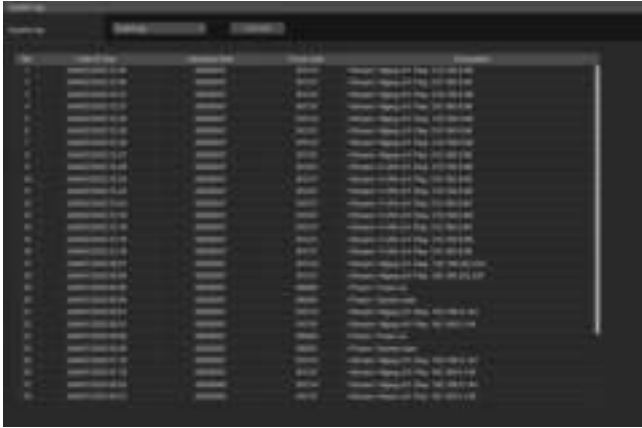

#### <NOTE>

- When the system log screen is displayed, the event log is displayed.

### System log [Event log, Error log1, Error log2]

Switch the display between event logs and error logs.

The event log display is updated when you click the [Execute] button.

Event log	Displays the event logs.
Error log1	Displays the error logs.
Error log2	Displays the error logs.

### [Event log]

#### No.

Displays the log sequence numbers.

"1" indicates the latest information, and up to 1000 logs can be saved.

#### Date & Time

Displays the dates and times when the events occurred.

The dates and times when the events occurred are indicated in 24-hour format according to the clock of the unit.

#### Operation time

Displays the dates and times when the events occurred.

The dates and times when the events occurred are indicated with the hour meter (0h to 99999h) of the unit.

#### Event code

Displays the event code numbers.

#### Description

Displays the event descriptions.

Display examples:

- <Power> Power on.
- <Stream> H.264 ch1 Play.
- <Stream> H.264 ch1 Stop.

### [Error log1, Error log2]

#### No.

Displays the log sequence numbers.

"1" indicates the latest information, and up to 100 logs can be saved.

#### Date & Time

Displays the dates and times when the errors occurred.

The dates and times when the errors occurred are indicated in 24 hour format according to the clock of the unit.

#### Operation time

Displays the dates and times when the errors occurred.

The dates and times when the errors occurred are indicated with the hour meter (0h to 99999h) of the unit.

#### Error code

Displays the error code numbers.

#### Error description

Displays the error descriptions.

Display examples:

- Motor Driver Error
- Temp Sensor Error

### Maintenance screen [Maintenance]

Initialize the setting data of the unit, reboot the unit, etc.



#### Fan1 [Auto, Low, Mid, High]

Set the behavior of cooling fan 1 (on the LENS unit side).

#### Fan2 [Auto, Low, Mid, High]

Set the behavior of cooling fan 2 (on the base unit side).

Auto	Enable automatic control of the cooling fan.
Low	Operate the cooling fan at low speed.
Mid	Operate the cooling fan at medium speed.
High	Operate the cooling fan at high speed.

#### <NOTE>

- Even if this is set to [Low], [Mid], or [High], the cooling fan may be forcibly stopped when the temperature is low.
- Even if this is set to [Low] or [Mid], the cooling fan may be forcibly operated at [High] when the temperature is high.

#### Wireless Control [Enable, Disable]

[Enable] or [Disable] is set here for operations conducted from the wireless remote control.

#### Wireless ID [CAM1, CAM2, CAM3, CAM4]

Set the remote control ID (CAM1 to CAM4).

The [CAM1] to [CAM4] in this setting correspond to the CAMERA <1> to <4> buttons on the wireless remote control.

#### <NOTE>

- When the power is turned on from Standby with the wireless remote control, operations from the wireless remote control are possible irrespective of this setting value.
- This item is not reflected immediately when the setting is changed. It is reflected when the unit is set to Standby mode, and then the power is turned ON with any external device other than the wireless remote control.
- This setting is not reflected when the power is turned ON with this item set to [Disable]. It is reflected when the unit is set to Standby mode, and then the power is turned ON with any external device other than the wireless remote control.

#### Status Lamp [Enable, Disable]

[Disable] or [Enable] is set here for the status display lamp. When you want the status display lamp to stay off while this unit is in operation, set to [Disable].

#### <NOTE>

- Even when set to [Disable], the status display lamp may light up when this unit is starting up, updating firmware, or trouble is occurring.

#### Reset to the default (Except the network settings)

When the [Execute] button is clicked, the unit's settings are returned to their defaults.

When the initialization operation is started, the unit is restarted so no operations can be undertaken for about 2 minutes.

#### <NOTE>

- The following setting items will not be returned to defaults.
  - [Live page - Automatic installation of viewer software]
  - [Live page - Smoother live video display on the browser(buffering)]
  - All settings under [User mng.]
  - All settings under [Network - Network]
  - [HTTPS - Connection]
  - [HTTPS - HTTPS port]
  - [HTTPS - HTTPS mode]
  - HTTPS: CRT key, server certificate
  - All settings under [UPnP]
- [AWB] and [ABB] adjustment values will not be returned to defaults.
- The settings for [Format] and [Frequency] (→ page 112) are not initialized.

#### Reboot

When the [Execute] button is clicked, the unit is rebooted.

After the unit has been rebooted, no operations can be undertaken for about 2 minutes as is the case when the unit's power is turned on.

### ■ Product information screen [Product info.]

The versions of the unit's software can be checked on this screen. The [Model no.], [MAC address(LAN)], [MAC address(SFP+)], [Serial no.], [Firmware version] and other information about the unit is displayed.



#### Model no.

Display the unit's model number.

#### MAC address(LAN)

Display the MAC address of the LAN of this unit.

#### MAC address(SFP+)

Display the MAC address of the SFP+ of this unit.

#### <NOTE>

- This is not displayed when the [Basic Config] – [SFP+Mode] is [12G Output].

#### Serial no.

Display the unit's serial number.

#### Firmware version

Display the overall system version of the unit.

#### Activation

Display information on the activated function.

#### Operation time

Display the hours the unit has been operating.

#### Viewer software installation counter

The number of plug-in viewer software applications which have been installed automatically from the unit is displayed by this counter.

#### OSS license display

When you press the [View] button, the OSS license appears. Press the [Close] button to close the OSS license display screen.

#### Firmware file

Upgrade the firmware.

For details on how to upgrade, see "Upgrading the firmware (Firmware file)" (→ page 188).

### ● Upgrading the firmware (Firmware file)

#### 1. Download the latest software to your personal computer.

##### <NOTE>

- Keep the maximum combined number of characters to be used for the name of the directory in which the software will be stored and for the name of the software which has been downloaded to less than 250 characters.

#### 2. Click the [Select] button, and specify the downloaded software.

#### 3. Click the [Execute] button.

The software upgrade check screen is displayed.

After upgrading the software version, be absolutely sure to delete the temporary Internet files.

##### <NOTE>

- An upgrade progress bar appears after you click the [Execute] button, and the process will take about 1 minute.
- Use the personal computer on the same subnet as the camera to upgrade the software version.
- Before using the version upgrading software, be absolutely sure to check the precautions to be observed, and follow the instructions.
- Use the following files specified by Panasonic Connect Co., Ltd. as the software used for version upgrading.

UPDATE.bin

- While upgrading, the status display lamp of the unit appears as follows:
  - Blinking orange: files being transferred
  - Blinking red: data being written
- Do not turn off the unit's power while a software version is being upgraded. (A pop-up screen will appear to indicate that the process is complete.)
- While a software version is being upgraded, do not attempt to execute any other operations until the version has been upgraded.
- Close the web browser once after performing a version upgrade.
- A maximum of about one hour may be required to upgrade the firmware of the unit.
- The web browser may freeze if version upgrading is performed with Microsoft Edge (IE mode). The version upgrade continues even if this happens, so do not turn off the power of this unit. Keep track of the progress of the upgrade with the status display lamp of the unit (either blinking orange or blinking red).
- If the version is upgraded while [DHCP] is [On], the IP address of the unit may be changed after the restart of the unit after version upgrading. If this occurs, the pop-up screen indicating completion of the version upgrade will not be shown in the web browser, and a timeout may occur. Use the status display lamp of the unit to confirm that the version upgrade is complete.

### ■ Back up screen [Backup]

On this screen, the unit's settings can be saved to a personal computer or settings saved in a personal computer can be loaded into the unit for use.

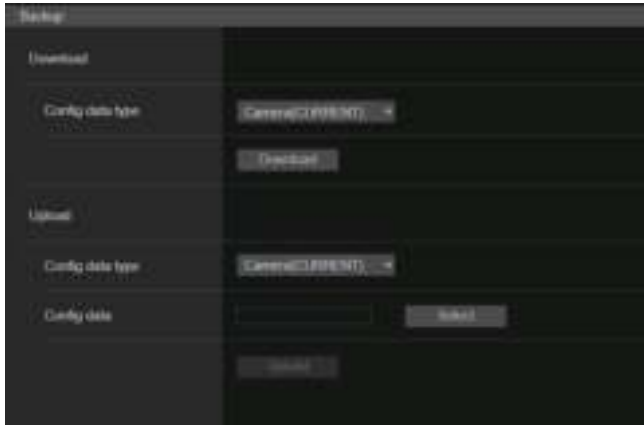

### Download

#### Config data type

[Camera(CURRENT), Camera(SCENE1) to Camera(SCENE8), Camera(USER1) to Camera(USER3), Camera(PRESET), Network]

Specify the type of settings to save when saving the unit's configuration data on the personal computer.

Setting value	Content to be saved	Extension of saving file
Camera(CURRENT)	Current settings	.cs0
Camera(SCENE1)	Settings for Scene1	.cs1
Camera(SCENE2)	Settings for Scene2	.cs2
Camera(SCENE3)	Settings for Scene3	.cs3
Camera(SCENE4)	Settings for Scene4	.cs4
Camera(SCENE5)	Settings for Scene5	.cs5
Camera(SCENE6)	Settings for Scene6	.cs6
Camera(SCENE7)	Settings for Scene7	.cs7
Camera(SCENE8)	Settings for Scene8	.cs8
Camera(USER1)	Settings for User1	.us1
Camera(USER2)	Settings for User2	.us2
Camera(USER3)	Settings for User3	.us3
Camera(PRESET)	Preset	.cpr
Network	Settings of the Web screen Network settings	.nal

### Download

Save the unit's settings onto the personal computer.

When the destination dialog box appears after clicking the [Download] button, specify the destination folder.

#### <NOTE>

- After the [Download] button is clicked, the amount of time it takes for the destination dialog box to appear is about 50 seconds for a camera settings file and about 10 seconds for a network settings file.
- Depending on the status of the unit, it may not be possible to download configuration files. In this case, the unit automatically restarts.

### Upload

#### Config data type

[Camera(CURRENT), Camera(SCENE1) to Camera(SCENE8), Camera(USER1) to Camera(USER3), Camera(PRESET), Network]

Specify the type of configuration data when reflecting the configuration data saved on a personal computer to this unit.

Setting value	File extension suitable for upload
Camera(CURRENT)	.cs0
Camera(SCENE1)	.cs1
Camera(SCENE2)	.cs2
Camera(SCENE3)	.cs3
Camera(SCENE4)	.cs4
Camera(SCENE5)	.cs5
Camera(SCENE6)	.cs6
Camera(SCENE7)	.cs7
Camera(SCENE8)	.cs8
Camera(USER1)	.us1
Camera(USER2)	.us2
Camera(USER3)	.us3
Camera(PRESET)	.cpr
Network	.nal

### Upload

The unit's setting files, which were saved in the personal computer by the download function, are uploaded.

Click the [Select] button to display the dialog box, and specify the saved file.

When you click the [OK] button in the message dialog box that appears after you click the [Upload] button, uploading starts.

Another message dialog box appears after uploading is complete. When you click the [OK] button, the unit will restart automatically.

#### <NOTE>

- Use the files downloaded by the unit as the data to be used for uploading.
- Do not turn off the unit's power while downloading or uploading is underway.
- Do not attempt to perform any operations while downloading or uploading is underway. Instead, wait until the downloading or uploading is completed.
- It takes about 3 minutes for the upload complete dialog box to appear for camera settings files.

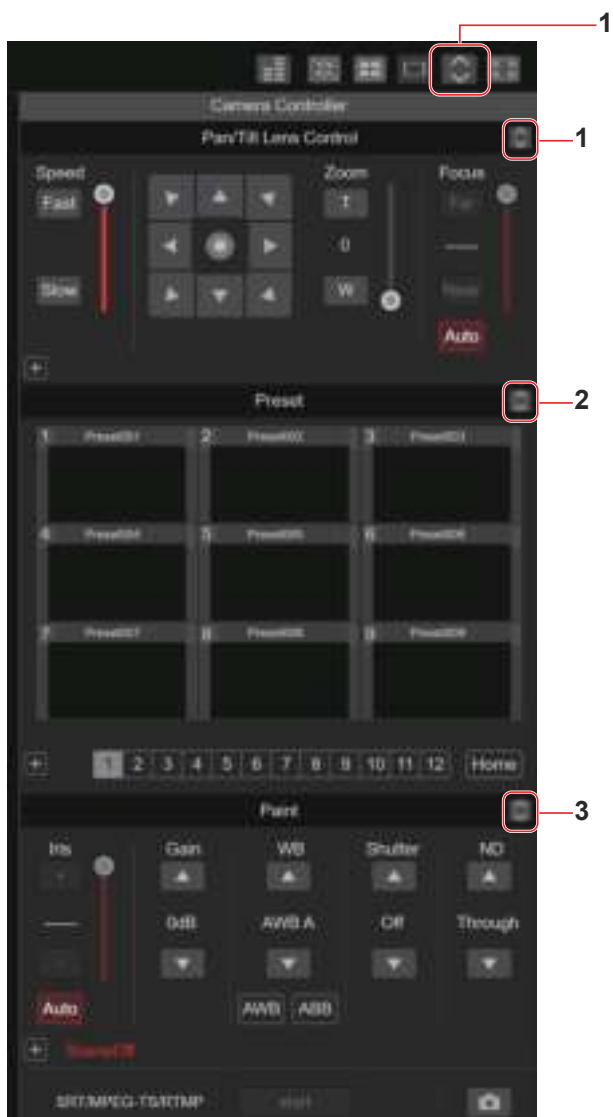

## PTZ operation screen for touch panels



### 1. Button for displaying the PTZ operation screen for touch panels

The screen switches to the one for PTZ operations for touch panels when this button is pressed.

### 2. Button for displaying the Preset operation screen for touch panels

The screen switches to the one for Preset operations for touch panels when this button is pressed.

### 3. Button for displaying the Paint operation screen for touch panels

The screen switches to the one for Paint operations for touch panels when this button is pressed.

### 4. Button for restoring the screen from the touch panel operation screen

Press this button to return to the usual live screen.

### 5. Buttons for switching the touch panel operation screen

Use these to switch the [PTZ]/[Preset]/[Paint] operation screens for touch panels.

### 6. PTZ operation area for touch panels

This is the area where buttons for operating zoom, focus, pan/tilt, and speed are located that are suitable for use with touch panels.

The functionality of the operation buttons is the same as the buttons displayed in the usual live screen.

### 7. SRT/MPEG2-TS/RTMP operation area for touch panels

This is the area where SRT/MPEG2-TS/RTMP operation buttons are located that are suitable for use with touch panels.

The functionality of the operation buttons is the same as the buttons displayed in the usual live screen.

### 8. Snapshot button for touch panels

This snapshot button is suitable for use with touch panels.

The functionality of the operation buttons is the same as the buttons displayed in the usual live screen.

■ Preset operation screen for touch panels

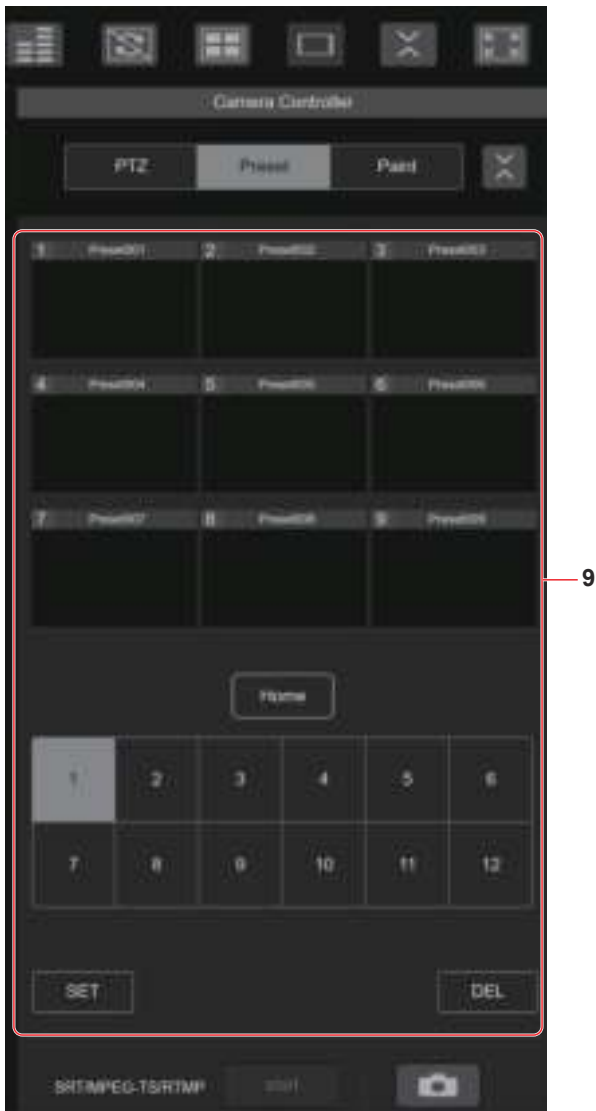

**9. Preset operation area for touch panels**

This is the area where buttons for preset operations are located that are suitable for use with touch panels. The functionality of the operation buttons is the same as the buttons displayed in the usual live screen.

■ Paint operation screen for touch panels



**10. Paint operation area for touch panels**

This is the area where buttons for iris, gain, balance adjustments, shutter, ND filter, and scene operations are located that are suitable for use with touch panels. The functionality of the operation buttons is the same as the buttons displayed in the usual live screen.

■ Setup operation area for touch panels

Even when the Setup screen is displayed, it is possible to display a Setup menu that is suitable for use with touch panels. The functionality of the operation buttons is the same as the buttons displayed in the usual live screen.



# Displaying the web screen using a mobile terminal

It is possible to perform operations using a design suited to mobile terminals in the live screen in a web browser.

## 1. Access the unit from the mobile terminal.

As when accessing the unit from a personal computer, enter [http://IP address/] in the address bar of the web browser on the mobile terminal. The screen for mobile terminals is displayed automatically.

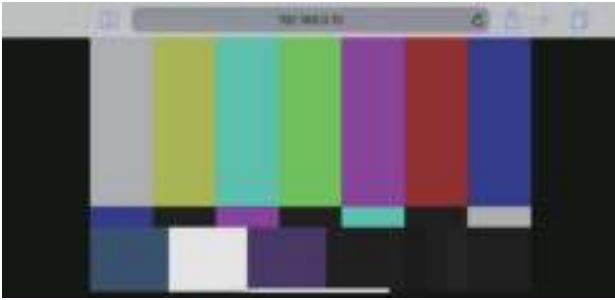

## 2. Switch the display.

The Full Screen mode is engaged and only video is displayed immediately after accessing the unit via a web browser on the mobile terminal. Three types of screen are available on the mobile terminal: "Camera Control", "Full Screen", and "Touch Operation Select".

### Camera Control

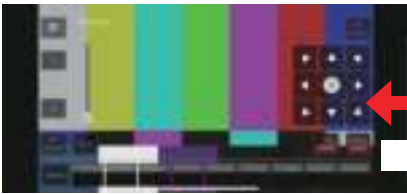

### Full Screen



### Touch Operation Select



Swipe

Swipe

You can switch between Camera Control, Full Screen, and Touch Operation Select by swiping left or right.

When Touch P/T is selected in Touch Operation Select, the middle-click function is enabled in Full Screen mode. Furthermore, when Touch AF is selected, the Touch AF function is enabled in Full Screen mode.

### <NOTE>

- When the button is selected in Touch Operation Select, the screen automatically switches to Full Screen.
- Only images in the M-JPEG format are available for display on mobile terminals.

## Camera control screen [Camera Control]

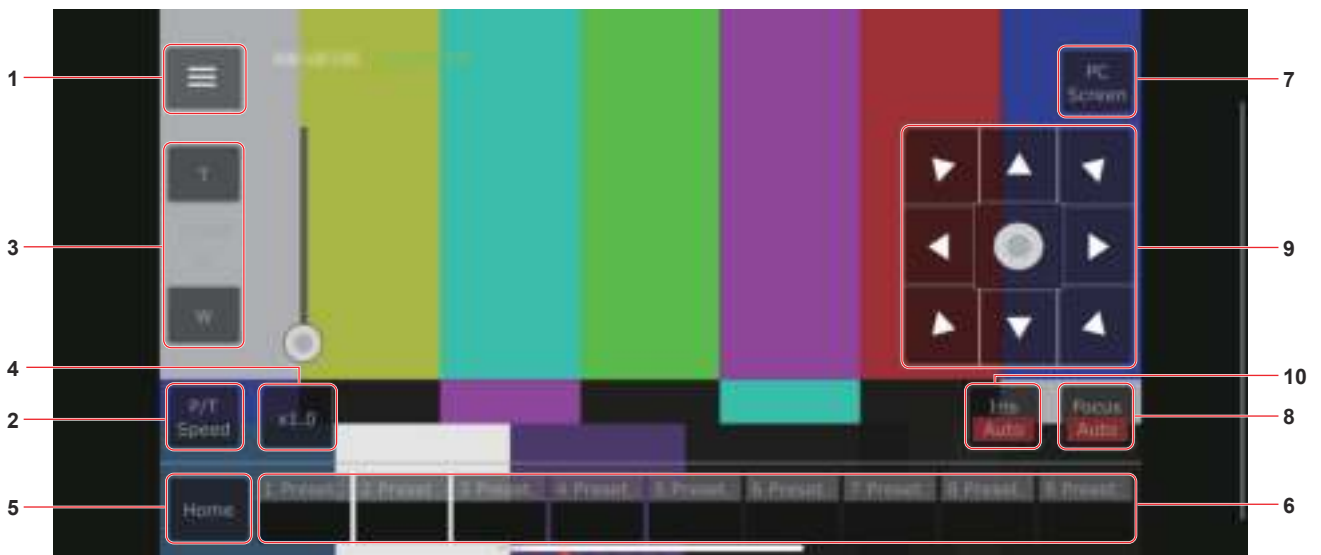



### 1. Button for displaying the operation menu for the live screen

Use this to display the operation menu for the live screen.



#### < Live

Use this to close the operation menu for the live screen.

#### Power

Switch Power On/Standby.

For details, refer to the [Power On] button and [Standby] button.

#### Compression

As only JPEG images can be displayed on mobile terminals, only the [JPEG] button is displayed.

#### Streaming

Switch between JPEG(1)/JPEG(2)/JPEG(3).

For details, refer to [Stream].

#### Zoom

Enable or disable [D-Zoom], [D-Ext. ×1.4], and [D-Ext. ×2.0].

For details, refer to [Zoom].

#### Stream (SRT/RTMP)

Starts streaming transmission to the RTMP/RTMPS server or the SRT compatible decoder that was pre-registered.

#### Lock(WEB)

Enable or disable [Lock(WEB)].

For details, refer to Operation lock button [Lock].

#### Color Bar

Switch the color bar signal displayed or hide.

#### Bar Type

Switch the color bar displayed between Type1 and Type2.

### 2. Button for switching P/T Speed/Zoom

Use this to switch the buttons in the operation area.

When this is pressed while [P/T Speed] is being displayed, this displays the speed [Speed] button/slider in the operation area.

When this is pressed while [Zoom] is being displayed, this displays the zoom [Zoom] button/slider in the operation area.

### 3. P/T Speed/Zoom operation area

The [P/T Speed]/[Zoom] button/slider is displayed.

Switch between [P/T Speed] and [Zoom] with the button for switching P/T Speed/Zoom.

- The functionality of the operation buttons is the same as the buttons displayed in the usual live screen.

### 4. ×1.0 button

Use this to adjust the zoom (magnification) to 1.0x.

### 5. Home button

Move to the preset home position.

### 6. Preset thumbnail operation area

When a preset thumbnail is clicked, the camera moves to face towards a preset position that was registered beforehand.

By swiping left in the preset thumbnail operation area, preset thumbnails that are not displayed can be displayed.

- You can select Preset1 to Preset100.

### 7. Button for switching the personal computer screen

This is used for switching to the live screen display for a personal computer.

Press the mobile screen display button on the live screen for personal computers to return to the mobile live screen.

Mobile screen display button: 

### 8. Button for switching PTZ/Focus

Use this to switch the buttons in the operation area.

When this is pressed while [PTZ] is being displayed, this displays the control pad buttons in the operation area.

When this is pressed while [Focus Manual] or [Focus Auto] is being displayed, this displays the [Focus] button/slider in the operation area.

### 9. PTZ/Focus operation area

The [PTZ]/[Focus] button/slider is displayed.

Switch between [PTZ] and [Focus] with the button for switching PTZ/Focus.

- The functionality of the operation buttons is the same as the buttons displayed in the usual live screen.

### 10. Focus (AUTO)/Iris (AUTO) button

When [PTZ] is selected with the button for switching [PTZ]/[Focus], the button for enabling or disabling Iris (Auto) is displayed.

When [Focus] is selected, the button for enabling or disabling Focus (Auto) is displayed.

## ■ Control Area

In the Control Area, operations by operation buttons are prioritized.

Scrolling of the screen as a whole can be done with touch operations outside the Control Area.



#### <NOTE>

- Depending on the mobile terminal you are using, it may be necessary to scroll the screen as a whole to adjust the position of the Control Area.

## Limiters

---

This unit comes with settings (referred to as “limiters”) that restrict the panning and tilting movement ranges.

Depending on the installation location, obstacles that may come into contact with the remote camera may exist within its movement range. In such cases, setting the limiters before the obstacles will prevent contact.

The positions of four limiters — namely, the upper, lower, leftmost and right-most limits of the travel range — can be set. Once they have been set, the positions will not be lost even after the power has been turned off.

The limiters can be set or released both by the wireless remote control and controller or web setting screen [Setup]. Whatever was set or released last takes precedence. For the controller operations, refer to the Operating Instructions of the controller.

The settings of the limiters using the wireless remote control will be described here.

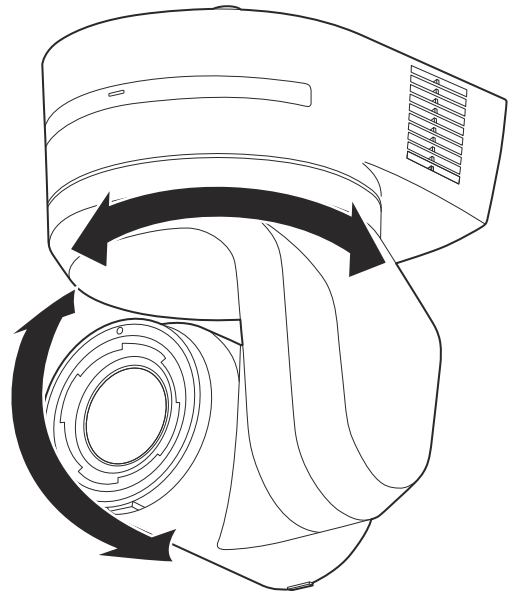

# Setting/releasing the limiters

## Basic limiter operations

### 1. Press the <MENU> button.

Tap the button (rather than pressing it). When it is pressed for 2 seconds, the camera menu will appear. If this happens, press the <MENU> button again for 2 seconds to clear the camera menu.

Then start again from step 1.

### 2. Press the <▲/▼/◀/▶> button for 2 seconds while holding down the <PRESET> button.

The limiter for the upper limit, lower limit, left limit or right limit is set (or released) using these direction buttons, respectively. The tally lamp will blink at this time. When a limiter is set, it blinks once; when a limiter is released, it blinks twice.

If any other button was operated between steps 1 and 2, start again from step 1.

## Setting the limiters

The limiter positions can be set by following the steps below. When the position is set, the tally lamp blinks once.

### 1. Press one of the CAMERA<1> to <4> button to select the unit.

#### • Setting the upper limit position of the movement range

Press the <▲> or <▼> button of the wireless remote control to turn the unit as far as the position which will serve as the upper limit.

Next, perform the steps in "Basic limiter operations". (Press the <MENU> button quickly and then press the <▲> button for 2 seconds while holding down the <PRESET> button.)

#### • Setting the lower limit position of the movement range

Press the <▲> or <▼> button of the wireless remote control to turn the unit as far as the position which will serve as the lower limit.

Next, perform the steps in "Basic limiter operations". (Press the <MENU> button quickly and then press the <▼> button for 2 seconds while holding down the <PRESET> button.)

#### • Setting the left-most limit position of the movement range

Press the <◀> or <▶> button of the wireless remote control to turn the unit as far as the position which will serve as the left-most limit.

Next, perform the steps in "Basic limiter operations". (Press the <MENU> button quickly and then press the <◀> button for 2 seconds while holding down the <PRESET> button.)

#### • Setting the right-most limit position of the movement range

Press the <◀> or <▶> button of the wireless remote control to turn the unit as far as the position which will serve as the right-most limit.

Next, perform the steps in "Basic limiter operations". (Press the <MENU> button quickly and then press the <▶> button for 2 seconds while holding down the <PRESET> button.)

## Releasing the limiters

The limiter positions that are set can be released by following the steps below.

When the position is released, the tally lamp blinks twice.

### 1. Press one of the CAMERA <1> to <4> button to select the unit.

### 2. Release the limiters by taking the steps below.

#### • Releasing the upper limit position of the movement range

Perform the steps in "Basic limiter operations". (Press the <MENU> button quickly and then press the <▲> button for 2 seconds while holding down the <PRESET> button.)

#### • Releasing the lower limit position of the movement range

Perform the steps in "Basic limiter operations". (Press the <MENU> button quickly and then press the <▼> button for 2 seconds while holding down the <PRESET> button.)

#### • Releasing the left-most limit position of the movement range

Perform the steps in "Basic limiter operations". (Press the <MENU> button quickly and then press the <◀> button for 2 seconds while holding down the <PRESET> button.)

#### • Releasing the right-most limit position of the movement range

Perform the steps in "Basic limiter operations". (Press the <MENU> button quickly and then press the <▶> button for 2 seconds while holding down the <PRESET> button.)

## Resetting the limiters

To reset the limiters, the currently established settings must be released. The limiter positions that are set can be reset by following the steps below.

### 1. Release the settings of the limiter positions to be reset by following the steps in "Releasing the limiters".

### 2. Set the limiter positions by following the steps in "Setting the limiters".

## Safe mode

---

### Concerning the safe mode

The unit goes into the safe mode when the pan-tilt head is forcibly moved by an external force or when something impedes its rotation. Once the safe mode has been established, some or all of the operations will no longer be acknowledged to ensure safety and prevent equipment damage.

### Detection of equipment trouble

When the unit has detected trouble, its functions are shut down, then the unit is restarted or the initial setting operation is performed, and the normal condition of the unit is restored after about 30 seconds.

#### <NOTE>

- When trouble is detected, pictures may no longer be output for a while, but they will be restored in 5 seconds to 10 seconds.

# Troubleshooting

## ■ Operation

Symptom	Cause and solution	Reference pages
No power	<ul style="list-style-type: none"> <li>Is the AC cable of the external DC power supply securely connected to the AC outlet?</li> </ul>	---
	<ul style="list-style-type: none"> <li>If the power plug of the external DC power supply connected properly?</li> </ul>	---
	<ul style="list-style-type: none"> <li>Is the LAN cable connected securely to the LAN connector for IP control &lt;LAN LINK/ACT&gt;?</li> </ul>	page 18
	<ul style="list-style-type: none"> <li>Is the network cable for the PoE++ (IEEE 802.3bt compliant) compatible power supply device and the unit connected properly?</li> </ul>	Installation Instructions → "Connections" → "System example 3 (IP image transmission, PoE++)"
	<ul style="list-style-type: none"> <li>Power may not be supplied if the total power limit is exceeded on power supply devices that allow connections to multiple PoE++ terminals. → For details, refer to the operating instructions for the PoE++ power supply device.</li> </ul>	---
	<ul style="list-style-type: none"> <li>If the unit is connected to the controller, has it been connected properly? → For details, refer to the operating instructions for the controller.</li> </ul>	Installation Instructions → "Connections"
	<ul style="list-style-type: none"> <li>When performing operations from a wireless remote control → Also refer to the "Cannot operate using the wireless remote control" item.</li> </ul>	---
Cannot operate (common to wireless remote control, controller)	<ul style="list-style-type: none"> <li>Is the power on? → If the unit's status display lamp is off or lights up orange, it means that the unit's power is not on.</li> </ul>	page 37
	<ul style="list-style-type: none"> <li>The safe mode function may have been activated.</li> </ul>	page 196
	<ul style="list-style-type: none"> <li>Have the limiter functions been set?</li> </ul>	pages 194 to 195
	<ul style="list-style-type: none"> <li>Has the unit you want to operate been selected properly?</li> </ul>	page 38
Cannot operate using the wireless remote control	<ul style="list-style-type: none"> <li>Have the remote control's batteries run down or have the batteries been installed with their polarities reversed? → If the status display lamp does not blink even when the wireless remote control is operated near the wireless remote control signal light-sensing area, it means that the batteries have run down. Replace the batteries.</li> </ul>	---
	<ul style="list-style-type: none"> <li>Have the wireless remote control ID settings (CAMERA &lt;1&gt; to &lt;4&gt;) been set correctly?</li> </ul>	page 32
	<ul style="list-style-type: none"> <li>Is there a fluorescent light or plasma monitor near the unit and, if so, is the wireless remote control signal light-sensing area exposed to its light?</li> </ul>	page 17
Cannot operate using the controller	<ul style="list-style-type: none"> <li>Is the unit connected to the controller properly? → For details, refer to the operating instructions for the controller.</li> </ul>	Installation Instructions → "Connections"
	<ul style="list-style-type: none"> <li>Has the initial account been set up? → If the initial account has not been set up yet, this unit can be recognized by either AW-RP150 or AW-RP60, but they are not able to control it.</li> </ul>	page 34
	<ul style="list-style-type: none"> <li>Has digest authentication for this unit been set to ON ([User auth.] is [On] and [Authentication] is [Digest]) and the [Wait time mode] has been set to [Mode1]? → When using a Panasonic controller (AW-RP150, AW-RP60), set [Wait time mode] to [Mode2] when using digest authentication. Smooth operation may be diminished when [Wait time mode] is set to [Mode1].</li> </ul>	page 167
	<ul style="list-style-type: none"> <li>It may be necessary to upgrade the version of the controller so that the controller will support the unit. → For details on upgrading, visit the support page on the following website. <a href="https://pro-av.panasonic.net/en/">https://pro-av.panasonic.net/en/</a></li> </ul>	---
The unit turns in the opposite direction to the one operated	<ul style="list-style-type: none"> <li>Has the stand-alone (Desktop) installation setting been selected correctly?</li> </ul>	page 74, page 117
	<ul style="list-style-type: none"> <li>The reversal setting may have been established at the controller if the unit is connected to the controller. → For details, refer to the operating instructions for the controller.</li> </ul>	---

## Troubleshooting (continued)

Symptom	Cause and solution	Reference pages
Cannot access from a web browser	<ul style="list-style-type: none"> <li>• <b>Has a LAN cable of category 5e or above been connected to the LAN connector for IP control &lt;LAN LINK/ACT&gt;?</b></li> </ul>	Installation Instructions → "Connections"
	<ul style="list-style-type: none"> <li>• <b>Is the [LINK] LED of the LAN connector for IP control lit?</b> → If it is not lit, it means that something is wrong with the connection to the LAN or that the network at the connection destination is not working properly. Check the LAN cable for defective contacts, and check the wiring.</li> </ul>	page 18
	<ul style="list-style-type: none"> <li>• <b>Is the power on?</b> → If the unit's status display lamp is off or lights up orange, it means that the unit's power is not on.</li> </ul>	page 37
	<ul style="list-style-type: none"> <li>• <b>Has a valid IP address been set in the unit?</b></li> </ul>	page 168
	<ul style="list-style-type: none"> <li>• <b>Has the wrong IP address been accessed?</b> → Check the connections by following the steps below. <b>For Windows:</b> Using the Windows command prompt, execute &gt; ping [IP address which has been set in the camera] A reply returned from the unit signifies that there are no problems in operation. If a reply is not received, try following operation: • Restart the unit, then use the EasyIP Setup Tool Plus within 20 minutes to change the IP address. <b>For Mac:</b> Using the macOS terminal, execute &gt; ping -c 10 [IP address which has been set in the camera] A reply returned from the unit signifies that there are no problems in operation.</li> </ul>	---
	<ul style="list-style-type: none"> <li>• <b>Are you accessing via "http://" while the HTTPS function is enabled?</b> → Perform access via "https://" when using the HTTPS function. Entry of the port number is also required.</li> </ul>	page 183
	<ul style="list-style-type: none"> <li>• <b>Is the same IP address setting being used by another unit?</b> → Check out the IP addresses of the unit, access devices (personal computer, controller, etc.) and any other cameras.</li> </ul>	page 51
	<ul style="list-style-type: none"> <li>• <b>Does the subnet mask setting match the network subnet of the connection destination?</b> → Check out the subnet mask settings of the unit and access devices, and then consult with the network administrator.</li> </ul>	page 51
	<ul style="list-style-type: none"> <li>• <b>Has the "Use a proxy server" setting been selected by the web browser? (When the unit and the personal computer are connected to the same subnet)</b> → If a proxy server has been set using the [proxy setting] of the web browser, it is recommended that a "Don't use proxy" address be selected as the unit's IP address setting.</li> </ul>	---
<ul style="list-style-type: none"> <li>• <b>Has the wrong default gateway been set for the unit? (When the unit and personal computer are connected to different subnets)</b> → Check out the default gateway that has been set for the unit, and then consult with the network administrator.</li> </ul>	page 51	

## Troubleshooting (continued)

Symptom	Cause and solution	Reference pages
The settings on the web setting screen [Setup] are not updated or displayed properly	<b>For Windows:</b> <ul style="list-style-type: none"> <li>Press the [F5] key on the keyboard of the personal computer to request that the settings be acquired.</li> </ul> <b>For Mac:</b> <ul style="list-style-type: none"> <li>Press the [Command] + [R] key on the personal computer's keyboard to request that the settings be acquired.</li> </ul>	---
	<ul style="list-style-type: none"> <li>Perform the following to delete the temporary Internet files. <b>For Windows:</b> <ol style="list-style-type: none"> <li>Select [Tools] - [Internet Options] in Internet Explorer.</li> <li>Click the [General] tab, and click the [Delete] button under [Browsing history].</li> <li>In the [Delete Browsing History] dialog box, select the [Temporary Internet files and website files] checkbox, and then click [Delete].</li> <li>Click the [OK] button.</li> </ol> <b>For Mac:</b> <ol style="list-style-type: none"> <li>Select [Develop] - [Empty Cache] in Safari.</li> <li>Click [Empty] in the [Are you sure you want to empty the cache?] pop-up screen.</li> </ol> </li> </ul>	---
	<b>For Windows:</b> <ul style="list-style-type: none"> <li>If [Check for newer versions of stored pages] is not set to [Every time I visit the webpage] in the temporary Internet file settings, the web setup screen may not appear. <ul style="list-style-type: none"> <li>Perform the following. <ol style="list-style-type: none"> <li>Select [Tools] - [Internet Options] in Internet Explorer.</li> <li>Click the [General] tab, and click the [Settings] button under [Browsing history].</li> <li>In the [Temporary Internet Files] dialog box, select the [Every time I visit the webpage] option under [Check for newer versions of stored pages].</li> <li>Click the [OK] button.</li> </ol> </li> </ul> </li> </ul>	---
	<ul style="list-style-type: none"> <li>The unit's ports may be filtered by the firewall or other function of the anti-virus software. <ul style="list-style-type: none"> <li>Change the HTTP port number of the unit to a port number that will not be filtered.</li> </ul> </li> </ul>	---
It is not possible to download the setting files	<b>For Windows:</b> <ul style="list-style-type: none"> <li>Has the file download function been disabled? <ul style="list-style-type: none"> <li>Perform the following. <ol style="list-style-type: none"> <li>Select [Tools] - [Internet Options] in Internet Explorer.</li> <li>Click the [Security] tab, and click the [Custom level] button under [Security level for this zone].</li> <li>In the [Security Settings] dialog box, select the [Enable] option for [File download].</li> <li>Click the [OK] button.</li> <li>Click the [OK] button.</li> </ol> </li> </ul> </li> </ul>	---
The tally lamps do not light	<ul style="list-style-type: none"> <li>Is the [TALLY] setting set to [DISABLE]? <ul style="list-style-type: none"> <li>If [TALLY] is set to [DISABLE], the unit's tally lamp does not light. Change the setting to [ENABLE].</li> </ul> </li> </ul>	page 49, page 115
Status display lamp does not light	<ul style="list-style-type: none"> <li>Is the [STATUS LAMP] setting set to [DISABLE]? <ul style="list-style-type: none"> <li>If [STATUS LAMP] is set to [DISABLE], the status display lamp does not light when this unit is working properly. Change the setting to [ENABLE].</li> </ul> </li> </ul>	page 83
The authentication screen appears repeatedly	<ul style="list-style-type: none"> <li>Has the user name or password been changed? <ul style="list-style-type: none"> <li>If you change the user name and password of the user currently logged in from a separate web browser while the unit is being accessed, the authentication screen appears each time the screen display is changed. Close the web browser, and initiate access to the unit again.</li> </ul> </li> </ul>	page 167
	<ul style="list-style-type: none"> <li>Has the method for user authentication been changed? <ul style="list-style-type: none"> <li>If you change the [User auth.] - [Authentication] setting, close the web browser and initiate access again.</li> </ul> </li> </ul>	page 167
Screens displays take a while to appear	<ul style="list-style-type: none"> <li>Is access being performed in HTTPS mode? <ul style="list-style-type: none"> <li>Screen displays may take a while to appear in HTTPS mode due to signal processing.</li> </ul> </li> </ul>	---
	<ul style="list-style-type: none"> <li>Is the unit on the same local network and being accessed via proxy? <ul style="list-style-type: none"> <li>Configure the web browser settings so that access is not performed via proxy.</li> </ul> </li> </ul>	---
	<ul style="list-style-type: none"> <li>Are multiple users accessing the unit's IP images at the same time? <ul style="list-style-type: none"> <li>When multiple users access the unit's IP images at the same time, images may take some time to appear, and the frame rate of the IP images may drop.</li> </ul> </li> </ul>	---

■ Video

Symptom	Cause and solution	Reference pages
No pictures are displayed or the pictures are disturbed	• Has the unit been connected properly to the other connected devices?	Installation Instructions → "Connections"
	• If the system is configured in such a way that the picture is also switched when the unit to be operated is selected, has the correct unit been selected?	page 38
	• Has the image signal setting been selected correctly?	page 48, page 113
	• Are external sync signals that are supported by the video signal format which has been set being input?	page 20
The picture is flipped vertically	• Has the stand-alone (Desktop) installation setting been selected correctly?	page 74, page 117
Multiple color bands (color bars) are displayed	• Switch to the camera picture.	page 40
The menu screen is displayed	• Exit the camera menu.	page 31
It is difficult to view the menu screens	<ul style="list-style-type: none"> <li>• Depending on the HDMI monitor you are using, you may experience one or more of the symptoms described below. <ul style="list-style-type: none"> <li>• The resolution of the characters in the camera menu displays changes as the background image changes.</li> <li>• Depending on the edge enhancement setting established for the monitor, white lines appear in front of the black shadows of the camera menus.</li> <li>• Depending on the edge enhancement setting established for the monitor, the background colors may be superimposed onto the white parts of the camera menus.</li> </ul> </li> </ul>	---
No auto focusing	<ul style="list-style-type: none"> <li>• Is the focus set to manual? → Auto focusing is initiated as soon as the focus is set to auto.</li> </ul>	page 40
	<ul style="list-style-type: none"> <li>• In some situations, it may be hard to focus at the auto setting. → In cases like this, select the manual setting, and focus manually.</li> </ul>	page 42
The subject is not brought into focus during zooming when the manual setting is used for the focus	<ul style="list-style-type: none"> <li>• Was the focus adjusted at the Tele end? → First adjust the focus at the Tele end where the focusing accuracy is higher, and then proceed with the zooming.</li> </ul>	---
	<ul style="list-style-type: none"> <li>• Under some operating conditions, it may be hard to bring subjects into focus. → In such cases, use the focus at the auto setting.</li> </ul>	page 40
Focusing is not possible in night mode	<ul style="list-style-type: none"> <li>• Are you shooting with visible light? → The focus position is different due to the difference in refractive index between visible light and infrared light. Wavelengths near 850 nm are assumed for infrared light in night mode on this unit. Perform manual adjustment if necessary.</li> </ul>	page 42
Something is wrong with the coloring of the pictures	• Activate the ATW (Auto tracking white adjustment) function.	page 45
	<ul style="list-style-type: none"> <li>• In some situations, the proper colors may not be reproduced using the ATW function. → In cases like this, proceed with the white balance adjustment.</li> </ul>	pages 44 to 45
The pictures are too light or too dark	• Either select the auto setting for the iris or select the manual setting and adjust the iris manually.	page 42
	• The pictures may be dark if the analog video signal cables are too long because this will cause signal attenuation.	---
Images are in black and white	<ul style="list-style-type: none"> <li>• Is the unit in night mode? → In night mode, output will be in black and white.</li> </ul>	page 58, page 143
Auto white balance adjustment (AWB) is not possible	<ul style="list-style-type: none"> <li>• Is the unit in night mode? → Auto white balance adjustment (AWB) is not possible in night mode.</li> </ul>	page 58, page 143



## Troubleshooting (continued)

Symptom	Cause and solution	Reference pages
The screen is too bright in night mode	<ul style="list-style-type: none"> <li>The aperture is set to open in night mode to prevent video voyeurism. Adjust the brightness at the light source.</li> </ul>	page 42
The iris does not operate in night mode		
The subjects appear distorted	<ul style="list-style-type: none"> <li>Since this camera uses an MOS imaging device, the pickup timing differs slightly at the top left and bottom right of the screen. This means that if a subject moves quickly across the front of the camera, it may appear slightly distorted. This is not a malfunction.</li> </ul>	---
When the flash is fired during shooting, only the top or bottom of the screen becomes lighter	<ul style="list-style-type: none"> <li>With a MOS imaging sensor, the pickup timing differs slightly at the top left and bottom right of the screen. This means that when the flash is fired, the bottom of the screen will become lighter in the field concerned and the top will become lighter in the next field. This is normal and not indicative of any problem.</li> </ul>	---
The brightness changes cyclically or the colors change, and horizontal stripes can be seen passing across the screen	<ul style="list-style-type: none"> <li>These phenomena (flicker) may occur under the illumination produced by fluorescent lighting, mercury bulbs or other types of discharge tubes. In such cases, we recommend setting the electronic shutter speed to 1/100 in regions with 50 Hz power supply frequency, and to OFF in regions with 60 Hz power supply frequency.</li> </ul>	---
When fine lines or cyclical patterns are shot, flickering is seen or coloring is added to them	<ul style="list-style-type: none"> <li>This phenomenon occurs because the pixels are arranged systematically on each image sensor. It is noticeable when the spatial frequency of a subject and the pixel pitch are brought into proximity so change the camera angle or take other action.</li> </ul>	---
Noise occurs in the audio input	<ul style="list-style-type: none"> <li>The following causes are possible. <ul style="list-style-type: none"> <li>The camera, switching hub, or peripheral devices are not grounded.</li> <li>Power lines are running nearby.</li> <li>Equipment generating strong electric or magnetic fields (e.g., television and radio antennas, air conditioning motors, power transformers) are located nearby.</li> </ul> </li> </ul> <p>If the problem cannot be resolved via movement of surrounding devices, use a microphone equipped with an amplifier, or connect an audio output with low output impedance.</p>	page 8

■ IP images

Symptom	Cause and solution	Reference pages
Images are not displayed	<b>For Windows:</b> <ul style="list-style-type: none"> <li>• <b>Is the plug-in viewer software installed?</b> → Install the plug-in viewer software.</li> </ul>	page 35
	<b>For Windows:</b> <ul style="list-style-type: none"> <li>• <b>If [Check for newer versions of stored pages] is not set to [Every time I visit the webpage] in the temporary Internet file settings, IP images may not appear in the live screen [Live].</b> → Perform the following.                             <ol style="list-style-type: none"> <li>① Select [Tools] - [Internet Options] in Internet Explorer.</li> <li>② Click the [General] tab, and click the [Settings] button under [Browsing history].</li> <li>③ In the [Temporary Internet Files] dialog box, select the [Every time I visit the webpage] option under [Check for newer versions of stored pages].</li> <li>④ Click the [OK] button.</li> </ol> </li> </ul>	---
The images are blurry	<ul style="list-style-type: none"> <li>• <b>Is the focus properly adjusted?</b> → Check the focus adjustment.</li> </ul>	---
Images are not updated	<ul style="list-style-type: none"> <li>• <b>The images may not be updated and other problems may occur depending on your web browser and its version.</b></li> <li>• <b>The images may stop depending on the network congestion, the level of access to the unit, etc.</b></li> <li>• <b>If the IP video settings of the unit were changed, the image display may stop temporarily.</b> → Check the level of access to the unit, and stop any unnecessary access. Afterward, check the following.                             <p><b>For Windows:</b> Press the [F5] key on the personal computer's keyboard to request that the settings be acquired.</p> <p><b>For Mac:</b> Press the [Command] + [R] key on the personal computer's keyboard to request that the settings be acquired.</p> </li> </ul>	---
The images do not update or display properly	<ul style="list-style-type: none"> <li>• <b>Perform the following to delete the temporary Internet files.</b> <p><b>For Windows:</b></p> <ol style="list-style-type: none"> <li>① Select [Tools] - [Internet Options] in Internet Explorer.</li> <li>② Click the [General] tab, and click the [Delete] button under [Browsing history].</li> <li>③ In the [Delete Browsing History] dialog box, select the [Temporary Internet files and website files] checkbox, and then click [Delete].</li> <li>④ Click the [OK] button.</li> </ol> <p><b>For Mac:</b></p> <ol style="list-style-type: none"> <li>① Select [Develop] - [Empty Cache] in Safari.</li> <li>② Click [Empty] in the [Are you sure you want to empty the cache?] pop-up screen.</li> </ol> </li> </ul>	---
	<ul style="list-style-type: none"> <li>• <b>The unit's ports may be filtered by the firewall or other function of the anti-virus software.</b> → Change the HTTP port number of the unit to a port number that will not be filtered.</li> </ul>	---
H.264 images are not displayed	<ul style="list-style-type: none"> <li>• <b>If the "Network Camera View 4S" plug-in viewer software is deleted in an environment where the "Network Camera View 3" plug-in viewer software is installed, display of H.264 images will become impossible. In such cases, delete "Network Camera View 3" before installing "Network Camera View 4S".</b></li> </ul>	---
	<ul style="list-style-type: none"> <li>• <b>Has the camera been connected to a personal computer via a router (via the Internet, for example)?</b> → If UDP port transfer has not been set correctly, H.264 images cannot be displayed. H.264 can be transferred by HTTP when [Internet mode(Over HTTP)] is set to [On].</li> <li>• <b>Has UDP communication been blocked by security software or a firewall?</b> → If [Internet mode(Over HTTP)] is [Off], H.264 is transferred by UDP. → Change the settings in the security software and firewall, and change the settings to permit communications with your web browser.</li> </ul>	page 127
The images are distorted	<ul style="list-style-type: none"> <li>• <b>The images may be distorted if the transmission path is congested and proper transmission is not possible.</b> → Consult your network administrator.</li> </ul>	---
	<ul style="list-style-type: none"> <li>• <b>The images may be distorted if video packet shuffling occurs on the transmission path.</b> → Switching to an identical Internet service provider for both the camera and the personal computer may prevent this problem. Consult your network administrator.</li> </ul>	---

## Troubleshooting (continued)

Symptom	Cause and solution	Reference pages
<p><b>When multiple web browsers are running to display H.264 images, images from multiple cameras appear sequentially in a single web browser</b></p>	<p><b>For Windows:</b></p> <ul style="list-style-type: none"> <li>• <b>This may occur depending on the combination of the personal computer's display adaptor and the driver.</b> <ul style="list-style-type: none"> <li>→ If this occurs, update the first display adaptor to the latest version. If this does not resolve the problem, adjust the hardware accelerator function as follows. This section describes the procedure for Windows 10 as an example. Changing the settings may not be possible, depending on your environment.               <ol style="list-style-type: none"> <li>① Right-click on the desktop, and select [Display settings] from the menu.</li> <li>② Click [Advanced display settings].</li> <li>③ Select the [Troubleshooting] tab, and click [Change Settings].</li> <li>④ Change to [Hardware acceleration] setting to [disable] at the far left, and click [OK].</li> </ol> </li> </ul> </li> </ul>	<p>---</p>
<p><b>Audio is not output for NDI HX-compatible switchers</b></p>	<ul style="list-style-type: none"> <li>• <b>[Audio] may be set to [Off] in the audio setting screen [Audio].</b> <ul style="list-style-type: none"> <li>→ Reset the setting to [On].</li> </ul> </li> </ul>	<p>page 140</p>
<p><b>Images stop in applications that support High bandwidth NDI</b></p>	<ul style="list-style-type: none"> <li>• <b>When a personal computer and this unit are connected via a commercially available USB LAN conversion adaptor, the images may stop due to network problems on the personal computer side.</b> <ul style="list-style-type: none"> <li>→ If this phenomena occurs, firstly disable the network adaptor that is connecting the personal computer to this unit, then change [Streaming mode] in [Video over IP] to [H.264]. After this, re-enable the network adaptor that you disabled and the images will be output when you change the [Streaming mode] to [High bandwidth NDI].</li> </ul> </li> </ul>	<p>page 125</p>

## Troubleshooting (continued)

### ■ Web screen

Depending on the OS installed on the personal computer, the following may occur. Follow the instructions below when the following has occurred. Performing the following solutions will not affect the operation of other applications.

Symptom	Cause and solution	Reference pages
Frame dropping is observed in images	<ul style="list-style-type: none"> <li>• <b>The personal computer may be lacking in performance.</b> → Check the requirements for the personal computer environment.</li> </ul>	page 10
	<ul style="list-style-type: none"> <li>• <b>This phenomenon may be improved by pressing the button for switching real time updating to disable the web browser real time updating function.</b></li> </ul>	page 109

### For Windows:

The "information bar" described in the following explanations refers to the message bars that appear in Internet Explorer 11. The information bar appears at the bottom of Internet Explorer.



Symptom	Cause and solution	Reference pages
The following message appears in the information bar. "This website wants to run the following add-on: 'WebVideo Module' from 'Panasonic System Networks Co., Ltd.'"	<ul style="list-style-type: none"> <li>• Select [Allow].</li> </ul>	---
The following message appears in the information bar. "This website wants to install the following add-on: 'nwcV4SSetup.exe' from 'Panasonic System Networks Co., Ltd.'"	<ul style="list-style-type: none"> <li>• Select [Install]. When the security warning window appears, click the [Install] button.</li> </ul>	---
An unnecessary status bar or scroll bar is displayed on the pop-up window	<ul style="list-style-type: none"> <li>• Open the security settings screen for Internet Explorer, and select [Internet]. Click the [Custom level] button, set [Allow script-initiated windows without size or position constraints] to [Enable] under [Miscellaneous], and click the [OK] button. When the warning window appears, click the [Yes] button.</li> </ul>	---
The IP images do not match the display frames	<ul style="list-style-type: none"> <li>• <b>Images may not appear correctly if their DPI settings are 120 DPI or higher.</b> → Right-click on the desktop of the personal computer, click [Display settings] - [Change the size of text, apps, and other items], and select [100% (Recommended)].</li> </ul>	---
	<ul style="list-style-type: none"> <li>• <b>Images may not appear correctly if the magnification level of Internet Explorer's zoom function is not set to 100%.</b> → Select [View] - [Zoom] in the menu bar of Internet Explorer, and click [100%].</li> </ul>	---
The layout of the screen is distorted, or some buttons on the screen do not operate	<ul style="list-style-type: none"> <li>• Select [Tools] - [Compatibility View Settings] in the menu bar of Internet Explorer, disable compatibility view for the unit.</li> </ul>	---

# Specifications

## Power requirements:

12 V DC === (10.8 V to 13.2 V)  
42 V to 57 V DC === (PoE++ power supply)

## Current consumption:

5.0 A (XLR connector input)  
1.5 A (PoE++ power supply)

 indicates safety information.

## GENERAL

### Ambient operating temperature:

0 °C to 40 °C (32 °F to 104 °F)

### Storage temperature:

-20 °C to 50 °C (-4 °F to 122 °F)

### Ambient operating humidity:

20% to 90% (no condensation)

### Mass:

Approx. 4.6 kg (10.12 lb) (excluding mount bracket)

### Dimensions (W × H × D):

213.0 mm×277.0 mm×240.0 mm  
(8-3/8 inches × 10-29/32 inches × 9-7/16 inches)  
(excluding protrusions, mount bracket)

### Finish:

AW-UE160WP/AW-UE160WPC/AW-UE160WE/  
AW-UE160WED: Pearl white  
AW-UE160KP/AW-UE160KPC/AW-UE160KE/  
AW-UE160KED: Black

### Controller supported:

AW-RP150, AW-RP60, AK-HRP1010, AK-HRP1015,  
AK-HRP250

## INPUT

### Input connector

#### DC IN 12 V

G/L IN: BBS (Black Burst Sync), tri-level sync supported

#### AUDIO INPUT1/2:

Supports microphone or line input (SDI/HDMI/IP)  
AAC compatible (compatible with IP only)  
XLR×2, 3-pin, female  
Balanced input 2ch

- Microphone gain during microphone input:  
60 dB or 40 dB  
Supports phantom power,  
Plug-in power compatible, supply voltage:  
47 V ±2 V  
Input impedance: Approx. 10 kΩ
- During LINE input  
Input level: 0 dBu or +4 dBu  
Input impedance: Approx. 10 kΩ
- Input volume variable range:  
-40 dB to 0 dB to +20 dB (1 dB step)
- Embedded audio output level:  
-12 dBFS/-18 dBFS/-20 dBFS
- Sampling frequency:  
48 kHz
- Quantization bit rate:  
24bit (SDI, HDMI), 16bit (IP)

## OUTPUT

### Video output

#### HDMI:

HDMI 2.0 connector  
4:2:2/10bit  
• HDCP is not supported.  
• Viera Link is not supported.

#### 12G SDI OUT:

SMPTE2082-1 / SMPTE424M / SMPTE292M /  
75 Ω (BNC×1)  
• Level-A/Level-B supported

#### 3G SDI OUT1:

SMPTE424M / SMPTE292M /75 Ω (BNC×1)  
• Level-A/Level-B supported

#### 3G SDI OUT2/PM:

SMPTE424M / SMPTE292M /75 Ω (BNC×1)  
• Level-A/Level-B supported

#### SFP+:

Conforms with SFP+ (Single Fiber)  
• Does not support optical signal input

#### USB:

USB3.0 HOST 5G mobile router (supports USB  
tethering)

## INPUT/OUTPUT

### Input/Output connector

#### LAN:

RJ-45  
LAN terminal for IP control and video transmission  
PoE++ power terminal (IEEE802.3bt compliant)

#### RS-422:

CONTROL IN RS-422A (RJ-45)

#### SFP+(SMPTE ST2110):

Supported standards:  
• SMPTE ST2110-10/-20/-21/-30  
• PTP SMPTE ST2059-2  
• NMOS IS-04/IS-05  
Number of outputs:  
Video×3 (main line, Crop, Monitor), audio×2  
Number of inputs: Video×1 (RETURN)  
Video formats: FHD  
• Conforms with system format

## FUNCTIONS AND PERFORMANCE

### [Camera unit]

Imaging sensors: 1.0-type 4K MOS×1

#### Lens:

Motorized Optical 20× zoom, F2.8 to F4.5  
[f=8.8 mm (11/32 inches) to 176 mm  
(6-15/16 inches); 35 mm (1-3/8 inches)  
equivalent: 24.5 mm (31/32 inches) to 490.0 mm  
(19-9/32 inches)]  
i.Zoom (UHD: 24×, FHD: 32×)  
• 20× optical zoom, iZoom and Digital Zoom  
switching  
D.Extender (1.4×, 2×)

#### Angle of view range:

Horizontal angle of view: 75.1° (wide) to 4.0° (tele)  
Vertical angle of view: 46.7° (wide) to 2.3° (tele)  
Diagonal angle of view: 82.8° (wide) to 4.6° (tele)

#### Optical filter:

Through, 1/4, 1/16, 1/64, IR through  
• Equipped with Low pass filter  
(IR through is used as "Night mode")

## Specifications (continued)

<b>Focus:</b>	Switching between auto and manual	<b>White balance:</b>	ATW, 3200K, 5600K AWB: AWB-A/AWB-B VAR (selectable between 2000K and 15000K by designating a value) <ul style="list-style-type: none"><li>• ATW Speed variable in 3 steps</li></ul>
<b>Focus distance:</b>	Entire zooming range: 1000 mm (3.3 ft) Wide end: 100 mm (0.33 ft)	<b>Chroma amount variability:</b>	OFF, -100% to 40%
<b>Color separation optical system:</b>	1MOS	<b>Scene file:</b>	Scene1 to 8
<b>Standard sensitivity:</b>	F11/2000 lx (When [Shooting Mode] is [Normal]) F14/2000 lx (When [Shooting Mode] is [Low Light])	<b>Color bar:</b>	SMPTE, FULL ARIB (FHD): Output of base band type only ARIB (UHD): Output of base band type UHD only ARIB (2020/HLG): Output of base band type UHD only <ul style="list-style-type: none"><li>• IP display color bars do not conform with SMPTE.</li></ul>
<b>Horizontal resolution:</b>	1600 TV lines Type (Center area, in UHD Mode, at the Wide end)	<b>Output format</b>	
<b>Gain selection:</b>	Auto, 0 dB to 12 dB (1 dB steps)	<b>UHD/FHD SDI output:</b>	
<b>Frame mix:</b>	Auto, 0 dB, 6 dB, 12 dB, 18 dB, 24 dB <ul style="list-style-type: none"><li>• This cannot be configured when the format is 2160/29.97p, 2160/23.98p, 2160/24p, 2160/25p, 1080/29.97p, 1080/25p.</li></ul>	<b>[4K format]</b>	2160/60p, 2160/59.94p, 2160/50p, 2160/29.97p*1, 2160/25p*1, 2160/24p*1, 2160/23.98p*1
<b>Electronic shutter speed:</b>	<ul style="list-style-type: none"><li>• 60p mode 1/100, 1/120, 1/125, 1/250, 1/500, 1/1000, 1/1500, 1/2000</li><li>• 59.94p/59.94i mode 1/100, 1/120, 1/125, 1/250, 1/500, 1/1000, 1/1500, 1/2000</li><li>• 50p/50i mode 1/60, 1/100, 1/125, 1/250, 1/500, 1/1000, 1/1500, 1/2000</li><li>• 29.97p mode 1/48, 1/50, 1/60, 1/96, 1/100, 1/120, 1/125, 1/250, 1/500, 1/1000, 1/1500, 1/2000</li><li>• 25p mode 1/48, 1/50, 1/60, 1/96, 1/100, 1/125, 1/250, 1/500, 1/1000, 1/1500, 1/2000</li><li>• 23.98p mode 1/48, 1/50, 1/60, 1/96, 1/100, 1/120, 1/125, 1/250, 1/500, 1/1000, 1/1500, 1/2000</li><li>• 119.88p mode 1/125, 1/250, 1/500, 1/1000, 1/1500, 1/2000</li><li>• 100p mode 1/125, 1/250, 1/500, 1/1000, 1/1500, 1/2000</li></ul>	<b>[HD format]</b>	1080/119.88p, 1080/100p, 1080/60p, 1080/59.94p, 1080/50p, 1080/29.97p*1, 1080/25p*1, 1080/24p*1, 1080/23.98p*1, 1080/50i, 720/59.94p, 720/50p <ul style="list-style-type: none"><li>• 1080/119.88p and 1080/100p use the 2 3G/SDI OUTPUT1/2 systems.</li><li>• There is no output from 12G/SDI.</li></ul>
<b>Synchro scan:</b>	<ul style="list-style-type: none"><li>• 60p mode 60.0 Hz to 7200 Hz</li><li>• 59.94p/59.94i mode 60.0 Hz to 7200 Hz</li><li>• 50p/50i mode 50.0 Hz to 7200 Hz</li><li>• 29.97p mode 30.0 Hz to 7200 Hz</li><li>• 25p mode 25.0 Hz to 7200 Hz</li><li>• 23.98p mode 24.0 Hz to 7200 Hz</li><li>• 119.88p mode 120.1 Hz to 7200 Hz</li><li>• 100p mode 100.1 Hz to 7200 Hz</li></ul>	<b>HDMI output:</b>	
<b>Gamma:</b>	HD / NORMAL / CINEMA1 / CINEMA2 <ul style="list-style-type: none"><li>• HLG set with separate menu MASTER GAMMA (0.15 to 0.75) R GAMMA (-75 to +75) B GAMMA (-75 to +75)</li></ul>	<b>[4K format]</b>	2160/60p, 2160/59.94p, 2160/50p, 2160/29.97p*1, 2160/25p*1, 2160/24p*1, 2160/23.98p*1
		<b>[HD format]</b>	1080/119.88p, 1080/100p, 1080/60p, 1080/59.94p, 1080/50p, 1080/59.94i, 1080/50i, 1080/29.97p*1, 1080/25p*1, 1080/24p*1, 1080/23.98p*1, 720/59.94p, 720/50p
		<b>Fiber (video only):</b>	
		<b>[4K format]</b>	2160/60p, 2160/59.94p, 2160/50p, 2160/29.97p*1, 2160/25p*1, 2160/24p*1, 2160/23.98p*1
		<b>[HD format]</b>	1080/60p, 1080/59.94p, 1080/50p, 1080/29.97p*1, 1080/25p*1, 1080/24p*1, 1080/23.98p*1, 1080/59.94i, 1080/50i, 720/59.94p, 720/50p
		<b>SMPTE ST2110:</b>	
		<b>[HD format]</b>	1080/60p, 1080/59.94p, 1080/50p, 1080/29.97p*1, 1080/25p*1, 1080/24p*1, 1080/23.98p*1, 720/59.94p, 720/50p
		*1 Native output	
		<b>Synchronization system:</b>	Internal/External synchronization (BBS/Tri-level sync)
		<b>[Pan-tilt head unit]</b>	
		<b>Installation method:</b>	Stand-alone (Desktop) or suspended (Hanging) <ul style="list-style-type: none"><li>• To ensure safety, the unit must be secured using the mount bracket supplied.</li></ul>

## Specifications (continued)

---

### Camera/pan-tilt head control:

<b>IP connecting cable</b>	<ul style="list-style-type: none"><li>• When there is a PoE++ Ethernet hub LAN cable*<sup>1</sup> (category 5e or above, straight cable), max. 100 m (328 ft)</li><li>• When there is no PoE++ Ethernet hub LAN cable*<sup>1</sup> (category 5e or above, straight cable), max. 100 m (328 ft)</li></ul>
<b>AW protocol connecting cable</b>	LAN cable* <sup>1</sup> (category 5e or above, straight cable), max. 1000 m (3280 ft)

\*<sup>1</sup> Use of an STP (shielded twisted pair) cable is recommended.

- Use category 6 or better for 4K video transmissions.

### Pan/tilt operation speed:

Speed range: 0.08°/s to 180°/s (During manual operation)

- 3 speed modes installed

Normal: 60°/s, Fast1: 90°/s, Fast2: 180°/s

- Note that the operating noise may be loud in high speed.
- If the operating noise is disturbing, use the Normal mode.

**Panning range:** ±175°

**Tilting range:** -30° to 210°

- Depending on the pan or tilt position, the camera may be reflected in the image.

**Quietness:** NC35 or less

- NC25 or less with P/T pause

# Index

## Numerics

×1.0 button	193
3G SDI	53, 54, 55, 120, 121, 122
3G SDI1 OUT	72, 159
3G SDI Out1	121
3G SDI OUT1	53
3G SDI Out2/PM	122
3G SDI OUT2/PM	54
3G SDI OUT connector	20
12G SDI OUT connector	19
12G SDI Out/SFP+	120
12G SDI OUT/SFP+	52
802.1X	177
3200K	45
5600K	45

## A

Access level	167, 168
Accessories	14
ACH	147
Activation	188
Add host	168
Address(IPv4)	133, 134
Add user	167
Adjust	159
Advanced	172
AF Sensitivity	157
AF SENSITIVITY	69
AGC	58, 143
AGC MAX GAIN	58, 143
ATW	45, 58, 59, 145
ATW Speed	145
ATW SPEED	59
ATW TARGET B	59, 145
ATW TARGET R	59, 145
Audio	140
AUDIO	48, 56
Audio bit rate	141
AUDIO IN connector	20
Audio Level Meter display button	109
Audio over IP	140, 141
Audio over ST2110	140, 141
Audio transmission	141
Authentication	167, 175
Auto	118
AUTO	58
AUTO IRIS	58, 59, 143
AUTO IRIS CLOSE LIMIT	59, 143
AUTO KNEE RESPONSE	63, 152
Automatic installation of viewer software	119
AUTO SHUTTER	58, 60, 144
AUTO SHUTTER LIMIT	60, 144
Auto tracking white adjustment	45
AWB	44

## B

Backup	189
Bar	114
BAR	49, 114
BAR ID	50, 116
Basic Config	112
BASIC CONFIG	48
BAUD RATE	49, 114
B BLACK GAMMA	62, 148, 151
BCH	147
B FLARE	62, 147
B GAIN	147
B GAIN ACH	61, 146, 147
B GAIN BCH	61, 146, 147
B GAMMA	62, 151
Black balance	46
BLACK GAMMA	62, 68, 151
BLACK GAMMA RANGE	62, 151
BLACK GAMMA SW	148

Black level	46
BLACK OFFSET	68, 148
B_MG PHASE	67
B_MG SAT	67
B PEDESTAL	60, 146
B PHASE	67
BRIGHTNESS	50, 116, 142
B SAT	67
Button for displaying the operation menu for the live screen	193
Button for displaying the Paint operation screen for touch panels	190
Button for displaying the Preset operation screen for touch panels	190
Button for displaying the PTZ operation screen for touch panels	190
Button for restoring the screen from the touch panel operation screen	190
Button for switching P/T Speed/Zoom	193
Button for switching PTZ/Focus	193
Button for switching real time updating	109
Button for switching the personal computer screen	109, 193
Buttons for switching the touch panel operation screen	190
B WHITE CLIP LEVEL	63, 152

## C

CA Certificate	
CA Certificate install	174, 182
Generate Certificate Signing Request	174, 181
Information	174
CA Certificate install	178
Camera Control	192
Camera control/Setup Menu button	142
Camera head	18
Camera ID	164
CAMERA ID	71
Camera menu	48, 84
Camera title	119
Camera title display area	108
CBR/VBR	128, 130
CH1 Volume Level	141
CH1 VOLUME LEVEL	57
CH2 Volume Level	141
CH2 VOLUME LEVEL	57
CHAR	54, 55, 56, 58, 120, 121, 122, 123, 124
CHROMA	60, 64, 146, 154
CHROMA LEVEL	60, 64, 146, 154
CHROMA LEVEL SW	60, 64
CHROMA LEVEL SWITCH	146, 154
CH Select	141
CH SELECT	57
Client	165
Client(Caller) port	131
Client certificate install	178
Client certificate type	178
CLIP(-)	154, 155
CLIP(+)	154, 155
Cloud URL	166
Color bar	105
Color Bar Type	114
COLOR BAR TYPE	49
COLOR CORRECT	66, 68, 149
COLOR CORRECTION	66, 150
COLOR CORRECT TABLE	66, 149
COLOR TEMP ACH	61, 146
COLOR TEMP ACH/BCH	61, 67, 146
COLOR TEMP BCH	61, 146
COLOR TEMP SETTING	61, 67
COLOR TEMP SETTING / V-LOG COLOR TEMP SETTING	146
Common	171
Common setup	131
Compression	105
Config data type	189
CONNECT	82
Connection	174, 183
Connection type	164
Contact	176
Control Area	193
Control pad and its buttons	108



## Index (continued)

CRISP .....	64, 153, 154
CROP .....	48, 72
Crop Adjust .....	160
CROP ADJUST .....	73
Crop AF .....	158
CROP AF .....	72
CROP H POSITION .....	73
Crop Marker .....	159
CROP MARKER .....	73
Crop Mode .....	158
CROP OUT .....	73
Crop Output PTZ .....	158
Crop Output Select .....	159
Crop video .....	137
Crop video TX .....	135
CROP VIDEO TX .....	58
CROP V POSITION .....	73
Crop Zoom .....	159
CROP ZOOM .....	72
CROP ZOOM RATIO .....	73
CRT key generate .....	173, 180
CY_B PHASE .....	67
CY_B SAT .....	67
CY PHASE .....	66
CY SAT .....	66

## D

DARK DETAIL .....	64, 65, 154, 155
DARK DETAIL SW .....	64, 65
DARK DETAIL SWITCH .....	154, 155
Date & Time .....	186
Date/Time .....	118
Date&Time .....	118
DATE/TIME .....	81
DAY/NIGHT .....	58, 143
DC IN connector .....	19
Default gateway .....	169, 170, 171
DEFAULT GATEWAY .....	51, 52
Delete host .....	168
Delete user .....	167
Description .....	186
Destination Address .....	136, 137, 138
Destination IP address(IPv4) .....	131
Destination port .....	131
Destination Port .....	136, 137, 138
DETAIL .....	64, 68, 153, 154
DETAIL CLIP(-) .....	64
DETAIL CLIP(+) .....	64
DETAIL GAIN(-) .....	64
DETAIL GAIN(+) .....	64
DETAIL KNEE .....	64, 65, 154, 155
DETAIL SETTING .....	64, 153, 154
DHCP .....	51, 169, 170
DHCPv6 .....	170, 171
Digital Extender .....	158
DIGITAL EXTENDER .....	69
DNR .....	67
DNR LEVEL .....	67, 147
DNR SW .....	147
DNR / V-LOG DNR .....	147
DNS .....	52, 171
Domain .....	171
DOWNCON SETTING .....	64, 154
Download .....	189
Drop-prevention wire .....	18
DRS .....	63, 68, 152

## E

EAP authentication method .....	177
Easy IP Setup accommodate period .....	172
Easy IP Setup Tool Plus .....	178
EasyIP Setup Tool Plus .....	33
EFFECT DEPTH .....	63, 152
Encryption .....	132
Encryption method .....	175

Error code .....	186
Error description .....	186
Error log .....	186
ERROR STATUS .....	82
Event code .....	186
Event log .....	186
EXECUTE .....	81
Expansion panel display button .....	104
External Output .....	115
EXTERNAL OUTPUT .....	49
External sync signal input format .....	20

## F

Fall Acceleration .....	118, 162
FALL ACCELERATION .....	75, 77
Fall Ramp Time .....	162
FALL RAMP TIME .....	77
Fall S-Curve .....	117, 162
FALL S-CURVE .....	75, 77
Fan1 .....	187
FAN1 .....	81, 82
Fan2 .....	187
FAN2 .....	81, 82
FAN SETTING .....	81
FILE NAME .....	81
FILE NO .....	81
FILES .....	48, 81
Firmware file .....	188
Firmware version .....	188
Firmware Version .....	112
FLARE .....	62, 68, 147
Flip Detect Angle .....	117
FLIP DETECT ANGLE .....	74
Focus .....	42, 107
Focus Adjust With PTZ .....	118
FOCUS ADJUST WITH PTZ .....	75
Focus (AUTO)/Iris (AUTO) button .....	193
Focus Mode .....	157
FOCUS MODE .....	69
Format .....	51, 112, 113, 134, 136, 137, 138
FORMAT .....	48, 58, 82, 124
Format Select .....	120, 121, 122, 123
FORMAT SELECT .....	52, 53, 54, 55, 57
FRAME MIX .....	58, 143
FRAME MIX SW .....	58, 143
Frame rate .....	128, 130
Freeze During Preset .....	163
FREEZE DURING PRESET .....	78
Frequency .....	50, 112
FREQUENCY .....	48
Full-screen display button .....	108

## G

G .....	49, 115
Gain .....	42, 108
GAIN .....	58, 68, 143, 148
GAIN(-) .....	153
GAIN(+) .....	153
GAIN OFFSET ACH .....	61, 147
GAIN OFFSET BCH .....	61, 147
GAIN SETTING .....	58, 143
Gamma .....	151
GAMMA .....	62, 68
GAMMA/BLACK GAMMA .....	62, 68, 148, 151
GAMMA/KNEE .....	151
GAMMA MODE SELECT .....	62, 151
GAMUT .....	49, 114
G AXIS ACH .....	61, 146
G AXIS BCH .....	61, 146
G_CY PHASE .....	66
G_CY SAT .....	66
Genlock .....	47
GEN-LOCK .....	50
GENLOCK .....	115
G FLARE .....	62, 147

## Index (continued)

G GAIN	147
G GAIN ACH	61, 147
G GAIN BCH	61, 147
G GAIN REL CONTROL SW	61
G GAIN REL CONTROL SWITCH	147
G/L IN connector	20
G PEDESTAL	60, 146
G PHASE	66
Ground connector	20
Grounding	8
Group	134, 135
G SAT	66

## H

H	160
H.264	125, 127
H.264 transmission	127
H.265	125, 129
H.265 transmission	129
H DETAIL LEVEL	64, 154
HDMI	55, 123
HDMI connector	19
HDMI STATUS	82
HDR	48, 113
HDR OUTPUT SELECT	52, 53, 55, 120, 121, 122, 123
HDR PAINT	68, 148
Head Room	141
HEAD ROOM	57
HI COLOR	152
HI-COLOR	63
HI COLOR LEVEL	152
HI-COLOR LEVEL	63
High bandwidth NDI	134
HLG MODE	68, 148
Hole for securing the camera pedestal	18
Home button	193
Horizontal phase adjustment	47
Host auth.	168
Host IP address	168
HOUR METER	82
HTTP max segment size (MSS)	172
HTTP port	171
HTTP PORT	52
HTTPS	173, 179, 183
HTTPS mode	174
HTTPS port	174
HTTPS PORT	52

## I

I CENTER	65, 155, 156
ID1	50, 116
ID1 POSITION H	50, 116
ID1 POSITION V	50, 116
ID2	50, 116
ID2 POSITION H	50, 116
ID2 POSITION V	50, 116
Image/Audio	125
Image capture size	126, 128, 129
Image quality	127
INDEX NO.	49
Index number	176
Initial account	34, 102
Initial display setting	125, 126
INITIAL GAMMA	62, 151
INITIALIZE	81
INPUT1	57
Input1 audio	137
Input1 audio TX	135, 141
Input1 Setting	140
INPUT1 SETTING	56
INPUT2	57
Input2 audio	137
Input2 audio TX	135, 141
Input2 Setting	140
INPUT2 SETTING	56

Input Select	140, 141
INPUT SELECT	56
Input Setting 1	140
Input Setting 2	141
Install Position	117
INSTALL POSITION	74
Internet mode(Over HTTP)	127
Invert Pan/Tilt Axis	165
INVERT PAN/TILT AXIS	71
IP	71
IP address	168
IP ADDRESS	51
IP address(IPv4)	165, 169, 170, 171
IP address(IPv6)	170, 171
IP(H.264/H.265)	57, 124
IP(H.264/H.265) OUT1	73
IP(H.264/H.265) OUT2	73
IP image output 1	24
IP out	165
IP OUT1 (H.264/H.265)	159
IP OUT2 (H.264/H.265)	159
IP SIGNAL	48, 57, 124
IP(UDP)	165
IPv4 network	169, 170
IPv6 network	170, 171
Iris	42, 108
IRIS	59, 143
IRIS SPEED	59, 143, 144
IS-04 Port	139
IS-05 Port	139
I WIDTH	65, 155, 156

## J

JPEG	125, 126
JPEG transmission	126

## K

Kairos Cloud	166
KNEE	63, 68, 148, 152
KNEE APERTURE LEVEL	64, 154, 155
KNEE B POINT	63, 152
KNEE B SLOPE	63, 152
KNEE MASTER POINT	63, 152
KNEE MASTER SLOPE	63, 152
KNEE MODE	58, 63, 152
KNEE POINT	68, 148
KNEE R POINT	63, 152
KNEE R SLOPE	63, 152
KNEE SLOPE	68, 148
KNEE SW	148

## L

Label prefix	139
Label setting	139
LAN	51, 169
LAN connector for IP control	18
Latency	131
Lens	157
LENS	48, 69, 82
LEVEL DEPENDENT	64, 65, 154, 155
LEVEL DEPENDENT SW	64, 65
LEVEL DEPRENDED SWITCH	154, 155
LEVEL GAUGE	70, 157
Level Gauge switching button	109
Limitation Setting	161
Limiters	194, 195
LINEAR MATRIX	66, 68, 149
LINEAR TABLE	66, 149
Line Level	140, 141
LINE LEVEL	56
Linkage	164
LIST	81
Live	103, 104, 106
Live page	119
Location	176

## Index (continued)

Lock ..... 106

### M

MAC ADDRESS ..... 51  
MAC address(LAN) ..... 188  
MAC address(SFP+) ..... 188  
Main area ..... 106  
Maintenance ..... 186, 187  
MAINTENANCE ..... 48, 81  
Main video ..... 136  
Main video TX ..... 135  
MAIN VIDEO TX ..... 58  
Manual ..... 118, 170, 171  
Manual shooting ..... 42  
MASTER BLACK GAMMA ..... 62, 148, 151  
MASTER DETAIL ..... 64, 153, 154  
MASTER FLARE ..... 62, 147  
MASTER GAMMA ..... 62, 151  
Master pedestal ..... 46  
MASTER PEDESTAL ..... 60, 146  
MASTER WHITE CLIP LEVEL ..... 63, 152  
MATRIX ..... 66, 68, 149  
MATRIX (B-G)\_N ..... 66  
MATRIX (B-G)\_P ..... 66  
MATRIX (B-R)\_N ..... 66  
MATRIX (B-R)\_P ..... 66  
MATRIX (G-B)\_N ..... 66  
MATRIX (G-B)\_P ..... 66  
MATRIX (G-R)\_N ..... 66  
MATRIX (G-R)\_P ..... 66  
MATRIX (R-B)\_N ..... 66  
MATRIX (R-B)\_P ..... 66  
MATRIX (R-G)\_N ..... 66  
MATRIX (R-G)\_P ..... 66  
Max bit rate(per client) ..... 128, 130  
Max Digital Zoom ..... 157  
MAX DIGITAL ZOOM ..... 69  
Max RTP packet size ..... 172  
mDNS ..... 177  
Media over IP ..... 135  
MEMORY SELECT ..... 65, 155, 156  
Metric ..... 170, 171  
MG\_PHASE ..... 67  
MG\_R PHASE ..... 67  
MG\_R SAT ..... 67  
MG\_SAT ..... 67  
Mic Gain ..... 140, 141  
MIC GAIN ..... 56  
Mode ..... 117, 125, 131, 156, 166, 167, 168  
MODE ..... 70, 81  
Model no. .... 112, 188  
MOIP MODE ..... 58  
MONITOR ..... 82  
Monitor Display ..... 156  
MONITOR DISPLAY ..... 48, 70  
Monitor video ..... 137  
Monitor video TX ..... 135  
MONITOR VIDEO TX ..... 58  
Mount bracket for installation surface ..... 18  
MPEG2-TS over UDP ..... 132  
Multicast address ..... 128, 130  
Multicast address(IPv4) ..... 132  
Multicast port ..... 129, 130  
Multicast Port ..... 132  
Multicast Transmit ..... 133, 134  
Multicast TTL/HOPLimit ..... 129, 130, 132

### N

Name ..... 134, 135  
ND ..... 109  
ND Filter ..... 158  
ND FILTER ..... 69  
NDI ..... 57, 124  
NDI|HX V2 ..... 133  
NDI|HX V2/NDI|HX V2(UHD) ..... 133

NDI Out ..... 159  
NDI OUT ..... 72  
Network ..... 169  
NETWORK ..... 48, 51  
NMOS ..... 135, 139  
NMOS control ..... 139  
NMOS Master Enable ..... 135  
No. .... 186  
NTP ..... 118, 172  
NTP port ..... 173  
NTP server address ..... 173  
NTP server address setting ..... 173

### O

OFFSET H ..... 50, 116  
OFFSET V ..... 50, 116  
O.I.S. .... 69  
O.I.S. Mode ..... 69, 158  
OPERATION ..... 82  
Operation screen display buttons ..... 104  
Operation time ..... 186, 188  
Optional accessories ..... 14  
OSD Menu ..... 105  
OSS license display ..... 188  
Other Menu ..... 105  
Output ..... 119  
OUTPUT ..... 48, 52  
Output1 ..... 115  
OUTPUT1 ..... 49  
Output2 ..... 115  
OUTPUT2 ..... 49  
Output client select ..... 165  
Output Item ..... 120, 121, 122, 124  
OUTPUT ITEM ..... 53, 54, 55, 57  
OUTPUT SELECT ..... 54, 122  
Output Setting ..... 140, 141  
OUTPUT SETTING ..... 57

### P

Paint ..... 142  
PAINT ..... 48, 58  
Paint operation area for touch panels ..... 191  
PAINT SWITCH ..... 68  
Pan/Tilt ..... 117  
PAN/TILT ..... 48, 74, 82  
Pan/Tilt Lens Control ..... 161  
Passphrase ..... 132  
Password ..... 166, 167, 175, 178  
PC Synchronization ..... 118  
PEAK FREQUENCY ..... 64, 153, 154  
PEAK RATIO ..... 59, 143  
PEAP ..... 178  
PEDESTAL ..... 60, 146  
PEDESTAL OFFSET ..... 60, 146  
PICTURE ..... 144  
PICTURE LEVEL ..... 59, 143  
Plain text usage ..... 178  
Plug-in viewer software ..... 35  
POINT ..... 68, 148  
Port ..... 166  
PORT ..... 49  
Position ..... 156  
POSITION ..... 70  
Power ..... 37  
Power ON ..... 106  
Power On Position ..... 118  
POWER ON POSITION ..... 75  
Preset ..... 108, 161  
PRESET ..... 48, 77  
Preset Acceleration ..... 162  
PRESET ACCELERATION SETTING ..... 77  
Preset Crop ..... 163  
PRESET CROP ..... 78  
Preset Digital Extender ..... 163  
PRESET DIGITAL EXTENDER ..... 78

## Index (continued)

Preset Iris	163
PRESET IRIS	78
PRESET MATRIX	66, 149
Preset memory	43
Preset Name	163
PRESET NAME	78
Preset Number	118
PRESET NUMBER	75
Preset operation area for touch panels	191
Preset position	160
Preset Scope	163
PRESET SCOPE	77
Preset Setting	162
Preset Shutter	163
PRESET SHUTTER	78
Preset Speed	162
PRESET SPEED	77
Preset Speed Table	162
PRESET SPEED TABLE	77
Preset Speed Unit	162
PRESET SPEED UNIT	77
Preset thumbnail list display button	109
Preset thumbnail operation area	193
Preset Thumbnail Update	163
PRESET THUMBNAIL UPDATE	78
Preset Zoom Mode	163
PRESET ZOOM MODE	78
Primary server address	171
Privacy Mode	118
PRIVACY MODE	75
Private Key password	178
Private Key password usage	178
Product info.	188
Profile type	127
Protocol	133, 134
P/T Acceleration	117
P/T ACCELERATION	74
P/T Acceleration Setting	117
P/T ACCELERATION SETTING	74
PTP	135, 138
P/T Speed Mode	117
P/T SPEED MODE	74
P/T Speed/Zoom operation area	193
PTZ/Focus operation area	193
PTZ operation area for touch panels	190
Push UDP	132

## Q

Q PHASE	65, 155, 156
Q WIDTH	65, 155, 156

## R

R	49, 115
R BLACK GAMMA	62, 148, 151
Reboot	187
Recommended Kairos Cloud Platform Setting	166
Referrer check	176
Refresh interval	127
REF SIGNAL	50, 115
Remote control IDs	32
Reset to the default (Except the network settings)	187
Return	123
RETURN	48, 56
RETURN1 ID	123
RETURN SELECT	70, 156
Return video	138
Return video RX	135
RETURN VIDEO RX	58
Retype password	167
R FLARE	62, 147
R GAIN	147
R GAIN ACH	61, 146, 147
R GAIN BCH	61, 146, 147
R GAMMA	62, 151
RGB GAIN ACH/BCH	61, 147

RGB GAIN CONTROL SETTING	61, 147
RGB GAIN PRESET	61, 147
Rise Acceleration	117, 162
RISE ACCELERATION	75, 77
Rise Ramp Time	162
RISE RAMP TIME	77
Rise S-Curve	117, 162
RISE S-CURVE	74, 77
R PEDESTAL	60, 146
R PHASE	67
RS-422 connector	20
R SAT	67
RTMP	130
RTSP	175
RTSP port	175
RTSP request URL	175
R WHITE CLIP LEVEL	63, 152
R_YE PHASE	67
R_YE SAT	67

## S

Safe mode	196
SCENE	142
SCENE FILE	81
Scene/User	108
SDR CONVERT	68, 148
SDR CONVERT MODE	68, 148
Secondary server address	171
Security certificate	184
Self-signed Certificate	
Generate	173, 180
Information	173
Serial	164
SERIAL	71
SERIAL CONNECTION	49, 114
Serial no.	188
Server address(IPv4)	134, 135
Server setup	130
Service switches	19
Setting status	112, 125, 135, 140, 164, 167, 168
Setup	103, 110
SFP+	51, 170
SFP connector	19
SFP+ Mode	113
SFP+ MODE	48
SHOCKLESS WB SPEED	59
SHOCKLESS WB SW	59, 145
SHOCKLESS WB SW SPEED	145
Shooting	36, 39
SHOOTING MODE	49, 114
Shutter	109
SHUTTER MODE	60, 143
Shutter speed	42
SHUTTER SPEED	60, 143
SHUTTER SW	60, 143
Signal	119
SKIN TONE CRISP	65, 155, 156
SKIN TONE DETAIL	65, 68, 155, 156
SKIN TONE DETAIL SETTING	65, 156
SKIN TONE EFFECT MEMORY	65, 155, 156
SLOPE	68, 148
Smart Picture Flip	117
SMART PICTURE FLIP	74
Smoother live video display on the browser(buffering)	119
Snapshot button	108
Snapshot button for touch panels	190
SNMP	175
Source Address	138
Source name	133, 134
Speed	108
Speed With Zoom Position	118
SPEED WITH ZOOM POSITION	75
SRT	131
SRT/MPEG2-TS/RTMP	109
SRT/MPEG2-TS/RTMP operation area for touch panels	190
ST2110	58, 135, 136

## Index (continued)

ST2110 Audio Format .....	141
ST2110 AUDIO FORMAT .....	57
ST2110 port .....	136
ST2110 RX .....	138
ST2110 TX .....	136
Standby .....	106
Status .....	139
STATUS(AUTO) .....	70, 156
Status display lamp .....	18
Status Indicator .....	156
STATUS INDICATOR .....	70
Status Lamp .....	187
STATUS LAMP .....	83
Stream .....	105, 126
Stream ID .....	131
Streaming format .....	131, 132, 133, 134
Streaming mode .....	112, 125
Stream Menu .....	105
Subnet(IPv4) .....	134, 135
Subnet mask .....	169, 170, 171
SUBNET MASK .....	51
Sync .....	106
Synchronization with NTP .....	172
SYNCHRO SCAN .....	60, 144
SYNC SIGNAL .....	50, 115
System .....	112
System Format .....	112
System Frequency .....	112
System log .....	186
System name .....	176

## T

Tally .....	115
TALLY .....	49, 115
Tally Brightness .....	115
TALLY BRIGHTNESS .....	49
Tally Guard .....	115
TALLY GUARD .....	49
Tally lamp .....	18
Tally LED Limit .....	115
TALLY LED LIMIT .....	49
TEMPERATURE .....	82
Tilt head .....	18
Time adjustment interval .....	173
Timecode Overlay .....	126
Time Zone .....	118
TLS .....	177
TLS User name .....	178
Tone .....	115
TONE .....	49
Top Menu screen .....	48
Tracking data output .....	71
Tracking Data Output .....	164
TRACKING DATA OUTPUT .....	48, 71
Transmission type .....	128, 130, 132
Tripod screw holes .....	21
TSL5.0 .....	49, 176
TSL5.0 Port .....	176
TTL/HOP Limit .....	131, 134, 135

## U

UHD Crop .....	158
UHD CROP .....	72
Unicast address(IPv4) .....	132
Unicast Port .....	132
Unicast port(Audio) .....	128
Unicast port(Image) .....	128
Upload .....	189
URL .....	130
URL type .....	130
USB .....	51, 170
USB3.0 HOST connector .....	19
Use discovery server .....	134, 135
USER .....	142
User auth. ....	167

USER FILE .....	81
User ID .....	166
User mng. ....	167
User name .....	167, 175, 178

## V

V .....	160
VAR .....	45
V DETAIL FREQUENCY .....	64, 154
V DETAIL LEVEL .....	64, 154
Ventilation holes .....	18
VERSION .....	82
Video over IP .....	125
Video Sampling .....	123
VIDEO SAMPLING .....	56, 82
Viewer software installation counter .....	188
V-LOG .....	48, 113
V-LOG OUTPUT SELECT .....	53, 55, 56, 120, 121, 122, 123
V-LOG PAINT .....	67
V-LOG PAINT SW .....	48, 113

## W

Wait time mode .....	167
WB .....	109
W.BAL VAR .....	59, 145
W/B BAL SETTING .....	59, 145
Web screen .....	101
WFM .....	70, 156
White balance .....	44
WHITE BALANCE MODE .....	59, 145
WHITE CLIP .....	63, 68, 152
WHITE SHADING .....	83
WINDOW SELECT .....	59, 143
Wireless Control .....	187
WIRELESS CONTROL .....	83
Wireless ID .....	187
WIRELESS ID .....	32, 83
Wireless remote control .....	17, 31, 32
Wireless remote control signal light-sensing area .....	18

## Y

Y .....	49, 115
YE_G PHASE .....	67
YE_G SAT .....	67
YE PHASE .....	67
YE SAT .....	67

## Z

ZEBRA .....	65, 155, 156
ZEBRA EFFECT MEMORY .....	65, 155, 156
Zoom .....	107
Zoom (Crop Zoom Ratio) .....	159
Zoom Mode .....	157
ZOOM MODE .....	69

**Panasonic Connect Co., Ltd.**

Web Site: <https://pro-av.panasonic.net/en/>

© Panasonic Connect Co., Ltd. 2023