

DK SERIES

DK751DH5

75" 4000 nits 4K UHD Outdoor Ultra-High Brightness Hybrid Kiosk with Light Box

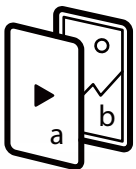

HYBRID
DIGITAL & STATIC

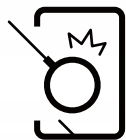

VANDAL
RESISTANT

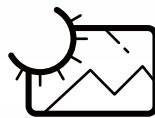

SUNLIGHT
VIEWABLE IMAGE

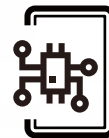

SMART
LIGHT BOX



WEATHER
PROOF

FOR MORE INFORMATION

For more information about DynaScan, visit our website at www.dynascandisplay.com. Copyright © DynaScan Technology Inc. All rights reserved. All specifications and descriptions are subject to change without notice. Reproduction without permission is prohibited.

DynaScan

SPECIFICATION

MODEL	DK751DH5	
DISPLAY	LCD Panel Size	74.52"
	Native Resolution	3840 x 2160
	Brightness (w/o glass)	4,000 nits
	Light Lifetime (Typ.)	100,000 hrs
	Color Depth	10 bits
	Contrast Ratio	3000 : 1
	Response Time (Typ.)	8 ms
	Viewing Angle	178° / 178°
	Polarized Sunglasses Support	Yes
	Touch Function (Optional)	P-Cap touch
POWER	Power Supply	Internal
	Rated Voltage	100-240V ~ 50/60HZ
	Power On Mode (Typ./ Max)	535 W / 1000 W
LIGHT BOX	Bezel Width (T/B/L/R)	89 / 89 / 89 / 89 mm
	Poster Size (WxH)	1200 x 1800 mm
	Kiosk Visual Opening (WxH)	1160 x 1710 mm
MECHANICAL SPECS	Digital Side Bezel Width (T/B/L/R)	117.6 / 117.6 / 203.5 / 203.5 mm
	Cabinet Color	Black
	Dimension (LxHxD, w/o stand)	1338.0 x 1962.0 x 254.0 mm
	Weight	< 350 kg [TBD] (lightbox excluded)
	Orientation	Portrait
	Glass	Yes
	Air Vent	Yes
	Key Lock (Option)	Yes
FEATURE	Language	English
	Support SNMP (Up to V3.0)	Yes
	Dimming Control	Yes
	Image Retention Protection	Yes
	Ambient Light Sensor	Yes
	Power On/Off Scheduling	Yes
INPUT	HDMI	x3 (2160p)
	Display Port	x1
	USB 3.0	x1
	Micro SD Slot	x1
OUTPUT	Audio	x1
EXTERNAL CONTROL	RS-232	In x1
	RJ-45	x2 (LAN)
INTERNAL PLAYER	Operating System	Android 8.0.0
	Processor	Dual-core A73 and dual-core A53
	Clock Speed	1.5GHz
	Main Memory Interface	DDR4, 2G
	Graphics	Quad-core MaliG51
	Storage	Internal: 16GB eMMC Flash External: Support Micro SD , Up to 128GB(FAT32/NTFS)
	Multimedia	4K 10bits VP9/H265/H264 video decoders, up to 60fps 1080P other video decoders (VC-1, MPEG-1/2/4, VP8)
ENVIRONMENT	Operating Temperature	-30° C ~ 50° C
	Storage Temperature	-20° C ~ 60° C
	Humidity	10% ~ 100% RH Non-condensing
	Water and Dust resistant design	IP56
CERTIFICATION	CE / IEC60950-22 / RoHS	

DIMENSIONS

Unit: mm [inch]

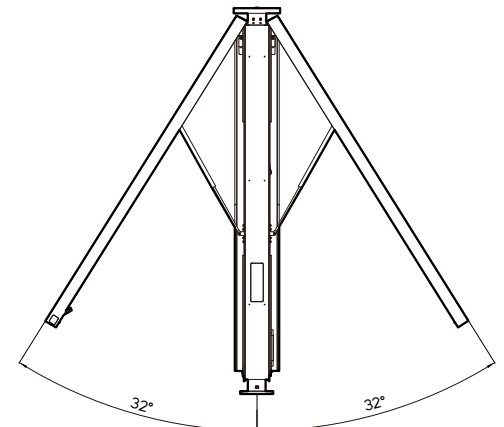
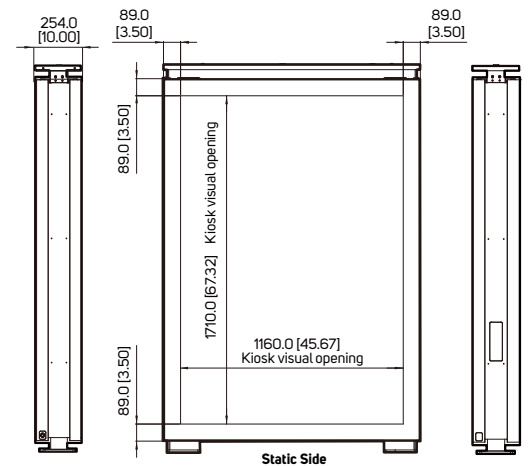
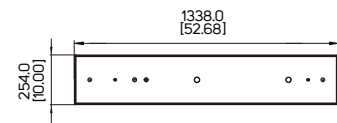
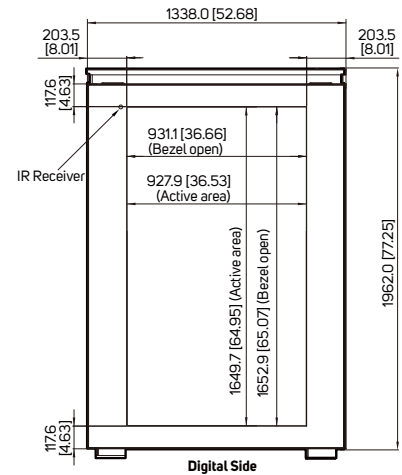

FOR MORE INFORMATION

For more information about DynaScan, visit our website at www.dynascandisplay.com. Copyright © DynaScan Technology Inc. All rights reserved. All specifications and descriptions are subject to change without notice. Reproduction without permission is prohibited.

DynaScan