



TL45, TL46, TL47, TL48

TwinPlex™ Lavalier Microphones

Shure TwinPlex Lavalier online user guide for TL45, TL46, TL47, TL48. Includes how to attach windscreen, clip options, wiring diagrams, and specifications.

Version: 11.2 (2023-B)

Table of Contents

TL45, TL46, TL47, TL48 TwinPlex™ Lavalier Microphones	3	Accessories	8
General Description	3	Replacement Parts	9
Features	3	Furnished Accessories	9
Model Variations	4	Optional Accessories	10
The Shure TwinPlex Cartridge	5	Wiring and Termination	10
Care and Maintenance	5	Typical Wiring Table	10
TwinPlex Accessories Quick Start	5	Converting LEMO to TA4F	11
Frequency Caps	6	TA5F Wiring for Lectrosonics Bodypacks (Servo Biased Wiring)	12
Attaching the Windscreen	6	Hirose Wiring for Sony Bodypacks	13
Lavalier Standoff	7	LEMO Wiring for Q5X Bodypacks	14
Tie Clip	7	MTQG Connector Assembly	15
Dual Tie Clip	7	RPM400 Preamplifiers	15
Vampire Clip	7	Features	15
Sticky Mount	8	Preamplifier Mounting Kit	15
Sticky Vampire Clip	8	Specifications	16
Lavalier Distance	8	Frequency Response	20
Threaded Mount Instructions	8	Certifications	21

TL45, TL46, TL47, TL48 TwinPlex™ Lavalier Microphones

General Description

TWIN:PLEX™



The Shure TwinPlex subminiature omnidirectional lavaliers are designed to perform better than other 5 mm lavalier microphones for professional theater, film, tv, and corporate events. The TwinPlex dual-diaphragm technology yields extraordinary gain-before-feedback, off-axis response, and low self-noise while delivering life-like, exceptional clarity free of digital interference. The cable itself is ultra quiet and has been tested to be the longest-lasting, most dependable cable in its class. The TwinPlex series features the most extensive accessories and connector options to date. TwinPlex 5 mm lavs not only meet premium market-leading expectations, they exceed them.

Note: The regulatory model numbers for these devices are TL46B/O, TL47B/O, and TL48B/O.

Features

- Exceptional sound quality from the all new TwinPlex dual-diaphragm element
 - Robust low frequency response with flat top end
 - Best in class specifications and dynamic range
 - Consistent off axis response results in increased gain before feedback

- Durability beyond the competition
 - Exclusive, double helix cable technology with redundant grounding
 - Nanocoated frequency caps for reduced sweat out
- Comprehensive accessories and microphone offerings
 - Over 60 color, sensitivity, frequency response, and connector options available
 - All new clips, mounts, and accessories designed on extended research and field testing
- High RF immunity for use with today's digital wireless systems.
- Paintable cables allow for discreet placement in professional theater applications.
- Interchangeable frequency response caps offer adjustable flat or presence responses (TL45, TL46, TL47).

Model Variations

Shure TwinPlex lavaliers are available in a variety of connector and sensitivity levels.

Model	Sound	Sensitivity	Connector	Cable Type
TL45 series	Natural	Low	LEMO	1.1mm (Paintable)
TL46 series	Natural	High	LEMO, MTQG	1.6mm (Paintable)
TL47 series	Natural	Low	LEMO, MDOT, MTQG, XLR, NC	1.6mm (Paintable)
TL48 series	Speech	Low	LEMO, MDOT, MTQG, NC	1.6mm (Paintable)

Model Variations Key

TL47 T/O MTQG A
 Series Color Polar Pattern Connector Accessories

Series	Color	Polar Pattern	Connector	Accessories
TL45	B: Black	O: Omnidirectional	LEMO: LEMO3 body-packs	A: Accessories included
TL46	C: Cocoa		MTQG: TA4F/TQG Shure bodypacks	
TL47	T: Tan		XLR: includes XLR pre-amplifier	
TL48	W: White		NC: no connector	
			MDOT: MicroDot (requires adapter)	

Note: Not all model variations are available. Refer to www.shure.com/twinplex for the most up to date offerings.

The Shure TwinPlex Cartridge

Over 6 years in development, the patent pending, TwinPlex Omnidirectional element was designed to offer best in class sound quality and specifications of any lavalier to date. It utilizes a dual-diaphragm design with two side firing elements as opposed to a single, end fired design. By essentially doubling the surface area of the diaphragm in the same amount of space, the TwinPlex design offers robust low frequency response, exceptional off-axis consistency, increased gain-before-feedback and low handling noise, resulting in a new tier of performance for 5mm microphones.

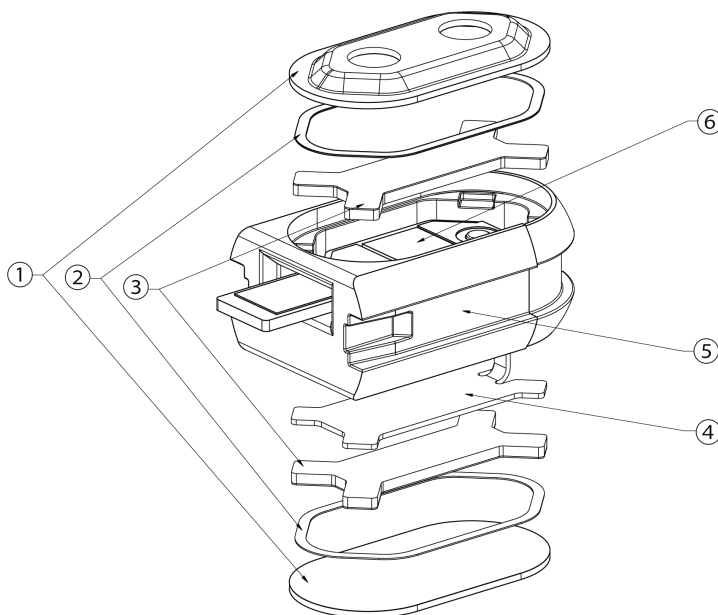

TwinPlex cartridge exploded view

- ① Diaphragm Assembly
- ② Spacer Washer
- ③ Backplate Assembly
- ④ Contact Spacer
- ⑤ Nest
- ⑥ PCB

Care and Maintenance

The TwinPlex lavalier dual-diaphragm has a nanocoating which rejects the build-up of grit from sweat and water. It is designed to withstand being blown out with a can of air for quick clean-up.

TwinPlex Accessories Quick Start

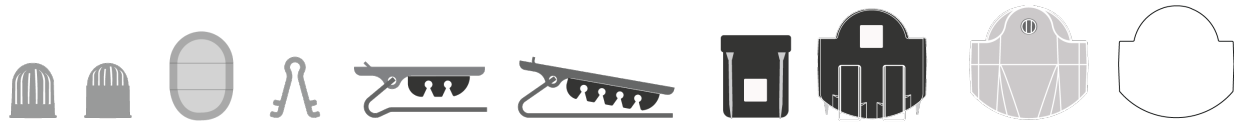

Frequency Caps

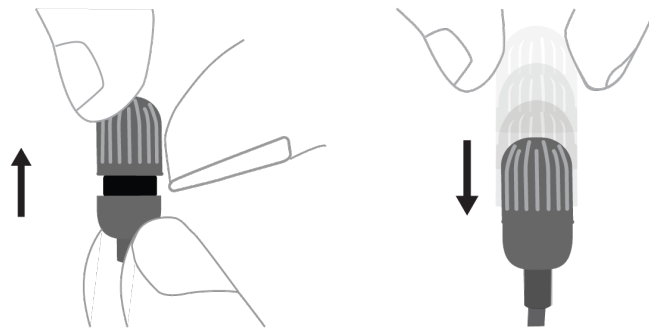

TL45 / TL46 / TL47



TL48

Attaching the Windscreen

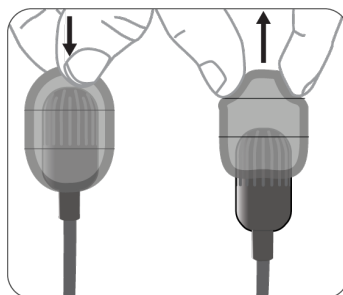

Lavalier Standoff

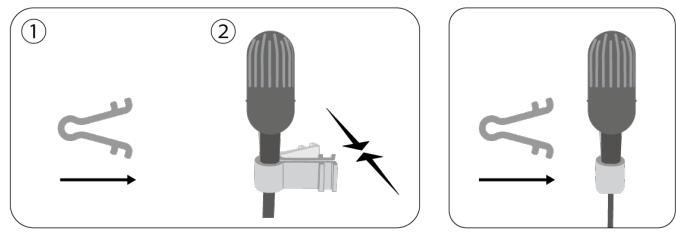

Tie Clip

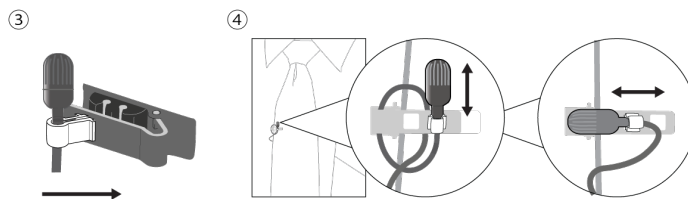

Dual Tie Clip

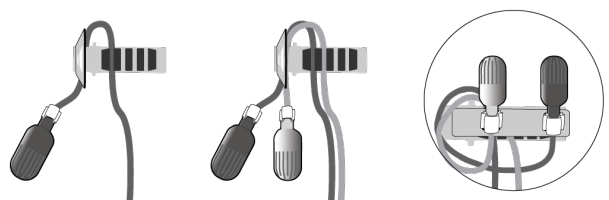

Vampire Clip

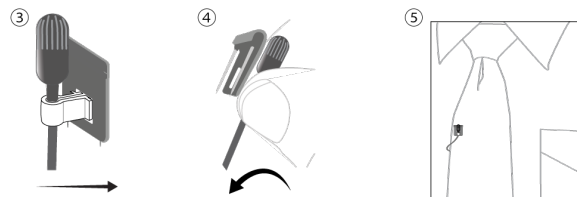

Sticky Mount

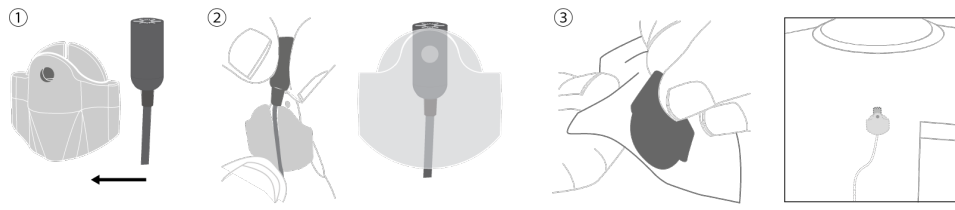

Sticky Vampire Clip

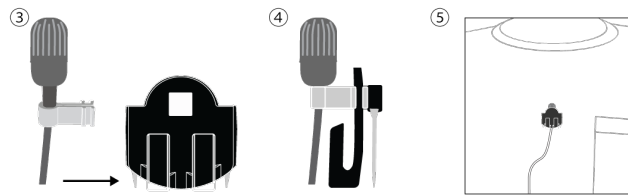

Lavalier Distance

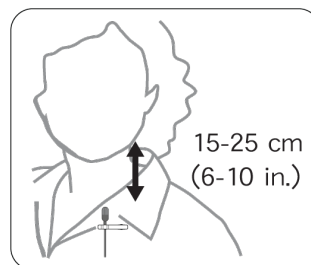

Threaded Mount Instructions

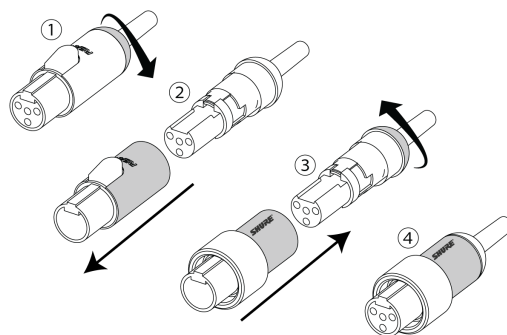

Accessories

Replacement Parts

MTQG/TA4F 4-pin Connector (Shure® Bodypacks)	WA430
Neutrik MTQG 5-pin Connector Kit (Lectrosonics® Bodypacks)	WA435
TL45 Lemo Connector for 1.1mm cables	WA411
TL46/47/48/TH53 Lemo Connector for 1.6mm cables	WA416

MicroDot adapters for -MDOT versions

MicroDot to LEMO 3 Pin for Shure® and Sennheiser® Bodypacks	MD40LEMO
MicroDot to TA4F/TQG for (Shure® Bodypacks)	MD40TA4F
MicroDot to TA5F/TQG (Lectrosonics® Bodypacks)	MD40TA5F

Furnished Accessories

-A Series

Frequency Caps, Flat Response*	RPM40FC
Frequency Caps, Presence Response*	RPM40PC
Single Tie Clip	RPM40STC
Dual Tie Clip	RPM40TC
Standoff for Clips	RPM40SO
Vampire Mount	RPM40VM
Sticky Vampire Mount	RPM40SVM
Foam Windscreen	RPM40WS
Clear Sticky Mount	RPM40SM
Sticky Mount Adhesives (15 Pieces)	RPM40TS
Sticky Mount Adhesives (50 Pieces)	RPM40TS/50
Neutrik Threaded Shell for WA430/WA435	WA445
Storage Case	RPM40CASE

*Not furnished with TL48

Accessories are available in Black (/B), Tan (/T), Cocoa (/C), White (/W), and Mixed (/M) color varieties. Please consult your Shure representative for available options.

-XLR Series

TA4F/TQG XLR Preamplifier	RPM400TQG
Lemo XLR Preamplifier	RPM400LEMO
Belt Clip for XLR Preamplifier	RPM40PRECLIP
Mounting Kit for XLR Preamplifier	RPM40PREMNT

Optional Accessories

Magnet Mount	RPM40MM
Rycote® Mini-WindJammer (Gray)	RPM40MWJ
Accessory Kit for TL Microphones	RPM40KIT

Magnet Mount is available in Black (/B) and White (/W) options.

Note: Optional accessories are not furnished with -A models.

Wiring and Termination

Typical Wiring Table

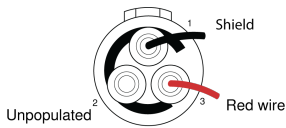
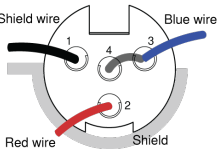
Series	Cable Construction	Electrical Design	Polarity	Replacement Connector	For Use With	Wiring	Line Art (From Solder Side)
TL45-LEMO	1.1mm cable with single conductor and shield	2-Wire (Common Source)	Negative with respect to ground	WA411	Shure Lemo Bodypacks (AD1/ADX1-Lemo, Shure UR1M-Lemo, ULXD1-Lemo), Sennheiser SK5212, Lectrosonics SSM, and others	Red wire: Audio/ Bias(3) Shield: Ground(1)	
TL46-MTQG, TL47-MTQG, TL48-MTQG	1.6mm cable with 2 conductors, 2	3-Wire (Source Follower)	Positive with respect	WA430	All Shure TA4F Bodypacks	Red wire: Bias(2) Blue wire: Audio(3) Shield wire: Ground(1)	

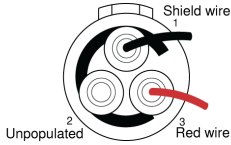
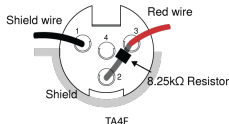
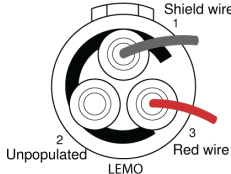
Series	Cable Construction	Electrical Design	Polarity	Replacement Connector	For Use With	Wiring	Line Art (From Solder Side)
	shield wires and shield		to ground			Shield: Ground (Shell)	
TL46-LEMO, TL47-LEMO, TL48-LEMO	1.6mm cable with 2 conductors, 2 shield wires and shield	2-Wire (Common Source)	Negative with respect to ground	WA416	Shure Lemo bodypacks (ADX1-Lemo, Shure UR1M-Lemo, ULXD1-Lemo), Sennheiser SK5212, Lectrosonics SSM, and others	Red wire: Audio/Bias(3) Blue wire: Not connected Shield wire: Ground(1)	
TL47-NC, TL48-NC	1.6mm cable with 2 conductors, 2 shield wires and shield	2-Wire (Common Source)	Negative with respect to ground	LEMO: WA416, Shure TQG/ TA4F: WA430, Lectrosonics TA5F: WA435	Termination Dependent	Red wire: Audio/Bias Blue wire: Not connected Shield wire: Ground Shield: Ground (Shell)	 

Converting LEMO to TA4F

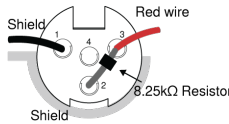
Series	Cable Construction	Electrical Design	Polarity	Replacement Connector	For Use With	Wiring	Line Art (From Solder Side)
TL45-LEMO	1.1mm cable with single conductor and shield	2-Wire (Common Source)	Negative with respect to ground	Shure TQG/ TA4F: WA430	Termination Dependent	Shield: Ground(1) Red wire: Audio/Bias(3) 8.25kΩ Resistor between pin 2 and 3	

Series	Cable Construction	Electrical Design	Polarity	Replacement Connector	For Use With	Wiring	Line Art (From Solder Side)
						Shield: Ground(Shell)	
TL46-LEMO, TL47-LEMO, TL48-LEMO	1.6mm cable with 2 conductors, 2 shield wires and shield	2-Wire (Common Source)	Negative with respect to ground	Shure TQG/TA4F: WA430	Termination Dependent	Shield wire: Ground(1) Red wire: Audio/Bias(3) Blue wire: Not connected 8.25kΩ Resistor between pin 2 and 3 Shield: Ground(Shell)	

TA5F Wiring for Lectrosonics Bodypacks (Servo Biased Wiring)

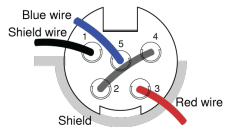
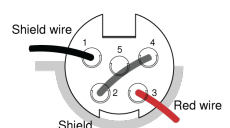
Series	Cable Construction	Electrical Design	Polarity	Replacement Connector	For Use With	Wiring	Line Art (From Solder Side)
TL46-MTQG, TL47-MTQG, TL48-MTQG	1.6mm cable with 2 conductors, 2 shield wires and shield	3-Wire (Source Follower)	Positive with respect to ground	WA435	Lectrosonics TA5F bodypacks	Red wire: Bias(3) Blue wire: Audio(5) Shield wire: Ground(1) Shield: Ground(Shell) Jumper between 2 and 4	
TL46-LEMO, TL47-LEMO, TL48-LEMO, TL47-NC, TL48-NC	1.6mm cable with 2 conductors, 2 shield wires and shield	2-Wire (Common Source)	Negative with respect to ground	WA435	Lectrosonics TA5F bodypacks	Red wire: Audio/Bias(3) Blue wire: Not connected Shield wire: Ground(1) Shield: Ground(Shell)	

Series	Cable Construction	Electrical Design	Polarity	Replacement Connector	For Use With	Wiring	Line Art (From Solder Side)
						Jumper between 2 and 4	

Hirose Wiring for Sony Bodypacks

Notes:

- When using TwinPlex mics with Sony Hirose 4-pin bodypacks, Shure recommends purchasing Shure –MTQG versions and not –NC versions. This facilitates an easier termination due to the lack of circuitry required in Shure 3-wire/MTQG TA4F products.
- Due to the thin cable on TwinPlex and the large boot on Hirose connectors, heat shrink may be required to build up the cable under the boot where the crimp connection is made and where the cable exits the boot
- The TwinPlex Microdot (-MDOT) version can be used with 4-pin Hirose adapters from DPA (DPA part # DAD6008)

Series	Cable Construction	Electrical Design	Polarity	Replacement Connector	For Use With	Wiring	Line Art (From Solder Side)
TL45-LEMO	1.1mm cable with single conductor and shield	2-Wire (Common Source)	Negative with respect to ground	Hirose 4-pin-KMC-9BPD-4P	Sony Hirose Bodypacks (WRT)	<p>Red wire: Audio/Bias: Into resistor and capacitor</p> <p>1: 8.2k resistor</p> <p>2: Jumper to 4</p> <p>3: 1 uF capacitor (-)</p> <p>4: Ground/shield-jumper to 2</p> <p>Split Shield to shell</p> <p>Blue wire: not used</p>	<p>8.2k Resistor</p> <p>Red wire</p> <p>ground</p> <p>1 uF Capacitor (electrolytic)</p>
TL46-LEMO, TL47-LEMO, TL48-LEMO, TL47-NC, TL48-NC	1.6mm cable with 2 conductors, 2 shield wires and shield	2-Wire (Common Source)	Negative with respect to ground	Hirose 4-pin-KMC-9BPD-4P	Sony Hirose Bodypacks (WRT)	<p>Red wire: Audio/Bias: Into resistor and capacitor</p> <p>1: 8.2k resistor</p> <p>2: Jumper to 4</p> <p>3: 1 uF capacitor (-)</p>	<p>8.2k Resistor</p> <p>Red wire</p> <p>ground</p> <p>1 uF Capacitor (electrolytic)</p>

Series	Cable Construction	Electrical Design	Polarity	Replacement Connector	For Use With	Wiring	Line Art (From Solder Side)
						4: Ground/shield-jumper to 2 Split Shield to shell Blue wire: not used	
TL46-MTQG, TL47-MTQG, TL48-MTQG	1.6mm cable with 2 conductors, 2 shield wires and shield	3-Wire (Source Follower)	Positive with respect to ground	Hirose 4-pin-KMC-9BPD-4P	Sony Hirose Bodypacks (WRT)	1: Red wire (Bias) 2: Blue wire (Audio) 3: Jumper to 4 4: Ground/shield-jumper to 3 Split Shield to shell	

LEMO Wiring for Q5X Bodypacks

Wiring Diagram

Series	Cable Construction	Electrical Design	Polarity	Replacement Connector	For Use With	Wiring	Line Art (from Solder Side)
TL46-LEMO1, TL47-LEMO1, TL48-LEMO1	1.6 mm cable with 2 conductors, 2 shield wires, and shield	2-Wire (Common Source)	Positive with respect to ground	FFS. 01.250.DLAE24	Q5X PlayerMic Q5X PlayerMicS Q5X Incognito Q5X CoachMic Q5X RefMic Q5X BeltMic	Red wire: Audio/Bias(1) Shield wire: Ground (Shell)	
TL46-LEMO6, TL47-LEMO6, TL48-LEMO6	1.6 mm cable with 2 conductors, 2 shield wires, and shield	2-Wire (Common Source)	Positive with respect to ground	FVG. 03.306.CLAC27Z	Q5X AquaMic Q5X AquaMicL	Red wire: Audio/Bias (1) Shield wire: Ground (2)	

MTQG Connector Assembly

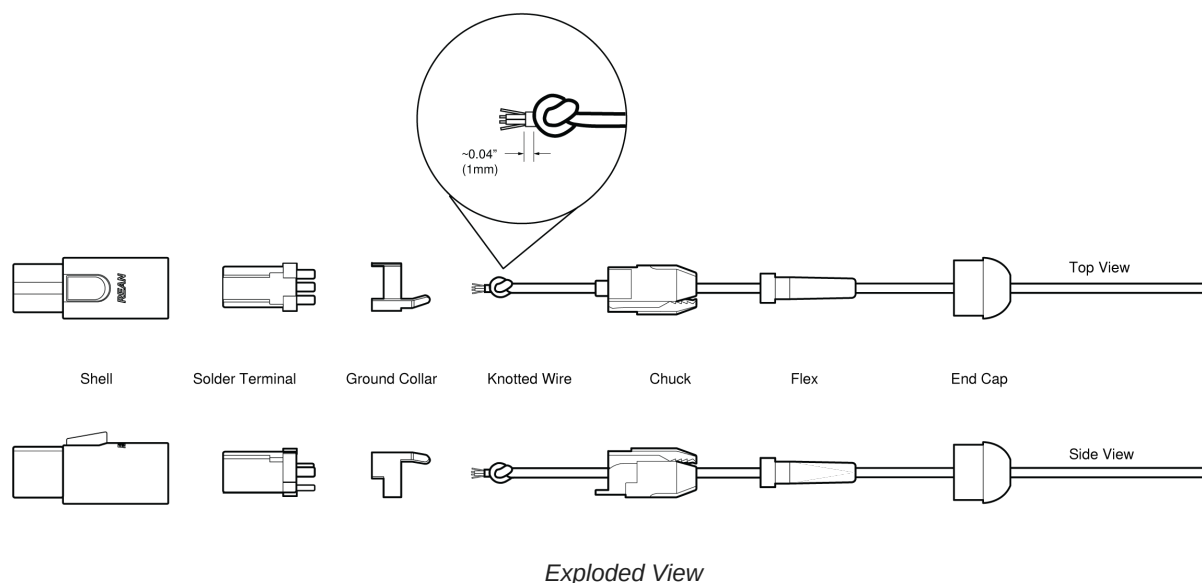

Note: Make sure to solder the shield to ground collar.

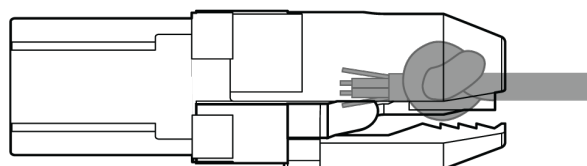

RPM400 Preamplifiers

The RPM400 preamplifiers offer exceptional dynamic range utilizing an active gain circuit in a concise and small package. They are offered in two connector versions: TA4F and LEMO, which allows you to quickly take a wireless TL microphone and make it a wired solution. These preamplifiers require phantom power and can efficiently operate across a wide range of supply voltages from 12-48v.

Features

- Active circuit design with neutral gain mimics wireless for consistent gain output across wired or wireless applications.
- High RF immunity against unwanted interference.
- Short, compact design.
- Belt clip and table mounting kits for easy placement for a variety of applications.

Preamplifier Mounting Kit

TwinPlex XLR microphones include an under table mounting kit for temporarily or permanently mounting the amplifier. It includes preamplifier clip, 4 screws, and premium dual lock adhesive. The mounting kit and accessories are also sold separately.

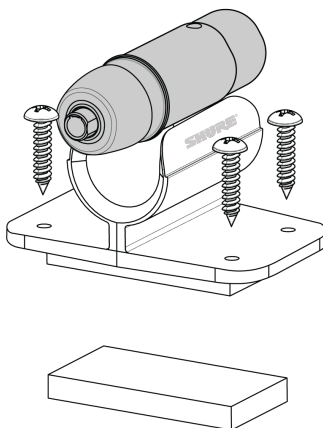

Specifications

TwinPlex Microphone

Microphone Capsule

Dual-Diaphragm, Prepolarized Condenser

Polar Pattern

Omnidirectional

Frequency Response

20 Hz to 20 kHz

Sensitivity

TL46	-37.0 dBV (14.1 mV) at 1 kHz[2]
TL45, TL47, TL48	-45.0 dBV (5.62 mV) at 1 kHz[2]

Self-Noise, A-Weighted, Equivalent Acoustical

TL46	24.0 dB SPL-A
TL45, TL47, TL48	24.5 dB SPL-A

Signal-To-Noise Ratio[3]

TL46	70.0 dB
TL45, TL47, TL48	69.5 dB

Output Clipping Level

3.0 dBV, 1 kHz at 1% THD, typical

Maximum SPL[4]

TL46	134.0 dB SPL, 1 kHz at 1% THD, typical
-------------	--

TL45, TL47, TL48	142.0 dB SPL, 1 kHz at 1% THD, typical
-------------------------	--

Dynamic Range

TL46	110.0 dB typical
TL45, TL47, TL48	117.5 dB typical

Microphone Current Draw

120 to 240 μ A, typical

Bias Voltage

Recommended Operating Voltage

5 V DC

Housing

Molded ABS

Polarity

MTQG, XLR connector	Positive pressure on diaphragm produces positive voltage on pin 3 with respect to pin 1
LEMO, NC, MDOT	Positive pressure on diaphragm produces negative voltage on pin 3 with respect to pin 1.

Cable Diameter

TL45	1.1 mm
TL46, TL47, TL48	1.6 mm

Cable Length

MTQG, LEMO, MDOT	66 in. (1.67 m)
NC, XLR connector	96 in. (2.43 m)

Net Weight

with cable

12.0 g (0.42 oz.)

[1]All specifications measured with a 48 Vdc phantom power supply. The microphone operates at lower voltages, but with slightly decreased headroom and sensitivity.

[2] 1 Pa=94 dB SPL

[3]S/N ratio is the difference between 94 dB SPL and equivalent SPL of self noise, A-weighted

[4]THD of microphone preamplifier when applied input signal level is equivalent to cartridge output at specified SPL

RPM400 Preamplifier

Output Impedance

100 Ω

Connector

Three-pin professional audio (XLR), male, balanced

Output Clipping Level

3.0 dBV, 1 kHz at 1% THD, typical

Microphone Bias

5 V DC

Polarity

Positive pressure on diaphragm produces positive voltage on pin 2 with respect to pin 3

Sensitivity

TL46 into RPM400LEMO	-31.0 dBV (28.2 mV) at 1 kHz[2]
TL45, TL47, TL48 into RPM400LEMO	-39.0 dBV (11.2 mV) at 1 kHz[2]
TL46 into RPM400MTQG	-37.0 dBV (14.1 mV) at 1 kHz[2]
TL45, TL47, TL48 into RPM400MTQG	-45.0 dBV (5.62 mV) at 1 kHz[2]

Maximum SPL[4]

TL46 into RPM400LEMO	128.0 dB SPL, 1 kHz at 1% THD, typical
TL45, TL47, TL48 into RPM400LEMO	136.0 dB SPL, 1 kHz at 1% THD, typical
TL46 into RPM400MTQG	134.0 dB SPL, 1 kHz at 1% THD, typical
TL45, TL47, TL48 into RPM400MTQG	142.0 dB SPL, 1 kHz at 1% THD, typical

Dynamic Range

TL46 into RPM400LEMO	104.0 dB typical
TL45, TL47, TL48 into RPM400LEMO	111.5 dB typical
TL46 into RPM400MTQG	110.0 dB typical
TL45, TL47, TL48 into RPM400MTQG	117.5 dB typical

Power Requirements

MTQG	11–52 V DC[1]phantom power, 4.8 mA
LEMO	11–52 V DC[1]phantom power, 5.5 mA

[1]All specifications measured with a 48 Vdc phantom power supply. The microphone operates at lower voltages, but with slightly decreased headroom and sensitivity.

[2] 1 Pa=94 dB SPL

[3]S/N ratio is the difference between 94 dB SPL and equivalent SPL of self noise, A-weighted

[4]THD of microphone preamplifier when applied input signal level is equivalent to cartridge output at specified SPL

Dimensions

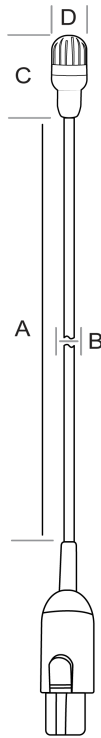

	A	B	C	D
	Cable Length	Cable Diameter	Microphone Length	Microphone Diameter
TL45	66 in. (1.67M)	1.1MM	13.5MM	5.6MM
TL46	66 in. (1.67M)	1.6MM	13.5MM	5.6MM
TL47-MTQG, TL47-MDOT, TL47-LEMO	66 in. (1.67M)	1.6MM	13.5MM	5.6MM
TL47-XLR, TL47-NC	96 in. (2.43M)	1.6MM	13.5MM	5.6MM
TL48-MTQG, TL48-MDOT, TL48-LEMO	66 in. (1.67M)	1.6MM	19MM	5.3MM
TL48-XLR, TL48-NC	96 in. (2.43M)	1.6MM	19MM	5.3MM

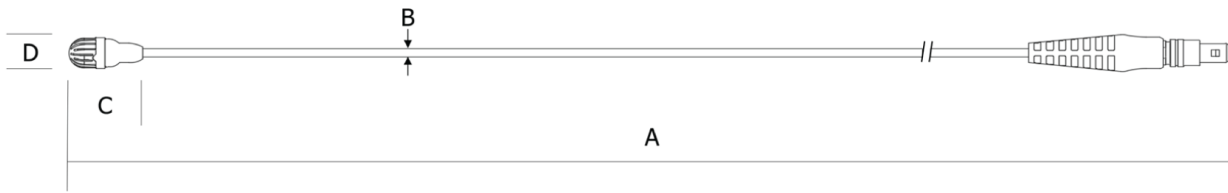

Dimensions

Series	A Cable Length	B Cable Diameter	C Microphone Length	D Microphone Diameter
TL46-LEMO1, TL46-LEMO6	70 in. (1.78m)	1.6 mm	13.5 mm	5.6 mm
TL47-LEMO1, TL47-LEMO6	70 in. (1.78m)	1.6 mm	13.5 mm	5.6 mm
TL48-LEMO1, TL48-LEMO6	70 in. (1.78m)	1.6 mm	19 mm	5.3 mm

Frequency Response

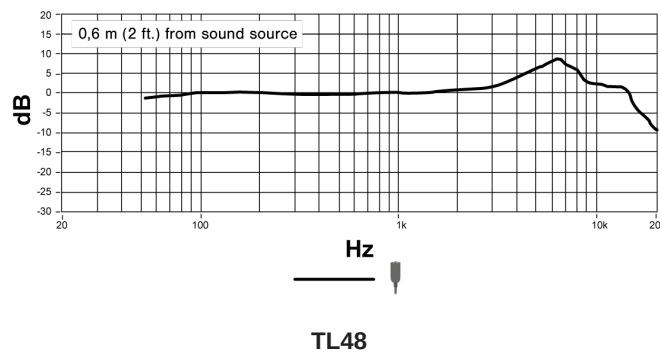
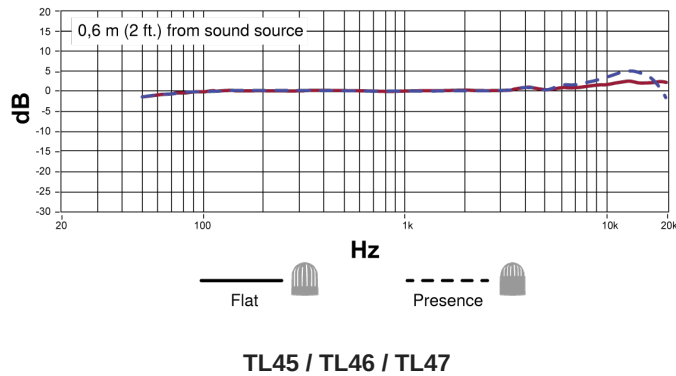

Dimensions

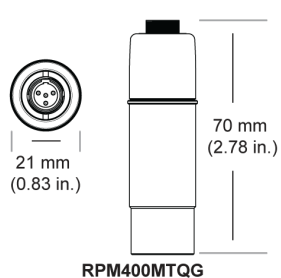
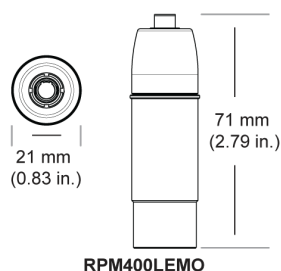

Certifications

Note: Testing is based on the use of supplied and recommended cable types. The use of other than shielded (screened) cable types may degrade EMC performance.

CE Notice:

Hereby, Shure Incorporated declares that this product with CE Marking has been determined to be in compliance with European Union requirements. The full text of the EU declaration of conformity is available at the following site: <https://www.shure.com/en-EU/support/declarations-of-conformity>.

Authorized European Importer / Representative:

Shure Europe GmbH
 Department: Global Compliance
 Jakob-Dieffenbacher-Str. 12
 75031 Eppingen, Germany
 Phone: +49-7262-92 49 0
 Fax: +49-7262-92 49 11 4
 Email: EMEAsupport@shure.de

UKCA Notice:

Hereby, Shure Incorporated declares that this product with UKCA Marking has been determined to be in compliance with UKCA requirements. The full text of the UK declaration of conformity is available at the following site: <https://www.shure.com/en-GB/support/declarations-of-conformity>.

Authorized UK Importer / Representative:

Shure UK Limited
 Unit 2, The IO Centre, Lea Road,

Waltham Abbey, Essex, EN9 1 AS, UK