



PGXD

Wireless System

Shure online user guide for PGX Digital wireless systems.
Version: 2.1 (2022-E)

Table of Contents

PGXD Wireless System	3	Adjusting Gain	11
Quick Start	3	Bodypack Transmitter	11
General Description	6	Handheld Transmitter	12
	6	Single System Setup	12
System Components	7	Multiple System Setup	13
All systems include	7	Compatible Frequencies	13
Vocalist systems include	7	Manual Channel and Group Selection (receiver only)	14
Lavalier, Headworn, and Instrument systems include	7	Locking and Unlocking Controls	14
Guitar systems include	7	Troubleshooting	15
Receiver Controls and Connectors	7	Specifications	16
Transmitter Controls and Connectors	8	Certifications	19
Transmitter Indicator LED	9	PGXD1, PGXD2	20
Batteries	10	PGXD4	20
Wearing the Bodypack Transmitter	10	LICENSING INFORMATION	20
Adjusting Levels	11	Information to the user	20
		Australia Warning for Wireless	20

PGXD Wireless System

Quick Start

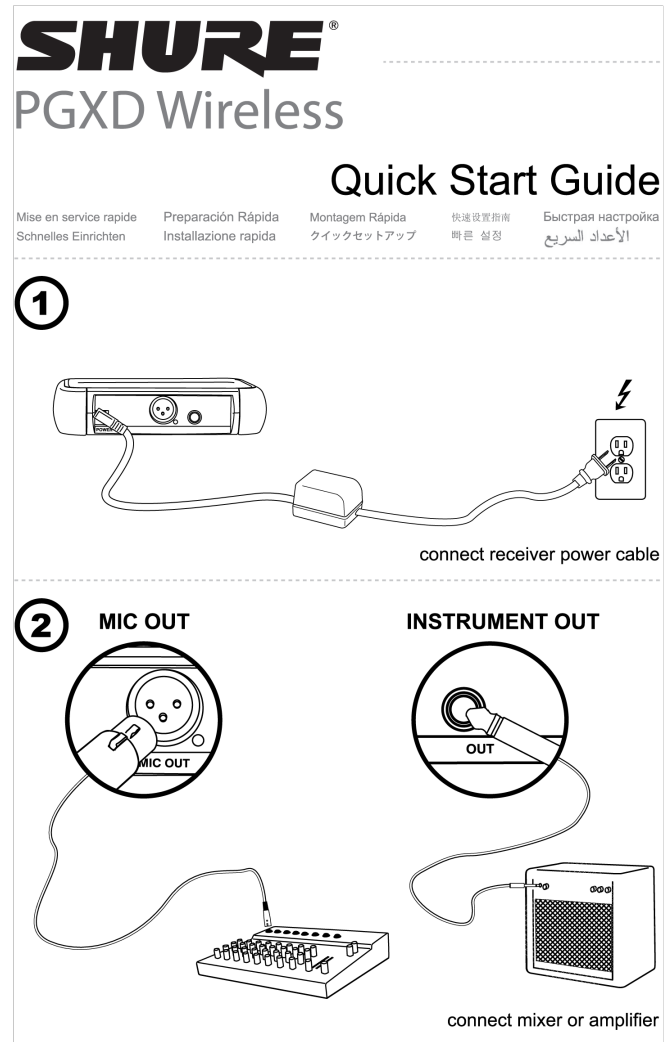

3



2 x AA

add transmitter batteries

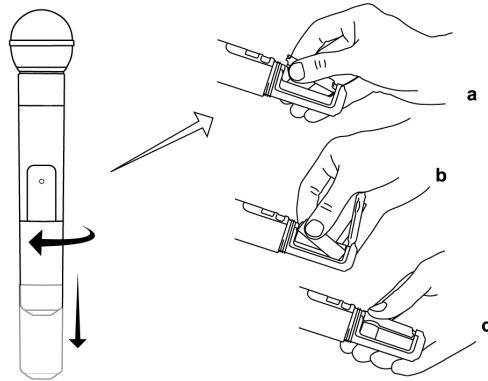
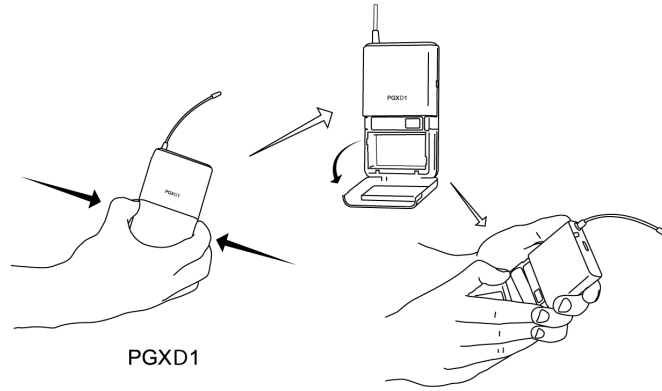

4 
power

scan for a clear channel and power up

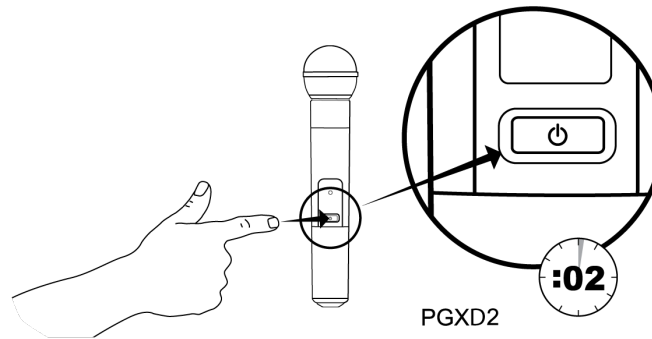
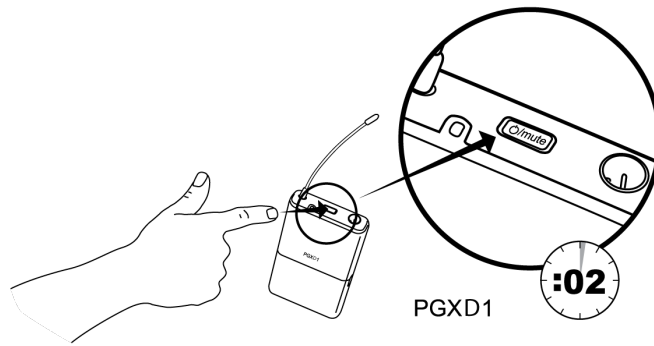
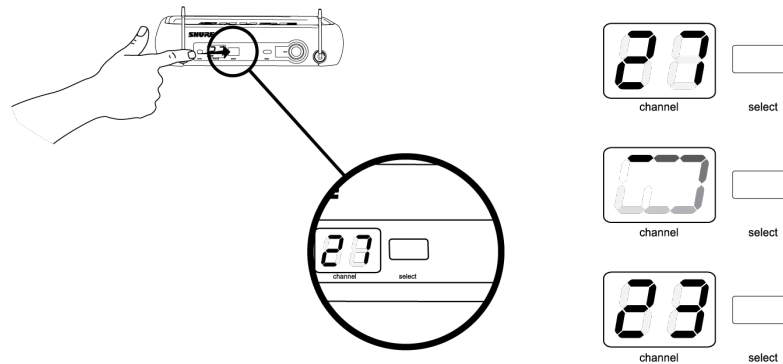

- One-touch setup and operation
- Up to 10 hours of battery life (9 hours, PGXD2)
- Up to 200 foot range (line-of-sight)
- 900 MHz operation—free from white spaces or DTV interference

System Components

All systems include

- PGXD4 receiver
- 2 AA alkaline batteries
- Power supply
- User guide

Vocalist systems include

- PGXD2 handheld transmitter
- Microphone head (choice of PG58, SM58[®], SM86, Beta 58A[®] or Beta 87A^{*})

Available only in select markets

- Microphone clip

Lavalier, Headworn, and Instrument systems include

- PGXD1 bodypack transmitter
- Microphone (choice of WL93, WL185, PGA31 or Beta 98H/C)

Guitar systems include

- PGXD1 bodypack transmitter
 - 1/4" to mini 4-pin guitar cable (WA302)
-

Receiver Controls and Connectors

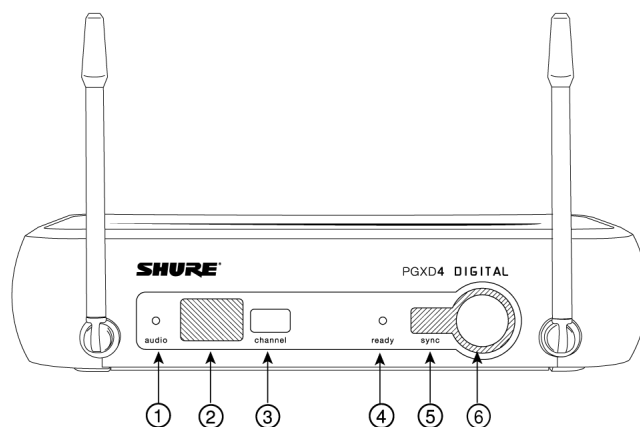

Front Panel

1. **audio** LED: Indicates strength of incoming audio signal: green for normal, amber for strong and red for clipping.
2. LED Screen: Displays group and channel setting. See "Single System Setup" for details.
3. **channel** button: Changes group and channel setting. See "Single System Setup" for details.
4. **ready** LED: Indicates system ready and receiving an RF signal from the transmitter. Also indicates battery level of the transmitter:
 - Green = transmitter battery level normal
 - Red = low battery (typically less than 60 minutes with alkaline batteries)

with NiMH rechargeable batteries, when the indicator turns red there will be little to no remaining life.

5. Infrared (IR) port: Sends IR signal to transmitter for sync.
6. **sync** button: Press to synchronize transmitter with receiver group and channel settings.
7. AC adapter jack
8. Adapter cord tie-off
9. XLR microphone output jack
10. 6.35 mm (1/4") instrument level output jack

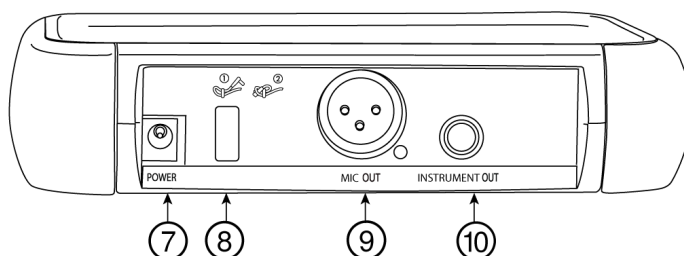

Back Panel

Transmitter Controls and Connectors

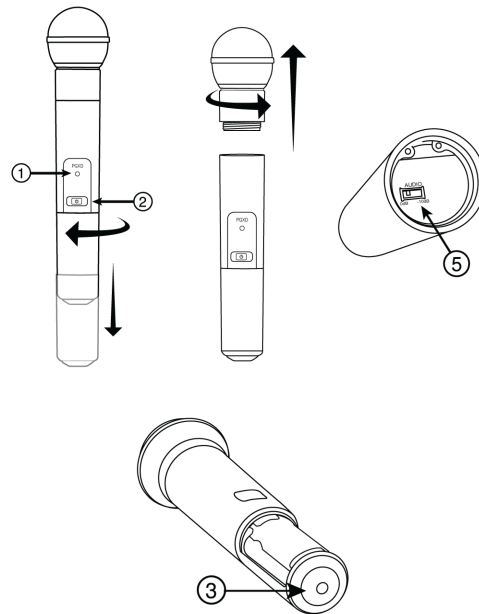

- ① Indicator LED: Displays battery level, mute, and IR transmission status (see table).
- ② Power/Mute Switch: Press to mute or unmute. Press and hold to power on or off.
- ③ Infrared (IR) port: Receives infrared beam to synchronize frequencies. **When using multiple systems, only one transmitter IR port should be exposed at a time.**
- ④ 4-Pin Microphone Input Jack
- ⑤ Audio Gain Adjustment

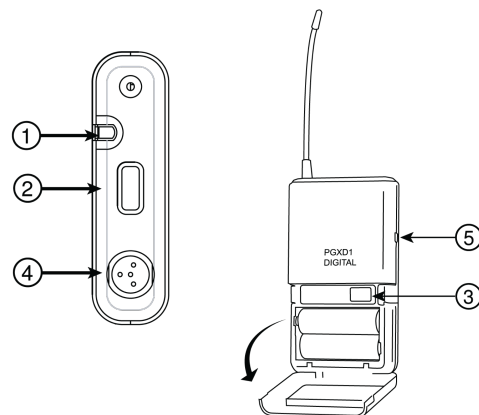

Transmitter Indicator LED

LED Indicator	Status
Green	Ready
Flashing green	Controls locked
Amber	Mute on
Solid red	Battery power low
Flashing red	Batteries dead (change batteries to power on transmitter)
Rapidly flashing red	IR transmission in process
Flashing amber and red	Battery power low and mute on

Batteries

- A fresh set of alkaline batteries lasts up to 10 hours (9 hours, PGXD2).
- The transmitter LED and the receiver **ready** LED glow red to indicate low battery (typically less than 60 minutes remaining).
- NiMH rechargeable batteries may be used. However, the low battery indicator functions differently. When it turns red, there may be little to no remaining life.
- When the LED flashes red, the batteries must be replaced to power on the transmitter.

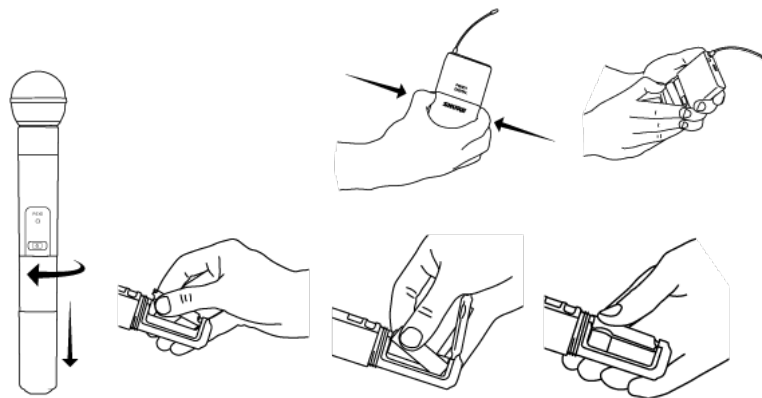

Wearing the Bodypack Transmitter

Clip the transmitter to a belt or slide a guitar strap through the transmitter clip as shown.

For best results, the belt should be pressed against the base of the clip.

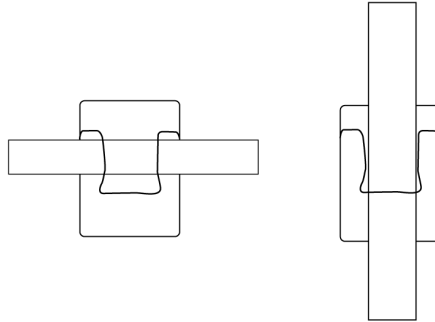

Adjusting Levels

Adjusting Gain

For best audio quality, set transmitter gain so the **audio** LED on the receiver flickers green and amber during the performance. Decrease gain if the signal clips (LED turns red).

The amber LED may appear to be red when viewed at an angle. For best results, monitor the LED from directly in front.

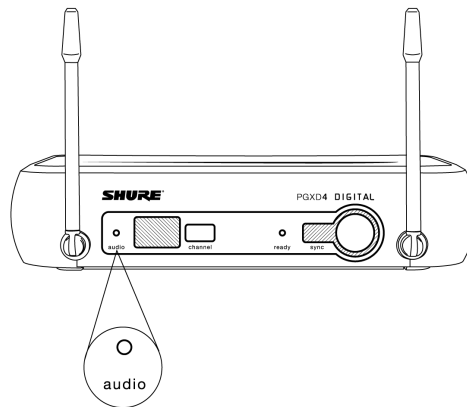

Bodypack Transmitter

The bodypack has 26 dB of audio gain adjustment.

- Increase gain (clockwise +) for microphones
- Decrease gain (counterclockwise -) for guitars or high-output instruments

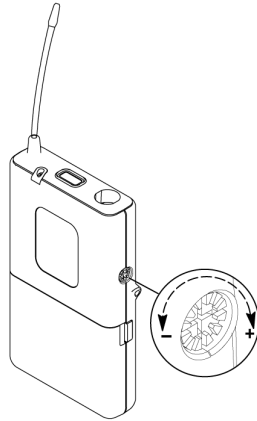

Handheld Transmitter

Access the gain switch by unscrewing the head of the microphone.

Use the tip of a pen or a small screwdriver to move the switch.

- **0dB:** For quiet to normal vocal performance.
- **-10dB:** Use only if audio is distorted due to high vocal levels.

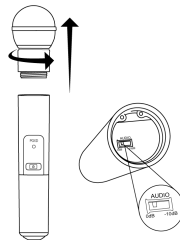

Single System Setup

1. **Scan:** Use the scan feature on the receiver to find a clear channel.
 1. **LED screen** displays current channel

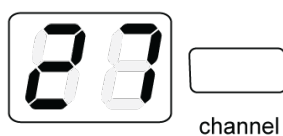

2. Press **channel** button to scan for a clear channel
3. System scans for the channel with the least interference

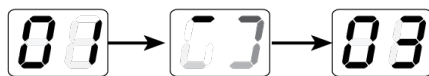

2. **Synchronize:** Synchronize the transmitter to the receiver by aligning the infrared (IR) ports and pressing the **sync** button. **Make sure the IR ports are closely aligned.** After a successful sync, the transmitter LED momentarily flashes red and the receiver **ready** light illuminates.

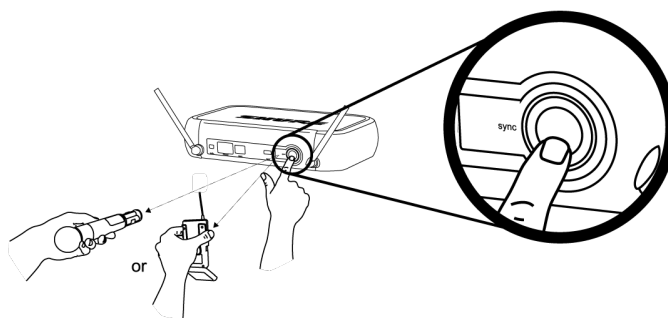

This wireless system may be affected by RF interference when used in proximity to other wireless devices such as cordless phones, baby monitors, and two-way radios. For best results, use the scan and sync feature before each use or if you experience problems.

Multiple System Setup

Use the following steps to ensure the best performance when installing multiple wireless systems at the same location.

1. Turn all receivers **on** and all transmitters **off**.

Turn on any other digital equipment that could cause interference during the performance so it will be detected during the frequency scans in the following steps.

2. Make sure the group number is the same for all receivers (see Manual Group Selection).
3. Perform a scan using the first receiver.
4. Turn on the first transmitter and sync it to the receiver.
5. Repeat for each system.
 - After syncing each transmitter, leave it on so that scans from the other receivers will not select that channel.
 - Be sure only one transmitter IR port is exposed when synchronizing each system.

Compatible Frequencies

When operating multiple systems simultaneously, choose one group from the following table and set all systems to different channels within that group.

Number of Systems	Group (by band)		
	X8	X8A (Australia)	X8B (Brazil)
2	0 to 9	0 to 9	0 to 9
3	3 to 9	3 to 9	3 to 9
4	3 to 9	--	3 to 9
5	7 to 9	--	--

Manual Channel and Group Selection (receiver only)

Using the receiver to scan for a channel is the best way to find the best frequency for your system. However, for multiple system setup, you may need to manually set the group number.

1. Press and hold the **channel** button.
2. Hold the button until the channel or group display begins flashing.
3. Release and press the button again to advance the setting. At the desired channel or group number, wait for the flashing to stop. This activates the new setting.
4. Transfer the new frequency setting to the transmitter using the automatic sync function.

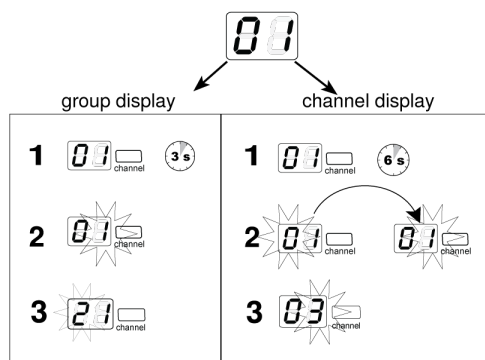

Locking and Unlocking Controls

Locking the system controls prevents accidental muting or channel adjustment during performances.

To lock the controls: With the transmitter **off**, hold the **power** button down until the green LED flashes (~5 seconds)

To unlock the controls: With the transmitter **on**, hold the **power** button down until the green LED flashes (~5 seconds)

To lock the channel: Hold the **channel** button until the numbers flash (~10 seconds)

To unlock the channel: Hold the **channel** button until the numbers flash (~5 seconds)

Troubleshooting

Issue	Indicator Status	Solution
No sound or faint sound	Receiver ready LED on	Verify all sound system connections
	Receiver ready LED off	Turn on transmitter Make sure the batteries are installed correctly Perform automatic transmitter setup Insert fresh batteries
	Receiver LED screen off	Make sure AC adapter is securely plugged into electrical outlet
	Transmitter indicator LED flashing red	Replace transmitter batteries
	LED screen shows dash and value	Error code displayed. Contact your Shure reseller for assistance.
	Transmitter LED flashes red for 7 seconds after attempting to sync	Transmitter and receiver incompatible. Contact your Shure reseller for assistance.
Noise bursts or audio dropouts	N/A	Change receiver and transmitter to a different channel Remove nearby sources of RF interference such as cordless or cell phones, computers, wireless routers, media players, digital signal processors, and security systems. Replace transmitter batteries If using multiple systems, change the frequency of one of the active systems
Distortion	Audio LED on receiver indicates clipping (red)	Reduce transmitter gain
Distortion increases gradually over time	Transmitter power light glowing or flashing red	Replace transmitter batteries
Sound level different from cabled guitar or microphone or when using different guitars	N/A	Adjust transmitter gain as necessary

Issue	Indicator Status	Solution
Cannot turn transmitter on	Transmitter LED slowly flashing red	Replace transmitter batteries
	Transmitter LED rapidly flashing red	Contact your Shure reseller for assistance

Specifications

Working RangeLine of Sight

60m (200 ft)[1]

RF Carrier Range

X8	902–928 MHz
X8A	915–928 MHz
X8B	902–907.5 MHz, 915–928 MHz

Audio Frequency Response

20 to 20,000 Hz

System Gain

PGXD1	6.35 mmConnector	0 dBat minimum gain setting
	XLR output	-12.5 dBat minimum gain setting
PGXD2		XLR output: -54.5 dBV/Paat –10 dB gain setting

Total Harmonic Distortion

<0.02%, A-weighted, typical

Dynamic Range

>108 dB, A-weighted

Operating Temperature Range

-18°C (0°F) to +50°C (122°F)

Transmitter Audio Polarity

Positive pressure on microphone diaphragm produces positive voltage on pin 2 with respect to pin 3 of low-impedance output and the tip of the high impedance 1/4-inch output

[1] Actual range depends on RF signal absorption, reflection and interference.

PGXD1

Audio Input Level

at minimum gain setting	+10 dBVmaximum
--------------------------------	----------------

at maximum gain setting	-16 dBVmaximum
--------------------------------	----------------

Gain Adjustment Range

26 dB

Input Impedance

1 M Ω

RF Output Power

10 mW

Pin Assignments

1	ground (cable shield)
2	+ 5 V Bias
3	audio
4	On instrument adapter cable, pin 4 floats

Dimensions

108 mm x 64 mm x 19 mm

Weight

128 g (4.5 oz.) (without batteries)

Housing

Molded Polycarbonate Case

Power Requirements

2 AA size alkaline or rechargeable batteries

Battery Life

up to 10 hours

PGXD2

Audio Input Level

at minimum gain setting	+10 dBVmaximum
at maximum gain setting	-16 dBVmaximum

Gain Adjustment Range

26 dB

Input Impedance

1 M Ω

RF Output Power

10 mW

Pin Assignments

1	ground (cable shield)
2	+ 5 V Bias
3	audio
4	On instrument adapter cable, pin 4 floats

Dimensions

108 mm x 64 mm x 19 mm

Weight

128 g (4.5 oz.) (without batteries)

Housing

Molded Polycarbonate Case

Power Requirements

2 AA size alkaline or rechargeable batteries

Battery Life

up to 10 hours

PGXD4

Dimensions

40 mm x 181 mm x 104 mm

Weight

289 g (10.2 oz.)

Housing

ABS

Sensitivity

-102 dBmat 10^{-5} BER

Power Requirements

12-18 V DC at 150 mA, supplied by external power supply (tip positive)

Audio LED

Red	2
Amber	12
Green	50

Configuration

Impedance Balanced

Maximum Audio Output Level

XLR connector	-2.5 dBV
6.35 mm Connector	+10 dBV

Impedance

XLR	50 Ω
6.35 mm Connector	50 Ω

Pin Assignments

XLR	1=ground, 2=audio, 3=no audio
6.35 mm (1/4") TRS	Tip=audio, Ring=no audio, Sleeve=ground

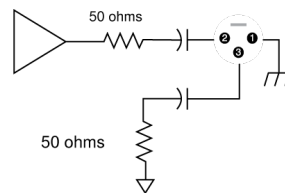

XLR Output

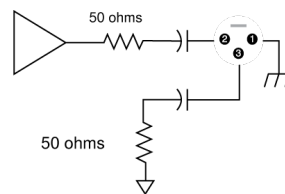

1/4" Output

Certifications

This Class B digital apparatus complies with Canadian ICES-003. Cet appareil numérique de la classe B est conforme à la norme NMB-003 du Canada.

PGXD1, PGXD2

Certified under FCC Part 15. (**FCC ID:** DD4PGXD1, DD4PGXD2).

PGXD4

Approved under the Declaration of Conformity (DoC) provision of FCC Part 15.

LICENSING INFORMATION

Licensing: A ministerial license to operate this equipment may be required in certain areas. Consult your national authority for possible requirements. Changes or modifications not expressly approved by Shure Incorporated could void your authority to operate the equipment. Licensing of Shure wireless microphone equipment is the user's responsibility, and licensability depends on the user's classification and application, and on the selected frequency. Shure strongly urges the user to contact the appropriate telecommunications authority concerning proper licensing, and before choosing and ordering frequencies.

Information to the user

This device complies with part 15 of the FCC Rules. Operation is subject to the following two conditions:

1. This device may not cause harmful interference.
2. This device must accept any interference received, including interference that may cause undesired operation.

Note: This equipment has been tested and found to comply with the limits for a Class B digital device, pursuant to part 15 of the FCC Rules. These limits are designed to provide reasonable protection against harmful interference in a residential installation. This equipment generates uses and can radiate radio frequency energy and, if not installed and used in accordance with the instructions, may cause harmful interference to radio communications. However, there is no guarantee that interference will not occur in a particular installation. If this equipment does cause harmful interference to radio or television reception, which can be determined by turning the equipment off and on, the user is encouraged to try to correct the interference by one or more of the following measures:

- Reorient or relocate the receiving antenna.
- Increase the separation between the equipment and the receiver.
- Connect the equipment to an outlet on a circuit different from that to which the receiver is connected.
- Consult the dealer or an experienced radio/TV technician for help.

Note: EMC conformance testing is based on the use of supplied and recommended cable types. The use of other cable types may degrade EMC performance.

Changes or modifications not expressly approved by the manufacturer could void the user's authority to operate the equipment.

Australia Warning for Wireless

This device operates under an ACMA class licence and must comply with all the conditions of that licence including operating frequencies. Before 31 December 2014, this device will comply if it is operated in the 520-820 MHz frequency band.

WARNING: After 31 December 2014, in order to comply, this device must not be operated in the 694-820 MHz band.