



VLI Series
Digital Infrared Language Distribution System







User Manual

V1.0 Version



Meanings of Signs

■ Safety Precautions

There are signs in both the user manual and the equipments to indicate the hidden risk to your and others' personal safety and property. These signs are used to help you to operate the equipments safely and correctly, whose meanings are illustrated as bellow. Please be sure that you understand all of them before you start to operate the equipments.

 Warning	This is to remind the user that all the operation should be done following the instructions mentioned in the manual, or, death and body injure may happen due to wrong operation.
 Caution	This is to remind the user that the dangerous internal voltage that has not been grounded may cause electricity shock.
	Warning: in order to avoid electrical shock, please do not open the chassis, nor put unnecessary parts inside the chassis. Please contact the qualified personnel for after service.
	CE Certification: means this product has already met the designated standards by the EU, and the user can use it safely.
	SGS Certification: this means this products has passed the test of the general quality test by the biggest surveyor in Swiss.
	This product has been certified by ISO9001 International Quality Organization (German Rhine TUV)

■ General Information Indication

	This is to list some content which may cause unsuccessful operation or setting and some information that should be noticed.
	This is to indicate the page where related theme or material can be found.

Important Precautions



Warning

To ensure the proper function of the equipment and the safety of the user, please following the under mentioned instructions during installation, use and maintenance:

Installation Instructions

◆ Please do not use the equipment in the following environment: shaking, dusty, oily, smoky, conducting dusty, filled of corrosive gas and flammable gas. Also, please don't expose the equipment to high temperature, condensing, wind, rain. Electrical shocking, fire and wrong operation can also damage the product.

◆ When screwing and cabling, please don't drop the sweepings and wire leads into the controller's vent hole, or, fire, malfunction and wrong operation may be caused.

◆ After the installation, please be sure that the vent hole is not been blocked, or, the heat will not be yielded properly and fire, malfunction and wrong operation may be caused.

◆ Please don't wire or plug/unplug the cable while it's still live, or, electrical shock and circuit damage may happen.

◆ The installation and wiring should be stable, and the poor contact may cause wrong operation.

◆ In the place where sever interference exists, shielded cable should be used as the I/O cable for the high frequency signal to improve the transmitting quality.

Wiring Instruction

◆ Before the installation and wiring, please cut all the power supply, or electrical shock or damage to the equipment can be caused.

◆ This product should be well grounded before using.

◆ After the installation and wiring, all the sundries should be cleaned up, and the covers and panels should be put back and fixed well in order to avoid electrical shock.

Operation and maintenance instruction

◆ Please don't touch the connectors when they are electrified, or electrical shock or wrong operation may happen.

◆ Please cut the power first before cleaning the cleaning and winding up the connectors. Operation when they are electrified can cause electrical shock.

◆ Please cut the power first before wiring or disconnecting the communication signal cable, extension modules or control units, or damage can be caused to the equipments.

◆ Please do not dismantle the equipment to avoid damages to the internal components.

◆ Please read this manual carefully, and ensure that all your operations are safe before changing the program, debugging the program, turning on the system and stopping the operation.

◆ The button cell can only be replaced when the equipment is not electrified. If the replacement has to be done with the electricity is on, it should be operated by professional person with insulating gloves on.

Product Disposal instruction

When disposing the product, please take the following instructions:

Preface

“Digital IR Language Distribution System user manual” mainly introduces the way of operation, main specifications and the frequently seen malfunction elimination methods for VIS-VLI700A-4/-8/-16 (Digital IR Transmitter), VIS-VLI701A (Digital Infrared Radiator), and VIS-VLI703A-4/-8/16/-32 (Digital Infrared receiver).

This manual is provided with the intent to provide operation instructions, not for maintenance. Changes and updates may be applied to this manual after it was issued, please check with the manufacturer or your distributor for the latest version.

All rights related to this manual is reserved by VISSONIC Electronics Limited. No organization or person can use part or all of the content of this manual for business usage without permission from VISSONIC Electronics Limited.

This manual is protected by the “Copyright Law of the People's Republic of China” and other IPR protection laws, no disperse or copy is accepted without paper permission from VISSONIC Electronics Limited.

Version

Version	Update	Date
1.0		2019.4.15

VERSION:V1.0

Edit by Jackson Huang

CONTENT

Chapter 1 Overview	7
1.1 About	7
1.2 Equipments	7
1.3 System Advantages	7
1.4 Factors that affect the IR radiation	2
1.4.1 The directivity of receiving and emitting.....	2
1.4.2 The relation between the radiator and the seats arrangement.....	3
1.4.3 The surface of the walls, ceiling, floor and curtain.....	4
1.4.4 The coverage of the radiating panel.....	4
1.4.5 Floor area of overlapping and multi-path effects.....	5
Chapter 2 Digital Infrared Transmitter	5
2.1 Overview	6
2.2 Features	6
2.3 Installation	6
2.4 VIS-VLI700A-4, VIS-VLI700A-8 ,VIS-VLI700A-16 Transmitter	6
2.5 Connection	8
2.5.1 To CLEACON full digital networked DSP conference system.....	8
2.5.2 To the interpreter.....	8
2.5.3 To the external audio source.....	8
2.5.4 To the emergency signal switch.....	8
2.5.5 To another transmitter.....	8
2.6 Controls and indicators	9
2.7 Interconnection	9
2.8 Specification	9
Chapter 3 Digital Infrared Radiator	10
3.1 Overview	10
3.2 Features of Radiator	10
3.3 VIS-VLI701A Front Panel	11
3.4 How to allocation the system	11
3.4.1 The installation of the radiator.....	11
3.4.2 Wiring of the radiator.....	12
3.4.3 Rectangle Coverage.....	13
3.5 Installation steps of radiator	13

3.6 Delay switch Settings.....	13
3.6.1 How to calculate the delay.....	14
3.7 Installation of the radiator.....	14
3.8 Connection between the radiator and the transmitter.....	15
3.9 Controls and indicators.....	15
3.10 Interconnection.....	15
3.11 Specification.....	15
Chapter 4 Digital Infrared Receiver.....	16
4.1 Overview.....	16
4.2 VIS-VLI703A-4/8/16/32 Description.....	16
4.3 VIS-VLI703A-4/8/16/32 features.....	16
4.4 Operations of the receiver.....	17
4.5 Controls and Indicators.....	17
4.6 Interconnections.....	17
4.7 Specification.....	17
Chapter 5 Interpreter Unit.....	18
4.8 Features.....	18
4.10 Description.....	17
4.11 Descriptions of panel display.....	17
4.12 Operator.....	18
4.13 Specification.....	18
Chapter 5 Accessories.....	19
5.1 VIS-TC50A Charger and Storage Box.....	19
5.2 VIS-BTPS Battery Pack.....	19
5.3 VIS-HPI Interpreter Headset.....	19
5.4 VIS-HPD Conference Headphone.....	19
Chapter 6 Frequently seen malfunction and maintenance.....	19

Chapter 1 Overview

1.1 About

VISSONIC independently developed this system, which applies full-digital modulating technology. With this system, the translator simultaneously interpreting the language according to the speaker's original voice and the translated languages are transmitted to the whole meeting hall via modulated IR and can be received by the delegated with the earphone and the IR receiver with preferred channel on the language they understand.

Digital IR Simultaneous Translation System is a system using IR to transmit voice. Because light travels in straight lines, there is no signal outside of an enclosed room, thus, it has very good confidentiality. Within the room, due to the scattering and diffusion of the IR light on the surface of the wall, floor, ceiling, the IR signal will form a compact light net. As long as it is within the range where the IR light can cover, the receiver can be allocated randomly.

This system can also be used for other applications, such as music distribution. It has high precision working frequency, stability, high confidentiality, and is interference and eaves-dropping proof. This system can be applied in international meetings halls from small to large scale, or in multi-language education organizations.

1.2 Equipments

VISSONIC language distribution system include:

Digital IR Transmitter

VIS-VLI700A-4 4 channel transmitter

VIS-VLI700A-8 8 channel transmitter

VIS-VLI700A-16 16 channel transmitter

Digital IR radiator

VIS-VLI701A

Digital IR receiver

VIS-VLI703A-4 4 channels receiver

VIS-VLI703A-8 8 channels receiver

VIS-VLI703A-16 16 channels receiver

VIS-VLI703A-32 32 channels receiver

Interpreter Headset

VIS-HPI for interpreter unit

Charger and Storage Box

VIS-TC50A charger and storage box for Digital infrared receiver

The system can be composed of one or more of the above mentioned equipment.

1.3 System Advantages

Digital IR Language Distribution System includes transmitter, radiator, IR receiver and charging box. The transmitter encoding the audio signal, compresses, modulate it to many carrying waves and then transmit it to the radiator. The radiator emits the carrier signal via IR light. The IR receiver receives, modulates and converts the signal into audio output or other data. They have the following advantages:

◆ **Apply simultaneous interpretation**

It is important to allow every delegates hear clearly in a multi-language conference system, thus, a simultaneous interpretation system is a

necessity. The translators translate the original language, then the translated language is distributed all over the whole meeting hall and the receiver select the language they need and can hear it with the earphone.

◆ Using IR to transmit

IR is part of the electromagnetic radiation spectrum, which includes visible light, radio wave and other radiation wave. The wave length of IR is longer than the visible light, thus, IR cannot penetrate the walls and ceiling. In this way, the confidentiality of the meeting can be ensured, tapping and interference can be avoided. VISSONIC's IR Simultaneous Translation System uses the IR modulated by DQPSK to transmit the signal. At the same time, this system also needs radio frequency permission.

◆ Advanced digital technology

Full-digital DQPSK modulation technology has been used to gain high frequency usage and strong anti-interference ability.

The system applies full-digital audio processing technology to ensure the high audio quality, eliminate overhearing between channels and noise etc.

◆ Free from the interference of fluorescent light

The traditional IR Simultaneous Translation System is easily interfered by the fluorescent light. VISSONIC has applied unique technology and has solved this problem thoroughly. It works on 2-6MHZ frequency, and avoided the interference from various kinds of lighting sources.

◆ Flexible channel selection

VISSONIC has left huge flexibility to the users while designing the channels, and has provided 32 general quality audio channels. (31 different translation channel + 1 original voice). The general quality channels take smaller bandwidth and can be used to transmit audio

signals.

◆ Flexible and convenient using methods

Using the IR system gives the delegates the freedom of going around the whole meeting

room., because the signal transmit in the air, and the system has no physical connection, thus the activities can only be limited by the walls of the meeting room. The IR receiver is light and delicate, which can be put in the pocket of the user's T-Shirt or coat.

◆ Simple Installation and maintenance

The system is easy to install (the time it takes depends on the allocation and correction of the radiating panels). The only job to be done is connect the equipments together, and maintenance is just charging.

Once the installation is finished, the system can be expanded any time. If the meeting scale enlarges, what have to be done is just add more IR receivers in to the system, and the basic structure doesn't have to be changed.

1.4 Factors that affect the IR radiation

1.4.1 The directivity of receiving and emitting

VISSONIC digital IR distribution system has wide receiving angle, which can allow the receiver to get perfect sound quality no matter how they are placed. Please check Fig.1-1.

VISSONIC radiating panel's cover area is a ellipse, which means as the distance gets larger, the dimension of the radiation area gets larger till a certain limit is reached. Please check the Fig.1-2 "radiating panel coordinate illustration.

1 IR receiver 's best receiving range

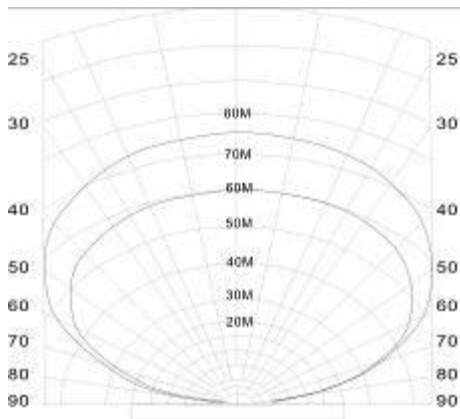

Fig.1-2 radiator coordinate illustration

1.4.2 The relation between the radiator and the seats arrangement

If the receiver is accurately directed to the radiating panel, the receiver can get the best effect signal. If the radiating panel or the receiver gets off the light axe, the received energy will descend. But within, as long as there is no direct screen between the receiver and the radiating panel (for example screened by the delegate's body or other objects), the energy can still be sufficient.

To ensure the best signal transmission, the allocation of the radiating panels has to be suited to the seats' positions. The ideal way is to have the radiating panel emit directly onto the seats. This is one way of designing the installation solution.

Obviously, we should prefer the way of installation shown in Fig.1-4. But in actual installation, the way shown in Fig.1-4 can hardly be achieved, and then, we need employ the help of reflection to achieve the full cover of the signal.

In Fig. 1-5, this delegate's receiver can not only receive the direct emit from the radiating panel but also the reflected signal from all

directions. In this situation, the reflected signal can strengthen the signal. In Fig.1-6, this delegate receives only reflected signals, and the signal he gets in this situation is relatively weaker, but sufficient enough. In order to avoid people's

screening of the IR signal, the installation height of the radiating panel should be higher than 2.5m.

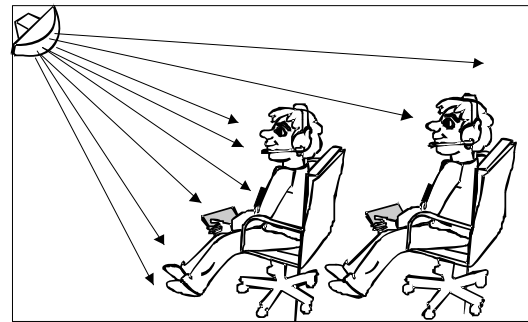

F.1-3. Installation with obstacles

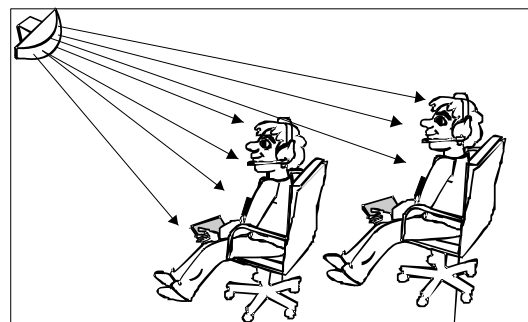

Fig.1-4 installation without obstacles

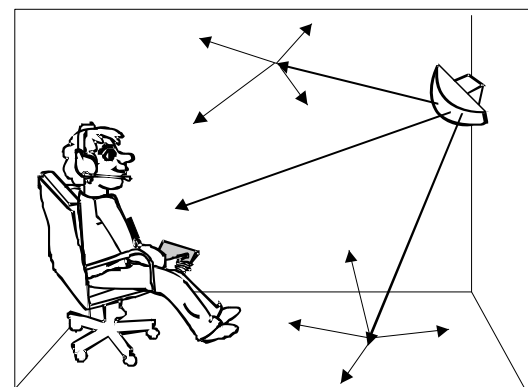

Fig.1-5. Direct emission and reflect

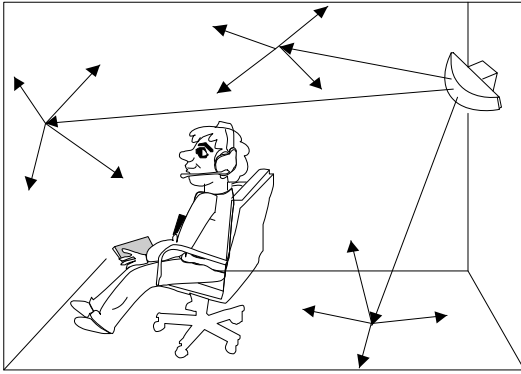

Fig. 1-6 Reflect

1.4.3 The surface of the walls, ceiling, floor and curtain

IR is just like visible light, and can be reflected by shining, smooth surface and absorbed by dark, rough surface. The reflected light generally can help by transmitting signals, and won't cause any damaging interference. In a room with shining, smooth surfaces, the required power of the radiating panel is lower than the room with dark, rough surfaces, as curtain and carpet.

Otherwise, the reflecting effect can be very different when the texture of the floor is different: the shadow of the walls and furniture can interfere the IR transmitting. But if we use enough radiating panels and allocate them properly, this problem can be solved. At the same time, it should be noticed that the radiating panels cannot be positioned to face the windows without curtains, which can reduce the radiating effect. As shown in Fig. 1-7, there is difference in the reflection effects for floors of different texture.

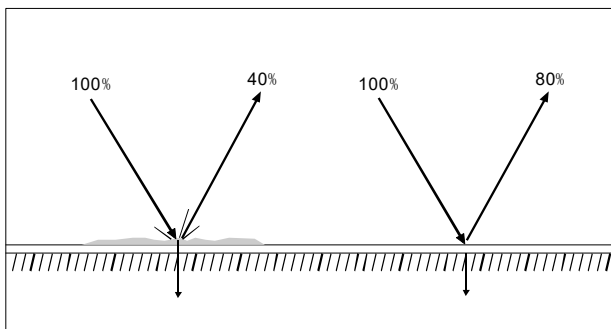
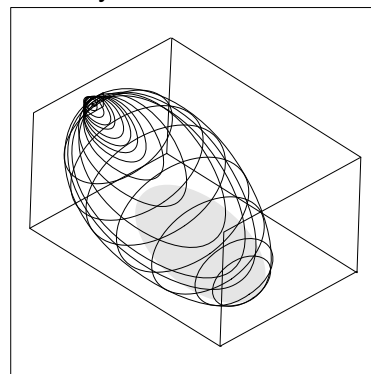

Fig. 1-7 there is difference in the reflection effects for floors of different texture.

1.4.4 The coverage of the radiating panel

In the system, the coverage is decided by radiating controller's carrier wave and the radiating panel's output power, and the coverage will be enlarged when there are more radiating panels. The radiating panels' total radiant intensity is allocated in the controller according to the amount of the carrier wave, and when the used carrier wave increase, the coverage's percentage will decrease accordingly.

As shown in the following figure (the white part), the crossing area of the radiation allocation area and the receiving area of the people's receiver is the coverage. Within the coverage area, if the radiating signal can reach the receiver directly, the intensity of the direct signal can be enough to be received. Here the following are some illustration figures for installation for your reference:



15° installation figure

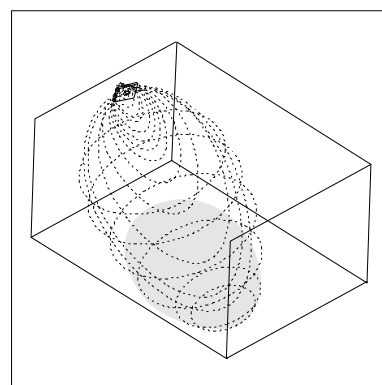

45° installation figure

The signal delay reduces the coverage area

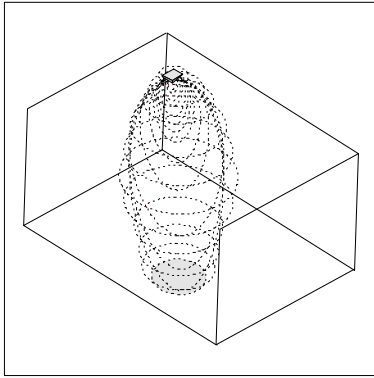

90° installation figure

1.4.5 Floor area of overlapping and multi-path effects

The installed radiation board in meeting room, if was overlapping, the overall coverage may be greater than the radiation of two separate panels. Radiation intensity is greater than the area needed. (As shown in the Figure)

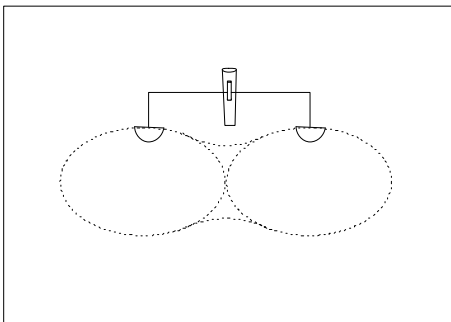

The added area increases the coverage

The receiver machine receive signal from many radiation boards. It may be offset by delay, or can't receive signal at all. Signal delay can be compensated by radiating panel switch delay compensation.

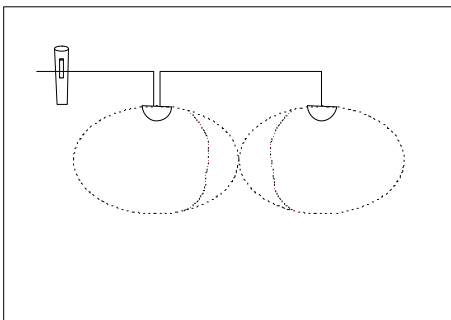

Chapter 2 Digital Infrared Transmitter

2.1 Overview

VIS-VLI700A-4/-8/-16 IR transmitter is the main part of the digital IR distribution system. To transfer the simulation audio, compress code, full digital DQPSK transfer. The system can send 16 kinds of languages. IR transmitter can be installed on 19-inch standard rack, the easy storage and safekeeping.

2.2 Features

1. Compliant to IEC 61603-7 and IEC 60914
2. Compatible with any other IR simultaneous interpretation system compliant to IEC 61603-7
3. DQPSK digital modulation/demodulation technology
4. Transmitting in 2~8 MHz frequency band eliminates disturbance from high frequency lighting systems
5. Capable of distributing a maximum of 4,8,16 or 32 audio channels
6. Auxiliary mode for distribution of music to all channels during a break
7. Slave mode for distribution of signals from another transmitter allows multiple rooms to be used
8. Radiator and system status indication via display and indicators
9. Each transmitter can be assigned a unique name by the installer for easy identification in a multi-transmitter system
10. Automatic distribution of emergency messages to all channels
11. Automatic synchronization to the number of channels in use by the CLEACON system
12. Each audio channel can be assigned a language name for easy identification
13. Adjustable sensitivity for each input to enable fine tuning of audio levels, support levels indicating of audio input
14. Flexible configuration of channels and channel quality modes: Mono, standard quality, maximum 16 channels Mono, perfect quality, maximum 8 channels Stereo, standard quality, maximum 8 channels Stereo, perfect quality, maximum 4 channel
15. With 16 interpretation output channels for recording
16. Universal mains power facility allows worldwide use
17. Conference hall privacy; the congress venue itself acts as a barrier to infrared signals escaping and being overheard, as infrared is unable to pass through opaque objects such as walls
18. Suitable for various kinds (small/medium/large international) of conference halls and outdoor venues
19. Support the interpreter unit connection directly(by optional firmware VIS-VLI700-FW)
20. Support 16 channel analogue audio input and 16 channels analogue audio output.
21. Support 2 transmitters can work as master and slaver mode for 32 channel language distribution
22. Support optional Dante port for connecting to Dante network

2.3 Installation

The system controllers are made of metal and work with many other equipments.

Furthermore, the system controller can also be installed on standard 19" cabinet, as shown in the following figure.

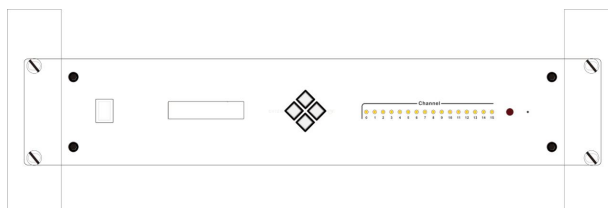

2.4 VIS-VLI700A-4, VIS-VLI700A-8 ,VIS-VLI700A-16 Transmitter

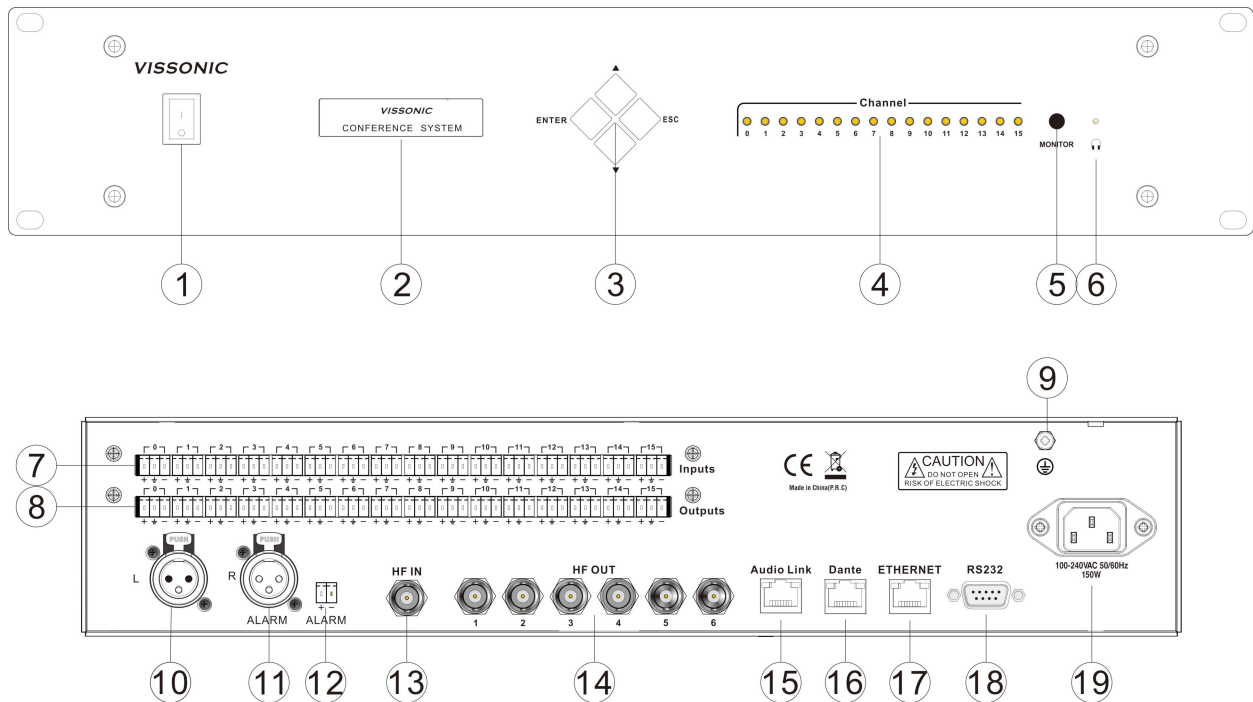

Front panel

- ① Power On/Off
- ② LCD display to show the setting menu
- ③ Menu button
- ④ Channel input status
- ⑤ Small radiator window
Small window is transmitting the same infrared signal as the radiator output for monitor purpose
- ⑥ Monitor headphone jack

Rear panel

- ⑦ Audio signal Input
4, 8, or 16 audio connectors to connect external audio input signals. The number of connectors depends on the transmitter model.
- ⑧ Audio signal output

4, 8, or 16 audio connectors. The number of connectors depends on the transmitter model.
System Power Indicator

- ⑨ Ground screw
Connect the processor unit to the ground
- ⑩ Auxiliary audio L input
Female XLR connectors for external audio inputs to connect auxiliary balanced audio signals such as music, floor language
- ⑪ Auxiliary audio R input
Female XLR connectors for external audio inputs to connect auxiliary balanced audio signals such as music, floor language or emergency audio signal
- ⑫ Fire alarm linked trigger interface
When this switch is closed, the emergency audio signal on the Aux-R input is distributed to all output channels and overriding all other audio inputs

⑬ HF signal input

1 BNC connector for receiving HF signal from other transmitter

⑭ HF signal output

6 BNC connectors for output HF signal to radiator. To each connector, up to 30 radiators can be connected

⑮ AUDIOLINK port

Connect to the conference main unit VIS-DCP2000 series or connect to the interpreter unit VIS-INT64

⑯ Dante

Connect to the Dante network, support maximum 8 ch digital audio in or 8 ch digital audio out

⑰ Ethernet

For communication between the conference main

2.5 Connection

Typical system connection includes:

- to CLEACON series full digital networked DSP conference system
- to interpreter unit
- to external audio sources
- to emergency signal switch
- to another transmitter

2.5.1 To CLEACON full digital networked DSP conference system

The transmitter can be directly connected to the AUDIOLINK network of the CLEACON full digital networked DSP conference system. Use an CAT5 cable to connect one of the AUDIOLINK sockets of the transmitter to the CLEACON network (see the next figure). The network mode must be enabled with the configuration menu.

unit and the PC under TCP/IP protocol to realize Web server and remote controlling; furthermore, it enables remote controlling by wireless touch panel through central control system

⑱ RS232

For connecting to a central control system for central controlling

⑲ Power inlet

support AC100V-240V 50Hz/60Hz, self-adaptive.

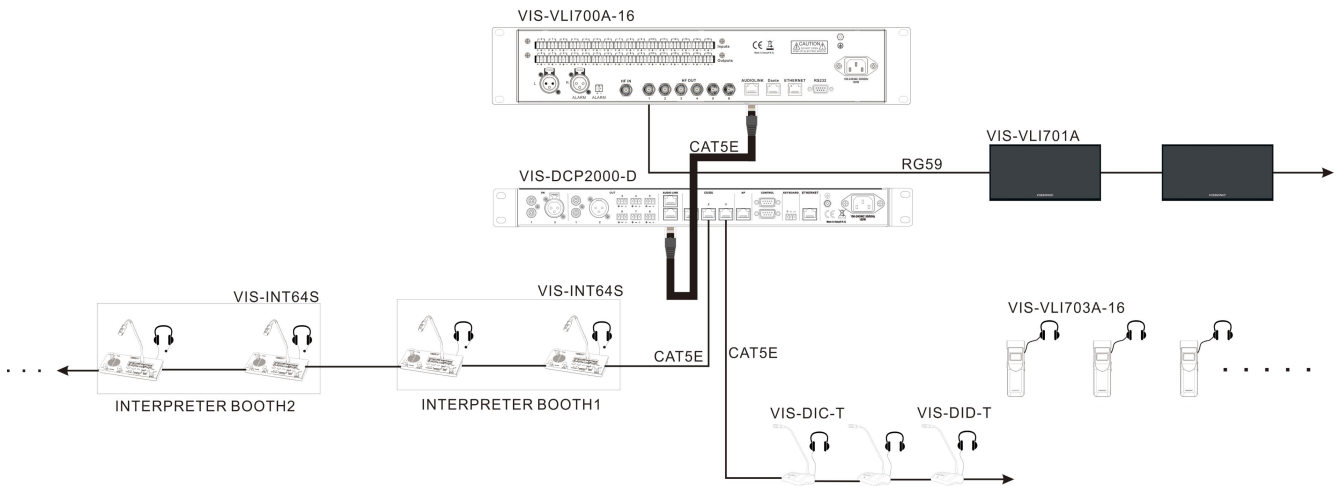

2.5.2 To the interpreter

The transmitter can be directly connected to the interpreter unit VIS-INT64 or VIS-INT64S by AUDIOLINK, but the power adaptor is necessary for the first interpreter unit connected from the transmitter unit. The power consumption is 9W, when the speaker of interpreter unit is on. The power adaptor is DC48V 3A. It is necessary to calculate power for connecting the sum of all interpreter unit and power loss of extension cable.

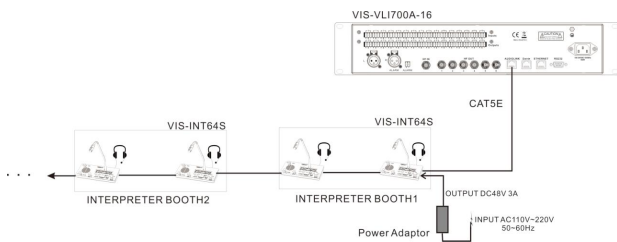

2.5.3 To the external audio source

The transmitter has up to 32 audio inputs (depending on the transmitter type and work mode) to interface with external asymmetrical audio sources, such as congress systems from other manufacturers or for music distribution. The audio signals (stereo or mono) are connected to the audio input 3pin connectors..

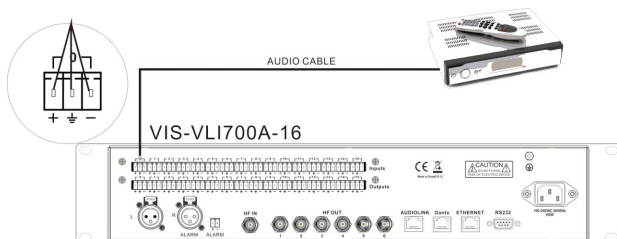

2.5.4 To the emergency signal switch

To use emergency function, fire alarm linked trigger interface (normally open) must be connected to the emergency switch connector. When the switch is closed, the audio signal on the Aux-Right input is distributed to all output channels and overriding all other audio inputs. "ALARM" will be displayed on the LCD at this moment.

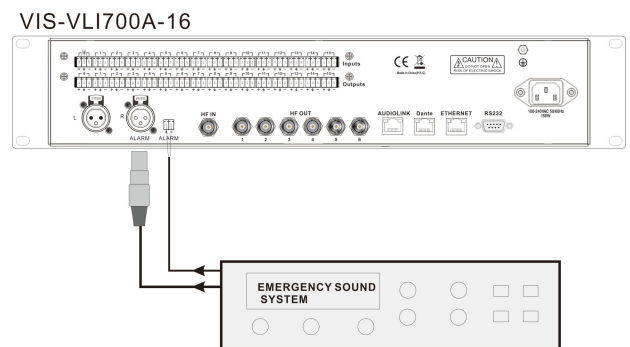

2.5.5 To another transmitter

Max. 7 transmitter can work as master and slave mode for distribution language on multiroom. The transmitter can be operated in slave mode to loop-through the IR radiator signals from a master transmitter. One of the six radiator outputs of the master transmitter is connected with an RG59 cable to the radiator signal loop-through input of the slave transmitter. The Transmission mode of the slave transmitter must be set to 'Slave'.

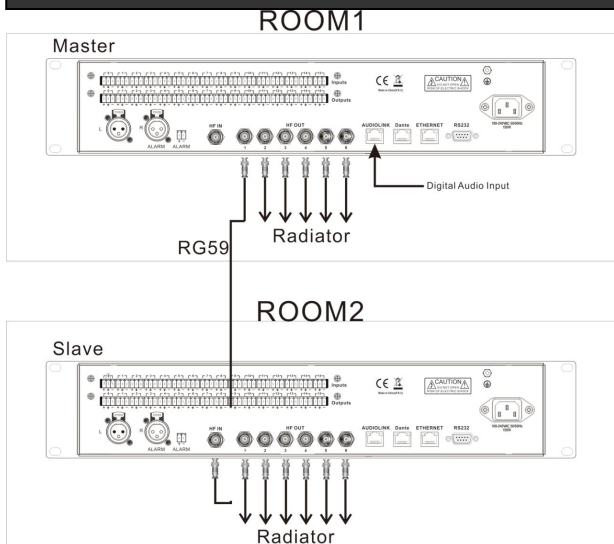

Two transmitters can work as a 32 channels distribution system. The transmitter can be operated in serial mode to loop-through the IR radiator signals from a master transmitter. One of the six radiator outputs of the master transmitter is connected with an RG59 cable to the radiator signal loop-through input of the serial transmitter. The Transmission mode of the serial transmitter must be set to 'Serial'.

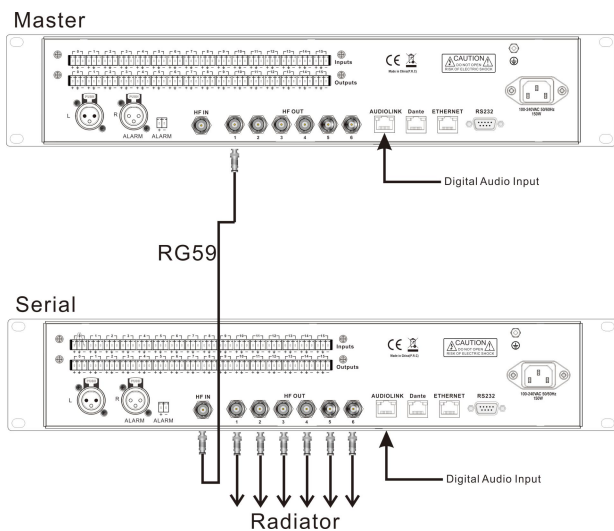

2.6 Controls and indicators

- ◆ Power switch
- ◆ Graphic LCD with back-lighting displays status and menu of the system configuration, supporting multi language menu
- ◆ Four buttons for configuration
- ◆ Channel active indicators

2.7 Interconnection

- ◆ 2 female XLR connectors for external audio inputs to connect auxiliary balanced audio signals such as music, floor language or emergency audio signal
- ◆ 16 audio signal output connectors (phoenix sockets) for output multi-channel audio
- ◆ 16 audio signal input connectors (phoenix sockets) to connect external unbalanced audio input signals
- ◆ 6 BNC connectors for output HF signal to radiator. To each connector, up to 30 radiators can be connected
- ◆ 1 BNC connector for receiving HF signal from another transmitter
- ◆ Audio-Link Port for connecting to Interpreter Unit(optional firmware VIS-VLI700-FW) or VIS-DCP2000
- ◆ DANTE port for connecting to Dante network for the digital audio(Optional VIS-DANTE module)
- ◆ Ethernet and RS232 ports for connection to computer
- ◆ Emergency signal interface: when the public emergency system is active, alarm signal can be fed to all channels automatically
- ◆ Power supply socket

2.8 Specification

System Specifications

Modulation.....	DQPSK, according to IEC 61603-7
Modulation frequency.....	2 to 8 MHz
Carriers 0 to 5:2 to 6 MHz, according to IEC 61603-7	
Frequency response.....	20 Hz to 10 kHz (-3dB) at standard quality;
	20 Hz to 20 kHz (-3dB) at perfect quality
THD at 1 kHz.....	<0.05%
Isolation.....	>80 dB
Dynamic range.....	>90 dB
Weighted SNR.....	>85 dBA

Electrical

Unbalanced audio inputs.....-12 dBV to +12 dBV nominal	
Balanced audio inputs.....-6 dBV to +18 dBV nominal	
Emergency switch connector	
2-PIN 3.81 mm	
	Pho
enix connector, alarm signal control input	
Headphone output.....32 Ohm to 2 kOhm	
HF input/output.....75 Ohm	
Power supply.....AC 100 V - 240 V, 50 Hz / 60 Hz	
Power consumption.....Maximum 25 W	

Mechanical	
Mounting.....	Brackets for 19" rack mounting or fixing to a table top; detachable feet for free-standing use on a table top
Dimensions h x w x d (mm)	88 × 483 × 266
Weight.....	7.5 kg
Color.....	Black

Chapter 3 Digital Infrared Radiator

3.1 Overview

The radiator is high power IR radiating equipment used to receive the carrier wave signal from the IR system controller and emit the signal in the form of IR. It support hand-in-hand connection and there can be maximally 30 radiating panels connected together.

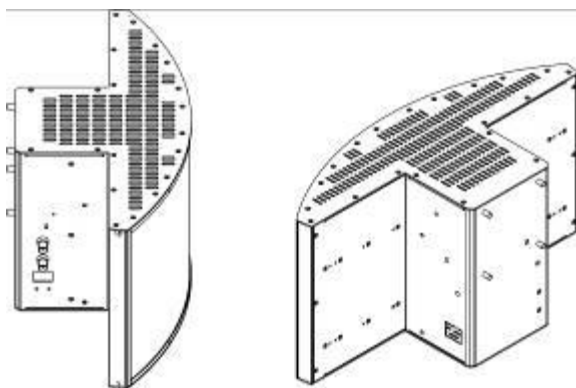

3.2 Features of Radiator

- Compliant to IEC 61603-7 and IEC 60914
- Compatible with any other IR system compliant to IEC 61603-7
- Maximum radiation range up to 76 meters.
- Cable delay compensation for differences in cable lengths between transmitter and radiators
- Half-power / full-power the operating mode can be selected with a switch
- Synchronization on/off with transmitter
- Connection to connect further radiators in a daisy chain
- Radiation angle $\pm 25^\circ$
- When the temperature of the radiator is too high, the system will automatically switch from full power to half power.
- For the use in conference rooms, even in daylight

3.3 VIS-VLI701A Front Panel

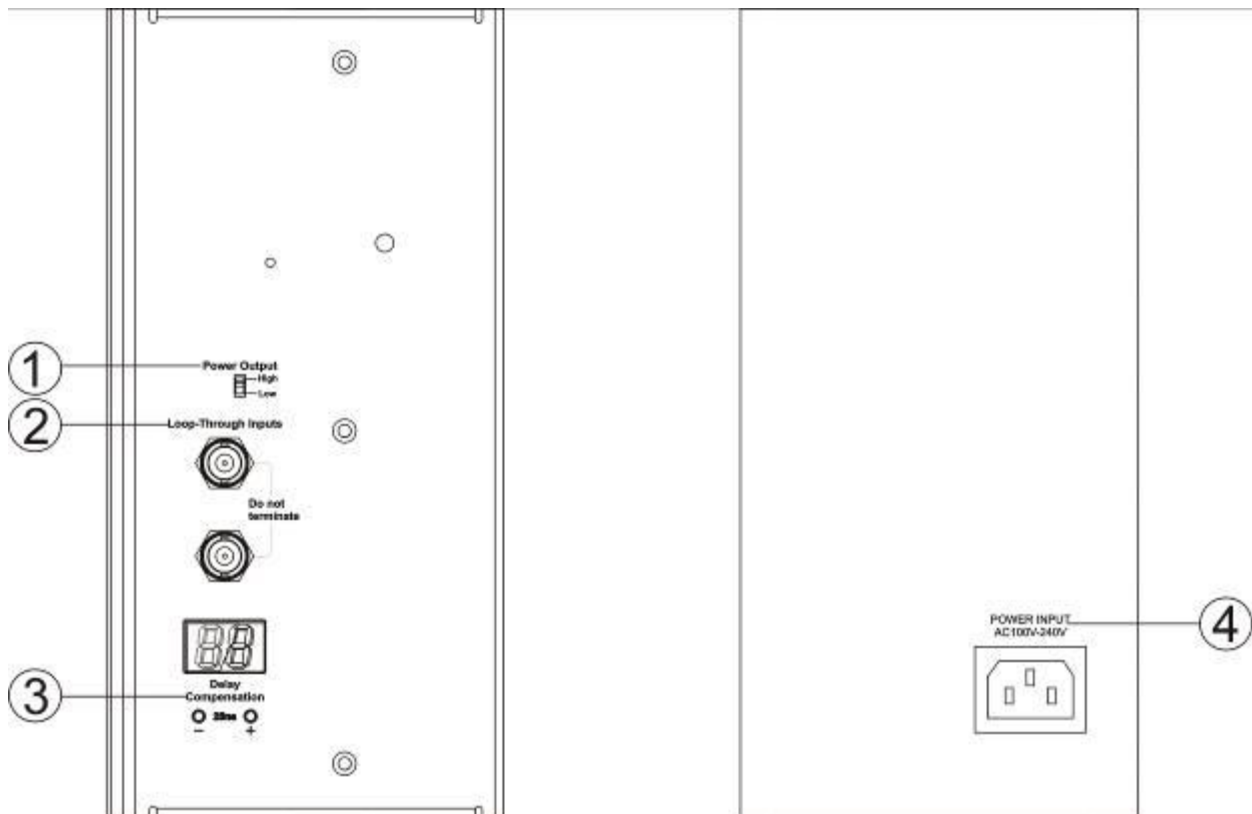

- ① **POWER OUTPUT**
Switch for the power of the radiated signal.
- ② **LOOP-THROUGH INPUTS**
Connected to the system controller's SIGNAL OUTPUTS interface or the former IR radiating panel's output interface.
- ③ **DELAY COMPENSATION*25**
Delay composition adjusting button, “+” is to delay increase, “-“ is to delay decrease. The value for adjusting will be displayed on the LCD above the button.
Delay composition range: 00~99, that is, from 0 (0*25) ns to 2475ns (99*25)
Cable delay coefficient:5.6ns/m, please refer to the cable's specifications for details.
☞ 3.6 “settings of the delay button”
- ④ **Power input interface: AC100V~240V**

50Hz/60Hz input

3.4 How to allocation the system

3.4.1 The installation of the radiator

The IR can reach the receiver by direct reflection or diffused reflection. In a conference hall, the delegates who sit behind others will not receiver IR signal if it has been screened by the front row of seats, which has to be taken into consideration when allocating the radiator. Thus, when the radiator should be installed as high as possible, and generally the height should be more than 2.5m and the radiator should face the whole conference hall from various directions to make sure their radiating area can cover the whole place.

If the radiator are installed highly enough, the signal intensity of the received IR signal will not decreased to zero in the shadow area, because IR can be reflected (same as the visible light).

When the radiator cannot be installed onto the existing ceiling, walls or bearing structures, they must be installed according to the above mentioned rules to ensure the proper signal transmission.

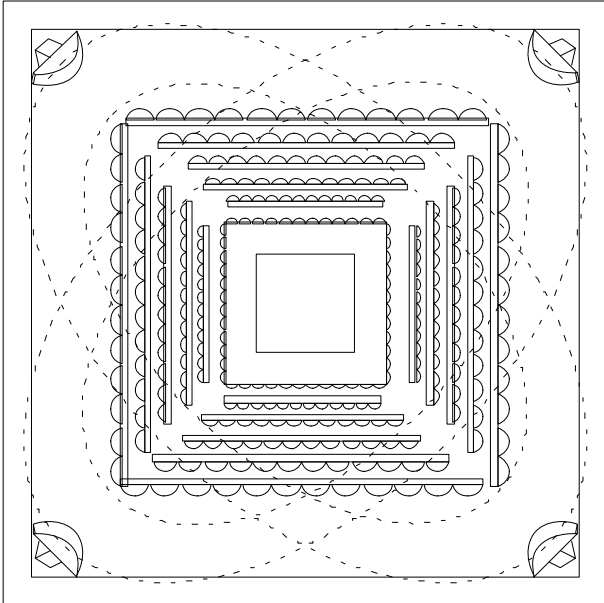

Fig.3-1 Square IR coverage

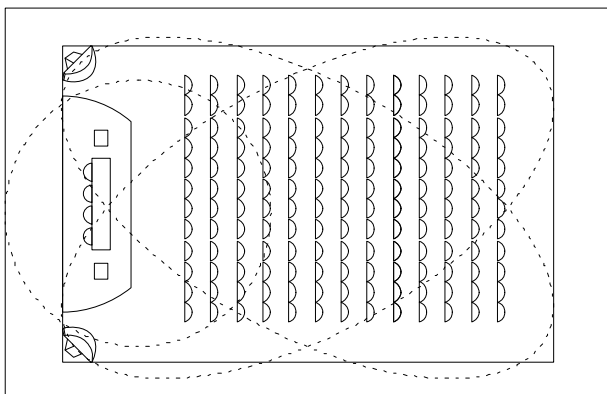

Fig.3-2 Audience seats and chairman seats coverage

If there are IR barricades in the room, extra radiator should be added to increase the radiation to ensure the normal transmission of the signal.

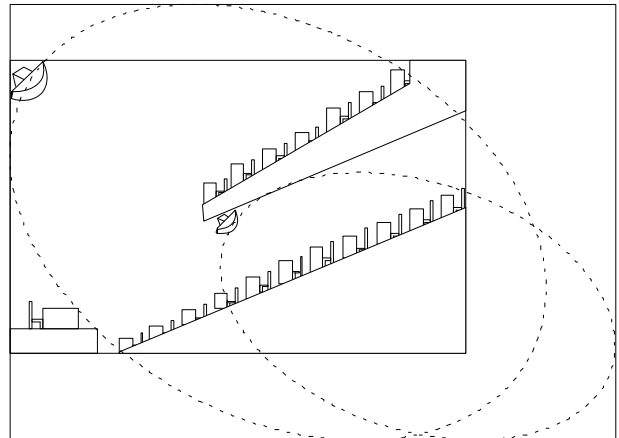

Fig. 3-3 “IR Coverage in “blind Area”

3.4.2 Wiring of the radiator

The signal's delay can be caused by the distance difference between the system transmitter to the different radiator. In order to avoid “blind spot” , please choose the cables that are of same length.

The cable delay can be compensated via the signal compensation button inside of the radiating panel.

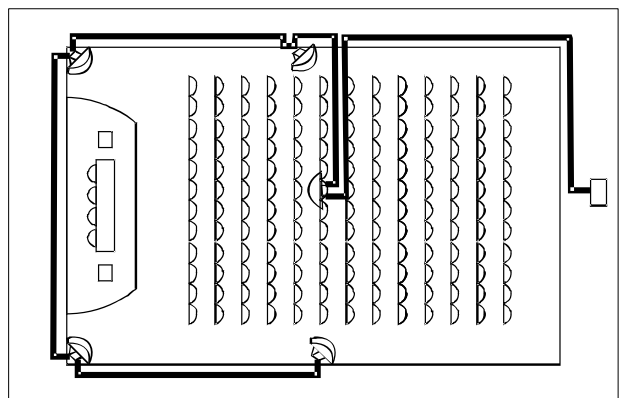

Fig.3-4 Non-symmetrical connection, should be avoided

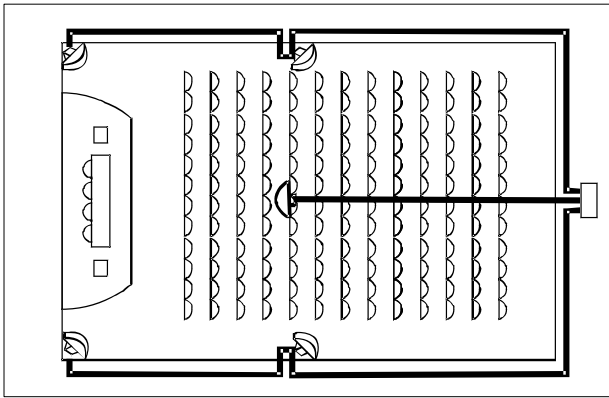

Fig. symmetrical connection (preferred)

3.4.3 Rectangle Coverage

The actual required number of the radiator can only be determined by field test, but using “rectangle coverage” can ensure a very close guess.

Fig.3-6 and Fig.3-7 explain what is the “rectangle coverage”, from which we can see that the rectangle coverage is smaller than the total coverage. Notice: in Fig.3-7, “deviation value” X is negative and the rectangle coverage is actually bigger than the actual coverage.

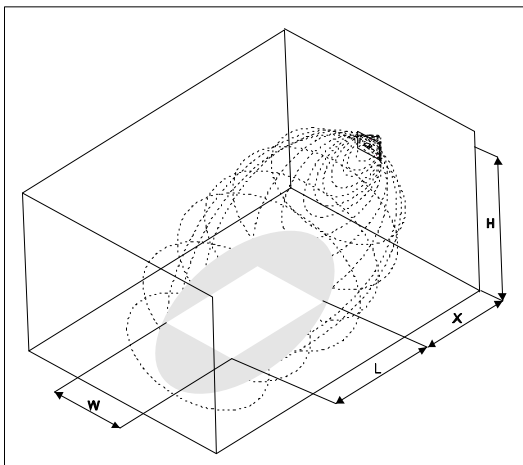

Fig.3-6 15° installation: typical rectangle coverage

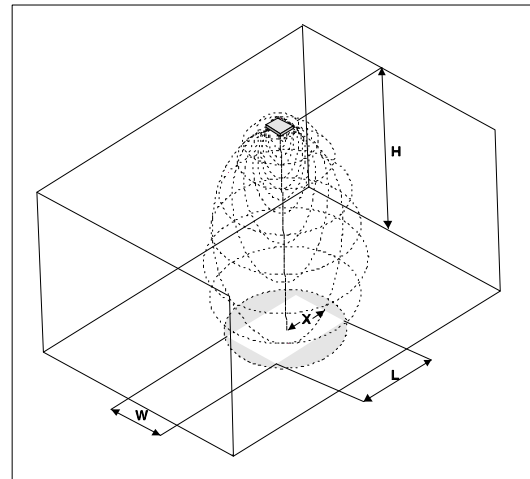

Fig. 3-7 90° installation's typical rectangle coverage

3.5 Installation steps of radiator

- ◆ Take the instructions mentioned in section 1.4 to decide the positions of the IR radiator
- ◆ Draw out the rectangle coverage in the layout draft of the room
- ◆ If there are some areas which can receive signal from two neighbor radiating panels, it means that there is eclipsing effects. Draw out the enlarged rectangle coverage in the layout draft.
- ◆ Check whether the radiator have full coverage to certain spots; and if not, extra radiator should be added.

3.6 Delay switch Settings

In section 1.4.6, there is “overlapping multi-path effect”: the receiver receive signal from two or more radiating panels, and “blind spots” can be caused due to delay difference.

In order to compensate the delay difference, the delay switch on the side of the radiator can be set to increase the corresponding panel's delay. The LCD can display from 00 to 99, and the digit is timed by 25ns, ie. The delay time can be set is from 25ns to 2475ns (99*25).

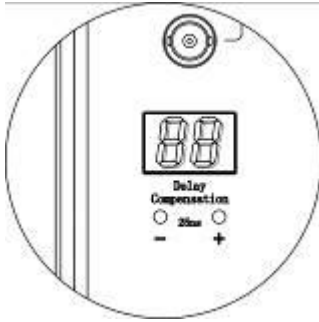

3.6.1 How to calculate the delay

When there is only one transmitter and all the radiator are connected to the transmitter with the cables that are of same length, there is no delay to be considered. Under this situation, all delay switches on all the radiator should be set as 00, and the need of delay signal should be confirmed.

Use the delay of the radiator whose distance to the transmitter is the farthest, and then use “+” and “-” to adjust the delay of the other radiating panels to make sure every radiator have the same delay.

$$\text{Formula: } X = \frac{(L_{\text{MAX}} - L) \times 5.6}{25}$$

- ◆ Cable delay coefficient 5.6ns/m;
- ◆ X: The displayed delay compensation factor
- ◆ $L_{\text{MAX}} - L$: The max distance (meter) between the transmitter and the radiator;
- ◆ L: the distance between the radiator land the transmitter(meter);

Follow the steps to measure the length of the cables to determine the settings of the delay switch:

- ◆ Measuring the cable length from the distribution host to each radiation board L;
- ◆ Make sure the maximum distance from the

distribution host to each radiation board L_{MAX} ;

- ◆ Calculate the difference from L to L_{MAX}
- ◆ Cable length with a calculated by multiplying the cable signal delay difference between the rate of radiation on each radiator can be drawn to the cable signal delay difference
- ◆ In addition to the signal delay in 25 poor, in addition to be an integer (rounded) radiator delay compensation switches to set parameters.
- ◆ If necessary, to overlapping coverage areas, away from the overlapping coverage area closer to the delay of radiator switch settings parameters do increase, as the radiation signal delay compensation
- ◆ In accordance with the calculated setting parameters to set the delay switch

3.7 Installation of the radiator

Infrared radiator can be installed on walls or ceiling, with the package with a mounting bracket and screws, install as shown below:

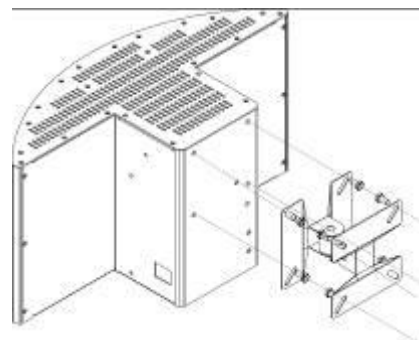

In determining the installation location before, need to ensure smooth airflow around the unit of radiation, radiator to avoid the phenomenon of high temperature.

3.8 Connection between the radiator and the transmitter

Automatic switching-on voltage level100mV Radiating signal Radiation distance.....76m

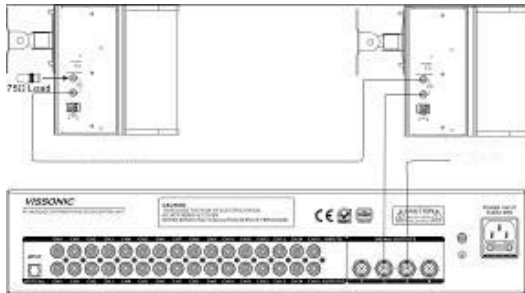

Attention: When cascading the radiator, the BNC connector of the last radiator in the cascading chain which is left unused should be connected to a load resistance of 75Ω in order to match the impedance to avoid signal reflex.

3.9 Controls and indicators

- ◆ Input signal indicated with the radiation LED
- ◆ Output power switch
- ◆ Delay compensation LCD
- ◆ Delay compensation buttons(-/+)

3.10 Interconnection

- ◆ HF input and output connectors(2 x BNC) for connection to transmitter and loop-through to other radiators

3.11 Specification

Electrical and optical

Modulation.....DQPSK, according to IEC61603-7
 Modulation frequency
 Carriers 0 to 5.....2 to 6 MHz, according to IEC 61603-7
 Carriers 6 to 7.....Up to 8 MHz
 Angle of half intensity.....± 25°
 HF input.....Nominal 1 Vpp,75 Ohm
 HF output.....1 Vpp,6V DC,75Ohm
 Power Supply.....100V-240V AC
 50/60Hz
 Max. Power.....36W
 Static Power.....3W

Chapter 4 Digital Infrared Receiver

4.1 Overview

Using the latest electronic technology, the use of specialized chips to ensure the best performance and longest battery life, according to ergonomic design of the infrared receiver to receive IR signals can be very good. With channel selection functions and volume level adjustment function, the power switch control, and battery power, signal indicator, when the receiver receives less than 5 minutes continuous signal or unplug the headphones will automatically shut down after 5 minutes.

VISSONIC produces two kinds of digital infrared receiver:

VIS-VLI703A-4	4 channels IR receiver
VIS-VLI703A-8	8 channels IR receiver
VIS-VLI703A-16	16 channels IR receiver
VIS-VLI703A-32	32 channels IR receiver

4.2 VIS-VLI703A-4/8/16/32 Description

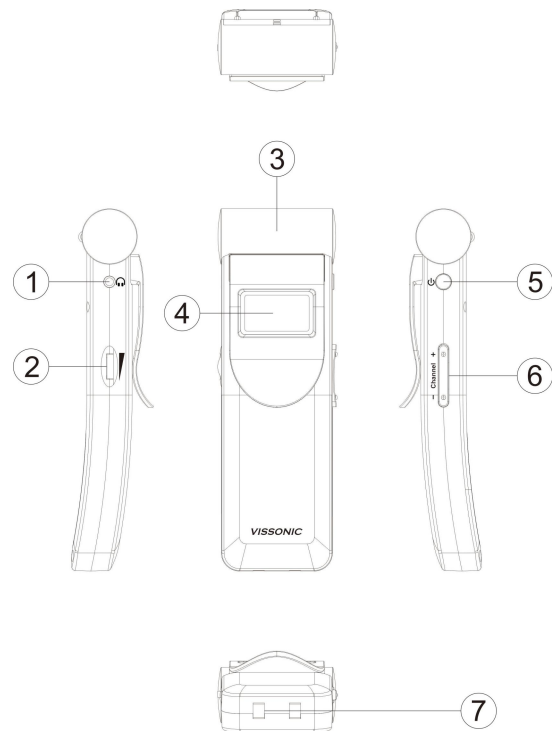

- ① Headphone jack
- ② Volume knob
- ③ Infrared receiving window
- ④ LCD screen to display the language name, channel number, signal intensity, volume level, battery level etc.
- ⑤ Power switch
- ⑥ Channel selector button
- ⑦ Charging contact

4.3 VIS-VLI703A-4/8/16/32 features

- Compliant to IEC 61603-7 and IEC 60914

- Compatible with any other IR simultaneous interpretation system compliant to IEC 61603-7
- Digital infrared processor with DQPSK digital modulation/demodulation technology
- Transmitting in 2~8 MHz frequency band eliminates disturbance from high frequency lighting systems
- Channel selection via up/down button, at most 4,8,16 or 32 channels available
- LCD display with channel number, language name, battery and signal status indication
- Number of available channels is always the same as the number of channels in use by the system, eliminating the need to scroll through unused channels
- Adjustable volume
- Unique 270° super wide reception angle, ensuring perfect sound quality even when casually placed
- Audio signal automatically muted when signal is too low, ensuring that the user receives only high quality audio.
- Ergonomically compact and elegant design
- Lightweight and handy receiver in conjunction with single earphone or headphone for easy and comfortable use
- Can be hung over the neck via a nice strap or fit into the shirt pocket
- Freedom of movement within the range of IR power radiator
- No limit to the receiver number within the IR power radiation range
- Works without errors, even in bright sunlight
- Built-in high precision rechargeable circuitry to prolong battery life
- Environmentally-friendly lithium rechargeable battery pack

- No power consumption and auto-off when headphone is disconnected after 5 minutes

4.4 Operations of the receiver

IR receiver can be plugged in headphones work, plug your headphones into the receiver's headphone jack, press the power switch button, LCD screen displays channel, using channel selection buttons "+" and "-" to select the desired channel to listen.

In the work, such as signal failure, the receiver will automatically mute on headphone output, not more than five minutes to receive infrared signals, the receiver automatically shut down, not consume electricity.

When the headset and the receiver is disconnected after 5 minutes did not plug headphones straight to receive will automatically shut down.

Receiver using disposable batteries environmentally-friendly rechargeable battery, the battery is installed, follow the instructions to install the polarity of the battery slot.

4.5 Controls and Indicators

◆ LCD displays channel number, language name, battery capacity, signal intensity and volume Power switch

◆ On/Off Button;

◆ Slider-type volume adjuster;

◆ Channel selector buttons;

4.6 Interconnections

◆ 3.5mm (0.14 inch) Headphone output jack

◆ Charging contacts

4.7 Specification

System Specifications

Modulation.....DQPSK, according to IEC 61603-7 Modulation frequency
 Carriers 0 to 5.....2 to 6 MHz, according to IEC 61603-7
 Frequency response.....20 Hz to 10 kHz (-3dB) at standard quality;
 20 Hz to 20 kHz (-3dB) at perfect quality
 THD at 1 KHz<0.05%
 Isolation.....>80 dB
 Dynamic range.....>80 dB
 Weighted SNR.....>80 dBA
 Input range.....-12 dBV ~ +12 dBV (adjustable)

Electrical

IR irradiance level.....4 mW/m² per carrier
 Angle of sensitivity.....270°
 Headphone output level at 2.4 V 450 mVrms (speech at maximum volume, 32 Ohm headphone)

Headphone output freq. range.....20 Hz to 20 kHz
 Headphone output impedance.....32 Ohm to 2 kOhm
 Max. SNR.....>80 dBA
 Supply voltage.....3V to 4.2V, nominal 3.7 V
 Headphone jack unplugged after 5 minutes.....0 mA Battery life
 Rechargeable battery pack24 hours

Mechanical

Dimensions (H x W x D)159 x 49 x 23 mm
 Weight..... excluding battery 85 g including battery 128g (0.27 lb)
 Color.....black with silver

Chapter 5 Interpreter Unit

The VIS-INT64 interpreter unit is a fully functional translation unit, which can carry 63+1 languages simultaneously, and realize the direct translation and indirect translation of these languages.

4.8 Features

- Digital audio technology, built-in high-speed DSP processing.
- Accommodates up to 64 interpretation channels (incl. floor channel)
- No limit quantity of interpreter units in the system
- Digital audio technology, built-in high-speed DSP processing.
- Supporting 48 kHz audio sampling rate, 30 Hz to 20 kHz frequency response on all 64 channels
- Anti-interference by any RF signal with metal housing design.
- Hot plug and play
- Removable microphone design
- The volume of Loudspeaker and earphone jack support separated adjustment.
- Direct and relay interpretation available
- Hearing protection direct and relay interpretation available
- Interpreter unit can be set as operation unit and all interpreter units support Internal communication with operator unit
- Language and system configuration from the interpreter desk's configuration menu
- Short message and tea service function
- COUGH key to mute the MIC to avoid the unnecessary sound to the output
- With two groups of the headset microphone and earphone jacks for two interpreters working on the interpreter unit
- The speaker and the headset's volume should be regulated alone. If all microphones in the same booth are off, the loudspeaker will play floor language or interpretation channel

- Support the headset microphone and pluggable microphone.
- Channel interlock function permits only one microphone on a channel to be activated at any time, ensuring the uniqueness of language channels
- Two necessary modes within one interpreter booth: Interlock and Override
- A-B pre-select input key to quickly select Input channel
- a-b pre-select input key to quickly select output channel
- The timing function for indicating the interpretation time.
- Translation unit number almost unlimited.

4.10 Description

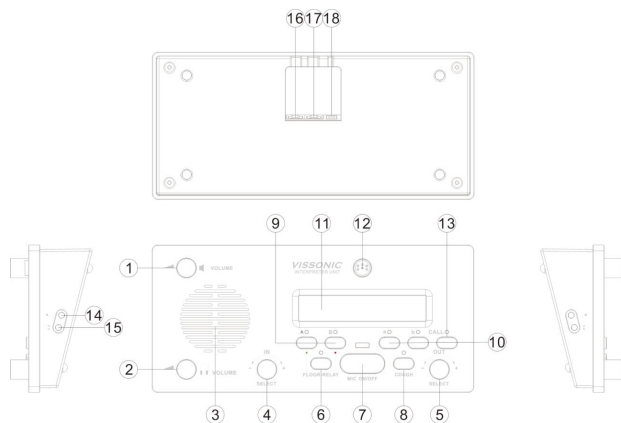

- ① Speaker volume control knob.
- ② the headphones volume knob.
- ③ built-in speakers.
- ④ IN - input channel selection knob.
- ⑤ OUT - Output channel selection knob.
- ⑥ FLOOR- RELAY - Sounds and indirect translation switch.
- ⑦ MIC ON/OFF-- microphone switch.
- ⑧ COUGH - cough elimination button. Press and hold in translation status, a temporary interruption to prevent cough being passed, release to return to normal translation.
- ⑨ A, B –input channel shortcuts. Select an input channel and press A or B button for 3 seconds, the button becomes the channel shortcut key, you can quickly select input channel.

- ⑩ a, b, - output channel shortcuts. Select an output channel, long press a or b for 3 seconds, the button becomes the shortcut key, you can quickly select output channel.
- ⑪ LCD display - Resolution 320X64, the left shows the input channel number and multilingual information. The right displays output channel number and multilingual information.
- ⑫ Microphone jack.
- ⑬ CALL - multi-function button. Long press this button to enter setup mode interface. You can set the corresponding relations of languages and
- ⑭ Microphone jack.
- ⑮ Headphone jack.
- ⑯ CU/DU
- ⑰ CU/DU
- ⑱ Power input-48VDC

4.11 Descriptions of panel display

display

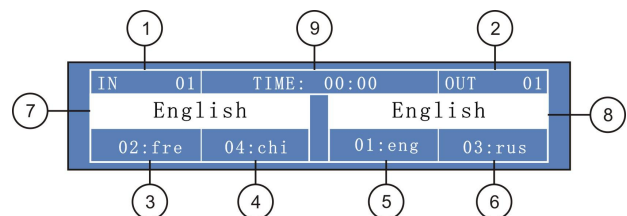

- ① input channel indication.
- ② output channel instructions.
- ③the channel and multilingual instructions corresponding to input channel shortcut key A.
- ④the channel and multilingual instructions corresponding to input channel shortcut key B
- ⑤the channel and multilingual instructions corresponding to output channel shortcut key a.
- ⑥the channel and multilingual instructions

corresponding to output channel shortcut key b .

⑦ input channels languages .

⑧ output channels languages.

⑨ speech timing, maximum timing for 99 minutes 59 seconds long.

Services:

In the conference mode, press the number key"CALL" button to enter the service menu,

which can offer language switch, intercom, tea applications and viewing the short message

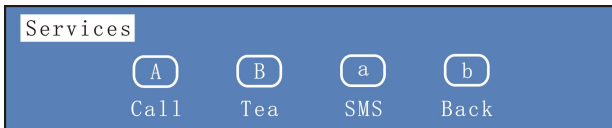

Press "A" key, enter internal call.

Press "B" key to enter the tea applications.

Press "a" key to view short messages.

Press "b" key to return to the previous menu.

4.12 Operator

Translation unit can be set to the operator unit, for the convenience of intercom management.

Translation unit is set to operator as follows:

Before power translation unit, press and hold the translation unit "CALL" button, release the button until operator set, translation unit is set to operator. The operator can be set to translation unit in the same way.

Operator is usually installed in management room to monitor conference translation channels, true voice, the whole hall intercom.

Operator LCD displays as follows:

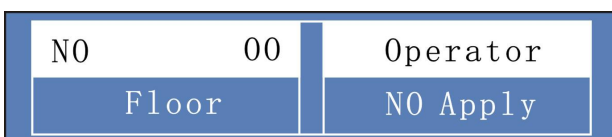

When internal calls applies, the operator

translation unit LCD display shows as below

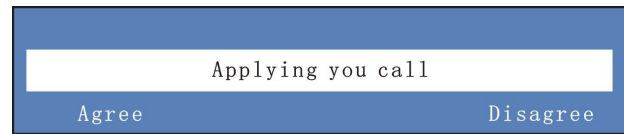

Press "Agree" button, the call begins, the LCD display shows as below:

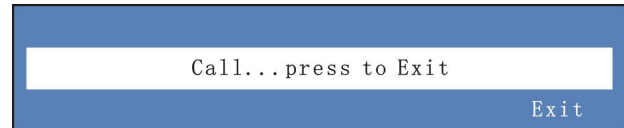

Press "EXit" button to finish the call and quit,

4.13 Specification

Electrical

Power..... DC48V from main unit or adaptor

Power consumption.....3W

Microphone

TransducerElectret-condenser

Polar pattern.....Uni-directional

Sensitivity.....-46dBV/pa

Frequency response.....20Hz~20KHz

Input impedance.....2.2kOhm

Earphone

Frequency Response.....30~20KHZ

Earphone load.....>8ohm

Earphone volume.....10mW

Directivity 0°/180°> 20 dB (1 kHz)

Equivalent noise20 dBA (SPL)

Maximum sound pressure level.....125 dB (THD<3%)

Interface

Display.....320x64 dot (blue white)

Connector.....2 x Ø 3.5 mm earphone jack, 2 x Ø 3.5 mm Microphone jack,2xRJ45 port,1x2.5mm adapter port

Mechanical

Dimension h x w x d

(mm).....280X128X55

Weight.....1.5kg

Color.....Black

Chapter 5 Accessories

5.1 VIS-TC50A Charger and Storage Box

VIS-TC50A Charger and Storage Box support not only charging function, but also can be used to store infrared receiver, using special design, when the receiver stored in the charging box, move, or shake the box the receiver will not be affected.

When the receiver is plugged into the slot of charger, the red LED indicator in the infrared window of receiver is going to flashing(charging) or static lighting(The battery is full).The LCD on the receiver show the charging status on charging or batter full status.

Charger and Storage Box

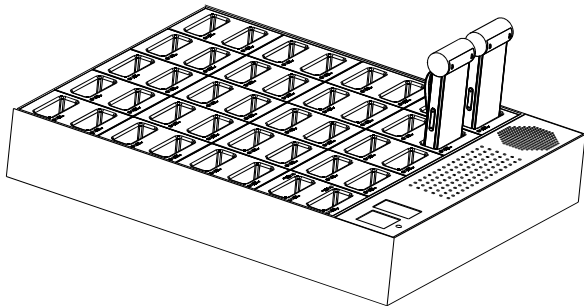

Features

- ◆ Can accommodate VIS-VLI703A series receivers
- ◆ Universal mains power facility allows use worldwide
- ◆ Rapid recharging: within 2 hours
- ◆ Capable of charging 50 receivers.
- ◆ LEDs to indicate the charging status of the rechargeable batteries
- ◆ The charging box also has the function of storing receiver

Controllers and indicators

- ◆ On/Off switch

Interconnection

- ◆ Electric power supply in series Interface: European type, Yang-style socket
- ◆ 50 Charge contacts.

Specification

Electrical

Power..... 100V-240V AC
 Max. Power.....200W
 Static Power.....17W (no charging)

Mechanical

Dimension h x w x d
 (mm).....112x494x395
 Weight.....5kg
 Color.....Black

5.2 VIS-BTPS Battery Pack

The large-capacity rechargeable battery pack provides a continuous and stable power supply for the all-digital infrared receiving unit, ensuring uninterrupted operation for a long time.



Specification

Material lithium battery pack
 Voltage 3.7V
 Capacity 1600mAh
 Dimensions Width × Depth × Height
 (mm) 48 × 29 × 15
 Weight 45 g

5.3 VIS-HPI Interpreter Headset

The bilateral head-mounted wheat earphones are light and exquisite in shape, which makes the user feel comfortable. The headphone is used with the interpreter unit and is used for sound monitoring and speaking.



Technical Parameters

Wearing style
 Frequency range..... 20Hz – 2KHz
 Impedance32 Ω ± 15% Ω
 Plug size3.5mm
 Sensitivity105dB ± 3dB
 cable length..... 2.2mm

5.4 VIS-HPD Conference Headphone

The conference headphone can be used for the conference unit/simultaneous receiver for monitoring, high-fidelity sound quality. With a 1.5 meter long

connection, the channel response has reached 30HZ-16KHZ



Technical Parameters

Unit interface..... 2-channel plug
 Frequency response 80Hz – 2KHz
 Sensitivity..... 90dB
 Signal to noise ratio..... > 80dB
 Distortion < 0.1dB
 Impedance..... 32 Ω
 Dynamic range > 85 dB
 Output power 100mW

Chapter 6 Frequently seen malfunction and maintenance

1、 Host power indicator does not light

Check the power switch is closed, equipment power input is a good contact.

A: switching power supply there are two key characters, a "O" and "I" word, when the "O" word side of subsidence, "I" word side of the upturned, on behalf of the unit is turned off, and vice versa are turned on.

B: Check whether the connections are secure socket connection, or disconnect the power cord from the new re-plug in to determine the connection properly.

2、 when the plug serial port or connection cable interface, a significant electrostatic

Possible without a good grounding equipment power ground, press the correct way to ground, otherwise easily damage the system, reducing the host life.

A: due to the host using a 100-240V switching power supply, the better to prevent static electricity, attention must use a grounded three-core power cable, do not use the two-core power cable.

B: Check the local power outlet ground terminal is a good grounding.

3、Radiation panel indicator does not light

Please check the power cord is connected properly with the radiation panel.

4、Receiver abnormal working

A: If you use the battery, check battery is sufficient, if installed correctly.

B: If you use rechargeable batteries, check whether the charge to saturation.

C: Check the headset and the receiver is connected properly.

D: Check whether the receiver can receive the infrared signal of sufficient strength.

E: Check the volume is turned on, and opened to the maximum volume.

F: Please avoid direct rays of the receiver with a strong light, such as: not blasting dew in the sunlight.

G: If the receiver with noise or sound is distorted, adjust the receiver and the radiation panel or adjust the distance between the receipt of direction.

5、When Receiver charging

When the receiver into the charging box VIS-VLI703-8/16 when the receiver was red and green lights flashing, please check the contacts on the receiver contact with the charger is good contact, back into the fixed, to be directed flashing red light when the state, the receiver is in charge state.

The same time, charging indicator light does not shine, need to check the receiver inside the battery is installed properly.

Receiver needs to check whether the temperature anomaly.