

USER MANUAL

ProLite

LCD Monitor

ENGLISH

ProLite TF6539UHSC

Thank you very much for choosing the iiyama LCD monitor.

We recommend that you take a few minutes to read this comprehensive manual carefully before installing and switching on the monitor. Please keep this manual in a safe place for your future reference.

CE MARKING DECLARATION OF CONFORMITY

This LCD monitor complies with the requirements of the EC/EU Directive 2014/30/EU "EMC Directive", 2014/35/EU "Low Voltage Directive", 2009/125/EC "ErP Directive" and 2011/65/EU "RoHS Directive".

Warning

This is a class A product. In a domestic environment this product may cause radio interference in which case the user may be required to take adequate measures.

IYAMA CORPORATION: Wijkermeerstraat 8, 2131 HA Hoofddorp, The Netherlands

Model No. : PLT6539



We recommend recycling of used product. Please contact your dealer or iiyama service center. Recycle information is obtained via the Internet, using the address: <http://www.iiyama.com>

You can access the Web page of different countries from there.

- We reserve the right to change specifications without notice.
- All trademarks used in this user manual are the property of their respective owners.
- Eprel registration number TF6539UHSC-B1AG : 392478

TABLE OF CONTENTS

FOR YOUR SAFETY.....	1
SAFETY PRECAUTIONS.....	1
SPECIAL NOTES ON LCD MONITORS	3
CUSTOMER SERVICE	5
CLEANING	5
BEFORE YOU OPERATE THE MONITOR.....	6
FEATURES.....	6
CHECKING THE CONTENTS OF THE PACKAGE	6
SPECIAL NOTES ON TOUCH PANEL.....	7
CONTROLS AND CONNECTORS.....	8
INSTALLATION	10
BASIC OPERATION.....	12
CONNECTING YOUR MONITOR.....	14
COMPUTER SETTING	16
OPERATING THE MONITOR.....	19
ADJUSTMENT MENU CONTENTS.....	21
SCREEN ADJUSTMENTS	26
STANDBY FEATURE	29
TROUBLE SHOOTING	30
RECYCLING INFORMATION.....	31
APPENDIX	32
SPECIFICATIONS : ProLite TF6539UHSC-B1AG	32
DIMENSIONS : ProLite TF6539UHSC-B1AG	33
COMPLIANT TIMING	34

FOR YOUR SAFETY

SAFETY PRECAUTIONS

WARNING

STOP OPERATING THE MONITOR WHEN YOU SENSE TROUBLE

If you notice any abnormal phenomena such as smoke, strange sounds or fumes, unplug the monitor and contact your dealer or iiyama service center immediately. Further use may be dangerous and can cause fire or electric shock.

NEVER REMOVE THE CABINET

High voltage circuits are inside the monitor. Removing the cabinet may expose you to the danger of fire or electric shock.

DO NOT PUT ANY OBJECT INTO THE MONITOR

Do not put any solid objects or liquids such as water into the monitor. In case of an accident, unplug your monitor immediately and contact your dealer or iiyama service center. Using the monitor with any object inside may cause fire, electric shock or damage.

INSTALL THE MONITOR ON A FLAT, STABLE SURFACE

The monitor may cause an injury if it falls or is dropped.

DO NOT USE THE MONITOR NEAR WATER

Do not use where water may be splashed or spilt onto the monitor as it may cause fire or electric shock.

OPERATE UNDER THE SPECIFIED POWER SUPPLY

Be sure to operate the monitor only with the specified power supply. Use of an incorrect voltage will cause malfunction and may cause fire or electric shock.

PROTECT THE CABLES

Do not pull or bend the power cable and signal cable. Do not place the monitor or any other heavy objects on the cables. If damaged, the cables may cause fire or electric shock.

ADVERSE WEATHER CONDITIONS

It is advisable not to operate the monitor during a heavy thunder storm as the continual breaks in power may cause malfunction. It is also advised not to touch the plug in these circumstances as it may cause electric shock.

CAUTION

INSTALLATION LOCATION

Do not install the monitor where sudden temperature changes may occur, or in humid, dusty or smoky areas as it may cause fire, electric shock or damage. You should also avoid areas where the sun shines directly on the monitor.

DO NOT PLACE THE MONITOR IN A HAZARDOUS POSITION

The monitor may topple and cause injury if not suitably located. Please also ensure that you do not place any heavy objects on the monitor, and that all cables are routed such that children may not pull the cables and possibly cause injury.

MAINTAIN GOOD VENTILATION

Ventilation slots are provided to keep the monitor from overheating. Covering the slots may cause fire. To allow adequate air circulation, place the monitor at least 10 cm (or 4 inches) from any walls. In case the monitor will be installed inside a kiosk or any other equipment, please make sure enough ventilation is available to avoid overheating of the monitor. Contact the iiyama service center in case you need advice.

DISCONNECT THE CABLES WHEN YOU MOVE THE MONITOR

When you move the monitor, turn off the power switch, unplug the monitor and be sure the signal cable is disconnected. If you do not disconnect them, it may cause fire or electric shock.

UNPLUG THE MONITOR

If the monitor is not in use for a long period of time it is recommended that it is left unplugged to avoid accidents.

HOLD THE PLUG WHEN DISCONNECTING

To disconnect the power cable or signal cable, always pull it by the plug. Never pull on the cable itself as this may cause fire or electric shock.

DO NOT TOUCH THE PLUG WITH WET HANDS

Pulling or inserting the plug with wet hands may cause electric shock.

WHEN YOU INSTALL THE MONITOR ON YOUR COMPUTER

Be sure the computer is strong enough to hold the weight of the monitor, otherwise, you may damage your computer.

OTHERS

ERGONOMIC RECOMMENDATIONS

To eliminate eye fatigue, do not operate the monitor against a bright background or in a dark room. For optimal viewing comfort, the monitor should be just below eye level and 40-60 cm (16-24 inches) away from your eyes. When using the monitor over a prolonged time, a ten minute break every hour is recommended as looking at the screen continuously can cause eye strain.

SPECIAL NOTES ON LCD MONITORS

- The following symptoms are normal with LCD monitors and do not indicate a problem.

NOTE

- When you first turn on the LCD monitor, the picture may not fit in the display area because of the type of computer that is used. In this case, adjust the picture position to the correct position.
- You may find slightly uneven brightness on the screen depending on the desktop pattern you use.
- Due to the nature of the LCD screen, an afterimage of the previous screen may remain after switching the image, when the same image is displayed for hours. In this case, the screen is recovered slowly by changing the image or turning off the Power Switch for hours.

- This LCD cannot be used outdoors.
- If you use a cable longer than the supplied one, the picture quality is not guaranteed. Touch function can be disrupted if the USB cable length exceeds 3m.

USAGE CONFIRMATION

This product is designed for optimum usage at 24hours per day.

The monitor is compatible for usage in Landscape/Portrait and Tabletop (face-up) applications. If being used in Tabletop application, please utilise the Fan-on function.

IMAGE PERSISTENCE / IMAGE STICKING

Please be aware that all LCD screens can experience Image Persistence or Image Sticking. This occurs when a residual image remains visible on a screen when static images are displayed for long periods of time. LCD Image Persistence is not permanent but constant images being displayed for a long period of time should be avoided.

To counteract Image Persistence, turn off the monitor for as long as the previous image was displayed, so if an image was on the monitor for 1 hour and there is evidence of a residual or “ghost” image, you should turn off the monitor for 1 hour in order to clear the residual image.

For all LFD products, iiyama recommends displaying moving images and utilising a moving screen saver at regular intervals whenever the screen is idle. You could also turn off the monitor when not in use to assist the prevention.

Other ways to reduce the risk of Image Persistence will be to utilise the FAN-on function (if available), Low Backlight and Low Brightness settings.

FOR EXTENDED USE AS A PUBLIC DISPLAY

■ Image Sticking on LCD Panel

When a static image is displayed for hours, an electric charge trace remains near the electrode inside the LCD producing a “ghost” image. (Image Persistence).

Image Persistence is not a permanent feature.

■ Recommendations

To prevent Image Sticking and promote longer life expectancy of display, we recommend the following:

1. Avoid static images displayed for long periods – change static images on continuous loop.
2. Turn off the monitor when not in use, use either Standby or Schedule functions.
3. When monitor is installed in high ambient temperature environment(s) or in an enclosed position, utilise the Cooling Fan, Screen Saver and Low Brightness functions.
4. Suitable ventilation for any monitor is an expectation of any installation – climate control systems may need to be employed.
5. We strongly recommend utilisation of active cooling with fans for long operation times or high ambient temperature environments.

CUSTOMER SERVICE

NOTE

- If you have to return your unit for service and the original packaging has been discarded, please contact your dealer or iiyama service center for advice or replacement packaging.

CLEANING

WARNING

- If you drop any materials or liquids such as water into the monitor when cleaning, unplug the power cable immediately and contact your dealer or iiyama service center.

CAUTION

- For safety reasons, turn off the power switch and unplug the monitor before you clean it.

NOTE

- To protect the LCD panel, do not scratch or rub the screen with a hard object.
- Never use any of the following strong solvents. These will damage the cabinet and the LCD screen.

Thinner	Benzine	Abrasive cleaner
Spray-type cleaner	Wax	Acid or Alkaline solvent

- Touching the cabinet with any product made from rubber or plastic for a long time may cause degeneration or loss of paint on the cabinet.

CABINET

Stains can be removed with a cloth lightly moistened with a mild detergent solvent. Then wipe the cabinet with a soft dry cloth.

LCD

Periodic cleaning with a soft dry cloth is recommended.

SCREEN

Don't use tissue paper etc. because these will damage the LCD screen.

BEFORE YOU OPERATE THE MONITOR

FEATURES

- ◆ Supports Resolutions up to 3840 × 2160
- ◆ High Contrast 1100:1 (Typical) / Brightness 500cd/m² (Typical)
- ◆ Digital Character Smoothing
- ◆ Automatic Set-up
- ◆ 2 × 8W Stereo Speakers
- ◆ Standby Feature (VESA DPMS Compliant)
- ◆ VESA Mounting Standard (600mm×400mm) Compliant
- ◆ Glass with AG coating

CHECKING THE CONTENTS OF THE PACKAGE

The following accessories are included in your package. Check to see if they are enclosed with the monitor. If anything is missing or damaged, please contact your local iiyama dealer or regional iiyama office.

- | | | |
|----------------|---------------------|---------------------|
| ■ Power Cable* | ■ HDMI Cable | ■ DisplayPort Cable |
| ■ USB Cable | ■ Clamper (3pcs) | ■ Cable Cover |
| ■ Safety Guide | ■ Quick Start Guide | |

CAUTION * The rating of the Power Cable enclosed in 120V area is 10A/125V. If you are using a power supply higher than this rating, then a power cable with a rating of 10A/250V must be used. However, all guarantees and warranties are void for any problems or damage caused by a power cable not supplied by iiyama. An approved power cable greater or equal to H05VVf, 3G, 0.75mm² must be used.

SPECIAL NOTES ON TOUCH PANEL

CAUTION

Permanent damage can occur if Sharp Edged, Pointed or Metal items are used to activate Touch. This could invalidate any remaining warranty.

We recommend to use conductive rubber tip type stylus (tip R8.0 or over) or finger.

CONTROLS AND CONNECTORS

ENGLISH



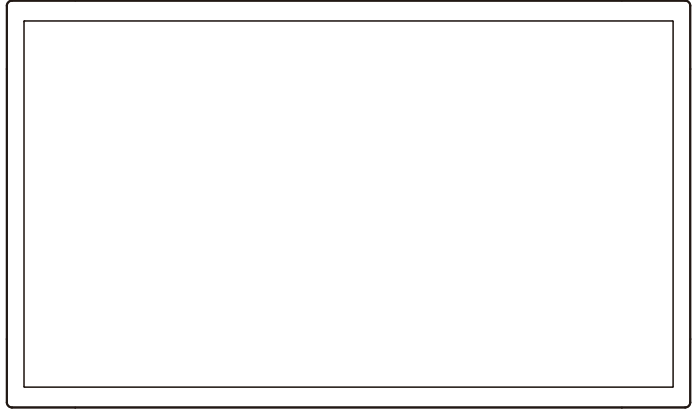

<Front>

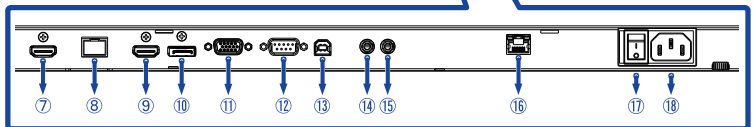
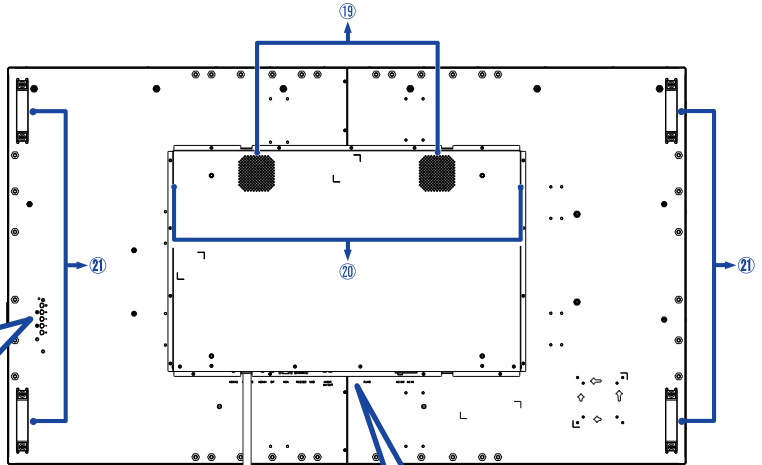
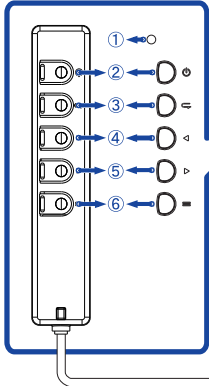

<Back>

*1 Remote Control OSD Key (option)



①	Power Indicator	Green	Normal operation
		Orange	Standby mode
②		Power Button	
③		Exit / Back Button	
④		Down / Left Button	
⑤		Up / Right Button	
⑥		Enter Button	
⑦	HDMI 2	HDMI	HDMI Connector
⑧	REMOTE KEY	RJ45	Connector for Remote Control OSD Key *1
⑨	HDMI 1	HDMI	HDMI Connector
⑩	DP	DisplayPort	DisplayPort Connector
⑪	VGA	VGA	VGA Connector
⑫	RS232C	RS232C	RS232C Connector
⑬	USB	USB Touch	USB Connector
⑭	AUDIO IN	Mini Jack	Audio Input Connector
⑮	AUDIO OUT *2	Mini Jack	Headphone Connector
⑯	RJ45	RJ45	RJ45 Connector
⑰	AC-SW (ON) / ○ (OFF)		Main Power Switch
⑱	AC IN	AC Inlet	AC Connector (~ : Alternating current)
⑲	Fans		
⑳	Speakers		
㉑	Handles		

*1 Remote Control OSD Key is option.

*2 Available for HDMI and DisplayPort inputs only.

INSTALLATION

CAUTION

- Follow the manual instructions for the type of mount you have selected. Refer all servicing to qualified service personnel.
- Moving the monitor requires at least two people.
- Before installation, please make sure the wall is strong enough to hold the necessary weight of the monitor and the mount.

[WALL MOUNTING]

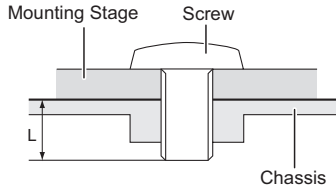

CAUTION

When using the wall mounting, consideration of thickness of the mounting stage needs to be taken. Tighten the M6 Screws (4pcs) with washer which "L" length is 10mm to fasten the monitor. Using a screw longer than this may cause electric shock or damage because it may contact with the electrical parts inside the monitor.

[FAN]

CAUTION

If the screen is used in face-up position, please be sure to turn on the FAN function. If you do not use the FAN, the internal temperature rises and the product life cycle may get shorter. If the screen is built into an external cabinet, please be sure to implement a cooling unit inside of the cabinet. Dirt and dust may stick to the FAN, reducing the cooling effect which may result in a shorter life cycle of the product. Please clean regularly.

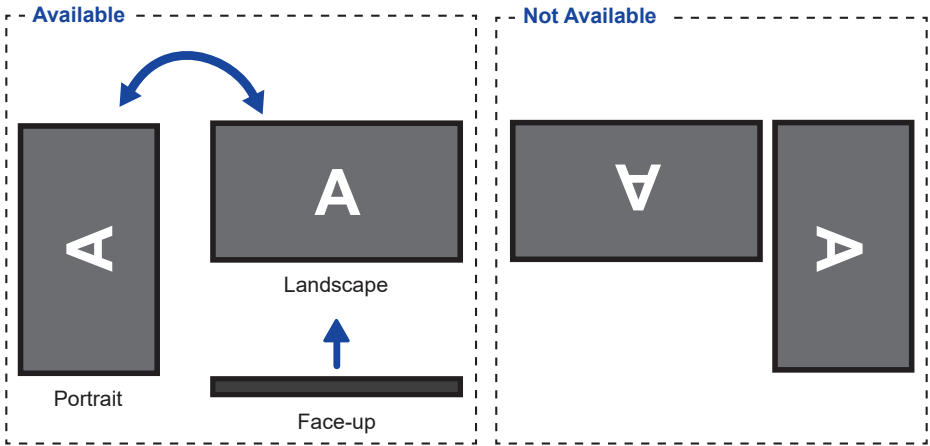

[ROTATING THE MONITOR]

This monitor is designed to be compatible in landscape, portrait and face-up modes.



BASIC OPERATION

■ Turning the monitor ON



The monitor is turned On and the Power Indicator turns to Green when you press the  (Power) Button. The monitor is turned Off and the Power Indicator turns to Orange when you press the  Button again.

NOTE

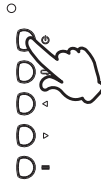
Even when using the standby mode or turning OFF the Main Power Switch, the monitor will consume a small amount of electricity. Disconnect the Power Cable from the power source whenever the monitor is not in use or during the night, to avoid unnecessary power consumption.



■ Display the adjustment menu page

The menu page appears on the screen when you press the  (Enter) Button.
The menu page disappears when you press the  (Exit) Button.

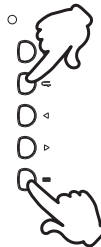

■ Move the cursor vertically

Select adjustment by pressing the  /  Buttons while the menu page is displayed on the screen.



■ Move the cursor horizontally

Select menu or setting, or perform the adjustment by pressing the ◀/▶ Buttons while the menu page is displayed on the screen.



■ Adjust the volume of sound

Press the ◀/▶ Buttons to adjust the volume of sound when the menu page is not displayed on the screen.

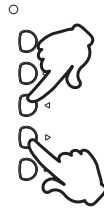

■ Switch the input signal

Press the ⇐ Button to display the Input signal menu when the menu page is not displayed on the screen. Press the ◀/▶ Buttons or the ⇐ Button to switch the Input signal.



CONNECTING YOUR MONITOR

- ① Ensure that both the computer and the monitor are switched off.
- ② Connect the computer to the monitor with the signal cable.
- ③ Connect the computer to the monitor with the USB Cable.
- ④ Connect the Remote Control OSD Key (option) to the monitor, if necessary.
- ⑤ Connect the Power Cable to the monitor first and then to the power source.
- ⑥ Turn on your monitor (Main Power Switch and Power Button) and computer.

NOTE

- Make sure that the building installation has a circuit breaker of 120/240V, 20A (maximum).
- The signal cables used for connecting the computer and monitor may vary with the type of computer used. An incorrect connection may cause serious damage to both the monitor and the computer. The cable supplied with the monitor is for a standard connector. If a special cable is required please contact your local iiyama dealer or regional iiyama office.
- Make sure you tighten the finger screws at each end of the Signal Cable.
- The touch function is ready for use about 8 seconds after connecting the USB cable and can be operated with a pen, finger or any other pointer.
- The Class I pluggable equipment Type A must be connected to protective earth. (By means of a power cable connected to a socket-outlet with earthing connection)
- The socket-outlet shall be installed near the equipment and shall be easily accessible.
- Excessive sound pressure from ear-/headphones can cause hearing damage/hearing loss.

[Example of Connection]

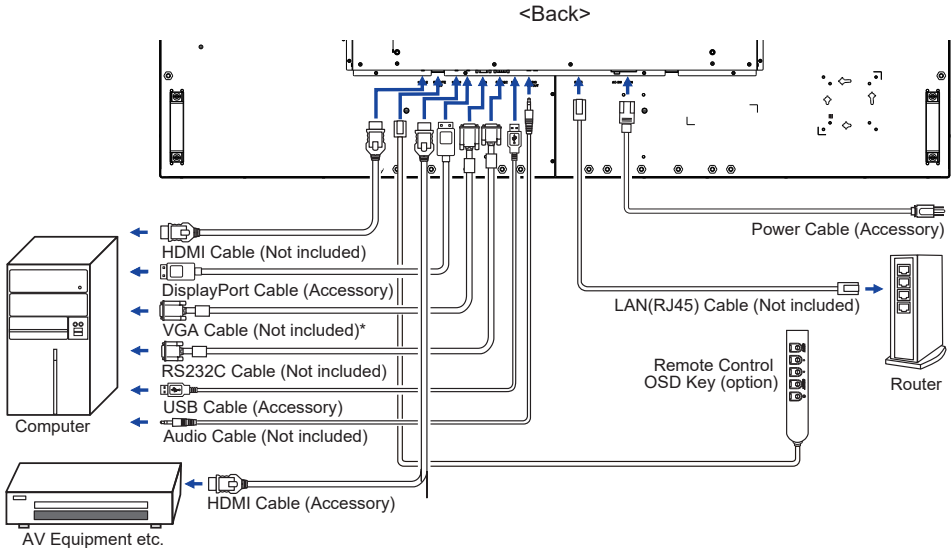

* VGA Cable is not supplied with the monitor. If you use low quality VGA Cable, it may cause a result of electro-magnetic interference. Please contact the iiyama Support Centre in your country if you wish to connect the monitor via the VGA input.

[Network Connection]

● Connecting to a LAN

To set the monitor to connect to a local area network.

1. Connect a RJ45 cable to the corresponding ports on the monitor and your LAN switch or router.
2. Enter the OSD menu Setting > Control Setting. Select LAN.
3. Enter the next OSD menu Setting > Network Settings > IP Address DHCP or Manual

<Input IP, ID and Password>

IP: 192.168.0.1

ID: Admin

Password: Admin12345

Setup

- If you are in a DHCP environment, highlight Auto Setup and select On. Once done, the IP Address, Subnet Mask, Default Gateway, and Primary DNS settings will be displayed.
- If you are not in a DHCP environment, highlight Auto Setup and select Off. Contact your ITS administrator for information on the IP Address, Subnet Mask, Default Gateway, and Primary DNS settings and enter it accordingly.

● Controlling the Monitor

Once you have the correct IP Address for your monitor and the monitor is on or in standby mode, you can use any computer that is on the same local area network to control the monitor.

- NOTE**
- You can not control the monitor via the RS-232C connector when LAN control is in use.
 - It is recommended that you use Google Chrome versions 51.0.2704.103 or higher browser.

1. Enter the IP Address of the monitor in the address bar of your browser and press ENTER button.
2. The setting page appears.

INFORMATION / PICTURE&SOUND / SCREEN / SETTING / SCHEDULE / NETWORK

Network Control

INFORMATION	PICTURE & SOUND	SCREEN	SETTING	SCHEDULE	NETWORK
Information					
Display					
Model Name:	RX-32				
Serial Number:	DSDMYXXXXXPP0				
Status					
Power Status:	Power On				
Video Source:	DVI				
Network					
IP Address:	192.168.1.202				
Subnet Mask:	255.255.255.0				
Gateway:	192.168.1.1				
Primary DNS:	192.168.1.1				
Secondary DNS:	0.0.0.0				
MAC Address:	44:37:E6:64:04:50				
Other Information					
Scaler F/W Version:	1.04				
Lan F/W Version:	1.05 Rev6				
Operation Time:	0000122 H				

COMPUTER SETTING

■ Signal Timing

Change to the desired signal timing listed on page 34: COMPLIANT TIMING.

■ Windows XP/Vista/8/8.1/10 Plug & Play

The iiyama LCD monitor complies with DDC2B of VESA standard. The Plug & Play function runs on Windows XP/Vista/8/8.1/10 by connecting the monitor to DDC2B compliant computer with the Signal Cable supplied.

For installation on Windows XP: The monitor Information File for iiyama monitors may be necessary for your computer and obtained via the Internet, using the address:

<http://www.iiyama.com>

NOTE

- For additional information on how to download the driver for your touch screen monitor, please access the internet site noted above.
- Monitor Drivers are not required in most cases for Macintosh or Unix operating systems. For further information, please contact your computer dealer first for advice.

■ Procedure for turning ON the Power Switch

Turn ON the monitor first, and then the computer.

■ MULTI-TOUCH :

This monitor complies with DDC2B of VESA standard. (Plug&play compliant)

The MULTI-TOUCH function runs on Windows 8/8.1/10 by connecting the monitor to DDC2B compliant computer with the USB cable supplied.

■ TOUCH support operation system :

OS Version (Windows)	Windows		
	Win 10	Win 8	XP
Supported touches	multi-touch		
Note	Windows inbox driver (No Need SiS driver)		Single-touch

OS Version (Linux Distribution)	Android				Linux
	7.0	6.0	5.0 ~ 5.1	4.0 ~ 4.4	
Supported touches	multi-touch				
Supported Kernel version	4.4	3.18	3.0~3.14		3.0~4.4
Note	Driver supports multi-touch				

OS Version (Mac OS)	Mac OS			
	10.9 (Mavericks)	10.10 (Yosemite)	10.11 (El Capitan)	10.12 (Sierra) 10.13 (High Sierra)
Supported touches	Single-touch			
Note	Similar to Apple Trackpad gesture: 2-finger gesture: zoom in/out, swipe 4-finger gesture: show desktop	Similar to Apple Trackpad gesture: 2-finger gesture: zoom in/out, swipe 4-finger gesture: show desktop Our service team provides you with the driver and the operation guide.	Similar to Apple Trackpad gesture: 2-finger gesture: zoom in/out, swipe 4-finger gesture: show desktop Our service team provides you with the driver and the operation guide.	Our service team provides you with the driver and the operation guide.

■ Touch Input Settings in Dual Screen Mode

① Connect the primary monitor to the computer first.

Set Control Panel > Hardware and Sound > Tablet PC Settings > Display > Setup.

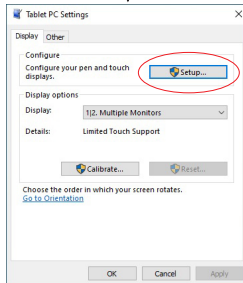
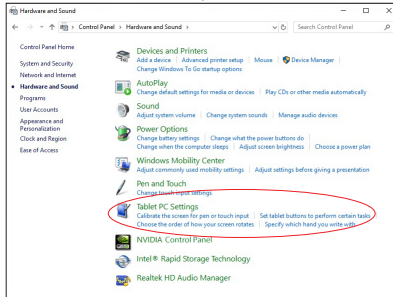
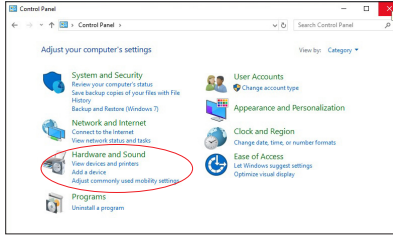

The following message will appear on the screen. Please follow the instructions.

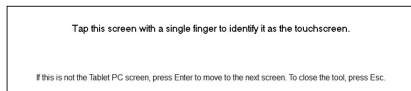

② After setting ①, connect a second monitor and perform the setup as in ①.

NOTE

The monitors are recognized as dual-display, and touch operation cannot be performed on two monitors at the same time.

You can perform touch operation on only one of the monitors.

OPERATING THE MONITOR

To create the best picture, your iiyama LCD monitor has been preset at the factory with the COMPLIANT TIMING shown on page 34. You are also able to adjust the picture by following the button operation shown below. For more detailed adjustments, see page 26 for SCREEN ADJUSTMENTS.

- 1 Press the **≡ (Enter) Button** to start the On Screen Display feature. There are additional Menu items which can be switched by using the **◀ / ▶ Buttons**.

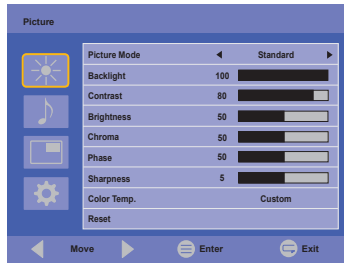

- 2 Select the Menu item of the adjustment you want to make. Press the **≡ Button** and enter the menu page. Then, use the **◀ / ▶ Buttons** to highlight the desired adjustment item.
- 3 Press the **≡ Button** again. Use the **◀ / ▶ Buttons** to make the appropriate adjustment or setting.
- 4 Press the **↶ (Exit) Button** to leave the menu, and the settings you just made would be automatically saved.

For example, to correct for vertical position, select "Screen" by using the **◀ / ▶ Buttons** and press the **≡ Button**. Next, select "Adjust Screen" by using the **◀ / ▶ Buttons** and press the **≡ Button**. Then, select "V. Position" by using the **◀ / ▶ Buttons** and press the **≡ Button**. Use the **◀ / ▶ Buttons** to change the vertical position settings. The vertical position of the overall display should be changing accordingly while you are doing this.

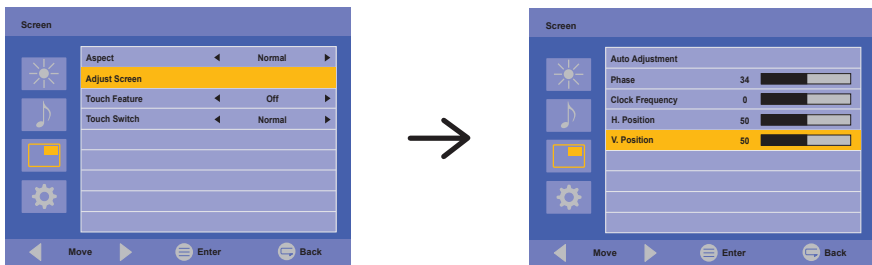

Press the **↶ Button** lastly and all changes are saved in the memory.

NOTE

- The **↶ Button** can be used to return previous menu item.
- Any changes are automatically saved in the memory when the On Screen Display disappears. Turning off the power should be avoided while using the Menu.
- Adjustments for Image Position, Clock Frequency and Phase are saved for each signal timing. Except for these adjustments, all other adjustments have only one setting which applies to all signal timings.

[LOCK MODE]

- **Rear Buttons:**

Pressing and holding the ≡ and ► Buttons for about 5 seconds, will lock/unlock the rear buttons function.

- **Power Button:**

Pressing and holding the ≡ and ↶ Buttons for about 5 seconds, will lock/unlock the Power Button function.











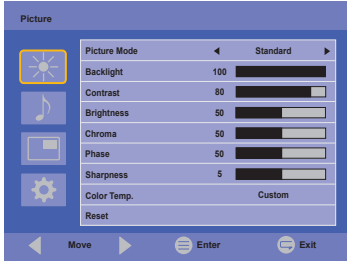

[PALM REJECTION FUNCTION]

Palm rejection is a way to disregard touch made with “a large contact area” while finger modes.

A large contact area: palm, clenched fist, elbow, arm, etc.

When you touch the screen with a finger, palm rejection is activated and the screen does not recognize touch made with the large contact area.

ADJUSTMENT MENU CONTENTS

Picture						
						
Adjustment Item	Problem / Option	Button to Press				
Picture Mode *3	Vivid	For displaying outdoor scenery images.				
	Standard	For general windows environment and monitor default setting.				
	Cinema	For movie and video environment.				
	Custom	Displays a picture on a screen set by Image Settings adjustments.				
Backlight	Brightness of back light is reduced.	 				
Contrast *3	Too dull					
	Too intense					
Brightness *1,3	Too dark					
	Too bright					
Chroma *2	Too weak					
	Too strong					
Phase	Purplish					
	Greenish					
Sharpness	Too soft					
	Too sharp					
Color Temp. *3	Cool	Cool color				
	Neutral	Neutral color				
	Warm	Warm color				
	Custom	<table border="1"> <tr> <td>R</td> <td rowspan="3">Too weak Too strong</td> </tr> <tr> <td>G</td> </tr> <tr> <td>B</td> </tr> </table>	R	Too weak Too strong	G	B
R	Too weak Too strong					
G						
B						
Reset	Cancel	Return to Menu.				
	OK	Resets all settings in the Picture menu.				

*1 Adjust the Brightness when you are using the monitor in a dark room and feel the screen is too bright.

*2 Only HDMI and DisplayPort inputs.

*3 Contrast, Brightness, Color Temp. and Picture Mode cannot be adjusted and selected while Adv. Contrast is active.



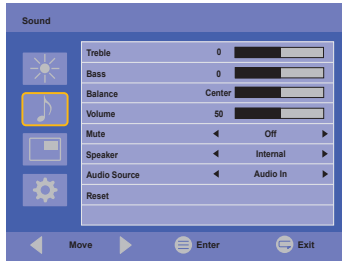





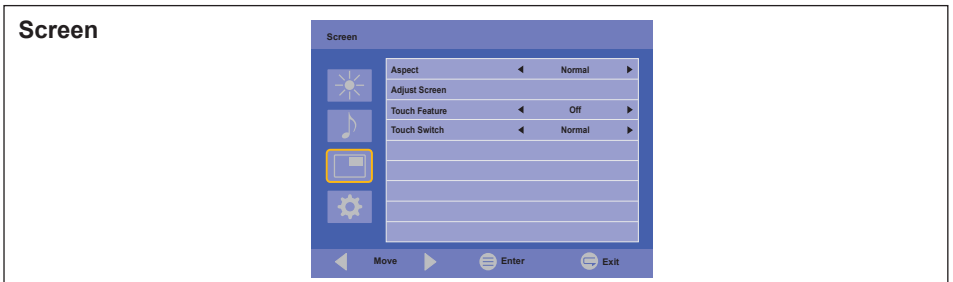





Sound



Adjustment Item	Problem / Option		Button to Press
Treble	Too weak		➡
	Too strong		⬅
Bass	Too weak		➡
	Too strong		⬅
Balance	Left side speaker louder		➡
	Right side speaker louder		⬅
Volume	Too soft		➡
	Too loud		⬅
Mute	Off	Return the sound volume to the previous level.	
	On	Turn off the sound temporarily.	
Speaker	Internal	Select the Internal Speaker.	
	Line-out *	Select the External Speaker or Headphone.	
Audio Source	Auto	Select the audio input automatically.	
	Audio In	Select the Line-In input.	
	DP	Select the DisplayPort input.	
Reset	Cancel	Return to Menu.	
	OK	Resets all settings in the Sound Settings menu.	

* Available for HDMI and DisplayPort input only.



Adjustment Item	Problem / Option		Button to Press
Aspect *5	Normal *2	Enlarges the picture to fill the screen in the vertical direction, keeping the same aspect ratio.	
	16:10 *1	Displays all picture in 16:10 aspect ratio.	
	5:4 *1	Displays all picture in 5:4 aspect ratio.	
	4:3 *1	Displays all picture in 4:3 aspect ratio.	
	Real *2	Displays the picture dot by dot.	
Adjust Screen *3	Auto Adjustment *4	Cancel	Return to Menu.
		OK	Adjusts Position, Clock Frequency and Phase automatically.
	Phase	To correct flickering text or lines	 
	Clock Frequency	 Too narrow	
		 Too wide	
H. Position	 Too far to the left		
	 Too far to the right		
V. Position	 Too low		
	 Too high		
Touch Feature	Off	Return to Menu.	
	On	Enable the touch function. NOTE Display wall will be disabled to optimize touch performance.	
Touch Switch *6	Normal	Normal touch (with bare hands or stylus device)	
	Glove	Touch with gloved hand (Supports thickness +2mm)	
	Through-Glass	Touch through glass (Supports thickness +6mm)	

*1 Only HDMI(Video) and DisplayPort inputs.

*2 Only VGA and HDMI(PC) inputs.

*3 Only VGA input.

*4 For best results, use the Auto Adjust in conjunction with the adjustment pattern. See page 26 for SCREEN ADJUSTMENTS.

*5 If the Touch Feature is enabled, this feature is not available.

*6 Turn on the power and set the Touch Switch after the monitor installation is completed. Turning on the power and setting the Touch Switch before the monitor installation may cause misalignment or malfunction of the touch calibration.

Setting

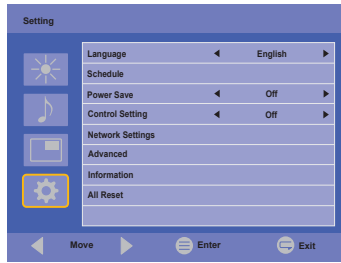

Adjustment Item	Problem / Option		Button to Press	
Language	English	English	Nederlands	Dutch
	Français	French	Polski	Polish
	Español	Spanish	Русский	Russian
	Deutsch	German	Italiano	Italian
Schedule	Today * ¹	Displays the current date and time. Year/Month/Day/Hour/Minute/Time set/Date set		
	Clock Display	Off	Clock Display is turned off.	
		On	Displays time.	
On/Off Timer	Sets when to turn on or off the monitor. Off/On(Date Set/Input/On Timer/Off Timer)			
Power Save * ²	Off	Power Save is turned off.		
	Low	All input sources can activate entering the power saving mode, but only the VGA signal can deactivate it. If an another input source is connected you have to press the POWER button.		
Control Setting	Off	Control Setting is turned off.		
	RS-232C	Selects the RS-232C to control the monitor.		
	LAN	Selects this option to control the monitor via LAN.		
Network Settings * ⁶	DHCP	Cancel	Return to Menu.	
		Execute	Once you are connected, the IP Address, Subnet mask, Default gateway, Primary DNS and Secondary DNS settings are displayed automatically.	
	Manual	If you are not connected, contact your IT administrator for information on the IP Address, Subnet mask, Default gateway, Primary DNS and Secondary DNS settings and enter them accordingly.		
	Reset	Cancel / OK		
Advanced	Auto Search	Off	Auto Search is turned off.	
		On	Automatically detects available input sources.	
	Auto Adjustment * ³	Off	Auto Adjustment is turned off.	
		On	Adjusts Position, Clock Frequency and Phase automatically.	

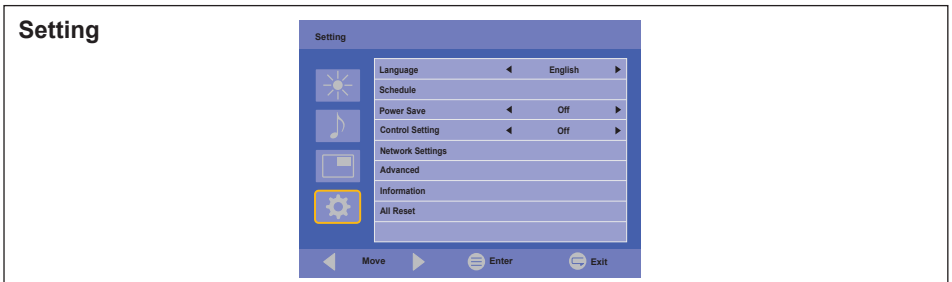

Adjustment Item	Problem / Option		Button to Press	
Advanced	OSD Rotation	Landscape	Landscape display	
		Portrait	Portrait display	
	OSD Info Box	Off	OSD Info Box is turned off.	
		On	Switching signal inputs, or changing timing, the current input source and resolution information will be displayed on the screen.	
	Adv. Contrast	Off	Typical Contrast Ratio	
		On	Increased Contrast Ratio	
	DP	Not available on this model.		
	Opening Logo	Off	iiyama Logo does not display when the monitor is turned on.	
		On	iiyama Logo displayed when the monitor is turned on.	
	Anti Image Retention	Dot Wash	Off	Dot wash is turned off.
			On	Draw a 4x4 pixel block on the screen.
	Fan ^{*4}	White Wash	To prevent burn-in, set the display time of all white pattern after Sleep mode with no signal. Off / 15min / 30min	
Auto		The fan turns on automatically when the monitor's internal temperature reaches 60°C or higher.		
Off		Fan is turned off.		
All Reset	Cancel	Return to Menu.		
	OK	Factory-preset data is restored.		
Information	Model Name/Operation Time/Software Version/LAN Version/IP Address ^{*5} NOTE See your graphic card user guide for more information about changing the resolution and refresh.			

*1 You must set this item when using "On/Off Timer".

*2 RS-232C can bring any mode out of the power saving status.

*3 For best results, use the Auto Adjust in conjunction with the adjustment pattern. See page 26 for SCREEN ADJUSTMENTS.

*4 If the screen is used in face-up position, please be sure to turn on the FAN function.

*5 IP address is displayed only when LAN is connected.

*6 It can be used when LAN of Control Setting is selected.

SCREEN ADJUSTMENTS

Adjust the image by following the procedure below to get the desired picture when selecting Analog input.

- The screen adjustments described in this manual are designed to set image position and minimize flicker or blur for the particular computer in use.
- The monitor is designed to provide the best performance at resolution of 1920 × 1200, but can not provide the best at resolutions of less than 1920 × 1200 because the picture is automatically stretched to fit the full screen. It is recommended to operate at resolution of 1920 × 1200 in normal use.
- Displayed text or lines will be blurred or irregular in thickness when the picture is stretched due to the screen enlargement process.
- It is preferable to adjust the image position and frequency with the monitor controls, rather than the computer software or utilities.
- Perform adjustments after a warm-up period of at least thirty minutes.
- Additional adjustments may be required after the Auto Adjustment depending on the resolution or signal timing.
- The Auto Adjustment may not work correctly when displaying the picture other than the screen adjustment pattern. In this case, manual adjustments are required.

There are two ways to adjust the screen. One way is automatic adjustment for Position, Clock Frequency and Phase. The other way is performing each adjustment manually.

Perform the Auto Adjustment first when the monitor is connected to a new computer, or resolution is changed. If the screen has a flicker or blur, or the picture does not fit in the display area after performing the Auto Adjustment, manual adjustments are required. Both adjustments should be made by using the screen adjustment pattern (Test.bmp) obtained via the IYAMA web site (<http://www.iiyama.com>).

Adjust the image by following the procedure below to get the desired picture.

This manual explains adjustment under Windows® OS.

- ① **Display the picture at the optimum resolution.**
- ② **Enter the Test.bmp (screen adjustment pattern) to wallpaper.**

NOTE

- Consult the appropriate documentation for doing this.
- Set the display position to center in the wallpaper setting dialogue box.

[Adjustment pattern]

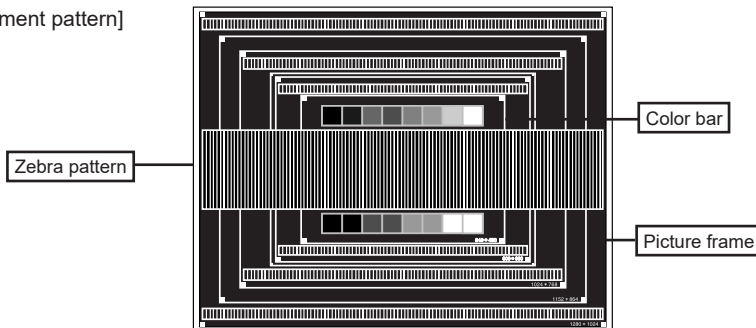

③ Perform the Auto Adjustment.

④ Adjust the image manually by following procedure below when the screen has a flicker or blur, or the picture does not fit in the display area after performing the Auto Adjustment.

⑤ Adjust the V. Position so that the top and bottom of the picture frame will fit to the display area.

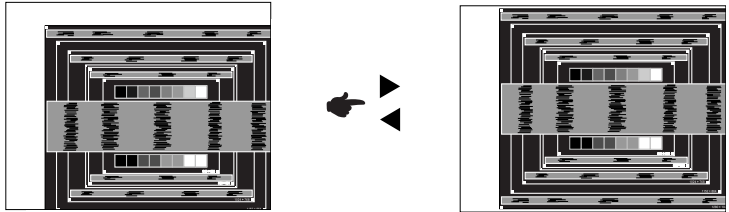

⑥ 1) Adjust the H. Position so that the left side of the picture frame will move to the left edge of the display area.

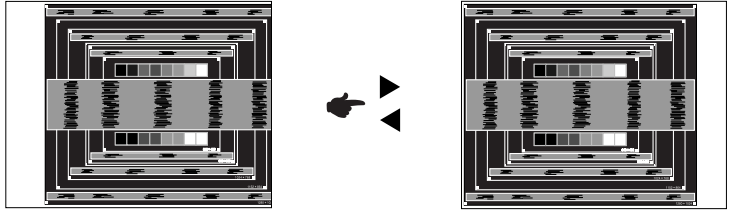

2) Stretch the right side of the picture frame to the right edge of the display area by adjusting the Clock Frequency.

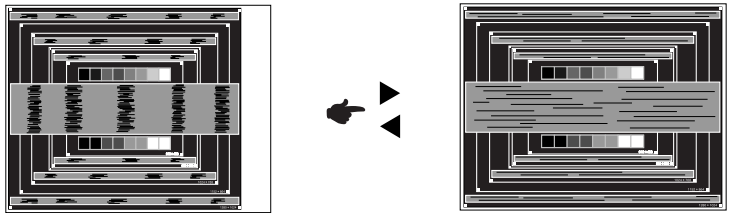

- NOTE**
- When the left side of the picture frame moves apart from the left edge of the display area during the Clock Frequency adjustment, adjust steps 1) and 2).
 - Another way to make the Clock Frequency adjustment is to correct the vertical wavy lines in the zebra pattern.
 - The picture may flicker during the Clock Frequency, H./V. Position adjustment.
 - In case the picture frame is bigger or smaller than the data display area after the Clock Frequency adjustment, repeat steps from ③.

- ⑦ **Adjust the Phase to correct horizontal wavy noise, flicker or blur in the zebra pattern.**

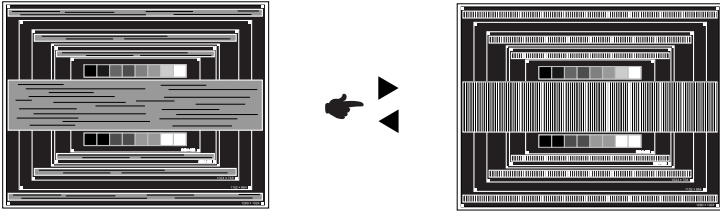

NOTE

- In case the strong flicker or blurs remain on a part of the screen, repeat steps ⑥ and ⑦ because the Clock Frequency may not be adjusted correctly.
- Adjust the H. Position after the Phase adjustment if the horizontal position moves during the adjustment.

- ⑧ **Adjust the Brightness and Color to get the desired picture after you complete the Clock Frequency and Phase adjustments.**

Put back your favorite wallpaper.

STANDBY FEATURE

The standby feature of this product complies with power saving requirement of VESA DPMS. When activated, it automatically reduces unnecessary power consumption of the monitor when your computer is not in use.

To use the feature, the monitor needs to be connected to a VESA DPMS compliant computer. There is a standby step the monitor takes as described below. The standby function, including any timer settings is configured by the operating system. Check your operating system manual for information on how this can be configured.

■ Standby Mode

When the video signal from the computer is off, the monitor enters into Standby Mode which reduces the power consumption to less than 1.5W*. The screen becomes dark, and the power indicator turns to orange. From Standby Mode, the image reappears in several seconds when either the keyboard or the mouse are touched again.

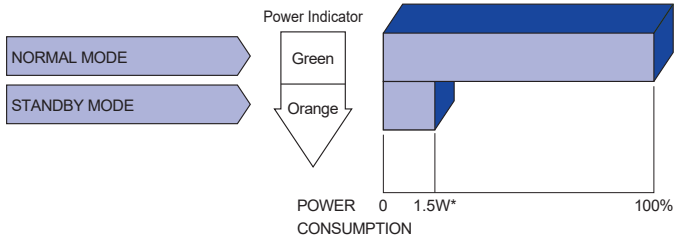

* USB peripheral and audio equipment are not connected.

NOTE Even when using the standby mode, the monitor consumes electricity. Turn off the Power Switch whenever the monitor is not in use, during the night and weekends, to avoid unnecessary power consumption.

TROUBLE SHOOTING

If the monitor fails to operate correctly, please follow the steps below for a possible solution.

1. Perform the adjustments described in OPERATING THE MONITOR, depending on the problem you have. If the monitor does not get a picture, skip to 2.
2. Consult the following items if you cannot find an appropriate adjustment item in OPERATING THE MONITOR or if the problem persists.
3. If you are experiencing a problem which is not described below or you cannot correct the problem, discontinue using the monitor and contact your dealer or iiyama service center for further assistance.

Problem

Check

- | | |
|---|---|
| ① The picture does not appear.
(Power indicator does not light up.)

(Power indicator is green.)

(Power indicator is orange.) | <input type="checkbox"/> The Power Cable is firmly seated in the socket.
<input type="checkbox"/> The Power Switch is turned ON.
<input type="checkbox"/> The AC socket is live. Please check with another piece of equipment.

<input type="checkbox"/> If the blank screen saver is in active mode, touch the keyboard or the mouse.
<input type="checkbox"/> Increase the Contrast and/or Brightness.
<input type="checkbox"/> The computer is ON.
<input type="checkbox"/> The Signal Cable is properly connected.
<input type="checkbox"/> The signal timing of the computer is within the specification of the monitor.

<input type="checkbox"/> If the monitor is in standby mode, touch the keyboard or the mouse.
<input type="checkbox"/> The computer is ON.
<input type="checkbox"/> The Signal Cable is properly connected.
<input type="checkbox"/> The signal timing of the computer is within the specification of the monitor. |
| ② The screen is not synchronized. | <input type="checkbox"/> The Signal Cable is properly connected.
<input type="checkbox"/> The signal timing of the computer is within the specification of the monitor. |
| ③ The screen position is not in the center. | <input type="checkbox"/> The signal timing of the computer is within the specification of the monitor. |
| ④ The screen is too bright or too dark. | <input type="checkbox"/> The video output level of the computer is within the specification of the monitor. |
| ⑤ The screen is shaking. | <input type="checkbox"/> The power voltage is within the specification of the monitor.
<input type="checkbox"/> The signal timing of the computer is within the specification of the monitor. |
| ⑥ No sound. | <input type="checkbox"/> The audio equipment (computer etc.) is ON.
<input type="checkbox"/> The Audio Cable is properly connected.
<input type="checkbox"/> The Volume is turned up.
<input type="checkbox"/> The Mute is OFF.
<input type="checkbox"/> The audio output level of the audio equipment is within the specification of the monitor. |
| ⑦ The sound is too loud or too quiet. | <input type="checkbox"/> The audio output level of the audio equipment is within the specification of the monitor. |

Problem	Check
⑧ A strange noise is heard.	<input type="checkbox"/> The Audio Cable is properly connected.
⑨ The touch screen shows no response.	<input type="checkbox"/> The USB Cable is firmly seated in the socket. <input type="checkbox"/> Touch screen driver software is installed.
⑩ The touch position does not deviate.	<input type="checkbox"/> The calibration function set up correctly.

RECYCLING INFORMATION

For better environment protection please don't dispose your monitor.
Please visit our web site: www.iiyama.com for monitor recycling.

APPENDIX

Design and specifications are subject to change without prior notice.

SPECIFICATIONS : ProLite TF6539UHSC-B1AG

Touch Screen	Technology	Projected capacitive 50 points
	Light transmission	84%
	Hardness	7H
	Thickness	5mm
	Communication system	USB serial transfer
Size Category		65"
LCD Panel	Panel technology	IPS
	Size	Diagonal: 65" (164cm)
	Pixel pitch	0.372mm H × 0.372mm V
	Brightness	500cd/m ² (Typical) 420cd/m ² (with Touch panel)
	Contrast ratio	1100 : 1 (Typical)
	Viewable angle	Horizontal : 178 degrees, Vertical: 178 degrees (Typical)
	Response time	8ms (Gray to Gray)
	Pixel format	3840(H), 2160(V) Pixels
Display Colors		Analog: Approx. 16.7M Digital: Approx. 1.07B
Sync Frequency		VGA: Horizontal: 30.0-83.0kHz, Vertical: 50-76Hz HDMI1/DisplayPort: Horizontal: 30.0-135.0kHz, Vertical: 23-76Hz HDMI2: Horizontal: 30.0-83.0kHz, Vertical: 23-76Hz
Supported max. resolution		VGA: 1920 × 1200, 60Hz HDMI1/DisplayPort: 3840 × 2160, 60Hz HDMI2: 3840 × 2160, 30Hz
Input Connector		VGA, HDMI×2, DisplayPort
Input Audio Connector		mini jack
LAN		RJ45
Serial Port		RS-232C In
Input Sync Signal		Separate sync: TTL, Positive or Negative
Input Video Signal		Analog: 0.7Vp-p (Standard), 75Ω, Positive Digital: HDMI1, HDMI2, DisplayPort
Input Audio Signal		2Vrms maximum
Headphone Connector		mini jack
Speakers		8W×2 (Stereo speakers)
Maximum Screen Size		1430.9mm W × 806.0mm H / 56.3" W × 31.7" H
Power Source		100-240VAC, 50-60Hz, 2.2A
Power Consumption*		175W typical Standby mode: 1.5W maximum, Off mode: 0.3W maximum

NOTE * USB peripheral and audio equipment are not connected.

Dimensions / Net Weight	1503.5 × 880.5 × 67.0mm / 59.2 × 34.7 × 2.6" (W×H×D) 56.0kg / 123.5lbs	
Environmental Considerations	Operating: Temperature	0 to 40°C / 32 to 104°F
	Humidity	10 to 90% (No condensation)
	Storage: Temperature	-20 to 60°C / 4 to 140°F
	Humidity	10 to 90% (No condensation)
Approvals	CE, UKCA, EAC, cULus	

DIMENSIONS : ProLite TF6539UHSC-B1AG

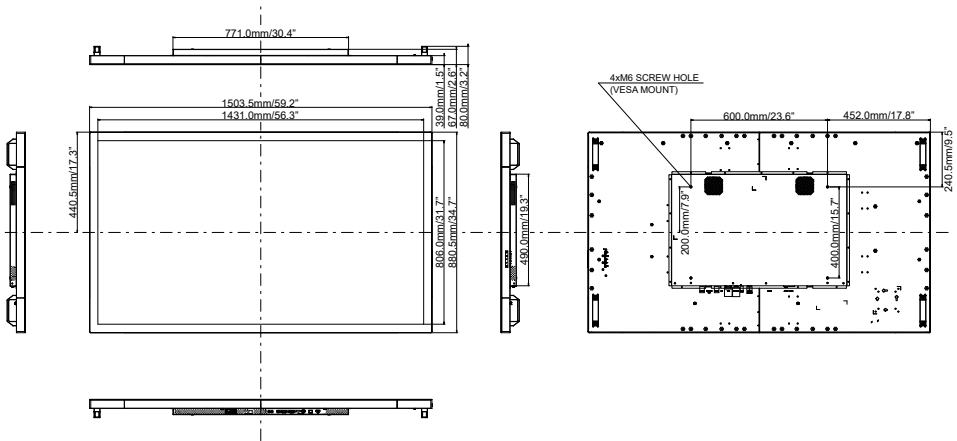

COMPLIANT TIMING

Video Mode		Horizontal Frequency	Vertical Frequency	Dot Clock		
VESA	VGA	640 × 480	31.469kHz	59.940Hz	25.175MHz	
		720 × 400	31.467kHz	70.080Hz	28.320MHz	
	SVGA	800 × 600	37.879kHz	60.317Hz	40.000MHz	
	XGA	1024 × 768	48.363kHz	60.004Hz	65.000MHz	
		1280 × 720	44.720kHz	60.000Hz	74.500MHz	
	SXGA	1280 × 1024	63.981kHz	60.020Hz	108.000MHz	
			79.976kHz	75.025Hz	135.000MHz	
	WSXGA+	1680 × 1050	65.290kHz	59.954Hz	146.250MHz	
	Full HD	1920 × 1080	67.500kHz	60.000Hz	148.500MHz	
	WUXGA	1920 × 1200	74.038kHz	59.950Hz	154.000MHz	
UHD	3840 × 2160	67.430kHz	29.970Hz	296.700MHz	*1	
		133.313kHz	59.997Hz	533.250MHz	*2	
SD	480p	60Hz	31.469kHz	59.940Hz	27.000MHz	*1
	576p	50Hz	31.250kHz	50.000Hz	27.000MHz	*1
HD	720p	50Hz	37.500kHz	50.000Hz	74.250MHz	*1
	720p	60Hz	45.000kHz	60.000Hz	74.250MHz	*1
	1080p	24Hz	27.000kHz	24.000Hz	74.250MHz	*1
	1080p	30Hz	33.750kHz	30.000Hz	74.250MHz	*1
	1080p	50Hz	56.250kHz	50.000Hz	148.500MHz	*1
	1080p	60Hz	67.500kHz	60.000Hz	148.500MHz	*1

*1 HDMI1 / HDMI2 / DisplayPort input only.

*2 HDMI1 / DisplayPort input only.