



RM6503/RM7503/RM8603
Interactive Flat Panel
User Manual



Disclaimer

BenQ Corporation makes no representations or warranties, either expressed or implied, with respect to the contents of this document. BenQ Corporation reserves the right to revise this publication and to make changes from time to time in the contents thereof without obligation to notify any person of such revision or changes.

HDMI trademark disclaimer

The terms HDMI and HDMI High-Definition Multimedia Interface, and the HDMI Logo are trademarks or registered trademarks of HDMI Licensing Administrator, Inc. in the United States and other countries.



Copyright

Copyright 2021 BenQ Corporation. All rights reserved. No part of this publication may be reproduced, transmitted, transcribed, stored in a retrieval system or translated into any language or computer language, in any form or by any means, electronic, mechanical, magnetic, optical, chemical, manual or otherwise, without the prior written permission of BenQ Corporation.

Product support

This document aims to provide the most updated and accurate information to customers, and thus all contents may be modified from time to time without prior notice. Please visit the website for the latest version of this document and other product information. Available files vary by model.

1. Make sure your computer is connected to the Internet.
2. Visit the local website from www.BenQ.com. The website layout and content may vary by region/country.
 - User manual and related document: www.BenQ.com > **Business** > **SUPPORT** > **Downloads** > model name > **User Manual**
 - (EU only) Dismantled information: Available on the user manual download page. This document is provided based on Regulation (EU) 2019/2021 to repair or recycle your product. Always contact the local customer service for servicing within the warranty period. If you wish to repair an out-of-warranty product, you are recommended to go to a qualified service personnel and obtain repair parts from BenQ to ensure compatibility. Do not disassemble the product unless you are aware of the consequences. If you cannot find the dismantled information on your product, contact the local customer service for assistance.

Table of Contents

Product support.....	3
Safety warnings and precautions	6
Important safety instructions.....	7
Notes on this display	7
Notes on the LCD panel of this display	7
Safety notice for remote control	8
Battery safety notice	8
BenQ ecoFACTS	9
Package contents	10
Setting up the display	11
Mounting the display	11
Installing an external PC.....	12
Parts of the display and their functions	14
Front panel	14
Input/output terminals.....	16
Remote control.....	18
Using the remote control.....	19
Connection	22
Connecting the VGA input.....	22
Connecting the touch module.....	23
Connecting the digital inputs	24
Connecting the video output.....	25
Connecting to serial port	26
Connecting power	27
Basic operations.....	28
Turning the display on or off	28
Initial setup	29
OSD Setting	29
Switching input signals	29
Setting up the Internet connection.....	33
Updating software	35
Adjusting audio volume level	35

Using the touch screen.....	36
Important instructions for using the touch screen.....	38
Menu operations.....	39
One touch menu operation	39
Settings menu.....	39
System settings	48
Android system interface.....	52
Main interface	52
Side tool bar.....	53
EZ Floating Tool	54
AMS file manager overview	55
InstaShare 2.....	63
Product information.....	64
Specifications.....	64
Dimensions (RM6503).....	68
Dimensions (RM7503).....	69
Dimensions (RM8603).....	70
Supported input signal resolution	71
Troubleshooting	72
Accessibility Requirements for Rehabilitation Act of 1973, Section 508	75

Safety warnings and precautions



The lightning flash with arrowhead symbol, within an equilateral triangle, is intended to alert the user to the presence of uninsulated “dangerous voltage” within the product’s enclosure that may be of sufficient magnitude to constitute a risk of electric shock to persons.



The exclamation point within an equilateral triangle is intended to alert the user to the presence of important operating and maintenance (servicing) instructions in the literature accompanying the appliance.



THIS EQUIPMENT MUST BE GROUNDED

To ensure safe operation, the three-pin plug must be inserted only into a standard three-pin power outlet which is effectively grounded through normal household wiring. Extension cords used with the equipment must have three cores and be correctly wired to provide connection to the ground. Wrongly wired extension cords are a major cause of fatalities.

The fact that the equipment operates satisfactorily does not imply that the power outlet is grounded or that the installation is completely safe. For your safety, if you are in any doubt about the effective grounding of the power outlet, please consult a qualified electrician.

- The mains plug of the power supply cord shall remain readily operable. The AC receptacle (mains socket outlet) shall be installed near the equipment and shall be easily accessible. To completely disconnect this equipment from the AC mains, disconnect the power cord plug from the AC receptacle.
- Do not place this display on an uneven, sloping or unstable surface (such as a trolley) where it may fall and cause damage to itself or others.
- Do not place this display near water, like a spa or pool, or in a position which will allow the splashing or spraying of water onto the display, like in front of an open window where rain water may enter.
- Do not install this display in a confined space without proper ventilation and air circulation, such as in a closed cabinet. Allow proper space around the display for dissipating heat inside. Do not block any openings and vents on the display. Overheating may result in hazards and electric shock.
- Installation of this display should only be performed by a qualified technician. Failure to install this display properly may cause injuries and damages to the personnels and the display itself. Check the installation regularly and maintain the display periodically to ensure the best working condition.
- Use only the accessories approved or recommended by the manufacturer to mount this display. Using wrong or unsuitable accessories may cause the display to fall and result in serious personal injuries. Make sure that the surface and fixing points are strong enough to sustain the weight of the display.
- To reduce the risk of electric shock, do not remove covers. No user serviceable parts inside. Refer servicing to qualified service personnel.
- To prevent personal injuries, mounting the display is required before use.

Important safety instructions

1. Read these instructions.
2. Keep these instructions.
3. Heed all warnings.
4. Follow all instructions.
5. Do not use this apparatus near water.
6. Clean only with dry cloth.
7. Do not block any ventilation openings. Install in accordance with the manufacturer's instructions.
8. Do not install near any heat sources such as radiators, heat registers, stoves, or other apparatus (including amplifiers) that produce heat.
9. Do not defeat the safety purpose of the polarized or grounding-type plug. A polarized plug has two blades with one wider than the other. A grounding-type plug has two blades and a third grounding prong. The wide blade or the third prong are provided for your safety. If the provided plug does not fit into your outlet, consult an electrician for replacement of the obsolete outlet.
10. Protect the power cord from being walked on or pinched particularly at plugs, convenience receptacles, and the point where they exit from the apparatus.
11. Only use attachments/accessories specified by the manufacturer.
12. Use only with the cart, stand, tripod, bracket, or table specified by the manufacturer, or sold with the apparatus. When a cart is used, use caution when moving the cart/apparatus combination to avoid injury from tip-over.
13. Unplug this apparatus during lightning storms or when unused for long periods of time.
14. Refer all servicing to qualified service personnel. Servicing is required when the apparatus has been damaged in any way, such as power-supply cord or plug is damaged, liquid has been spilled or objects have fallen into the apparatus, the apparatus has been exposed to rain or moisture, does not operate normally, or has been dropped.



Notes on this display

- To prevent the risk of physical injuries, do not attempt to lift the display alone.
- Make sure you have four or more people available to help lift or a flat cart to transport the display to its final location.
- Keep the display horizontal as much as possible.
- Clear a floor space before unpacking.

Notes on the LCD panel of this display

- The Liquid Crystal Display (LCD) panel of this display has a very thin protective layer of glass which is liable to marking or scratching, and cracking if struck or pressured. The liquid crystal substrate is also liable to damage under excessive force or extreme temperatures. Please handle with care.
- The response time and brightness of the LCD panel may vary with the ambient temperature.

- Avoid placing the display in direct sun or where direct sun or spot lighting will shine onto the LCD panel, as the heat may damage the panel and the external casing of the display, and the bright light will make viewing the display more difficult than necessary.
- The LCD panel consists of individual pixels to display images and is manufactured according to the design specifications. While 99.9% of these pixels work normally, 0.01% of the pixels may remain constantly lit (in red, blue or green) or unlit. This is a technical limitation of the LCD technology and is not a defect.
- LCD screens, like plasma (PDP) and conventional CRT (Cathode Ray Tube) screens, are also susceptible to 'screen burn-in' or 'image retention' which can be found on the screen as visible fixed lines and shades. To avoid such damage to the screen, avoid displaying still images (like On-Screen Display menus, TV station logos, fixed/inactive text or icons) for more than 30 minutes. Change the aspect ratio from time to time. Fill the entire screen with the image and eliminate the black bars whenever possible. Avoid displaying images in 16:9 aspect ratio over a long period of time, otherwise there may be visible burn marks on the screen as two vertical lines.
Note: Under certain circumstances, condensation may occur on the inner side of the cover glass, it's a natural phenomenon and will not affect the operation of the display. This condensation will usually disappear after around 2 hours of normal operation.
- RP series does not offer image retention function, for more information, please refer to installation guide. If a still image is required for a display, it is recommended to enable **Pixel shift**. See [Advanced settings on page 46](#) for more information.
- RP series does not support portrait use; portrait use may cause display damage. BenQ warranty will not cover faulty usage.

Safety notice for remote control

- Do not put the remote control in the direct heat, humidity, and avoid fire.
- Do not drop the remote control.
- Do not expose the remote control to water or moisture. Failure to do so could result in malfunction.
- Confirm there is no object between the remote control and the remote sensor of the product.
- When the remote control will not be used for an extended period, remove the batteries.

Battery safety notice

The use of the wrong type of batteries may cause chemical leaks or explosion. Please note the following:

- Always ensure that the batteries are inserted with the positive and negative terminals in the correct direction as shown in the battery compartment.
- Different types of batteries have different characteristics. Do not mix different types.
- Do not mix old and new batteries. Mixing old and new batteries will shorten battery life or cause chemical leaks from the old batteries.
- When batteries fail to function, replace them immediately.
- Chemicals which leak from batteries may cause skin irritation. If any chemical matter seeps out of the batteries, wipe it up immediately using a dry cloth, and replace the batteries as soon as possible.

- Due to varying storage conditions, the battery life for the batteries included with your product may be shortened. Replace them within 3 months or as soon as you can after initial use.
- There may be local restrictions on the disposal or recycling of batteries. Consult your local regulations or waste disposal provider.

BenQ ecoFACTS

BenQ has been dedicated to the design and development of greener product as part of its aspiration to realize the ideal of the “Bringing Enjoyment 'N Quality to Life” corporate vision with the ultimate goal to achieve a low-carbon society. Besides meeting international regulatory requirement and standards pertaining to environmental management, BenQ has spared no efforts in pushing our initiatives further to incorporate life cycle design in the aspects of material selection, manufacturing, packaging, transportation, using and disposal of the products. BenQ ecoFACTS label lists key eco-friendly design highlights of each product, hoping to ensure that consumers make informed green choices at purchase. Check out BenQ's CSR Website at <http://csr.BenQ.com/> for more details on BenQ's environmental commitments and achievements.



Package contents

Open the sales package and check the contents. If any item is missing or damaged, please contact your dealer immediately.



LCD display

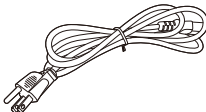

Power cord (By Region)

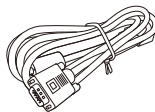

VGA cable x 1

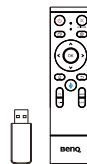

2.4GHz remote control and dongle

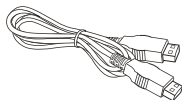

HDMI cable x 1

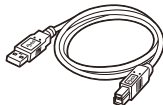

Touch USB cable x 1

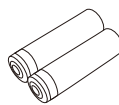

AAA battery x 2 (By Region)

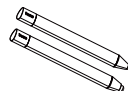

Touch pen x 2



Quick start guide

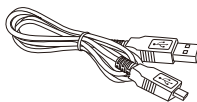

USB Type-C cable x 1



Wall mount x 1

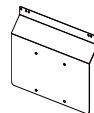

Steel pad x 1



- The type of power cord supplied may differ from that illustrated depending on your region of purchase.
- Before discarding the package, check that you haven't left any accessories inside the box.
- Dispose of packaging materials wisely. You can recycle the cardboard carton. Consider storing the package (if possible) for future transport of the display.
- Do not leave plastic bags within reach of young children or babies.

Setting up the display

Mounting the display

You can install the display on a vertical surface with a suitable wall mounting bracket. Please pay attention to the following notes during installation:

- This display should be installed by at least two adult persons. Attempting to install this display by only one person may result in danger and injuries.
- Refer the installation to qualified technicians. Improper installation may cause the display to fall or malfunction.

Installing the display on a wall

1. Place a clean, dry and lint-free cloth on a flat, horizontal and object-free surface. Make sure that the size of the cloth is larger than the display.
2. Gently lay the display on the cloth with the LCD screen facing down.
3. **Stability Hazard:** The flat panel may fall, causing serious personal injury or death. To prevent injury, this flat panel must be securely attached to the wall in accordance with the installation instructions.

RM6503

*Screw type: M8*20L

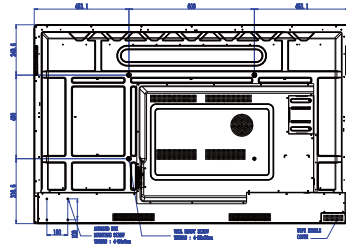

4. Identify the wall mounting screw holes on the back of the display as shown in the illustration.

RM7503

*Screw type: M8*20L

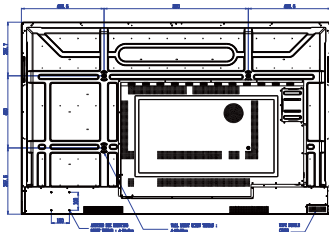

RM8603

*Screw type: M8*20L

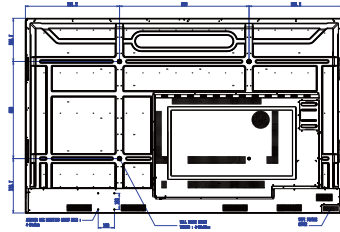

5. Install the wall mounting bracket on the display and attach the display to the wall according to the mounting bracket's instructions. The length of the screw should exceed the thickness of the wall mounting bracket by at least 25 mm. Make sure that all screws are tightened and secured properly. (Recommended torque: 470 - 635N•cm). The mounting means should be strong enough to bear the weight of the display.

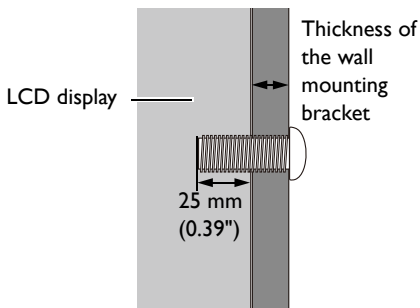

- To maintain proper ventilation, keep at least 10 mm of clear space from the back cover of the display to the wall.
- Please consult a professional technician for wall mount installations. The manufacturer accepts no liability for installations not performed by a professional technician.

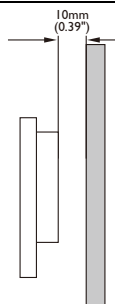

Installing an external PC

You can mount an external PC to the display using either one of the following methods:

- The back of the display has four screw holes at its bottom-left side with a dimension of VESA mount 100x100mm. You can secure the PC onto the display with four screws (maximum torque: 4-5 kgf-cm).

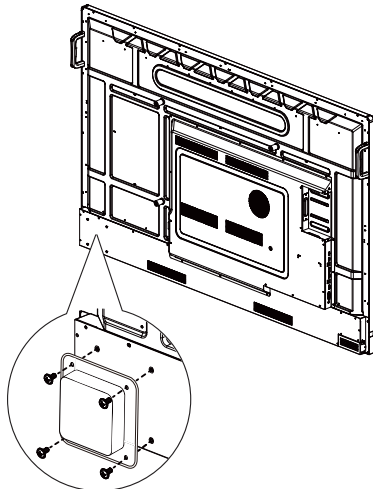

- The package includes a steel pad that supports VESA mounting (dimension 100x100mm). You can install the steel pad to the external PC with four screws and then secure the PC with steel pad assembly onto the top-right side of the display with two M3x6 screws (maximum torque: 4-5 kgf-cm).

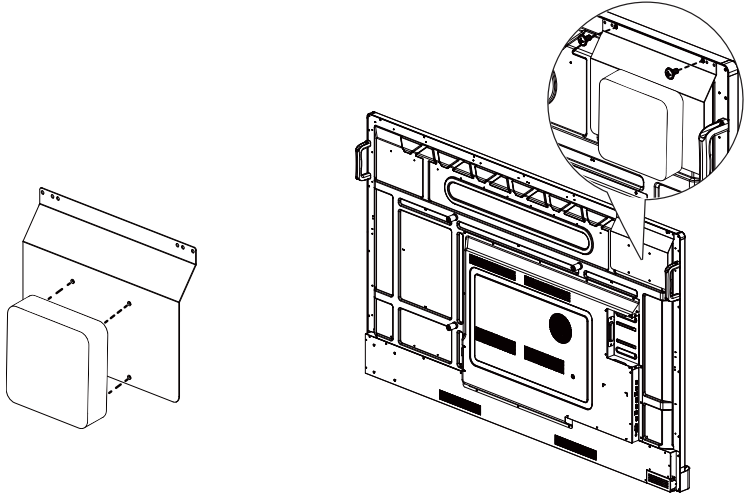

Parts of the display and their functions

Front panel

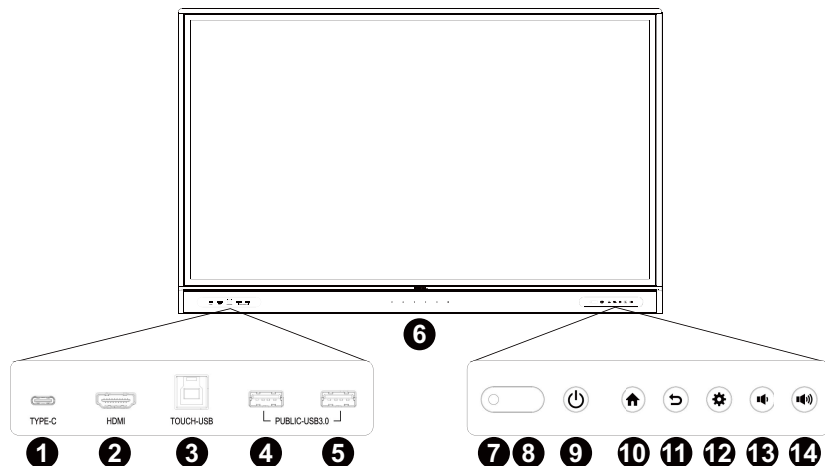

No.	Name	Description
1	TYPE-C	USB Type-C. Connect with display, audio, touch, and/or charge devices. Does not support data transfer.
2	HDMI	High-definition multimedia interface signal input. Connect to a PC with an HDMI output, a set-top-box, or other video devices. Capable of supporting touch function.
3	TOUCH-USB	Supports touch signal input from an external computer. When connecting the external computer, besides connecting the external computer's video and audio signals via their respective ports, the external computer's USB port needs to be connected to the corresponding touch port. Once the driver is installed, the external computer can be controlled via touch gestures on the display (the touch function is enabled for the HDMI channels by default).
4	USB 3.0	Connect USB devices such as keyboards, mice, and USB flash drives.
5	USB 3.0	
6	Array Microphones	Receives and transmits sound from near the display.
7	Ambient Light Sensor	Detects the ambient light around the display.
8	IR Signal Receiver	Receive IR signals. Do not obstruct the receiver.
9	Power	Tap to enter sleep mode. Press and hold for 4 seconds or more to power off.
10	Home	Press to return to the main screen.

No.	Name	Description
11	Return	Press to return to the previous menu.
12	Menu	Press to enter the function menu.
13	Volume Down	Press to decrease the volume.
14	Volume Up	Press to increase the volume.

Input/output terminals

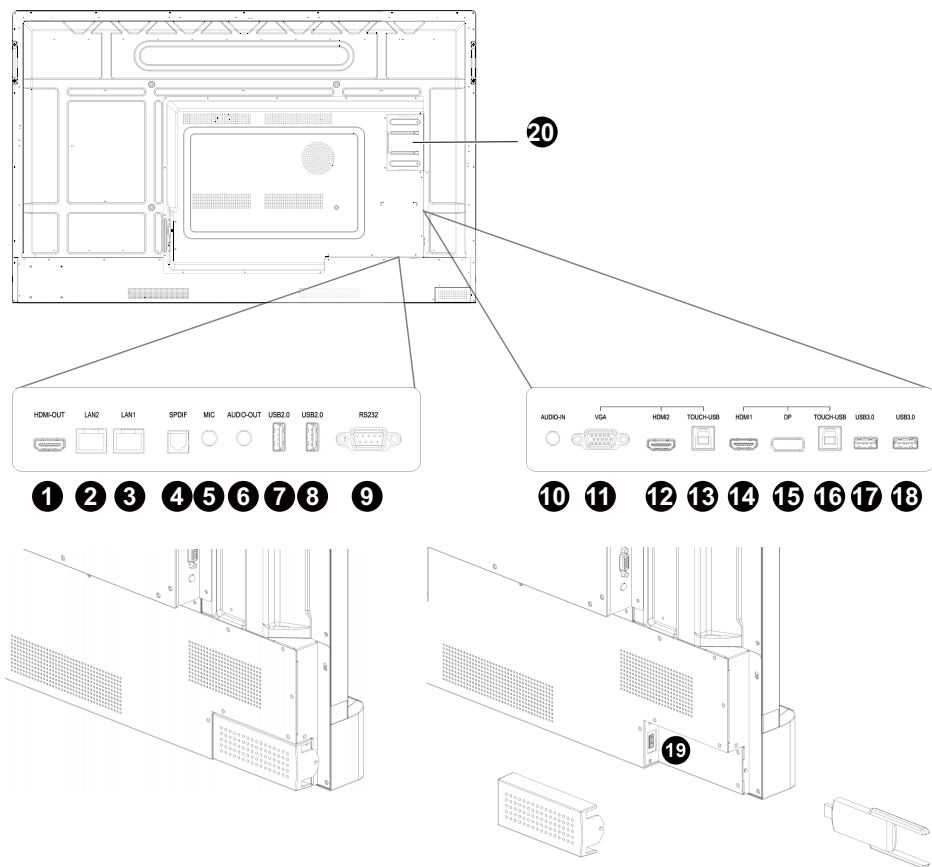

No.	Name	Description
1	HDMI OUT	Connect to display devices with an HDMI input.
2	LAN2	Supports LAN In and Out, 10/100 Mbps for Android system, 10/100/1000 Mbps for OPS.
3	LAN1	
4	SPDIF	Connect the SPDIF cable from external audio devices to the display for audio out.
5	MIC	Connect to a microphone.
6	AUDIO OUT	Connect to external speakers or earphones.
7	USB 2.0	Connect USB devices such as keyboards, mice, and USB flash drives.
8	USB 2.0	
9	RS232	Serial interface, used for mutual transfer of data between devices.

No.	Name	Description
10	AUDIO IN	Receive audio signals from an external device.
11	VGA	Receive analog RGB signals from an external device (such as a computer). Capable of supporting touch function.
12	HDMI 2	High-definition multimedia interface signal input. Connect to a PC with an HDMI output, a set-top-box, or other video devices. Capable of supporting touch function.
13	TOUCH-USB	Supports touch signal input from an external computer. When connecting the external computer, besides connecting the external computer's video and audio signals via their respective ports, the external computer's USB port needs to be connected to the corresponding touch port. Once the driver is installed, the external computer can be controlled via touch gestures on the display (the touch function is enabled for the VGA, HDMI, and/or DP channels by default).
14	HDMI I	High-definition multimedia interface signal input. Connect to a PC with an HDMI output, a set-top-box, or other video devices. Capable of supporting touch function.
15	DP	Connect to a PC, or audio/video equipment that supports the DisplayPort interface. Capable of supporting touch function.
16	TOUCH-USB	Supports touch signal input from an external computer. When connecting the external computer, besides connecting the external computer's video and audio signals via their respective ports, the external computer's USB port needs to be connected to the corresponding touch port. Once the driver is installed, the external computer can be controlled via touch gestures on the display (the touch function is enabled for the VGA, HDMI, and/or DP channels by default).
17	USB 3.0	Connect USB devices such as keyboards, mice, and USB flash drives.
18	USB 3.0	
19	USB 3.0	Unscrew the cover to access the USB slot for the Wi-Fi dongle.
20	OPS Slot (Port)	Supports installation of an OPS (Open Pluggable Specification) device.



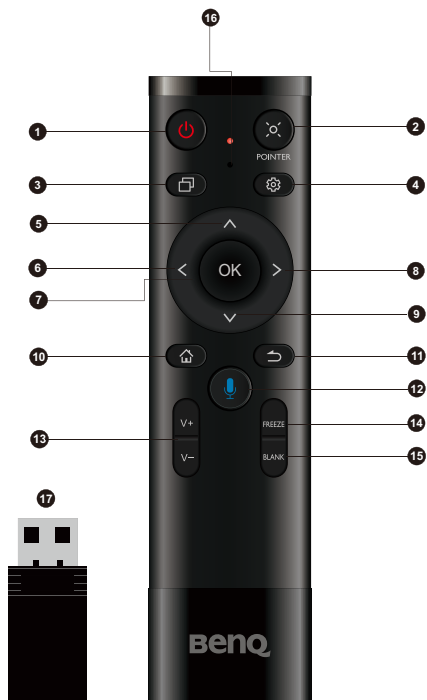

- USB2.0= 5V \equiv 500mA / USB3.0= 5V \equiv 900mA
- Type C= 20V \equiv 3A; 15V \equiv 3A; 12V \equiv 3A; 9V \equiv 3A; 5V \equiv 3A
- OPS= 18V \equiv 5A; 90W
- \equiv : Direct Current / DC
- \sim : Alternating Current /AC
- The maximum length for the cables to be used with the USB slots are 5m (USB 2.0) and 3m (USB 3.0).

Remote control





1  Turn the display on or off.

2  Pointer key. Press to activate the spotlight or pointer function and follow the instructions on the screen.

3  Press to open **Task Switcher** to switch between recent apps and input sources.

4  Press to open or close the OSD menu.

5  Direction key. Press for upward selection.

6  Direction key. Press for left selection.

7  Press to proceed.

8  Direction key. Press for right selection.

9  Direction key. Press for downward selection.

10  Android system main screen button.

11  Return key.

12  Voice command key. Press to activate Saffi (BenQ Voice Assistant), hold the button for two seconds, then say the supported command. Release the button until you finish the command.

 Speak directly to the microphone built into the top portion of the remote control. Position the microphone closer to your mouth or speak in a loud and clear voice.

13  Volume up/down.

14  Freeze screen.

15  One key for blank screen.

16  Microphone.

17  The enclosed dongle to pair with the remote control. Read [Remote control important notice on page 19](#) for more information.

Remote control important notice

1. This remote control applies only to a specific model and/or operating systems. Contact your reseller if you have any question.
2. The function keys can work only when the enclosed dongle is inserted to the BenQ Interactive Flat Panel.
3. The remote control and the enclosed dongle have been paired by default.

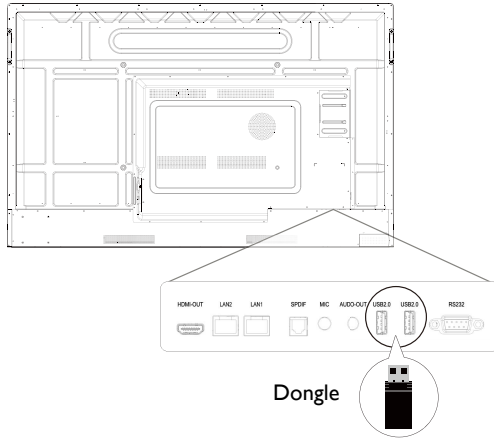

Though the remote control dongle can be installed into any of the display's USB ports, it is recommended that you install the dongle into one of the USB ports at the bottom of the rear side of the display.

Using the remote control

Installing remote control batteries

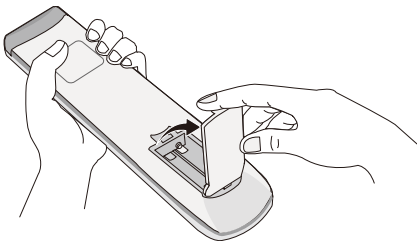

1. Open the remote control battery compartment cover.

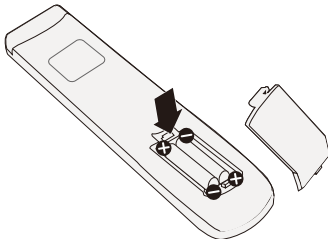

2. Insert the supplied batteries ensuring that the positive and negative marked battery terminals match the (+) and (-) marks in the battery compartment.



The supplied batteries are provided for your convenience so that you can operate the display straight away. You should replace them as soon as possible.

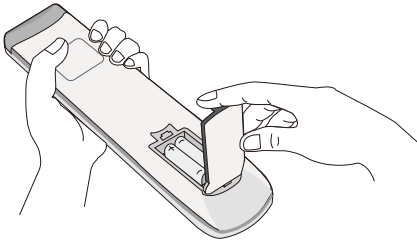

3. Re-install the battery compartment cover.

Using the BenQ Interactive Flat Panel by remote control

1. Insert the enclosed dongle into BenQ Interactive Flat Panel's USB port.

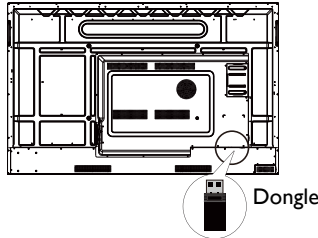

Though the remote control dongle can be installed into any of the display's USB ports, it is recommended that you install the dongle into one of the USB ports at the bottom of the rear side of the display.

2. You can activate functions on the screen once the remote control is connected to its enclosed dongle as a receiver.
3. For detailed function of each button, please refer to [Remote control on page 18](#).

Pairing the remote control and the enclosed dongle

If you are experiencing issues using the function key on the remote control, please follow the steps and pair again the remote control to resolve the issue:

1. Insert the enclosed dongle to Interactive Flat Panel's USB port and place the remote control near it.
2. Press the **V-** and **BLANK** at the same time, and the indicator light will start flashing.
3. The pairing is completed once the indicator stops flashing.

Remote control usage tips

- To power on/off the display, aim the top front of the remote control directly at the display's remote control sensor window when you press the buttons.
- Avoid getting the remote control wet or store it in humid environments (like bathrooms).
- If the display's remote control sensor window is exposed to direct sunlight or strong light, the remote control may not operate properly. In this situation, change the light source, readjust the angle of the display, or operate the remote control from a location closer to display's remote control sensor window.

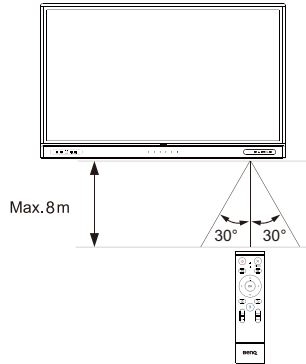

Connection

Connecting the VGA input

1. Connect the **VGA** port on the display to the VGA output port on a computer using a D-Sub (15-pin) cable.
2. Connect the computer's audio output jack to the **AUDIO IN** jack on the display with a suitable audio cable.

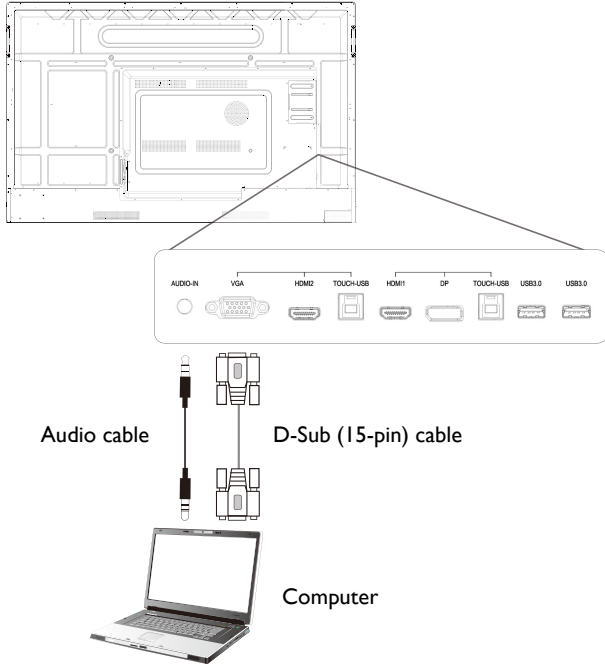

Connecting the touch module

Connect the **TOUCH-USB** port on the display to the USB port of a computer using the supplied touch USB cable. Then connect the video input port on the display that corresponds to the **TOUCH-USB** port to the video output port on the computer. The touch module of the display supports easy Plug-and-Play operation. There is no need to install additional drivers on the computer.

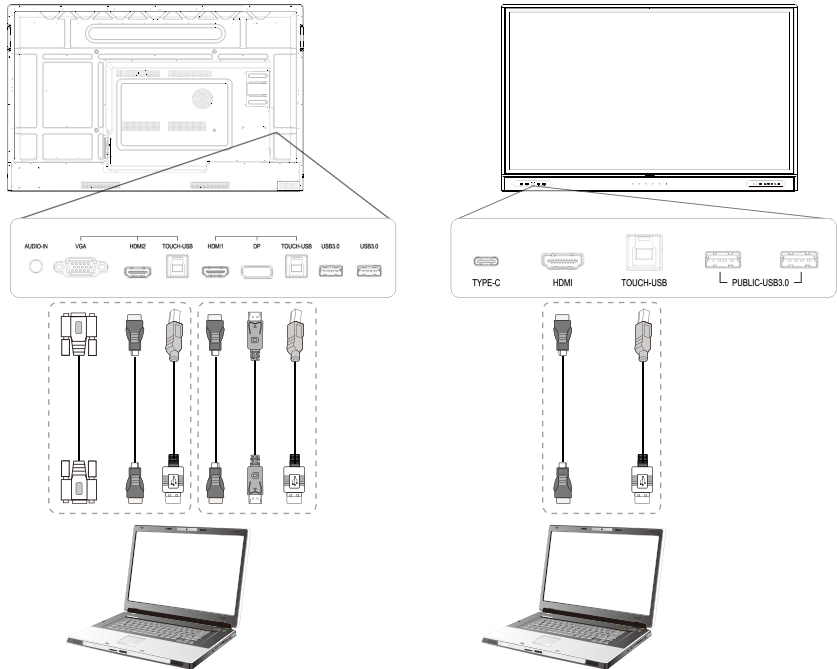

- Avoid blocking the touch screen frame (where sensors are located) when initiating the touch module.
- It is highly recommended that you connect the display to the PC or laptop directly. Avoid connecting the display to a face plate device which may cause failures in touch operations.
- If any ghost image occurs, please try to un-plug and then re-plug all USB cables. If the failure image still exists, use another USB type B to A cable.

Connecting the digital inputs

1. Connect the HDMI or DisplayPort output port of a computer or A/V device (such as a settop box or DVD player) to the **HDMI** or **DP** input port on the display using an HDMI or DisplayPort cable.
2. To view video from this input, press  on the remote control to switch to the respective input source.

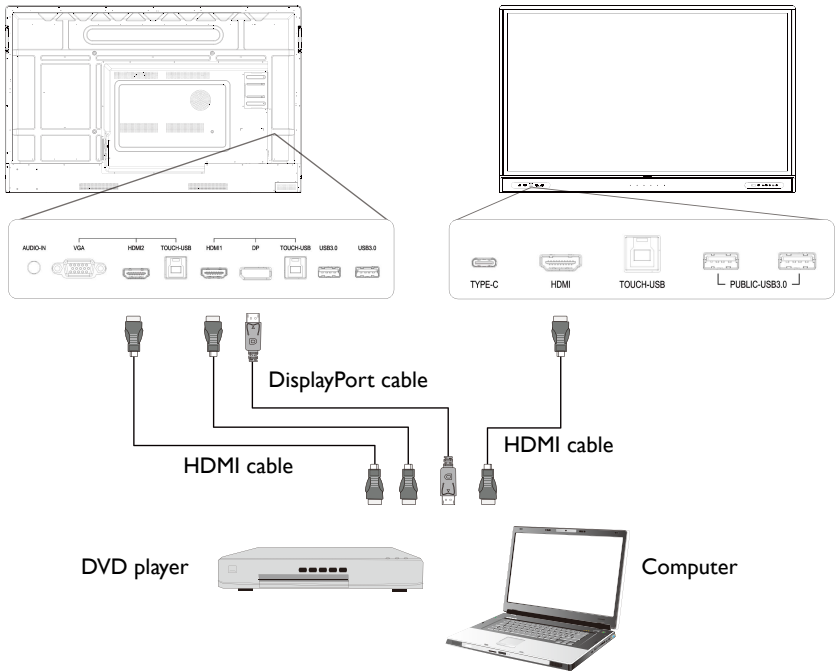

- The applicable cable is not supplied and should be purchased separately.
- The display provides a selection for the dual-monitor mode.

Connecting the video output

1. Use an HDMI cable to connect the **HDMI OUT** port to the respective input port on the device.
2. Plug in the power cord and switch the power on.
3. Press  on the remote control to turn on the display.

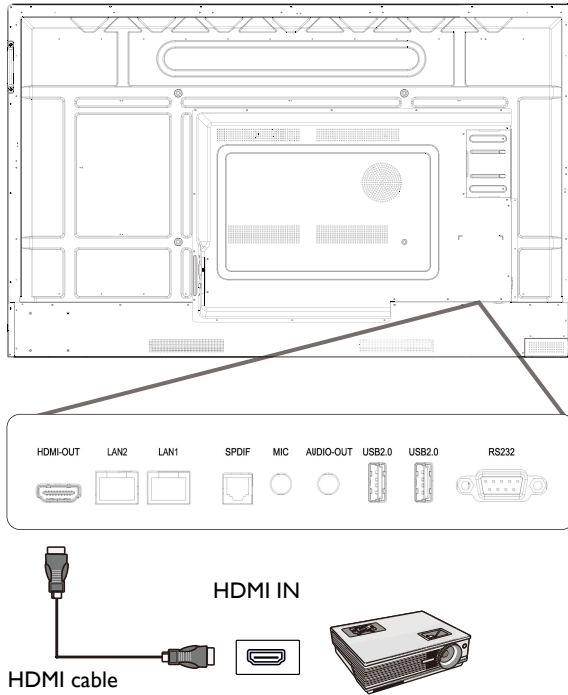

Connecting to serial port

Directly connect a computer to the **RS232** port on the input/output terminals.

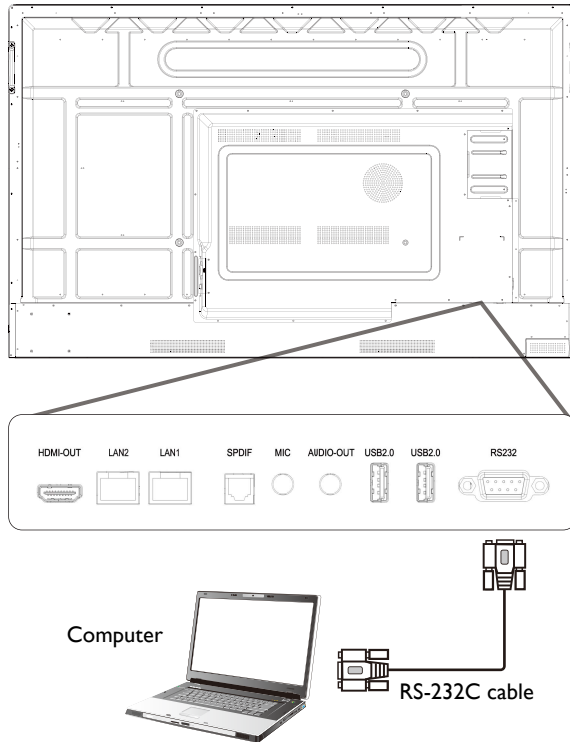

- The applicable cable is not supplied and should be purchased separately.
- This connection is applicable to straight-through RS-232C cable only.
- After using serial port line to connect central control equipment and machine, certain function of the machine can be controlled via central control equipment, such as: machine on/off, and adjustment of sound volume, etc.

Connecting power

Plug one end of the power cord into the **Power** jack on the display and the other end into an appropriate power outlet (if the outlet is switched, turn on the switch).

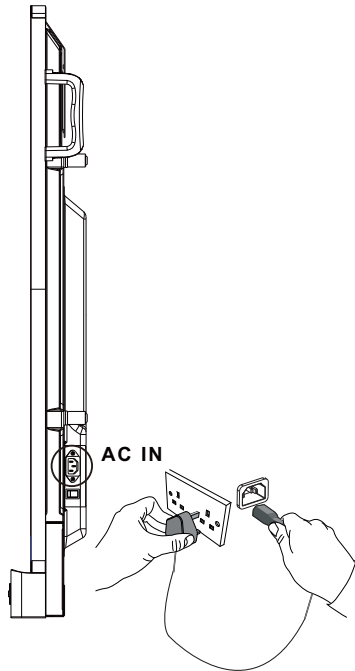

- The supplied power cord is suitable for use with 100-240V AC power only.
- The power cord and outlet illustrated may differ from the ones used in your region.
- Only use an appropriate power cord for your region. Never use a power cord which appears damaged or frayed, or change the plug type on the power cord.
- Be aware of the power loading when you use extension cords or multiple outlet power boards.
- There are no user serviceable parts in this display. Never unscrew or remove any covers. There are dangerous voltages inside the display. Turn off the power and unplug the power cord if you intend to move the display.
- The illustration is for your reference only.

Basic operations

Turning the display on or off

1. Be sure to follow the instruction of [Connecting power on page 27](#).
2. Before turning on the display, make sure the Power switch is set to **ON**. The system will enter standby mode.

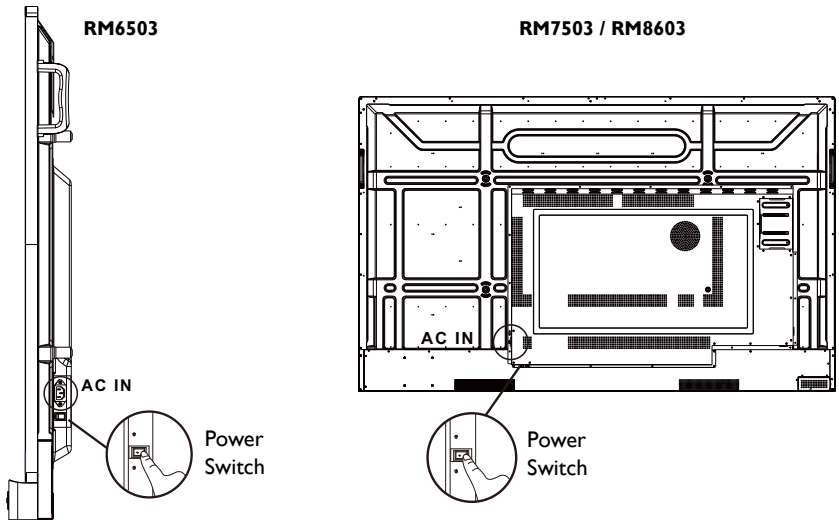

- To turn on the display, press the **Power** button on the control panel or on the remote control.
- To turn off the display, press the **Power** button on the control panel or on the remote control. The system will automatically enter standby mode.

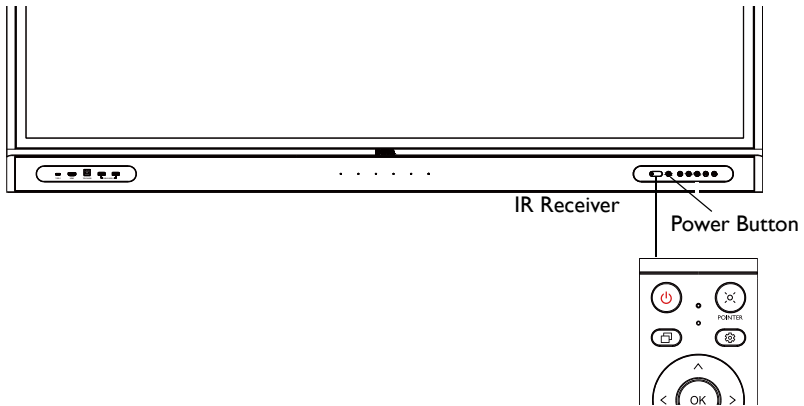

 The display's standby mode still consumes power. To completely cut off power supply, set the Power switch to OFF (O) and then disconnect the power cord from the power outlet.

Initial setup

After you have connected the display to the power, you are ready to power on the display. The first time you power on the display, you will be guided through a series of setup screens. Follow the on-screen instructions or the steps below to start up your display and complete the initial setup.

1. Turn on the display. Wait for the display to boot up with the BenQ screen. This may take a moment.
2. Tap **Next** on the screen to begin. Follow the on-screen instructions to set up the language, date and time, and network. Or you can skip some of these steps and complete the setup later.

OSD Setting

Use one of the following methods to enter the OSD menu:

- Press  on the remote control.
- Press the **Menu** button on the front panel.
- Drag the **OSD** menu up from the bottom-center of the screen.

Refer to [Menu operations on page 39](#) for more information on the OSD menus and their settings.

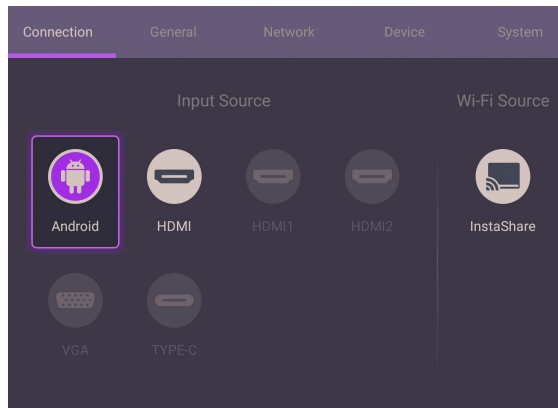

Switching input signals

Under the **Connection** tab of the OSD menu, you can select a desired input source. Refer to [Input settings on page 39](#) for more information.

Account Information

Three types of accounts are provided: Guest, Admin, and Multiple users.

Guest

It's for public use under Guest account. You are able to change the headshot, wallpaper, volume and brightness.

Admin

Log in as Admin. Under **Personal settings**, you can change the headshot, wallpaper, and password. You can also enable **AMS service**, set **Available offline accounts**, and check **Device information**.



Multiple users

Before logging in as User, be sure to enter the correct email address and activate **AMS service**.

To access your personal account, you have to ask the administrator to activate AMS service first and create your account through **IAM** service. Refer to [User Management on page 31](#) for more information.

For more information and tutorial videos about the AMS service please visit <https://www.benq.com/en-us/business/ifp/account-management-system.html>.

User Management

To add a new user, please contact your IT manager to create your account through BENQ IAM web service.

Creating a new account

1. As an administrator to create a new account for regular users, go to BenQ Service website: <https://iam.benq.com>. Suggested browsers are Chrome and Firefox.
2. Log in and choose **IAM**.

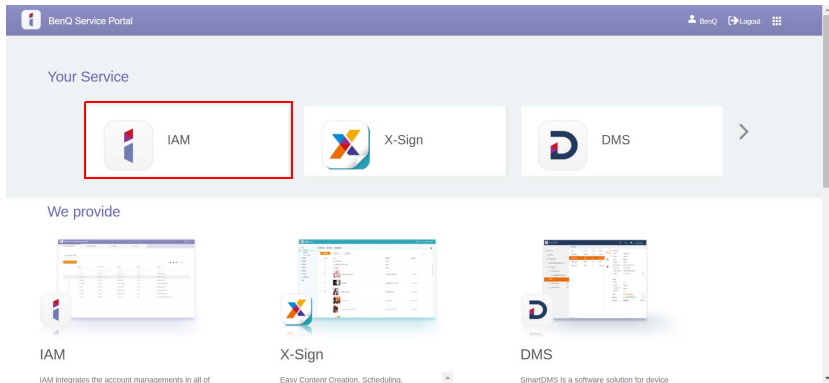

3. Click **Create New Account** to continue.

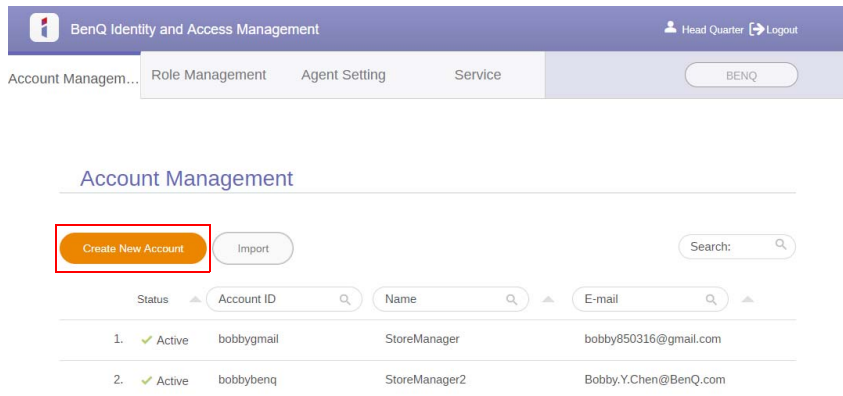

4. Fill in the following fields. Be sure to enter the correct email address. Click **Submit** to create a new account.



If some members in your organization need more privilege to control the AMS service, you can activate the users as other roles. You can also activate **X-Sign**, **DMS**, and/or **Broadcast** when creating user accounts.

The screenshot shows the 'Create New Account' page in the BenQ Identity and Access Management system. The page has a navigation bar with 'Account Management', 'Role Management', 'Agent Setting', and 'Service'. The 'Create New Account' form contains the following fields: E-mail, Account ID, Password, Confirm Password, Name, Company (pre-filled with 'BenQ'), Country/Area (pre-filled with 'Taiwan'), Timezone (pre-filled with 'UTC+08:00 Taipei'), and a Note field (with a 'within 150 characters' hint). To the right, the 'Service Setting' section has a checkbox for 'Set this account as substitute administrator, has all of the permissions, two accounts at most'. Below this, there is a table to enable services:

Enable Service	Role	Action
<input checked="" type="checkbox"/>	X-Sign Schedule Manager	Create a new role
<input type="checkbox"/>	DMS Guest	Create a new role
<input type="checkbox"/>	AMS User	Create a new role
<input checked="" type="checkbox"/>	Broadcast	

At the bottom right, there is a 'Submit' button (highlighted with a red box) and a 'Cancel' button.



You can easily switch to different services, **X-Sign**, **DMS**, and **Broadcast** by clicking the icon on the upper right corner.

5. The account has been created and a verifying email is sent to the new account owner.



The account has been created. We'll send the email from "BenQ". If it isn't in your inbox, check your folders. If a spam filter or email rule moved the email, it might be in the Spam, Junk, Trash, Deleted items, or Archive folder.

Close

Setting up the Internet connection

Your display must be connected to a network to conduct OTA updates or surf the Internet.



To find the MAC address in Android OS, please go to **Setting > System > About > Status**.

Network setting

On the home screen, go to **Setting > System > About > Status**. If there is no IP address shown, please connect the display to the ethernet cable.

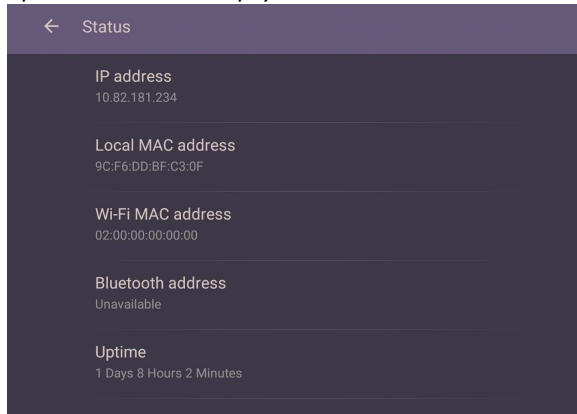

Wireless connection

You must use a wireless adapter in order to connect the display to the Internet wirelessly. Please contact your local dealer for more information on configuring the wireless connection.

1. Press  on the remote control, or go to **Network > Wi-Fi**.

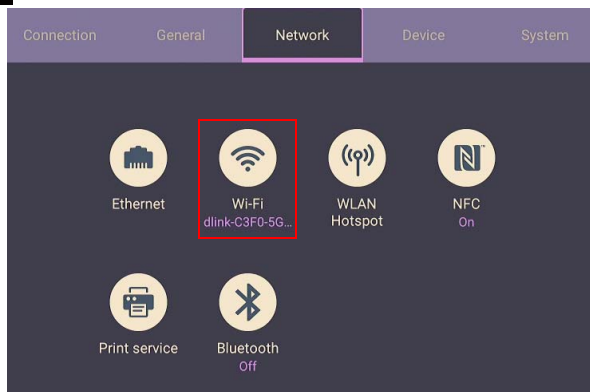

2. Insert the Wi-Fi dongle and the switcher will automatically change to **ON**. A list of available networks will show on the screen.



3. Touch the network's name to connect to the network. The password is needed if it is your first time to use the network. Key in the password and press **Connect**. The device is now connected to the WLAN.



- If you are connecting to a secured wireless network, enter the password for the wireless network access when prompted and tap **Connect**.
- For wireless connection, BenQ shipment does not include wireless dongles; therefore, you may purchase it separately via the local dealer.

Updating software

Whenever a new version of software is available, the system will automatically detect the update and will prompt you to download it every time you turn on the display. If you want to update the software, choose **NETWORK UPDATE** or **USB UPDATE** to continue the update. Or you can skip this step and update the software later.

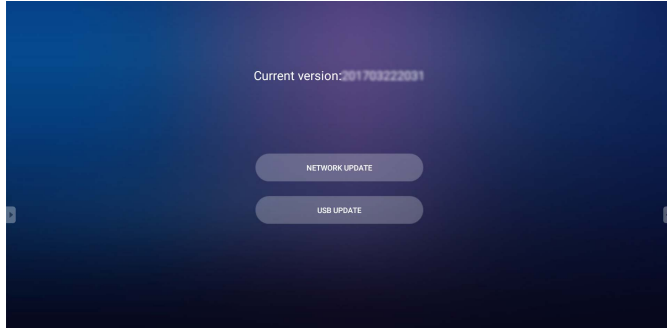

To manually update the software:

1. Go to **System > About > System updates**.

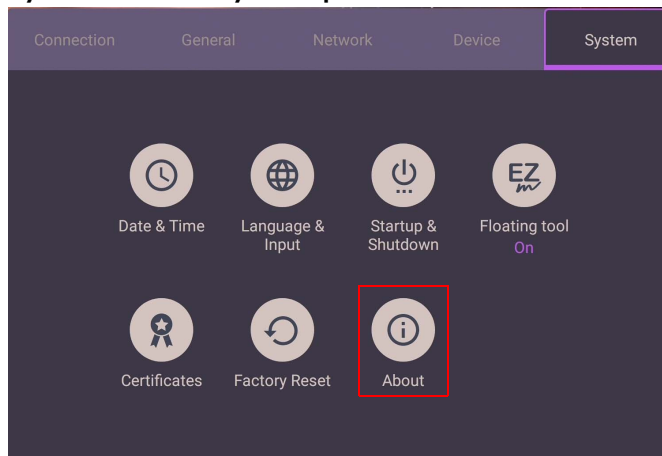

2. If there is an update available, the system will begin updating.



- Software update process may take some time to complete.
- During the update process, do not turn off the device or disconnect the Internet connection. Any interruptions during the software update process may permanently damage your display.

Adjusting audio volume level

To adjust the audio volume level do either one of the following:

- Press **V+** / **V-** on the remote control to adjust the volume.
- Press **🔊** / **🔊** on the front panel of the display.
- Go to **Setting > General** to adjust the volume. Refer to [General settings on page 40](#) for more information.

Using the touch screen

You can use the optical touch screen to control your operating system. The touch screen can emulate basic mouse functions and supports multi-touch functions. The following table shows a list of gestures you can use on the touch screen.

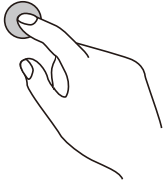
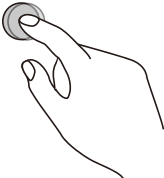
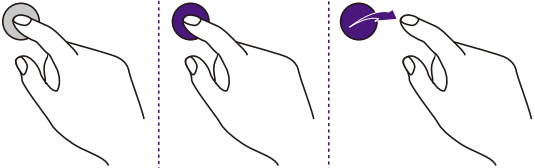
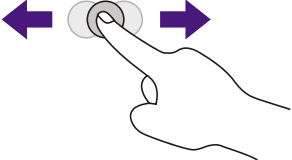

Make sure that you have installed the touch USB cable on the display to a computer.

OS functions	Gesture actions
Click	Tap the screen once. 
Double-click	Tap the screen twice. 
Right-click	<ol style="list-style-type: none"> 1. Press on the target. 2. Hold and wait for a blue ring to appear. 3. Release your finger. 
Drag	Drag one finger left or right. 

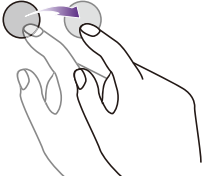
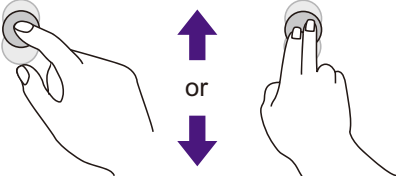
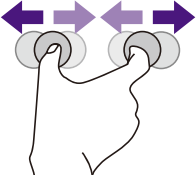
OS functions	Gesture actions
Pan up / Pan down / Back / Forward	Quickly drag your finger (Flick) in a desired direction. 
Scrolling	Drag one or two fingers up or down. 
Zoom	Move two fingers apart or toward each other. 

Important instructions for using the touch screen

Please clean the frame when there is sign of malfunction on the touch screen.

- Before you clean the screen, make sure the display is turned off, and unplug the power cord.
- Remove dust or dirt from the screen and the infrared plastic filter periodically. It is suggested using a small amount of alcohol to clean the infrared plastic filter.
- To avoid damage to the screen, never use any type of abrasive materials to wipe the screen.
- Use a neutral detergent to clean the touch screen. Avoid using detergents with erosive substance, such as banana oil or ammonia.
- Moisten a clean soft, lint-free cloth with a neutral detergent and then clean the touch screen.
- Do not spray a detergent on the screen surface or the body directly. It may result in a short circuit to the touch screen.
- Keep the touch screen out of direct sunlight or spotlights.

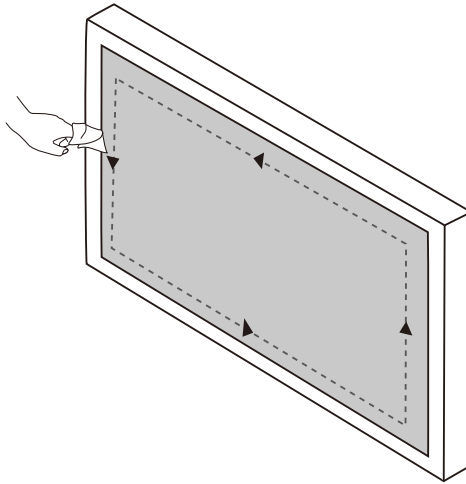

Menu operations

One touch menu operation

Drag the **OSD** menu up from the bottom-center of the screen, as shown below, to enter the **OSD** menu.

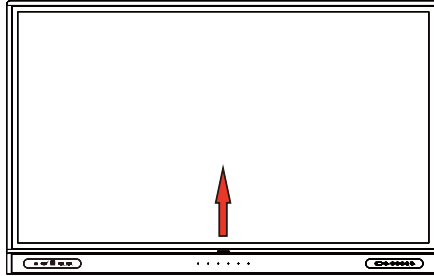



Settings menu

Input settings

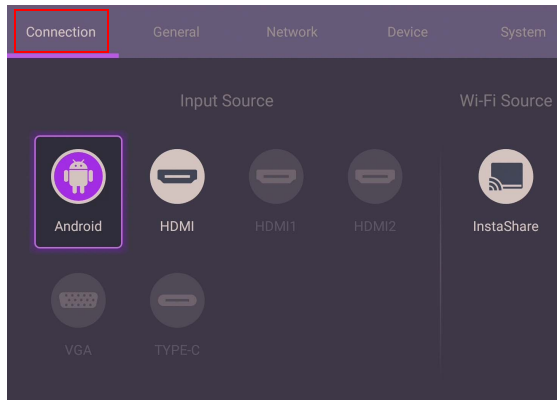
Press  on the remote control, **Menu** on the front panel, or drag from the bottom middle to the center of the screen to enter the **OSD** menu.



- Press  on the remote control and press **OK** to confirm, or directly click a desired input source.
- Press  on the remote control or click a blank area outside the menu to exit the menu.

General settings

Go to **General** to access the Audio and Picture settings.

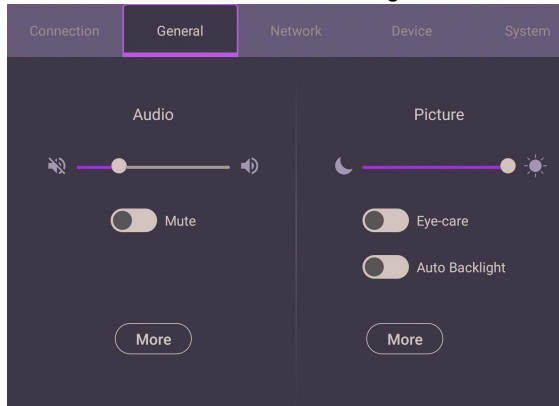

Audio

- Under Audio, Use the volume bar to adjust the volume for the display.
- Directly swipe to enable or disable **Mute**.
- Go to **More** to enter the Audio menu.

Picture

- Under Picture, use the brightness bar to adjust the brightness for the display.
- You can enable the **Eye-Care** function on the OSD menu. **Eye-Care** switches the display's low blue light mode.
- Directly swipe to enable or disable **Auto Backlight**.
- Go to **More** to enter the Picture menu.

Eye-Care solutions

Blue light with wavelengths under 455 nm could affect vision. **Eye-Care** solution is designed for eyesight protection: the display provides proprietary eye-care technology with ultra-low blue light emission and no visible or invisible flicker within the range of 0-3000Hz, preventing eyestrain caused by extended sessions in front of a display. In addition, advanced anti-glare screen treatment minimizes distracting reflections and glare for optimal productivity and comfort.



Suggestions for long-term use of the display:

- Rest your eyes for 10 minutes after 30 minutes of continuous use.
 - For every 20 minutes of display viewing, look into the distance for 20 seconds.
 - When your eyes get sore and strained, close your eyes for a minute and then roll your eyes in all directions.
-

To activate the smart eye care solution, enable the **Eye-Care** function under **General**.

Low blue light & flicker free:

- To accord with Low blue light TUV certificated, the default setting is **Picture Mode: Standard, Brightness: 50, Contrast: 50, and Color Temperature: Standard**, and then enable **Eye-Care** function.
 - To accord with Flicker Free TUV certificated, the default setting is **Picture Mode: Standard, Brightness: 50, Contrast: 50, and Color Temperature: Standard**.
-



For more information about Picture settings, refer to [Picture settings on page 43](#).

Audio settings

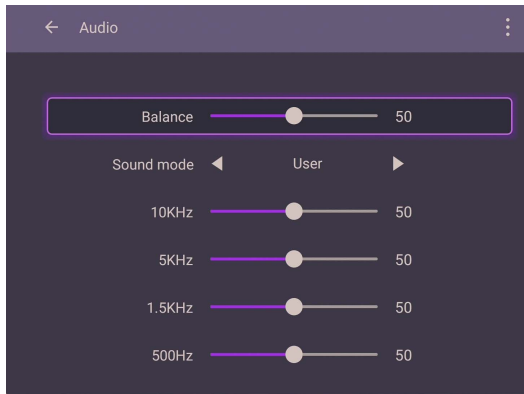
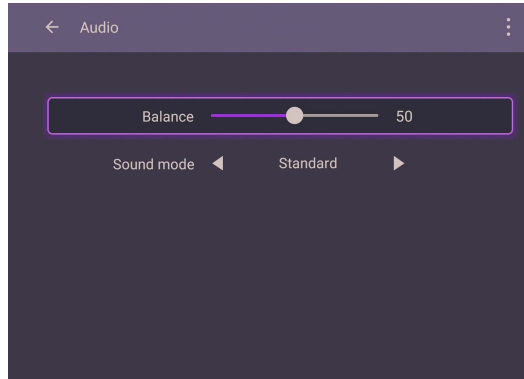

- Press **▲/▼/◀/▶** on the remote control and press **OK** to confirm or directly click an item.
- Press **↩** on the remote control or click a blank area outside the menu to exit the menu.

Menu	Description
Balance	Drag the knob to adjust the balance.
Sound Mode	<ul style="list-style-type: none"> • Touch a preset sound environment. Options are Standard, News, Music, Movie, Sport, or User mode. • Under User mode, you can adjust 10KHz, 5KHz, 1.5KHz, 500Hz.

Picture settings

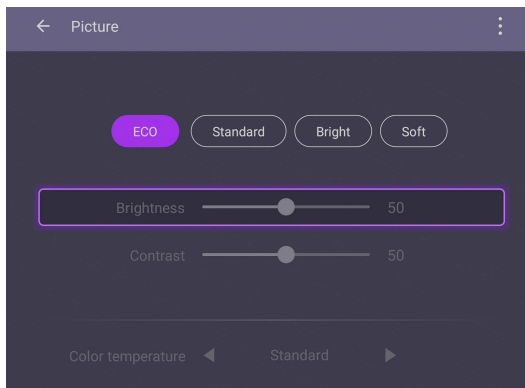
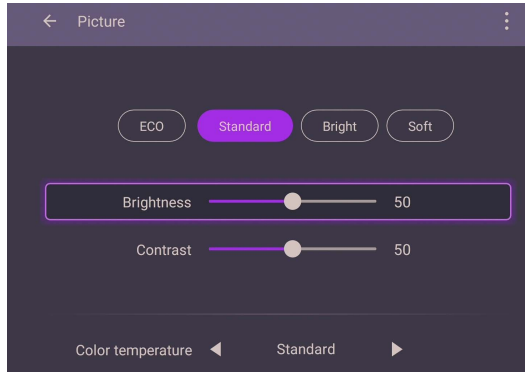

- Press \blacktriangle / \blacktriangledown / \blacktriangleleft / \blacktriangleright on the remote control and press **OK** to confirm or directly click an item.
- Press \blacktriangleright on the remote control or click a blank area outside the menu to exit the menu.

Menu	Description
Picture Mode	<ul style="list-style-type: none"> • Press \blacktriangle/\blacktriangledown/\blacktriangleleft/\blacktriangleright on the remote control or click a picture mode. Options are Eco, Standard, Bright, and Soft. • Under Eco mode, Brightness level, Contrast, and Color Temperature are locked.
Brightness level	Under Standard , Bright , and Soft mode , press \blacktriangleleft / \blacktriangleright on the remote control or drag the knob to adjust the brightness.
Contrast	Under Standard , Bright , and Soft mode , press \blacktriangleleft / \blacktriangleright on the remote control or drag the knob to adjust the contrast.
Color Temperature	Press \blacktriangle / \blacktriangledown / \blacktriangleleft / \blacktriangleright on the remote control or click a preset color temperature for the image. Options are Standard , Cool , and Warm .

Device settings

Go to **Device** to access the Device settings.

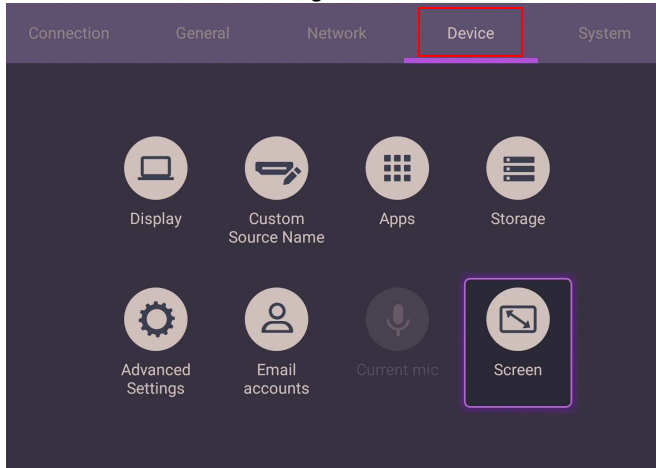

Menu	Description
Display	Allows you to adjust the display's parameters. Refer to Display settings on page 45 for more information.
Custom Source Name	Allows you to set unique names for each input source.
Apps	Accesses all the applications installed in the display.
Storage	Allows you to manage the display's storage.
Advanced Settings	Accesses more device settings. Refer to Advanced settings on page 46 for more information.
Email Accounts	Sets the display's email accounts for 3rd party email applications.
Current Mic	Displays current microphone information.
Screen	Allows you to adjust the display's image settings. Refer to Screen settings on page 47 for more information.

Display settings

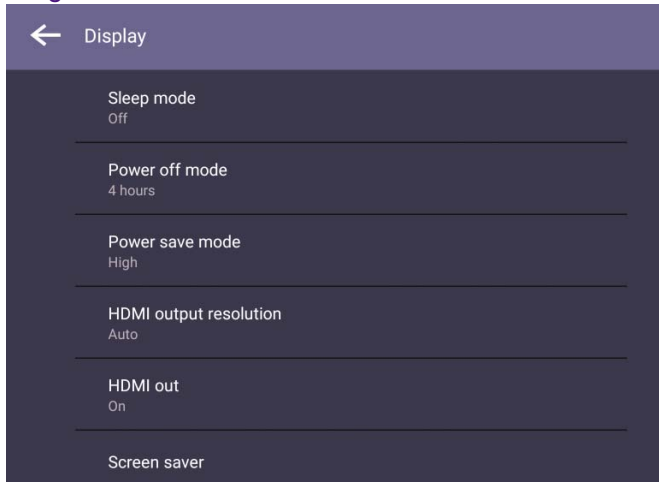

- Press **▲/▼/◀/▶** on the remote control and press **OK** to confirm or directly click an item.
- Press **⏪** on the remote control or click a blank area outside the menu to exit the menu.

Advanced settings

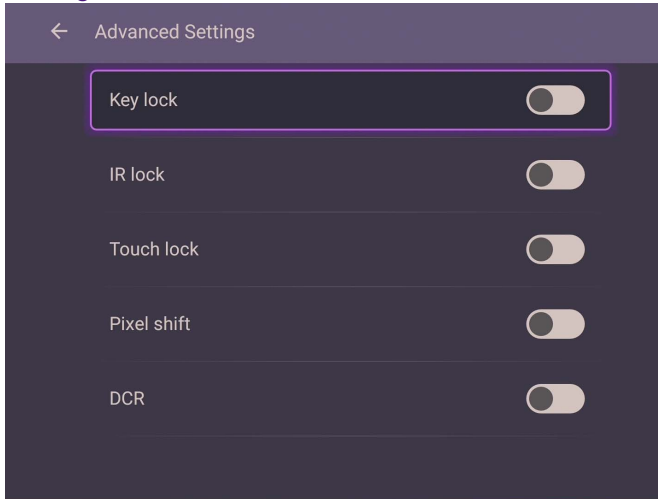

- Press **▲/▼/◀/▶** on the remote control and press **OK** to confirm or directly click an item.
- Press **⏪** on the remote control or click a blank area outside the menu to exit the menu.

Menu	Description
Key lock	Press OK on the remote control or click the switch to lock or unlock the buttons on the front panel of the display.
IR lock	Press OK on the remote control or click the switch to lock or unlock the remote control IR sensor on the front panel of the display.
Touch lock	Press OK on the remote control or click the switch to lock or unlock the screen.
Pixel shift	Press OK on the remote control or click the icon to set a pixel shift preventing from image retention.
DCR	Press OK on the remote control to enable or disable DCR .



- If keypad, IR and touch are locked all at once, please follow the steps to unlock: Press  on the remote control for five seconds.
- For image retention, please see [Notes on the LCD panel of this display on page 7](#) for more information.

Screen settings

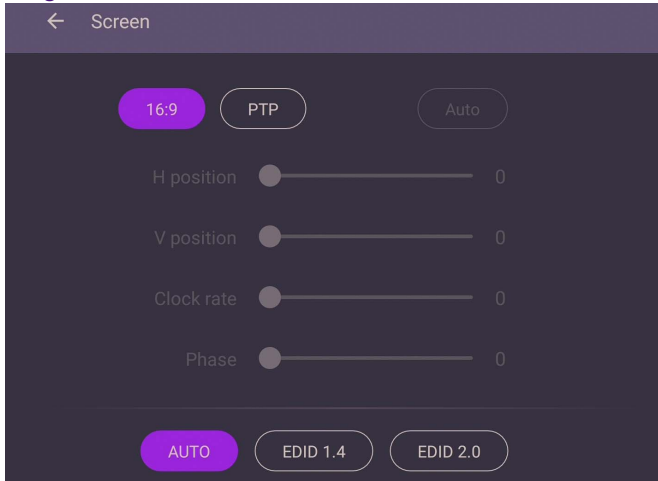

- Press **▲/▼/◀/▶** on the remote control and press **OK** to confirm or directly click an item.
- Press **⏪** on the remote control or click a blank area outside the menu to exit the menu.
- Press **◀ / ▶** on the remote control and press **OK** to adjust image.

Menu	Description
Aspect ratio	Press ◀ / ▶ on the remote control or click an aspect ratio. Options are 16:9 or PTP . You can also select Auto to automatically adjust the image.

- Use the **H position**, **V position**, **Clock rate**, and **Phase** functions to manually adjust the image.

Menu	Description
H position	Press to move the screen to the left or right.
V position	Press to move the screen to the top or bottom.

System settings

On the home screen, select **Setting > System** to enter system settings.

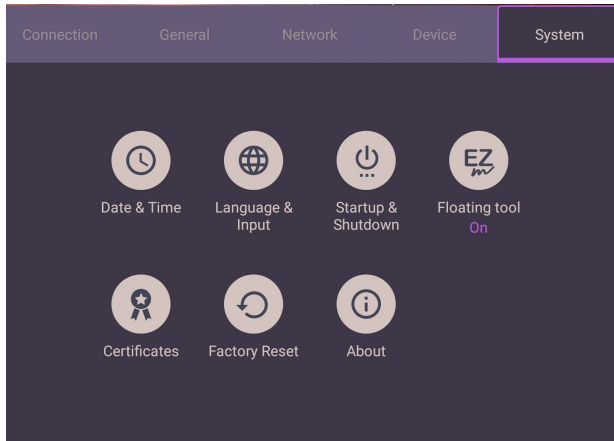

- Press  on the remote control or click a blank area outside the menu to exit the menu.

Options	Description
Date & Time	Click to set date, time, and their formats in Android.
Language & input	Click to set Language, Keyboard & Input methods in Android.
Startup & Shutdown	Click to set the Startup channel, OPS startup option, Wake on Lan, and Power off reminder . Refer to Startup & Shutdown on page 50 for more information.
Floating tool	Click to open and close the floating tool. Refer to EZ Floating Tool on page 54 for more information.
About	Click to view system information in Android.



The amount of available storage space for the user varies according to the amount of pre-installed apps and images occupying the total storage space.

Proxy setting

- Go to **Network > Ethernet**.

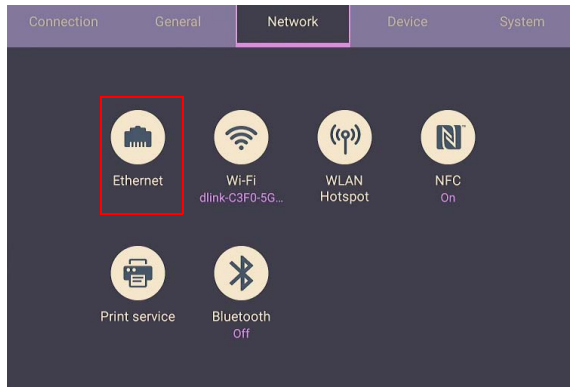

- Press **Proxy** to go to the proxy setting.

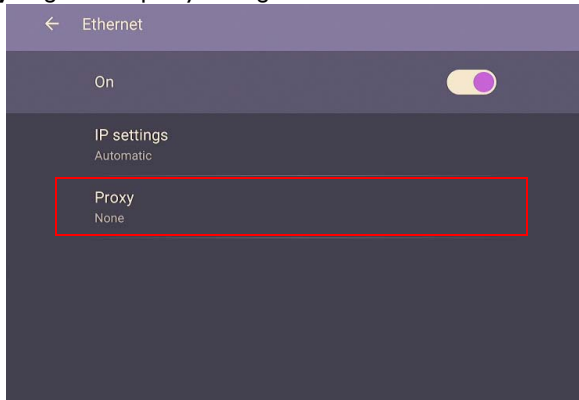

- Enter the proxy host name.
- Enter the using channel.

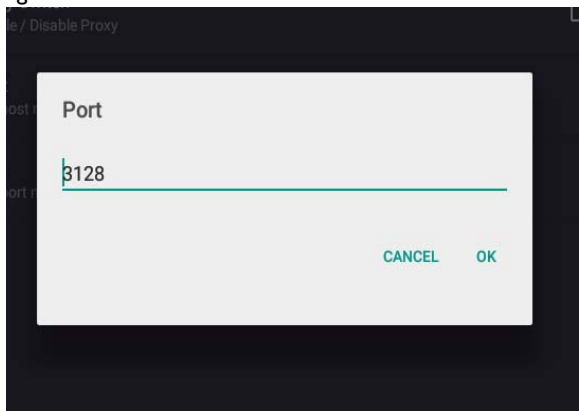

Startup & Shutdown

- Go to **System > Startup & Shutdown**.

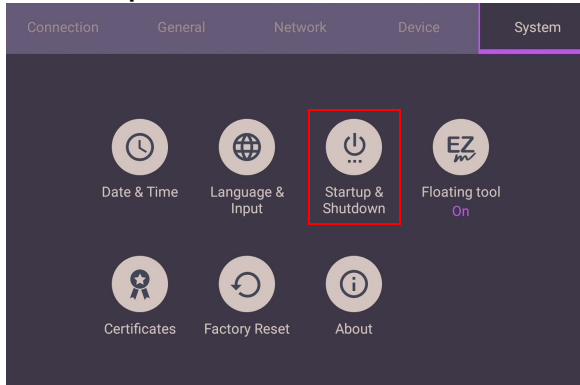

- For **Startup channel**, you can choose **Last channel** or other sources.

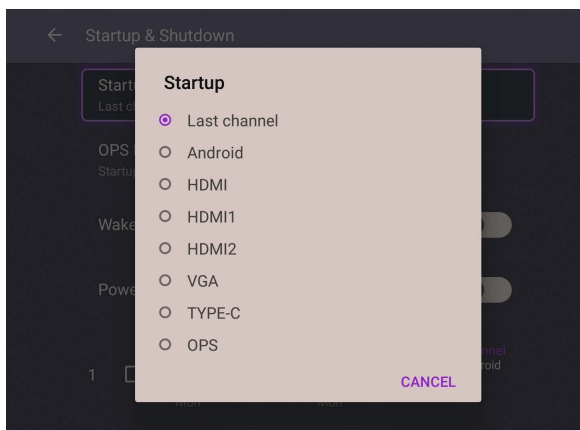
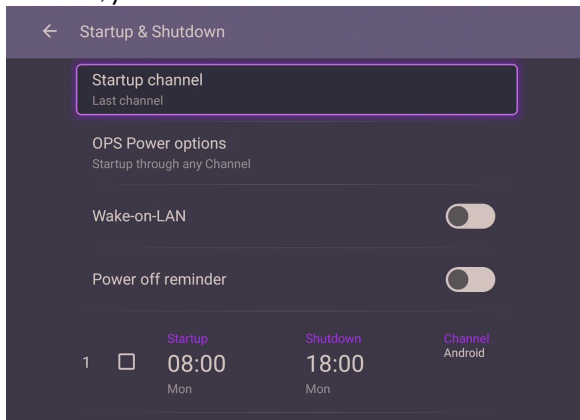

- For **Built-in OPS startup option**, you can choose **Startup only through OPS built-in startup option** or **startup through any channel**.

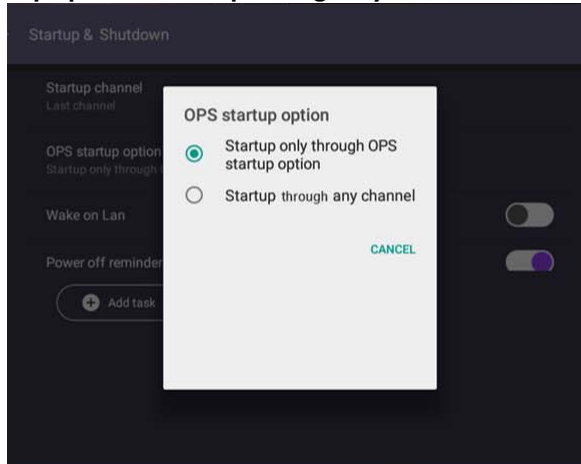

- For **Power off reminder**, you can set on or off time. Schedules can be made by choosing the days of the week.

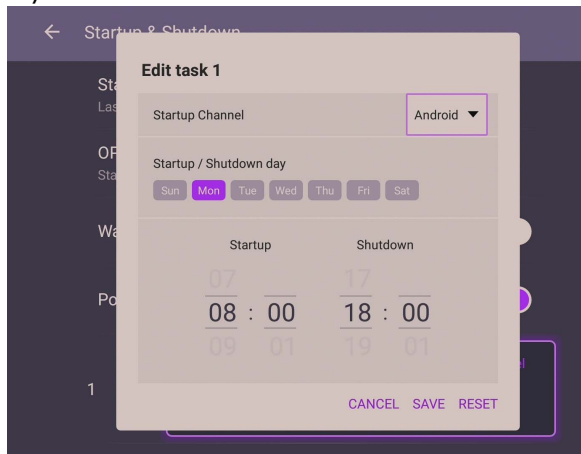



Android system interface







Note that this is a closed Android OS. Download and use of unauthorized apps on this system are not available.

Main interface

The display launches the Android main interface by default. To navigate the Android main interface:

- Press  on the remote control or **Home** button on the front panel to return to the main interface.
- Press  on the remote control or drag the **OSD** menu up from the bottom-center of the screen to enter the **OSD** menu to select an input.









Icon	Function	Description
	Source	Press to enter the Connection menu to set input source.
	OSD Settings	Press to open or close the OSD settings menu.
	All Apps	Press to access all apps and widgets.
	Help	Press to access on-line tutorial videos and manuals(Available by 2022 Q2).

Side tool bar

Tap the side bars at the left or right of the main interface to access the side tool bar.



You may drag the tool to the top or bottom of the screen to suit your preference.

Icon	Function	Description
	Back	Tap to return to the previous screen.
	Home	Tap to return to the main interface.
	Task Switcher	Tap to switch between recent apps and input sources.
	EZ Floating Tool	Tap to open the floating annotation tool.
	Duo Window	Tap to run two apps side by side (Available by 2022 Q2).
	EZWrite	Tap to enter EZWrite annotation software.











EZ Floating Tool

The **EZ Floating Tool** is a convenient function that allows you to quickly write or create annotations on any screen that the display is showing.

To access the floating tool use either one of the following methods:



- In the Android interface, tap  in the side tool bar.
- Under any input source or in the Android interface, touch and hold two fingers spaced about 20 – 50 mm apart on the screen for more than two seconds to launch the **EZ Floating Tool** menu as shown below.



Icon	Function	Description
	Close/Minimize	<ul style="list-style-type: none"> • Click to close the floating tool. • Click to minimize the floating tool bar when EZWrite 6 is in use.
	Highlighter	Click to enable the Highlighter tool.  The highlighter provides 5 color selections (red, yellow, green, blue, and black) and supports thickness adjustment.
	Laser Pointer	Click to enable the laser point on the screen.
	Eraser	Click to erase annotations on the screen. You may use a finger eraser or choose to clear all annotations.
	Tool Box	Click to open the tool box which includes the Calculator, Timer, Stopwatch, Scoreboard, and Draw tools.
	Recording	Click to start recording the screen.
	Screenshot	Click to take a screenshot of the screen.
	Operation Mode	Click to hide all the annotations and operate the main interface.
	Pen	Click to enable the Pen tool.  The pen has a round point by default. It provides 5 color selections (red, yellow, green, blue, and black) and supports thickness adjustment.

AMS file manager overview

With this application, you can access your personalized workspace environment and settings, and manage your files and accounts on any IFP that you have logged into. To access the AMS files use either of the following methods:



- Tap the file manager shortcut .
- Tap the AMS shortcut .

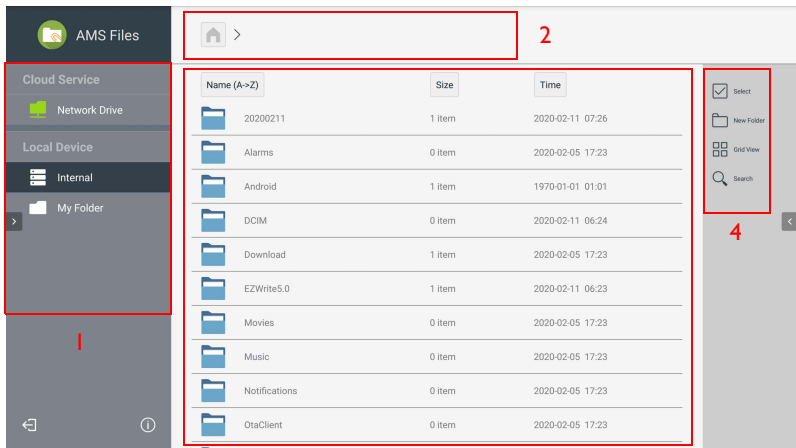

While logging in, you will see four main parts, as described in the table below:



3

Item	Description
1. Source Selection	<ul style="list-style-type: none"> You can open files from the cloud storage services like Google Drive, Dropbox, or Samba. You can also open files from the local devices like Internal, My Folder, or connected USBs. <p> The icon  next to Google Drive, Dropbox shows that the account is bound to AMS service.</p>
2. Folder Path	You can browse the file folder in this area.
3. Listing Files	You can see a list of files from the storage device you select.
4. Operating Tab	You can edit the files using the operating tabs here.
	Regular users can only view their own files, while the local admin can view all users' files in the domain.

Multimedia files

Multimedia files such as images, audio files, and videos can be played by directly tapping on the file icon.

Image

Select an image file you want to show on the display and perform any of the functions shown on the screen.

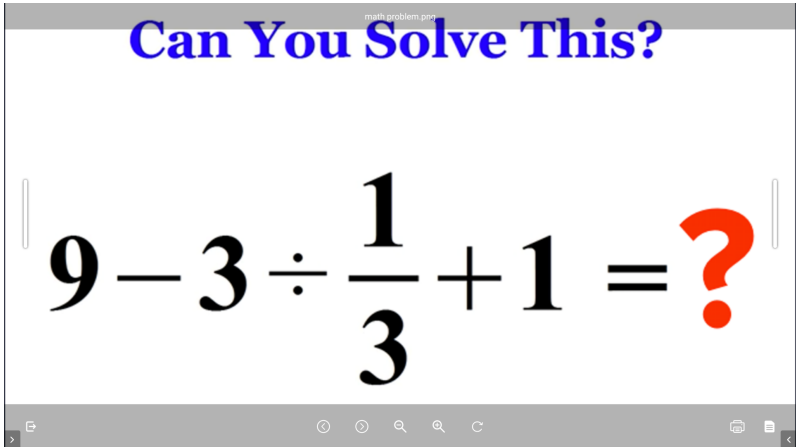

Icon	Function
	Exits the image viewer.
	Plays the previous image file.
	Plays the next image file.
	Magnifies the current image.
	Shrinks the current image.
	Rotates the current image clockwise.
	Prints out the image.
	Displays file information, including name, creation time, file size, and file format.

Supported image format (maximum resolution)

Image	Photo	Resolution	Maximum Resolution
JPEG	Base-line	1920×1080	15360×8640
	Progressive	1024×768	7000×7000

Image	Photo	Resolution	Maximum Resolution
PNG	Non-interlace	1920x1080	9600x6400
	Interlace	1920x1080	9600x6400
BMP	-	9600x6400	9600x6400



The limitation of max resolution depends on DRAM size.

Audio/Video

Select an audio/video file you want to play on the display and perform any of the functions shown on the screen.

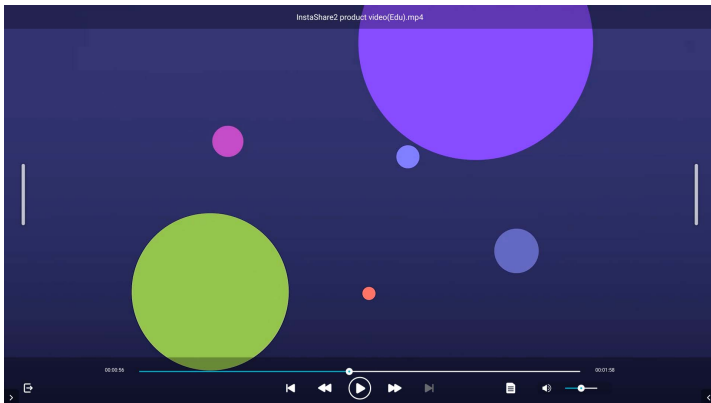

Icon	Function
	Exits the audio/video player.
	Plays the previous audio/video file.
	Rewinds the audio/video.
	Plays/pauses the current audio/video file.
	Fast forwards the audio/video.
	Plays the next audio/video file.
	Displays file information, including name, creation time, file size, and file format.
	Adjusts the audio/video volume.

Supported audio format (Codec)

Audio Codec	Sample Rate	Channel	Bit Rate	Container
MPEG1/2 Layer 1	16-48KHz	Up to 2	32-448Kbps	MP3 (.mp3), AVI (.avi), ASF (.asf), WMV (.wmv), DivX (.divx), MKV (.mkv, .mka), WebM (.webm), 3GPP (.3gpp, .3gp), MP4 (.mp4, .mov, .m4a), MPEG transport stream (.ts, .trp, .tp), MPEG program stream (.dat, .vob, .mpg, .mpeg), FLV (.flv), WAV (.wav), OGM (.ogm)
MPEG1/2 Layer 2	16-48KHz	Up to 2	8-384Kbps	MP3 (.mp3), AVI (.avi), ASF (.asf), WMV (.wmv), DivX (.divx), MKV (.mkv, .mka), WebM (.webm), 3GPP (.3gpp, .3gp), MP4 (.mp4, .mov, .m4a), MPEG transport stream (.ts, .trp, .tp), MPEG program stream (.dat, .vob, .mpg, .mpeg), FLV (.flv), WAV (.wav), OGM (.ogm)
MPEG1/2/2.5 Layer 3	8-48KHz	Up to 2	8-320Kbps	MP3 (.mp3), AVI (.avi), ASF (.asf), WMV (.wmv), DivX (.divx), MKV (.mkv, .mka), WebM (.webm), 3GPP (.3gpp, .3gp), MP4 (.mp4, .mov, .m4a), MPEG transport stream (.ts, .trp, .tp), MPEG program stream (.dat, .vob, .mpg, .mpeg), FLV (.flv), WAV (.wav), OGM (.ogm)
AAC-LC, HEAAC	8-48KHz	Up to 5.1	16-576Kbps	AAC (.aac), AVI (.avi), MKV (.mkv, .mka), WebM (.webm), DivX (.divx), 3GPP (.3gpp, .3gp), MP4 (.mp4, .mov, .m4a), MPEG transport stream (.ts, .trp, .tp), MPEG program stream (.dat, .vob, .mpg, .mpeg), FLV (.flv), RM (.rm, .rmvb, .ra), WAV (.wav), WMV (.wmv)

Audio Codec	Sample Rate	Channel	Bit Rate	Container
VORBIS	6-48KHz	Up to 5.1	8-500Kbps	MKV (.mkv, .mka), WebM (.webm), 3GPP (.3gpp, .3gp), MP4 (.mp4, .mov, .m4a), Ogg (.ogg), WMV (.wmv), ASF (.asf), AVI (.avi)  Supports stereo decoding only.
LPCM	6-192KHz	Mono, stereo	N/A	WAV (.wav), AVI (.avi), MKV (.mkv, .mka), WebM (.webm), 3GPP (.3gpp, .3gp), MP4 (.mp4, .mov, .m4a), MPEG transport stream (.ts, .trp, .tp), MPEG program stream (.dat, .vob, .mpg, .mpeg), WMV (.wmv), ASF (.asf), FLV (.flv), OGM (.ogm)
LBR (cook)	8KHz, 11.025KHz, 22.05KHz, 44.1KHz	Up to 2	8-96.469Kbps	RM (.rm, .rmvb, .ra)
FLAC	8-192KHz	Up to 5.1	128-2304Kbps	MKV (.mkv, .mka), WebM (.webm), FLAC (.flac)
OPUS	8-48KHz	Up to 5.1	6-510Kbps	MKV (.mkv, .mka), WebM (.webm)
APE	32KHz, 44.1KHz, 48KHz	Up to 2	500Kbps-1.5Mpb	APE (.ape)
AMR-NB	8KHz	1	4.75-12.2Kbps	3GPP (.3gpp, .3gp), MP4 (.mp4, .mov, .m4a)
AMR-WB	16KHz	1	6.6-23.85Kbps	3GPP (.3gpp, .3gp), MP4 (.mp4, .mov, .m4a)

Supported video format (Codec)

Video Codec	Resolution	Bit Rate	Profile	Container
VP9	4096x2160 @60fps	60Mbps	<ul style="list-style-type: none"> Profile 0 (420, 8bit) Profile 2 (420, 10bit) 	MKV (.mkv), WebM (.webm)

Video Codec	Resolution	Bit Rate	Profile	Container
HEVC/H.265	4096x2160 @60fps	200Mbps	Main/Main 10 Profile, High Tier@Level 6.1	MP4 (.mp4, .mov), 3GPP (.3gpp, .3gp), MPEG transport stream (.ts, .trp, .tp), MKV (.mkv), WebM (.webm), FLV (.flv), AVI (.avi), H265 (.265)
MPEG1/2	1920x1080 @60fps	80Mbps	MP@HL	MPEG program stream (.dat, .vob, .mpg, .mpeg), MPEG transport stream (.ts, .trp, .tp), MP4 (.mp4, .mov), 3GPP (.3gpp, .3gp), AVI (.avi), MKV (.mkv), WebM (.webm), ASF (.asf), WMV (.wmv), OGM (.ogm)
MPEG4	1920x1080 @60fps	80Mbps	<ul style="list-style-type: none"> • Simple Profile • Advanced Simple Profile@Level 5  GMC is not supported.	MP4 (.mp4, .mov), 3GPP (.3gpp, .3gp), AVI (.avi), MKV (.mkv), WebM (.webm), ASF (.asf), WMV (.wmv), FLV (.flv), OGM (.ogm), MPEG transport stream (.ts, .trp, .tp), MPEG program stream (.dat, .vob, .mpg, .mpeg)
Sorenson H.263	1920x1080 @60fps	80Mbps	N/A	FLV (.flv), AVI (.avi)
H.263	1920x1080 @60fps	80Mbps	N/A	FLV (.flv), MP4 (.mp4, .mov), 3GPP (.3gpp, .3gp), AVI (.avi), ASF (.asf), WMV (.wmv)
H.264	4096x2160 @60fps	200Mbps	Main, High and High 10 Profile up to Level 6.0	FLV (.flv), MP4 (.mp4, .mov), 3GPP (.3gpp, .3gp), MPEG transport stream (.ts, .trp, .tp), ASF (.asf), WMV (.wmv), AVI (.avi), MKV (.mkv), WebM (.webm), OGM (.ogm), MPEG program stream (.dat, .vob, .mpg, .mpeg), H264 (.264)
AVS	1920x1080 @60fps	80Mbps 60Mbps	<ul style="list-style-type: none"> • Jizhun Profile @Level 6.0 • Guangbo Profile @Level 6.0 	3GPP (.3gpp, .3gp), MP4 (.mp4, .mov), MPEG transport stream (.ts, .trp, .tp), AVS (.avs)

Video Codec	Resolution	Bit Rate	Profile	Container
AVS2	4096x2304 @60fps	100Mbps	Main/Main-10bit Profile @Level 8.2.60	MPEG transport stream (.ts, .trp, .tp), AVS2 (.avs2)
VCI	1920x1080 @60fps	80Mbps	<ul style="list-style-type: none"> • Advanced Profile @Level 3 • Simple Profile • Main Profile 	MPEG transport stream (.ts, .trp, .tp), ASF (.asf), WMV (.wmv), AVI (.avi), WebM (.webm), 3GPP (.3gpp, .3gp), MP4 (.mp4, .mov), VCI (.vci)
Motion JPEG	1920x1080 @30fps	30Mbps	N/A	AVI (.avi), 3GPP (.3gpp, .3gp), MP4 (.mp4, .mov, .m4a), MKV (.mkv), WebM (.webm), FLV (.flv)
VP8	1920x1080 @60fps	60Mbps	N/A	MKV (.mkv), WebM (.webm), FLV (.flv), 3GPP (.3gpp, .3gp), MP4 (.mp4, .mov), AVI (.avi), OGM (.ogm)
RV30/RV40	1920x1080 @60fps	80Mbps	N/A	RM (.rm, .rmvb), MKV (.mkv), WebM (.webm)

InstaShare 2

Tap the shortcut  in the all apps menu to launch **InstaShare 2**. With this application, you can mirror the screen on your smartphone or tablet on your display to share with others or to annotate with touch-gestures.

 Before launching the application, make sure your display is properly connected to the Internet.

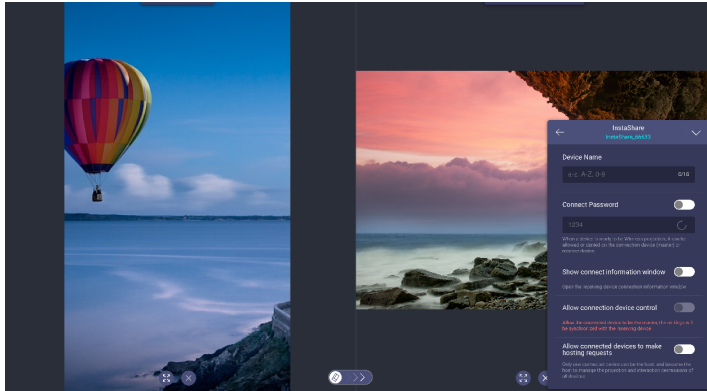
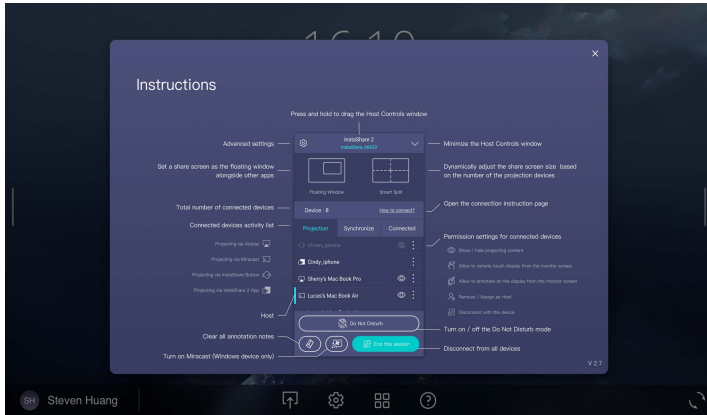

Product information

Specifications

Item		Specifications
		RM6503 / RM7503 / RM8603
Panel	Size	RM6503: 65" / RM7503: 75" / RM8603: 86"
	Light Source	DLED
	Aspect Ratio	16:9
	Resolution	3840 x 2160
	Pixel Pitch (mm)	RM6503: 0.372(H) x 0.372(V) RM7503: 0.4296(H) x 0.4296(V) RM8603: 0.4935(H) x 0.4935(V)
	Brightness with Glass (Typical)	RM6503: 350 (typical) RM7503: 400 (typical) RM8603: 400 (typical)
	Brightness without Glass (Typical)	RM6503: 400 (typical) RM7503: 450 (typical) RM8603: 450 (typical)
	Contrast Ratio (Typical)	1200:1
	Viewing Angle	178
Touch	Technology	IR
	Touch Method	Finger & Stylus
	System	Windows 7/8/10/XP/Linux/Mac/Android/Chrome OS
	Touch Point	up to 40pts touch for Windows; up to 32 pts touch for Android
	Minimum Object Size	2mm, pen tip is 3.2mm/1.1mm, supports 2 pens writing with 2 colors simultaneously
	Response Time	<10 ms
	Accuracy	±1 mm, 90% area

Item		Specifications
		RM6503 / RM7503 / RM8603
Connectors	HDMI IN	Rear: x 2, Front: x 1 (2.0)
	HDMI Output	x 1 (4K@60Hz with audio)
	DP IN	x 1
	VGA IN	x 1
	PC-Audio IN (3.5 mm audio-in)	x 1
	Mic IN	x 1
	SPDIF (Optical)	x 1
	Audio Output (3.5mm Earphone)	x 1
	USB 2.0 (Type A)	Rear I/O: x2
	USB 3.0 (Type A) (OPS/ External Follow)	Rear: x 2 (1.5A) Front: x 2 (1.5A) Wi-Fi dongle: x 1
Connectors	USB Touch Output (OPS/External pass through MIC/Camera/ USB)	Rear: x 2, Front: x 1 (USB 3.0)
	RS232	x1
	LAN (RJ45)	OPS: 10M/100M/1000M Android: 10M/100M LAN IN/Out x 2
	USB Type-C	x1 (Data/Power(65W)/Touch/DP ALT mode)
Android System	System Version	Android 9
	CPU	A73 x 4
	GPU	G52 MC 2
	RAM	8GB
	ROM	32GB
Video / Audio	Speaker Type	Built in speaker
	Output Power	16W x 2
Power	Power Requirements	AC 100V-240V, 50/60 Hz
	Standby Power	<0.5W
	Max Power Consumption (W)	RM6503: 334.6 W RM7503: 395.93 W RM8603: 488.2 W
	Wake Up	LAN/HDMI/VGA/DP
Others	Array Mic	x 6
	Light Sensors	Yes

Item		Specifications
		RM6503 / RM7503 / RM8603
Mechanical	Dimension (LxHxD)	RM6503: 1506 x 951 x 120mm RM7503: 1717 x 1065 x 121mm RM8603: 1962 x 1203 x 121mm
	Dimension (Package) LxWxH	RM6503: 1660 x 1160 x 220mm RM7503: 1900 x 1160 x 225mm RM8603: 2160 x 1340 x 250mm
	Net Weight	RM6503: 41.5±1.5kg RM7503: 53±1.5kg RM8603: 68.5±1.5kg
	Gross Weight	RM6503: 57.5±1.5kg RM7503: 72±1.5kg RM8603: 89.5±1.5kg
	Thickness of Machine and Wall Mount	Wall mount (VESA Mount)
	VESA for NUC	100 x 100 mm
	Wall-Hanging Screw Spec	M8*20L x 4
	VESA	RM6503: 600 x 400mm RM7503: 800 x 400mm RM8603: 800 x 600mm
Accessories	Power Cord By Region	3M x 1
	VGA Cable	3M x 1
	USB Cable (Type A-Type B)_USB 3.0	3M x 1
	Type C Cable	1.5 M x 1
	HDMI Cable	3M x 1
	Writing Pen	2 pcs
	Wall Mount	x 1
	Remote Control	1 pcs (BenQ customized)
Features	Image Setting	Yes
	Source/Volume Control	Yes
	HDMI Daisy Chain	Yes
	RS232 Control	Yes
	Sharpness Enhancement	Yes
	Proof of Image Retention	Yes
	Duo Windows	Yes (available by 2022Q2)
	HDMI-HDCP	Yes (2.0)
	DP-HDCP	Yes
10 Bit Color Processing	Yes	

Item		Specifications
		RM6503 / RM7503 / RM8603
Features (continued)	Video Wall OSD Setting	No
	Ambient Light Sensor	Yes
	Total Turn-on Time	Yes
	CEC Control	Yes
	RTC Function	Yes
	FW Update	Yes (USB, OTA)
	Freeze/Blank	Yes
	Front I/O	Yes
	Advanced Menu (Debug Menu)	Yes
	Double Lan Bridging	Yes
	Public USB Port Auto Switch	Yes
	Auto Detect Channel	Yes
	All channel can loop out by HDMI	Yes
	Button Lock	Yes
	Channel Lock	Yes (Sinage mode)
	Screen Lock	Yes
	Smart Sidebar	Yes
BenQ Customer API	Yes	
Environment	Operating Temperature	0 - 40°C
	Operating Humidity	10 - 90% (without condensation)
	Storage Temperature	-10 - 60°C
	Storage Humidity	10 - 80% (without condensation)
	Display Orientation	Landscape Only



- Specifications and functions are subject to change without notice.
- The product supports OPS. Refer to BenQ OPS models as below: TEY21-1015M8S4, TEY21-1015M8S5, TEY21-1017M8S4, TEY21-1017M8S5, TEY21B-1015M8S5, TEY21B-1017M8S5, TEY21Z-1015M8S5, TEY21Z-1017M8S5.
- The OPS should be equipped with fire-resistant enclosures.

Dimensions (RM6503)

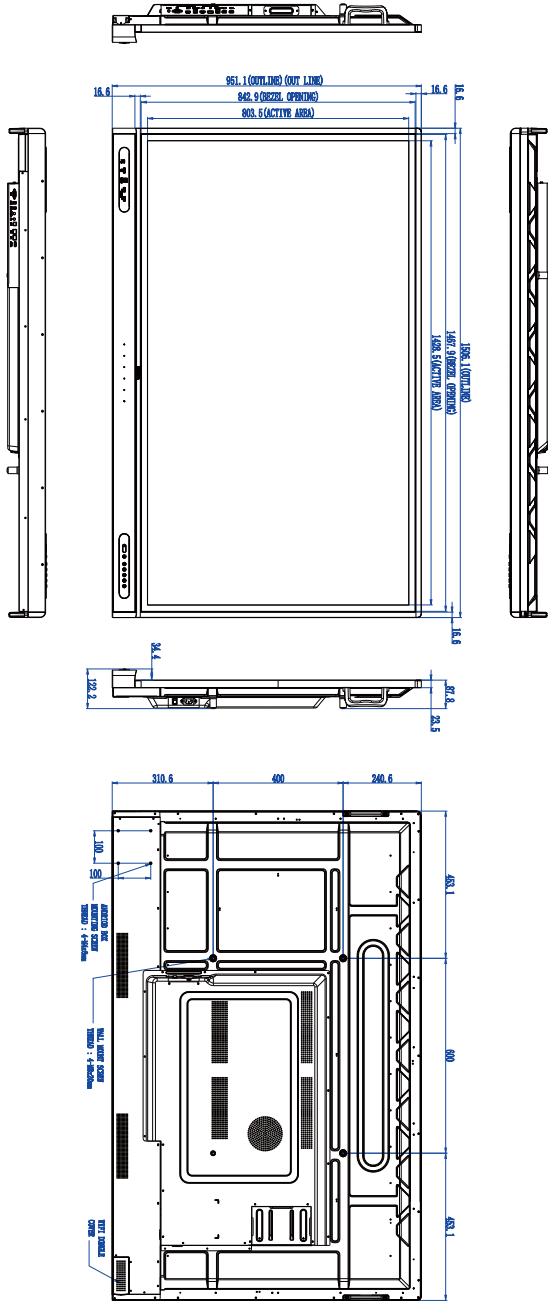

Unit: mm

Dimensions (RM7503)

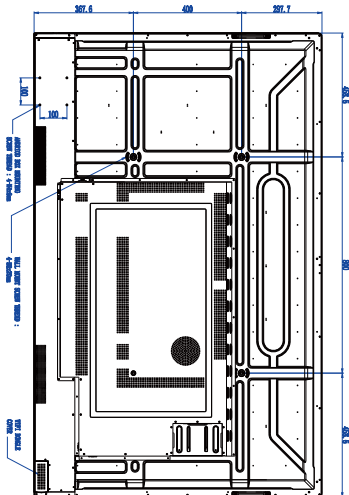
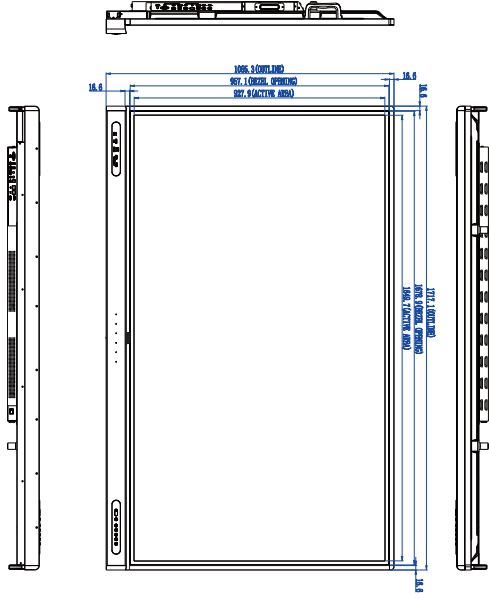

Unit: mm

Dimensions (RM8603)

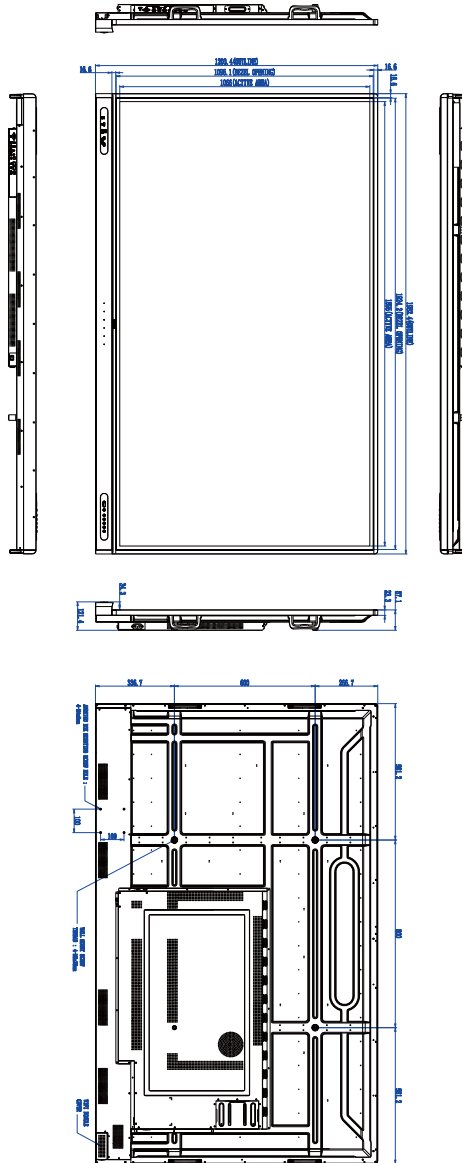

Unit: mm

Supported input signal resolution

Resolution	Input source		
	TYPE C	VGA	HDMI 2.0
640 x 480 @ 60Hz		○	
720 x 400 @ 85Hz		○	
800 x 600 @ 60Hz	○	○	○
1024 x 768 @ 60Hz	○	○	○
1280 x 768 @ 60Hz	○	○	○
1280 x 960 @ 60Hz	○	○	○
1280 x 1024 @ 60Hz	○	○	○
1366 x 768 @ 60Hz	○	○	○
1440 x 900 @ 60Hz	○	○	○
1680 x 1050 @ 60Hz	○	○	○
1920 x 1080 @ 60Hz	○	○	○
3840 x 2160 @ 24Hz			○
3840 x 2160 @ 25Hz			○
3840 x 2160 @ 30Hz			○
3840 x 2160 @ 50Hz			○
3840 x 2160 @ 60Hz	○		○
480i (60Hz)			○
480p (60Hz)	○		○
576i (50Hz)			○
576p (50Hz)	○		○
720p (50Hz)			○
720p (60Hz)	○		○
1080i (50Hz)			○
1080i (60Hz)			○
1080p (50Hz)			○
1080p (60Hz)	○		○



- : supported
- Vacant: not supported

Troubleshooting

Problem	Solution
No picture	Check the following: <ul style="list-style-type: none"> • Is the display turned on? Check the power indicator of the display. • Is the signal source device turned on? Turn on the device and try again. • Are there any loose cable connections? Make sure that all cables are connected firmly. • Have you chosen an unsupported output resolution on the computer? Refer to Supported input signal resolution on page 71 to select a supported resolution and try again. • Have you chosen an unsupported output resolution on the DVD or Blu-ray disc player? Refer to Supported input signal resolution on page 71 to select a supported resolution and try again.
No sound	Check the following: <ul style="list-style-type: none"> • Have you turned on the mute function on the display or the input source device? Turn off the mute function or increase the audio volume level and try again. • Are there any loose cable connections? Make sure that all cables are connected firmly.
The computer input image looks strange	<ul style="list-style-type: none"> • Have you chosen an unsupported output resolution on the computer? Refer to Supported input signal resolution on page 71 to select a supported resolution and try again. • Use the Auto function (VGA only) to let the display automatically optimize the display of computer image. • If the result of the Auto function is not satisfactory, use the Phase, H Position and V Position functions to manually adjust the image.
The control panel buttons do not work	Have you locked the control panel buttons? Unlock the buttons and try again.

The remote control does not work	<ul style="list-style-type: none"> • Have you locked the remote control function? Unlock the function and try again. • Check for incorrect battery orientation. • Check for dead batteries. • Check your distance and angle from the display. • Check whether remote control is properly being pointed at the display's remote control sensor window. • Check for any obstacle between the remote control and the remote control sensor window. • Check that the remote control sensor window is not under strong fluorescent lighting, or in direct sunlight. • Check for any devices (computer or personal digital assistant, PDA) nearby that transmit infrared signals which may cause interference to signal transmission between the remote control and the display. Turn off the infrared function of these devices.
Remote control failure	<ul style="list-style-type: none"> • Check whether there are other objects between remote control and television remote control receiving window, thus leading to failure of remote control. • Check whether the battery electrode in the remote control is correct. • Check whether remote control needs to replace battery.
Machine automatically shutdown	<ul style="list-style-type: none"> • Whether set sleep or not. • Check whether there is sudden power outage. • Check whether there is no signal automatic shutdown.
Signal out of range	<ul style="list-style-type: none"> • Check whether display is set correctly. • Check whether resolution is the best resolution. • Adjust line and field synchronization in menu.
Background has vertical lines or streaks	<ul style="list-style-type: none"> • Select automatic correction in menu. • Adjust clock and phase position in menu.
Image lack of color, color is incorrect	<ul style="list-style-type: none"> • Check whether VGA is not well connected or has quality problem. • Adjust chromaticity and brightness or contrast in menu.
Display format that is not supported.	<ul style="list-style-type: none"> • Select automatic correction in menu. • Adjust clock and phase position in menu.
Touch function invalid	<ul style="list-style-type: none"> • Check whether touch driver is installed and started. • Check whether the size of article touched is comparable with finger.
Touch positioning not correct	<ul style="list-style-type: none"> • Check whether driver is properly installed and make correction. • Check whether touch pen is facing the screen.

No picture and no sound	<ul style="list-style-type: none"> • Check whether the machine is started state. • Check whether signal wire is well plugged, whether INPUT is corresponding to it. • If in internal computer mode, check whether internal computer is started.
With horizontal or vertical stripes or image dithering	<ul style="list-style-type: none"> • Check whether signal wire is well connected. • Check whether other electronic equipment or power tools are placed around the machine.
No color, color is weak or image is weak	<ul style="list-style-type: none"> • Adjust chromaticity and brightness or contrast in menu. • Check whether signal wire is well connected.
With image but without sound	<ul style="list-style-type: none"> • Check whether mute button is pressed for mute. • Press VOL+/VOL- to adjust volume. • Check whether audio line is connected correctly.
Only one speaker has sound	<ul style="list-style-type: none"> • Adjust sound balance in menu. • Check whether computer sound control panel only sets up one sound channel. • Check whether audio line is connected correctly.
VGA output without sound	Check whether connect external device with headphone cable.

Accessibility Requirements for Rehabilitation Act of 1973, Section 508

BenQ's commitment to accessible products allows us to support government in making accessible technology choices. BenQ's displays are compliant with Section 508 guidelines by including the assistive features as below:

- BenQ's displays have colored "Power" indicators. Refer to the user manual for color definitions. While the display is in standby or sleep mode for wake-up function, it uses less than two watts of electricity.
- BenQ's displays have a variety of settings of pre-programmed flicker-free timing to make the screen shown on the display readily accessible. The default timing setting is automatically turned on every time the displays is powered up, and thus reduces the hassle of user intervention.
- BenQ's displays have options for brightness and contrast adjustments that text and images could be displayed differently to meet the demands of the visually impaired. Other similar adjustments are also available by using the On-Screen Display (OSD) controls on the products.
- BenQ's displays include user-selectable color controls, such as color temperature selections (IFP: 5500K, 9300K, 12000K, DS: 6500K, 9300K, 12000K), with a wide range of contrast levels.
- BenQ's multimedia displays usually have one or two speakers for audio performance which allow users (including hearing impaired) to interact with the computer systems connected. Speaker controls are typically located on the front-panel.
- Firmware of BenQ's displays contain unique product information that helps computer systems to identify BenQ products and activate their Plug-and-Play function when connected.
- All BenQ's displays are compatible with the PC99 standard. For example, connectors are colorcoded to help users easily connecting products to computer systems correctly.
- Some models of BenQ's displays contain additional USB ports for connection to more devices such as a special headphone to assist the hearing impaired.
- All BenQ displays come with user manuals, which are available on the BenQ's web site (www.BenQ.com). Other types of documents may be available upon requests.
- BenQ's customer service provides answers and assistance to all our customers through phone calls, facsimiles, e-mails, or web sites.