



Digital Projector
User Manual

Warranty and Copyright information

Limited warranty

BenQ warrants this product against any defects in material and workmanship, under normal usage and storage.

Proof of purchase date will be required with any warranty claim. In the event this product is found to be defective within the warranty period, BenQ's only obligation and your exclusive remedy shall be replacement of any defective parts (labor included). To obtain warranty service, immediately notify the dealer from which you purchased the product of any defects.

Important: The above warranty shall be void if the customer fails to operate the product in accordance with BenQ's written instructions, especially the ambient humidity must be in-between 10% and 90%, temperature in-between 0°C and 35°C, altitude lower than 4920 feet, and avoiding to operate the projector in a dusty environment. This warranty gives you specific legal rights, and you may have other rights which vary from country to country.

For other information, please visit www.BenQ.com.

Copyright

Copyright © 2022 by BenQ Corporation. All rights reserved. No part of this publication may be reproduced, transmitted, transcribed, stored in a retrieval system or translated into any language or computer language, in any form or by any means, electronic, mechanical, magnetic, optical, chemical, manual or otherwise, without the prior written permission of BenQ Corporation.

Disclaimer

BenQ Corporation makes no representations or warranties, either expressed or implied, with respect to the contents hereof and specifically disclaims any warranties, merchantability or fitness for any particular purpose. Further, BenQ Corporation reserves the right to revise this publication and to make changes from time to time in the contents hereof without obligation to notify any person of such revision or changes.

*DLP, Digital Micromirror Device and DMD are trademarks of Texas Instruments. Others are copyrights of their respective companies or organizations.

Patents

Please go to <http://patmarking.benq.com/> for the details on BenQ projector patent coverage.

Table of Contents

Warranty and Copyright information	2
Important safety instructions	4
Introduction	7
Shipping contents	7
Projector exterior view	8
Controls and functions.....	9
Positioning your projector	12
Choosing a location	12
Obtaining a preferred projected image size.....	13
Mounting the projector.....	16
Adjusting the projected image	17
Connection	19
Operation	21
Starting up the projector	21
Using the menus	22
Securing the projector	23
Switching input signal	24
Shutting down the projector	25
Menu operation	26
Menu System	26
Basic menu	31
Advanced menu	33
Maintenance	43
Care of the projector	43
Light source information	43
Troubleshooting	46
Specifications	47
Projector specifications	47
Dimensions	48
Timing chart.....	49

Important safety instructions

Your projector is designed and tested to meet the latest standards for safety of information technology equipment. However, to ensure safe use of this product, it is important that you follow the instructions mentioned in this manual and marked on the product.

1. **Please read this manual before you operate your projector.** Save it for future reference.



2. **Do not look straight at the projector lens during operation.** The intense light beam may damage your eyes.



3. **Refer servicing to qualified service personnel.**



4. **Always open the lens shutter (if any) or remove the lens cap (if any) when the projector light source is on.**

5. The light source becomes extremely hot during operation.

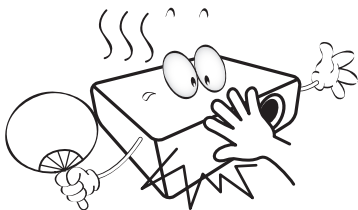

6. In some countries, the line voltage is NOT stable. This projector is designed to operate safely within a mains voltage between 100 to 240 volts AC, but could fail if power cuts or surges of ± 10 volts occur. **In areas where the mains voltage may fluctuate or cut out, it is recommended that you connect your projector through a power stabilizer, surge protector or uninterruptible power supply (UPS).**

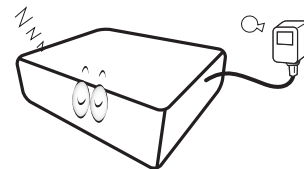

7. Do not block the projection lens with any objects when the projector is under operation as this could cause the objects to become heated and deformed or even cause a fire. To temporarily turn off the light source, use the blank function.

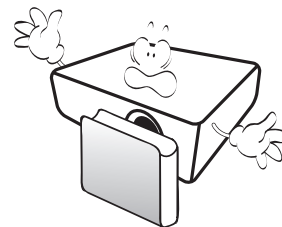

8. Do not operate light sources beyond the rated light source life.

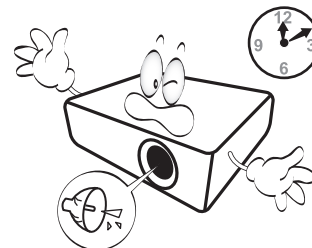

9. Do not place this product on an unstable cart, stand, or table. The product may fall, sustaining serious damage.

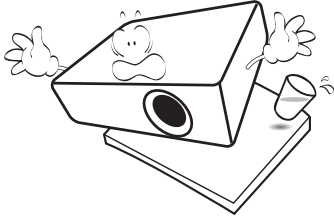

10. Do not attempt to disassemble this projector. There are dangerous high voltages inside which may cause death if you should come into contact with live parts.

Under no circumstances should you ever undo or remove any other covers. Refer servicing only to suitably qualified professional service personnel.

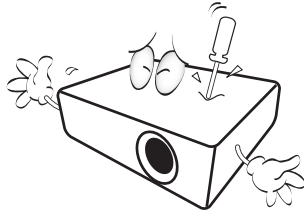

11. Do not block the ventilation holes.

- Do not place this projector on a blanket, bedding or any other soft surface.
- Do not cover this projector with a cloth or any other item.
- Do not place inflammables near the projector.

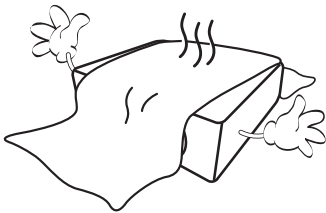

If the ventilation holes are seriously obstructed, overheating inside the projector may result in a fire.

12. Always place the projector on a level, horizontal surface during operation.

- Do not use if tilted at an angle of more than 10 degrees left to right, nor at angle of more than 15 degrees front to back. Using the projector when it is not fully horizontal may cause a malfunction of, or damage to, the light source.

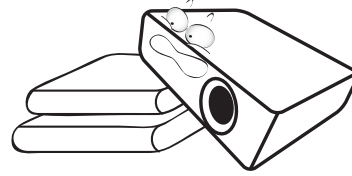

13. Do not stand the projector on end vertically. Doing so may cause the projector to fall over, causing injury or resulting in damage to the projector.

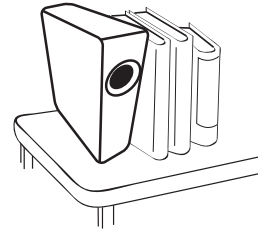

14. Do not step on the projector or place any objects upon it. Besides probable physical damage to the projector, doing so may result in accidents and possible injury.

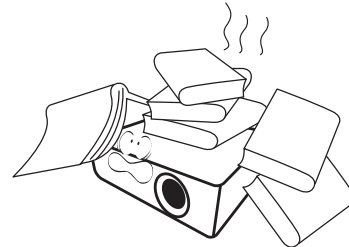

15. When the projector is under operation, you may sense some heated air and odor from its ventilation grill. It is a normal phenomenon and not a product defect.

16. Do not place liquids near or on the projector. Liquids spilled into the projector may cause it to fail. If the projector does become wet, disconnect it from the power supply's power outlet and call BenQ to have the projector serviced.

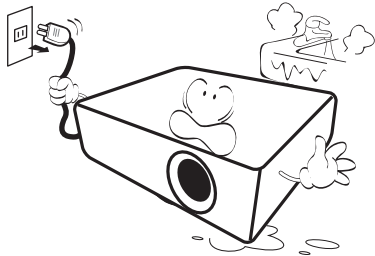

17. This product is capable of displaying inverted images for ceiling/wall mount installation.

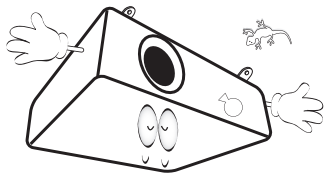

18. This apparatus must be earthed.

19. Do not place this projector in any of the following environments.

- Space that is poorly ventilated or confined. Allow at least 50 cm clearance from walls and free flow of air around the projector.
- Locations where temperatures may become excessively high, such as the inside of a car with all windows rolled up.
- Locations where excessive humidity, dust, or cigarette smoke may contaminate optical components, shorten the projector's life span and darken the image.

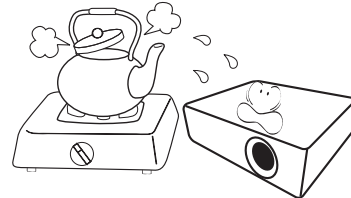

- Locations near fire alarms
- Locations with an ambient temperature above 40°C / 104°F
- Locations where the altitudes are higher than 3000 m (10000 feet).

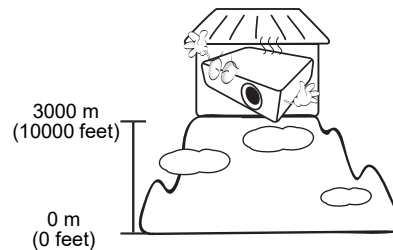

Risk Group 2

1. According to the classification of photobiological safety of light sources and light source systems, this product is Risk Group 2, IEC 62471-5:2015.
2. Possibly hazardous optical radiation emitted from this product.
3. Do not stare at operating light source. May be harmful to the eyes.
4. As with any bright source, do not stare into the direct beam.



! To avoid damaging the DLP chips, never aim a high-power laser beam into the projection lens.

Introduction

Shipping contents

Carefully unpack and verify that you have all of the items shown below. If any of these items are missing, please contact your place of purchase.

Standard accessories

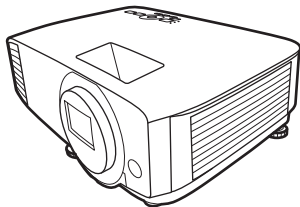

Projector

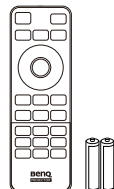

Remote control with batteries

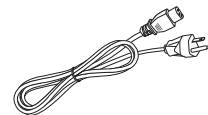

Power cord

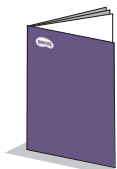

Quick start guide



Warranty card*

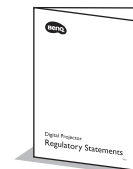

Regulatory statements



- The supplied accessories will be suitable for your region, and may differ from those illustrated.
- *The warranty card is only supplied in some specific regions. Please consult your dealer for detailed information.

Replacing the remote control batteries

1. Press and open the battery cover, as illustrated.
2. Remove the old batteries (if applicable) and install two AAA batteries. Make sure that the positive and negative ends are positioned correctly, as illustrated.
3. Replace the battery cover until it clicks into place.

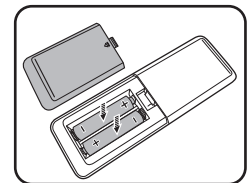
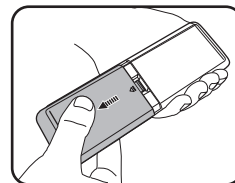

- Avoid leaving the remote control and batteries in an excessive heat or humid environment like the kitchen, bathroom, sauna, sunroom or in a closed car.
- Replace only with the same or equivalent type recommended by the battery manufacturer.
- Dispose of the used batteries according to the manufacturer's instructions and local environment regulations for your region.
- Never throw the batteries into a fire. There may be danger of an explosion.
- If the batteries are dead or if you will not be using the remote control for an extended period of time, remove the batteries to avoid damage to the remote control from possible battery leakage.

Projector exterior view

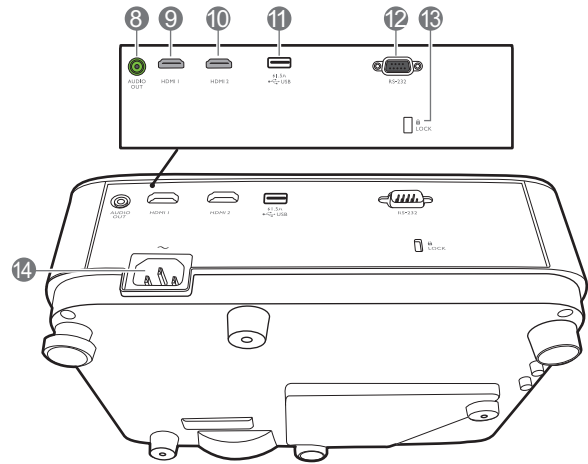
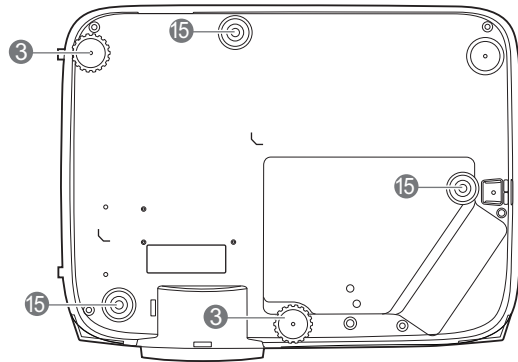
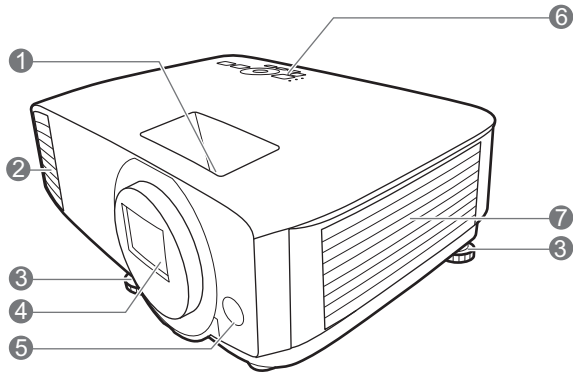

- 1. Focus ring and Zoom ring
- 2. Vent (air exhaust)
- 3. Adjuster feet
- 4. Projection lens
- 5. IR remote sensor
- 6. External control panel
(See [Controls and functions on page 9.](#))
- 7. Vent (air inlet)

- 8. Audio output jack
- 9. HDMI 1 input port
- 10. HDMI 2 input port
- 11. USB Type A port with power charging
- 12. RS-232 control port
- 13. Kensington anti-theft lock slot
- 14. AC power jack
- 15. Wall mount holes

Controls and functions

Projector & Remote control



All the key presses described in this document are available on the remote control or projector.

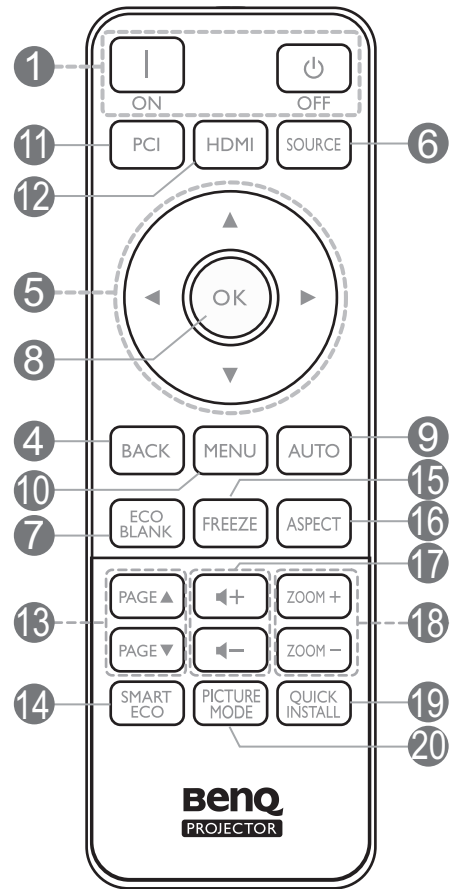
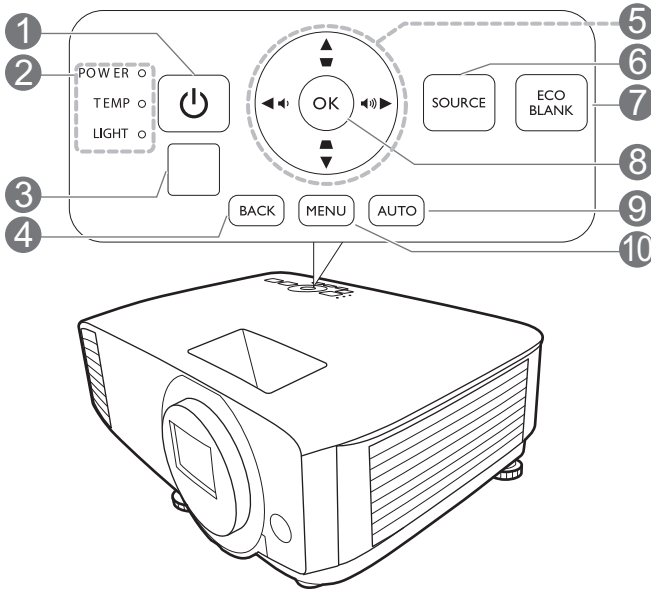

1. **POWER**

Toggles the projector between standby mode and on.



Toggles the projector between standby mode and on.

2. **POWER indicator light/TEMPERature warning light/LIGHT indicator light** (See [Indicators on page 45.](#))

3. IR remote sensor

4. **BACK**

Goes back to previous OSD menu, exits and saves menu settings.

5. Arrow keys (, , ,)

When the On-Screen Display (OSD) menu is activated, these keys are used as directional arrows to select the desired menu items and to make adjustments.

Keystone keys (,)

Displays the keystone correction page.

Volume keys (,)

Decreases or increase the projector volume.

6. **SOURCE**

Displays the source selection bar.

7. **ECO BLANK**

Used to hide the screen picture.



Do not block the projection lens from projecting as this could cause the blocking object to become heated and deformed or even cause a fire.

8. **OK**

Confirms the selected On-Screen Display (OSD) menu item.

9. **AUTO**

Automatically determines the best picture timings for the displayed image when PC signal (analog RGB) is selected.

10. **MENU**

Turns on the On-Screen Display (OSD) menu.

11. Source selection button: **PC I**

No function.

12. Source selection button: **HDMI**

Selects **HDMI** input source for display.

13. **PAGE▲/PAGE▼**

Operate your display software program (on a connected PC) which responds to page up/down commands (like Microsoft PowerPoint).

14. **SMART ECO**

Displays the **Light Mode** menu for selecting a suitable light source operating mode.

15. **FREEZE**

Freezes the projected image.

16. **ASPECT**

Selects the display aspect ratio.

17. Volume keys ◀- / ▶+

Decreases or increase the projector volume.

18. **ZOOM+/ZOOM-**

Magnifies or reduces the projected picture size.

19. **QUICK INSTALL**

Quickly selects several functions to adjust the projected image and displays the test pattern.

20. **Picture Mode**

Displays the **Picture Mode** menu for selecting a picture mode.

Remote control effective range

The remote control must be held at an angle within 30 degrees perpendicular to the projector's IR remote control sensor(s) to function correctly. The distance between the remote control and the sensor(s) should not exceed 8 meters (~ 26 feet).

Make sure that there are no obstacles between the remote control and the IR sensor(s) on the projector that might obstruct the infra-red beam.

- Operating the projector from the front

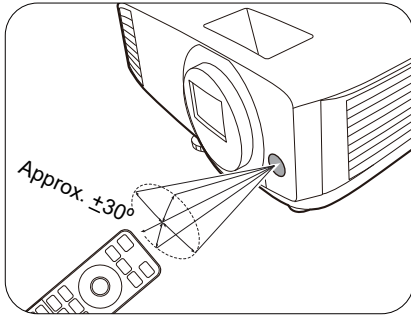

- Operating the projector from the top

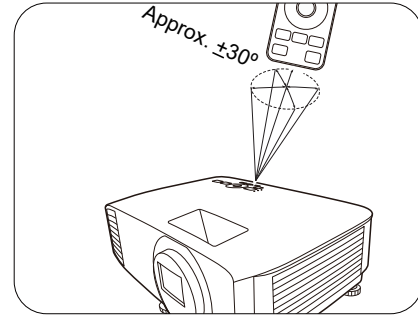

Positioning your projector

Choosing a location

Before choosing an installation location for your projector, take the following factors into consideration:

- Size and position of your screen
- Electrical outlet location
- Location and distance between the projector and the rest of your equipment

You can install your projector in the following ways.

1. Front Table

Select this location with the projector placed on the table in front of the screen. This is the most common way to position the projector for quick setup and portability.

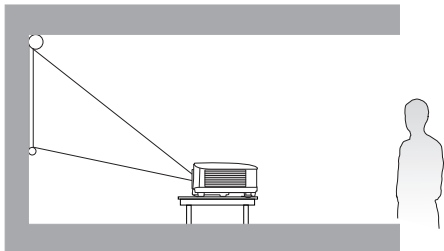

2. Rear Table

Select this location with the projector placed on the table behind the screen. Note that a special rear projection screen is required.

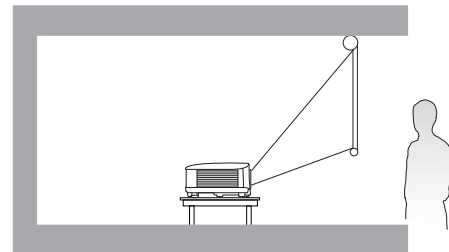

3. Front Ceiling

Select this location with the projector suspended upside-down in front of the screen. Purchase the BenQ Projector Ceiling/Wall Mount Kit from your dealer to mount your projector.

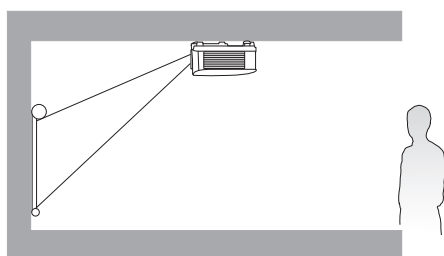

4. Rear Ceiling

Select this location with the projector suspended upside-down from behind the screen. Note that a special rear projection screen and the BenQ Projector Ceiling/Wall Mount Kit are required for this installation location.

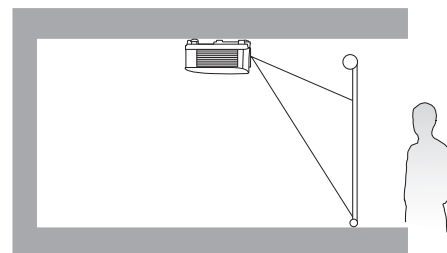

After turning on the projector, go to **Advanced Menu - Settings > Projector Installation** and press ◀/▶ to select a setting.

You can also use **QUICK INSTALL** on the remote control to access this menu.

Obtaining a preferred projected image size

The distance from the projector lens to the screen, the zoom setting (if available), and the video format each factors in the projected image size.

Projection dimensions

- The screen aspect ratio is 16:10 and the projected picture is in a 16:10 aspect ratio

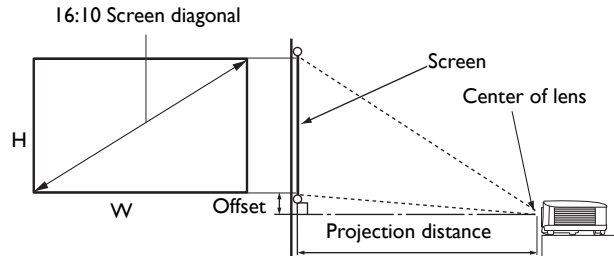

LW500

Screen size				Projection distance (mm)			Offset (mm)
Diagonal		H (mm)	W (mm)	Min distance (with max zoom)	Average	Max distance (with min zoom)	
Inch	mm						
30	762	404	646	1002	1050	1098	0
40	1016	538	862	1335	1400	1465	0
50	1270	673	1077	1669	1750	1831	0
60	1524	808	1292	2003	2100	2197	0
70	1778	942	1508	2337	2450	2563	0
80	2032	1077	1723	2671	2800	2929	0
90	2286	1212	1939	3005	3150	3295	0
100	2540	1346	2154	3339	3500	3662	0
110	2794	1481	2369	3672	3850	4028	0
120	3048	1615	2585	4006	4200	4394	0
130	3302	1750	2800	4340	4550	4760	0
140	3556	1885	3015	4674	4900	5126	0
150	3810	2019	3231	5008	5250	5492	0
160	4064	2154	3446	5342	5600	5859	0
170	4318	2289	3662	5676	5950	6225	0
180	4572	2423	3877	6009	6300	6591	0
190	4826	2558	4092	6343	6650	6957	0
200	5080	2692	4308	6677	7000	7323	0

For example, if you are using a 120-inch screen, the recommended projection distance is 4200 mm.

If your measured projection distance is 5200 mm, the closest match in the "Projection distance (mm)" column is 5250 mm. Looking across this row shows that a 150" (about 3.8 m) screen is required.

LW500ST

Screen size				Projection distance (mm)			Offset (mm)
Diagonal		H (mm)	W (mm)	Min distance (with max zoom)	Average	Max distance (with min zoom)	
Inch	mm						
30	762	404	646	465	514	562	0
40	1016	538	862	620	685	750	0
50	1270	673	1077	775	856	937	0
60	1524	808	1292	930	1027	1124	0
70	1778	942	1508	1086	1199	1312	0
80	2032	1077	1723	1241	1370	1499	0
90	2286	1212	1939	1396	1541	1687	0
100	2540	1346	2154	1551	1712	1874	0
110	2794	1481	2369	1706	1884	2061	0
120	3048	1615	2585	1861	2055	2249	0
130	3302	1750	2800	2016	2226	2436	0
140	3556	1885	3015	2171	2397	2623	0
150	3810	2019	3231	2326	2569	2811	0
160	4064	2154	3446	2481	2740	2998	0
170	4318	2289	3662	2636	2911	3186	0
180	4572	2423	3877	2791	3082	3373	0
190	4826	2558	4092	2947	3253	3560	0
200	5080	2692	4308	3102	3425	3748	0

For example, if you are using a 120-inch screen, the recommended projection distance is 2055 mm.

If your measured projection distance is 1500 mm, the closest match in the "Projection distance (mm)" column is 1541 mm. Looking across this row shows that a 90" (about 2.3 m) screen is required.



To optimize your projection quality, we suggest doing the projection by referring to the values listed in the non-gray rows.



All measurements are approximate and may vary from the actual sizes.

BenQ recommends that if you intend to permanently install the projector, you should physically test the projection size and distance using the actual projector in situ before you permanently install it, so as to make allowance for this projector's optical characteristics. This will help you determine the exact mounting position so that it best suits your installation location.

LH500

- The screen aspect ratio is 16:9 and the projected picture is in a 16:9 aspect ratio

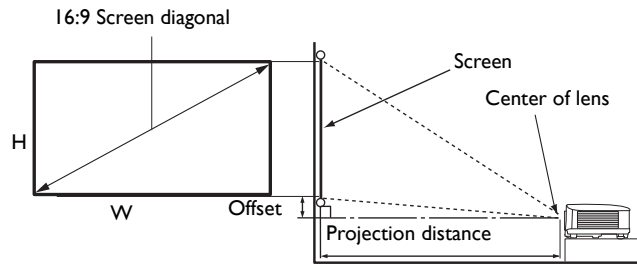

Screen size				Projection distance (mm)			Offset (mm)
Diagonal		H (mm)	W (mm)	Min distance (with max zoom)	Average	Max distance (with min zoom)	
Inch	mm						
30	762	374	664	990	1039	1089	11
40	1016	498	886	1319	1386	1452	15
50	1270	623	1107	1649	1732	1815	19
60	1524	747	1328	1979	2079	2178	22
70	1778	872	1550	2309	2425	2541	26
80	2032	996	1771	2639	2772	2905	30
90	2286	1121	1992	2969	3118	3268	34
100	2540	1245	2214	3299	3465	3631	37
110	2794	1370	2435	3628	3811	3994	41
120	3048	1494	2657	3958	4158	4357	45
130	3302	1619	2878	4288	4504	4720	49
140	3556	1743	3099	4618	4850	5083	52
150	3810	1868	3321	4948	5197	5446	56
160	4064	1992	3542	5278	5543	5809	60
170	4318	2117	3763	5608	5890	6172	64
180	4572	2241	3985	5937	6236	6535	67
190	4826	2366	4206	6267	6583	6898	71
200	5080	2491	4428	6597	6929	7261	75

For example, if you are using a 120-inch screen, the recommended projection distance is 4158 mm.

If your measured projection distance is 3000 mm, the closest match in the "Projection distance (mm)" column is 3118 mm. Looking across this row shows that a 90" (about 2.3 m) screen is required.



To optimize your projection quality, we suggest doing the projection by referring to the values listed in the non-gray rows.



All measurements are approximate and may vary from the actual sizes.

BenQ recommends that if you intend to permanently install the projector, you should physically test the projection size and distance using the actual projector in situ before you permanently install it, so as to make allowance for this projector's optical characteristics. This will help you determine the exact mounting position so that it best suits your installation location.

Mounting the projector

If you intend to mount your projector, we strongly recommend that you use a proper fitting BenQ projector mounting kit and that you ensure it is securely and safely installed.

If you use a non-BenQ brand projector mounting kit, there is a safety risk that the projector may fall down due to an improper attachment through the use of the wrong gauge or length screws.

Before mounting the projector

- Purchase a BenQ projector mounting kit from the place you purchased your BenQ projector.
- BenQ recommends that you also purchase a separate Kensington lock compatible security cable and attach it securely to both the Kensington lock slot on the projector and the base of the mounting bracket. This will perform the secondary role of restraining the projector should its attachment to the mounting bracket become loose.
- Ask your dealer to install the projector for you. Installing the projector on your own may cause it to fall and result in injury.
- Take necessary procedures to prevent the projector from falling off such as during an earthquake.
- The warranty doesn't cover any product damage caused by mounting the projector with a non-BenQ brand projector mounting kit.
- Consider the surrounding temperature where the projector is ceiling/wall mounted. If a heater is used, the temperature around the ceiling/wall may be higher than expected.
- Read the user manual for the mounting kit about the range of torque. Tightening with torque exceeding the recommended range may cause damage to the projector and subsequently falling off.
- Make sure the power outlet is at an accessible height so that you can easily shut down the projector.

Ceiling/Wall mount installation diagram

Ceiling/Wall mount screw: M4
(Max L = 25 mm; Min L = 20 mm)

LW500/LH500

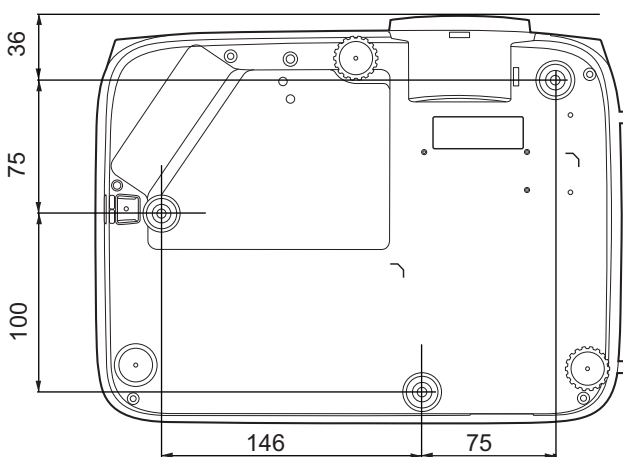

LW500ST

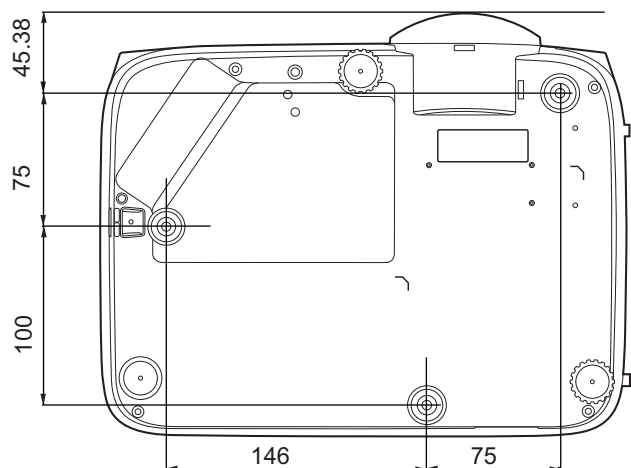

Unit: mm

Adjusting the projected image

Adjusting the projection angle

If the projector is not placed on a flat surface or the screen and the projector are not perpendicular to each other, the projected image becomes trapezoidal. You can screw the adjuster feet to fine-tune the horizontal angle.

To retract the feet, screw the adjuster feet in a reverse direction.

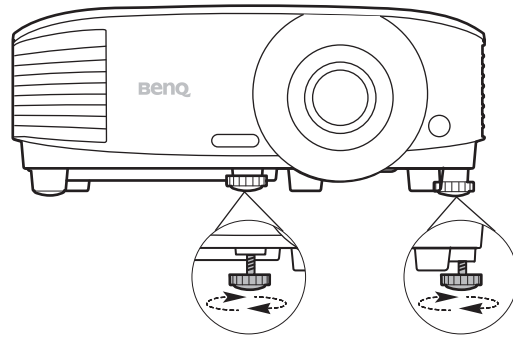

Do not look into the lens while the light source is on. The strong light from the light source may cause damage to your eyes.

Fine-tuning the image size and clarity

Adjust the projected image to the size that you need using the zoom ring.

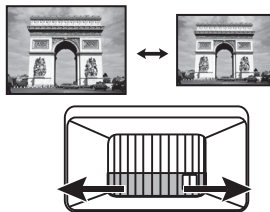

Sharpen the image by rotating the focus ring.

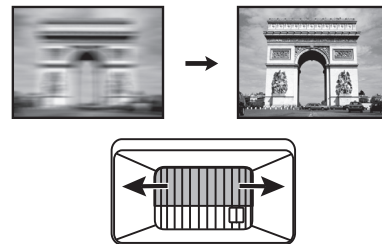

Correcting keystone

Keystoning refers to the situation where the projected image becomes a trapezoid due to angled projection.

To correct this, besides adjusting the height of the projector, if you want the projector to automatically correct image keystoning, be sure the **Auto Vertical Keystone** function in the **Advanced Menu - Display** menu is **On**.

Or you will need to manually correct it following these steps.

1. Do one of the following steps to display the keystone correction page.
 - Press **▲** / **▼** on the projector or remote control.
 - Press **QUICK INSTALL** on the remote control. Press **▼** to highlight **Keystone** or **2D Keystone** and press **OK**.
 - Go to **Advanced Menu - Display > Keystone** or **2D Keystone** and press **OK**.

2. After the **Keystone** or **2D Keystone** correction page displays. To correct keystone at the top of the image, use ▼. To correct keystone at the bottom of the image, use ▲. To correct keystone at the right side of the image, use ◀. To correct keystone at the left side of the image, use ▶.

(LW500/LH500: Keystone)



(LW500ST: 2D Keystone)

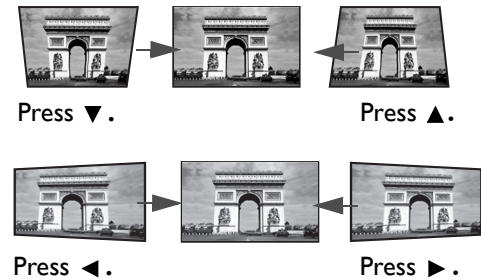

Adjusting Corner Fit (LW500ST)

You can manually adjust four corners of the image by setting the horizontal and vertical values.

1. Do one of the following steps to display the keystone correction page.
 - Press **QUICK INSTALL** on the remote control. Press ▼ to highlight **Corner Fit** and press **OK**.
 - Go to **Advanced** menu - **Display** > **Corner Fit** and press **OK**.
2. Press ▲/▼/◀/▶ to select one corner and press **OK**.
3. Press ▲/▼ to adjust vertical values.
4. Press ◀/▶ to adjust horizontal values.

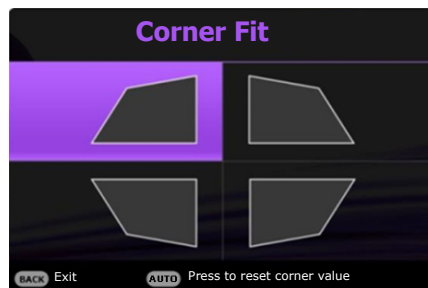

Connection

When connecting a signal source to the projector, be sure to:

1. Turn all equipment off before making any connections.
2. Use the correct signal cables for each source.
3. Ensure the cables are firmly inserted.

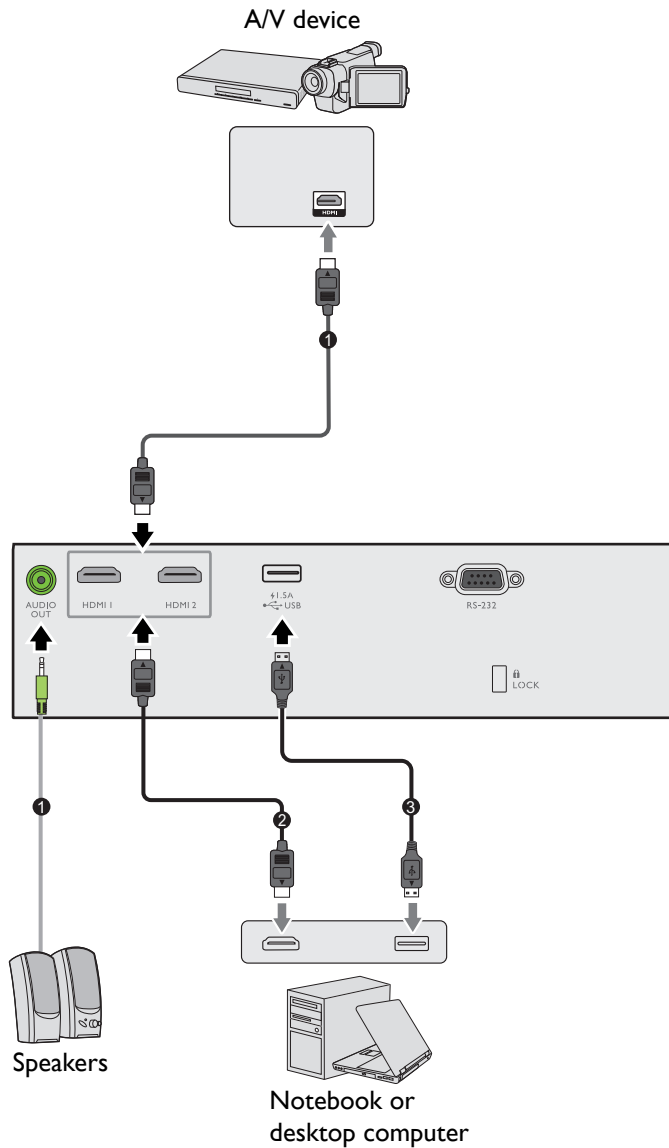

1	Audio cable
2	HDMI cable
3	USB cable



- In the connections above, some cables may not be included with the projector (see [Shipping contents on page 7](#)). They are commercially available from electronics stores.
- The connection illustrations are for reference only. The rear connecting jacks available on the projector vary with each projector model.
- Many notebooks do not turn on their external video ports when connected to a projector. Usually a key combo like FN + function key with a monitor symbol turns the external display on/off. Press FN and the labeled function key simultaneously. Refer to your notebook's documentation to find your notebook's key combination.
- If the selected video image is not displayed after the projector is turned on and the correct video source has been selected, check that the video source device is turned on and operating correctly. Also check that the signal cables have been connected correctly.

Connecting audio

The projector has built-in mono speaker(s) which are designed to provide basic audio functionality accompanying data presentations for business purposes only. They are not designed for, nor intended for stereo audio reproduction use as might be expected in home theater or home cinema applications. Any stereo audio input (if provided), is mixed into a common mono audio output through the projector speaker(s).



The built-in speaker(s) will be muted when the **AUDIO OUT** jack is connected.



- The projector is only capable of playing mixed mono audio, even if a stereo audio input is connected.
- If the selected video image is not displayed after the projector is turned on and the correct video source has been selected, check that the video source device is turned on and operating correctly. Also check that the signal cables have been connected correctly.

Operation

Starting up the projector

1. Plug the power cord. Turn on the power outlet switch (where fitted). The power indicator on the projector lights orange after power has been applied.
2. Press  on the projector or  on the remote control to start the projector. The power indicator flashes green and stays green when the projector is on.

The start up procedure takes about 10 seconds. In the later stage of start up, a startup logo is projected.

(If necessary) Rotate the focus ring to adjust the image clearness.

3. If the projector is activated for the first time, select your OSD language following the on-screen instructions.
4. If you are prompted for a password, press the arrow keys to enter a 6-digit password. See [Utilizing the password function on page 23](#).
5. Switch all of the connected equipment on.
6. The projector will search for input signals. The current input signal being scanned appears. If the projector does not detect a valid signal, the message “No Signal” will continue displaying until an input signal is found.

You can also press **SOURCE** to select your desired input signal. See [Switching input signal on page 24](#).

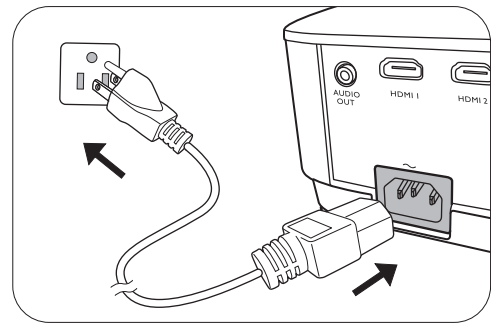

- Please use the original accessories (e.g. power cord) to avoid possible dangers such as electric shock and fire.
- If the projector is still hot from previous activity, it will run the cooling fan for approximately 90 seconds before energizing the light source.



- The Setup Wizard screenshots are for reference only and may differ from the actual design.
- If the frequency/resolution of the input signal exceeds the projector's operating range, you will see the message “Out of Range” displayed on the background screen. Please change to an input signal which is compatible with the projector's resolution or set the input signal to a lower setting. See [Timing chart on page 49](#).
- If no signal is detected for 3 minutes, the projector automatically enters saving mode.

Using the menus

The projector is equipped with 2 types of On-Screen Display (OSD) menus for making various adjustments and settings.

To access the OSD menu, press **MENU** on the projector or remote control.

- Use the arrow keys (▲/▼/◀/▶) on the projector or remote control to move through the menu items.
- Use **OK** on the projector or remote control to confirm the selected menu item.

The first time you use the projector (after finishing the initial setup), press **MENU**, and the **Basic** OSD menu will be displayed.

If you intend to switch from the **Basic** OSD menu to the **Advanced** OSD menu:

1. Go to **Menu Type** and press **OK**.
2. Use ▲/▼ to select **Advanced** and press **OK**. Your projector will switch to the **Advanced** OSD menu.

Likewise, when you wish to switch from the **Advanced** OSD menu to the **Basic** OSD menu, follow the instructions below:

1. Go to **System > Menu Settings > Menu Type** and press **OK**.
2. Use ▲/▼ to select **Basic** and press **OK**. Your projector will switch to the **Basic** OSD menu.

Overview of the **Basic** OSD menu.

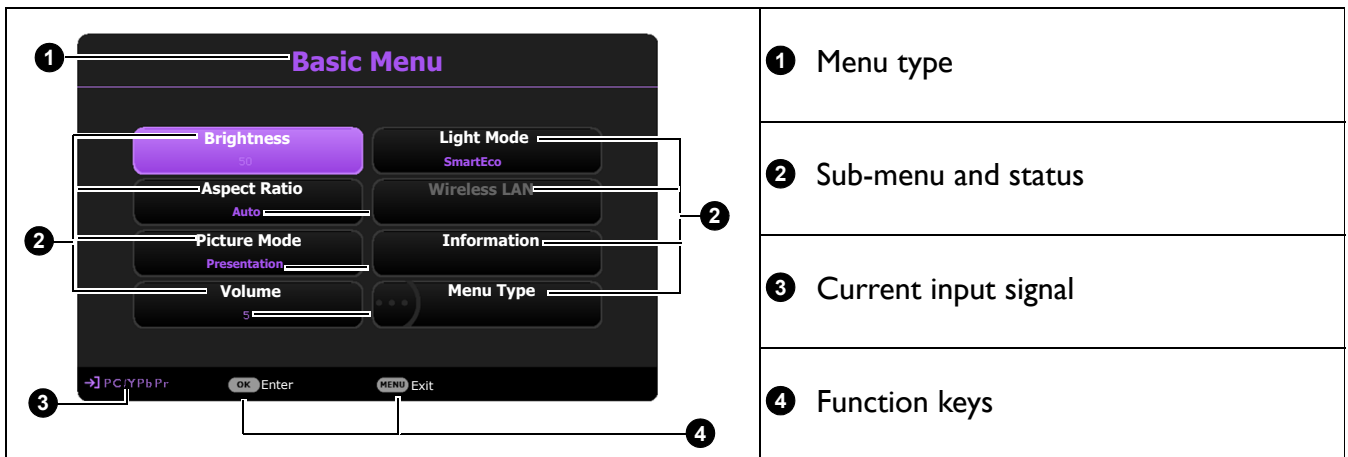

Overview of the **Advanced** OSD menu.

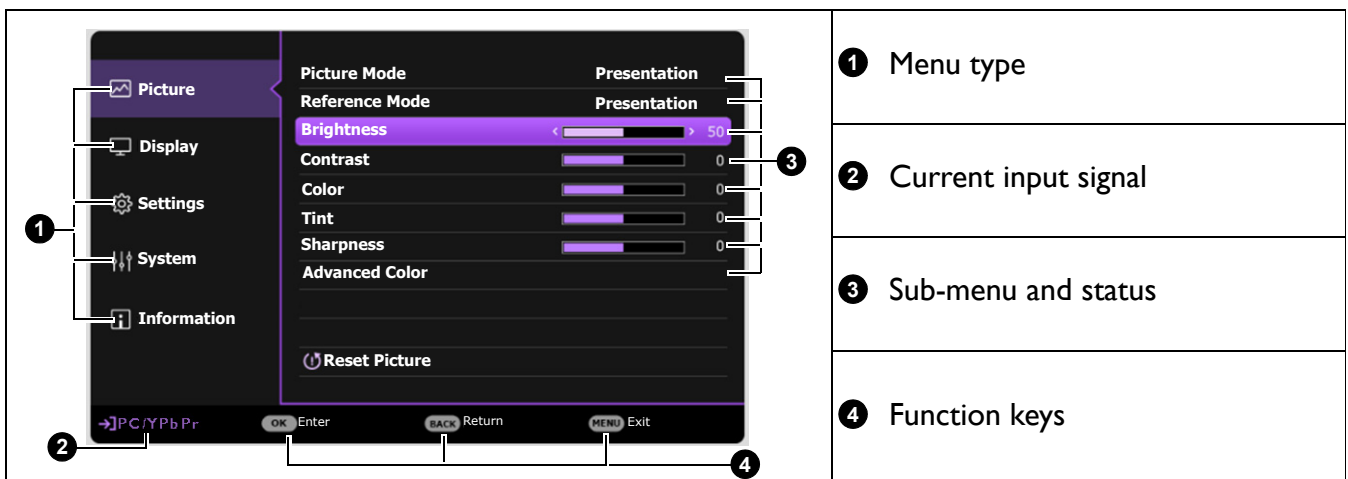

The OSD screenshots below are for reference only, and may differ from the actual design.

Securing the projector

Using a security cable lock

The projector has to be installed in a safe place to prevent theft. Otherwise, purchase a lock, such as the Kensington lock, to secure the projector. You can locate a Kensington lock slot on the rear side of the projector. See item 15 on [page 8](#).

A Kensington security cable lock is usually a combination of key(s) and the lock. Refer to the lock's documentation for finding out how to use it.

Utilizing the password function

Setting a password

1. Go to **Advanced Menu - Settings > Security Settings**. Press **OK**. The **Security Settings** page appears.
2. Highlight **Change Password** and press **OK**.
3. The four arrow keys (**▲**, **▶**, **▼**, **◀**) respectively represent 4 digits (1, 2, 3, 4). According to the password you desire to set, press the arrow keys to enter six digits for the password.
4. Confirm the new password by re-entering the new password.
Once the password is set, the OSD menu returns to the **Security Settings** page.
5. To activate the **Power On Lock** function, press **▲/▼** to highlight **Power On Lock** and press **◀/▶** to select **On**. Input the password again.

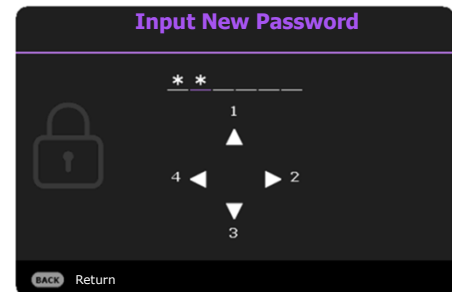

- The digits being input will display as asterisks on-screen. Make a note of your selected password and keep it in a safe place in advance or right after the password is entered so that it is available to you should you ever forget it.
- Once a password has been set and the power on lock is activated, the projector cannot be used unless the correct password is entered every time the projector is started.

If you forget the password

If you enter the wrong password, the password error message will appear, and the **Input Password** message follows. If you absolutely do not remember the password, you can use the password recall procedure. See [Entering the password recall procedure on page 24](#).

If you enter an incorrect password 5 times in succession, the projector will automatically shut down in a short time.

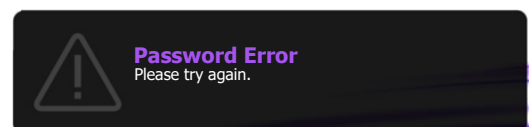

Entering the password recall procedure

1. Press and hold **AUTO** for 3 seconds. The projector will display a coded number on the screen.
2. Write down the number and turn off your projector.
3. Seek help from the local BenQ service center to decode the number. You may be required to provide proof of purchase documentation to verify that you are an authorized user of the projector.

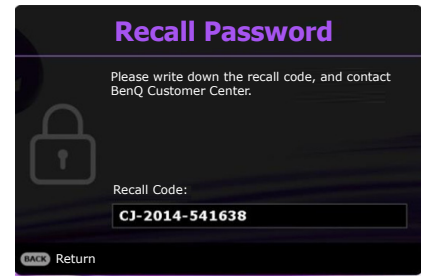

Changing the password

1. Go to **Advanced Menu - Settings > Security Settings > Change Password**.
2. Press **OK**. The message “**Input Password**” appears.
3. Enter the old password.
 - If the password is correct, another message “**Input New Password**” appears.
 - If the password is incorrect, the password error message will appear, and the message “**Input Password**” appears for your retry. You can press **BACK** to cancel the change or try another password.
4. Enter a new password.
5. Confirm the new password by re-entering the new password.

Disabling the password function

To disable password protection, go to **Advanced Menu - Settings > Security Settings > Power On Lock** and press **◀/▶** to select **Off**. The message “**Input Password**” appears. Enter the current password.

- If the password is correct, the OSD menu returns to the **Security Settings** page. You will not have to enter the password next time turning on the projector.
- If the password is incorrect, the password error message will appear, and the message “**Input Password**” appears for your retry. You can press **BACK** to cancel the change or try another password.



Though the password function is disabled, you need to keep the old password in hand should you ever need to re-activate the password function by entering the old password.

Switching input signal

The projector can be connected to multiple devices at the same time. However, it can only display one full screen at a time. When starting up, the projector automatically searches for the available signals.

Be sure the **Advanced Menu - Settings > Auto Source Search** menu is **On** if you want the projector to automatically search for the signals.

To select the source:

1. Press **SOURCE**. A source selection bar appears.
2. Press **▲/▼** until your desired signal is selected and press **OK**.





Once detected, the selected source information will appear at the corner of the screen for seconds. If there is multiple equipment connected to the projector, repeat steps 1-2 to search for another signal.





- The brightness level of the projected image will change accordingly when you switch between different input signals.
- For best display picture results, you should select and use an input signal which outputs at the projector's native resolution. Any other resolutions will be scaled by the projector depending upon the "aspect ratio" setting, which may cause some image distortion or loss of picture clarity. See [Aspect Ratio on page 31](#).

Shutting down the projector

1. Press  on the projector or  on the remote control and a confirmation message will appear prompting you. If you don't respond in a few seconds, the message will disappear.
2. Press  or  a second time. The power indicator flashes orange, the projection light source shuts down, and the fans will continue to run for approximately 2 seconds to cool down the projector.
3. Once the cooling process finishes, the power indicator becomes a steady orange and fans stop. Disconnect the power cord from the power outlet.

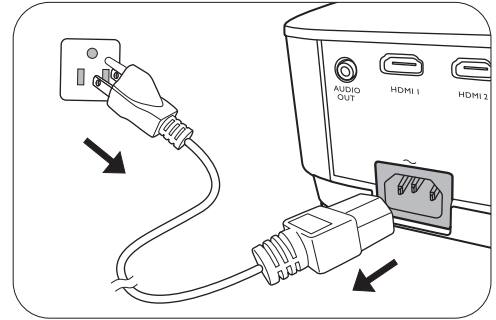

To protect the light source, the projector will not respond to any commands during the cooling process.

Menu operation

Please note that the on-screen display (OSD) menus vary according to the signal type selected and the projector model you are using.

The menu items are available when the projector detects at least one valid signal. If there is no equipment connected to the projector or no signal detected, limited menu items are accessible.

Menu System

Basic menu

Main menu	Options
Brightness	0~50~100
Aspect Ratio	Auto/Real/4:3/16:9/16:10
Picture Mode	LW500/LH500: Bright/Presentation/Spreadsheet/sRGB/ /Video/(3D)/User 1/User 2 LW500ST: Bright/Presentation/Golf/sRGB/ Video/(3D)/User 1/User 2
Volume	0~5~10
Light Mode	Normal/ECO/SmartEco
Information	Native Resolution
	Detected Resolution
	Source
	Picture Mode
	Light Mode
	3D Format
	Color System
	Light Usage Time
	Firmware Version
	Service Code
Menu Type	Basic/Advanced

Advanced menu



Main menu	Submenu	Options	
	Picture Mode	LW500/LH500: Bright/Presentation/Spreadsheet/sRGB/Video/(3D)/User 1/ User 2 LW500ST: Bright/Presentation/Golf/sRGB/Video/(3D)/User 1/User 2	
	Reference Mode	LW500/LH500: Presentation/Spreadsheet/sRGB/Video LW500ST: Presentation/Golf/sRGB/Video	
	Brightness	0~50~100	
	Contrast	-50~0~50	
	Color	-50~0~50	
	Tint	-50~0~50	
	Sharpness	0~15~31	
Picture	Gamma Selection	1.8/2.0/2.1/2.2/2.3/2.4/2.5/2.6/BenQ	
	Color Temperature Tuning	Color Temperature (Native/Cool/Normal/Warm)	
		R Gain (0~200)	
		G Gain (0~200)	
		B Gain (0~200)	
		R Offset (0~511)	
		G Offset (0~511)	
		B Offset (0~511)	
	Advanced Color Settings	Color Management	R (Primary Color/Hue/Saturation/Gain)
			G (Primary Color/Hue/Saturation/Gain)
			B (Primary Color/Hue/Saturation/Gain)
			C (Primary Color/Hue/Saturation/Gain)
			M (Primary Color/Hue/Saturation/Gain)
Y (Primary Color/Hue/Saturation/Gain)			
W (Primary Color/R Gain/B Gain/Gain)			
Reset			
Light Mode	Normal/ECO/SmartEco		
Wall Color	Off/Light Yellow/Pink/Light Green/Blue/Blackboard		
Reset Picture	Reset/Cancel		

Main menu	Submenu	Options	
Display	Aspect Ratio	Auto/Real/4:3/16:9/16:10	
	Keystone (LW500/LH500)	-40~0~40	
	2D Keystone (LW500ST)	H:	-30~0~30
		V:	-30~0~30
	Auto Vertical Keystone	-40~0~40	
	Corner Fit (LW500ST)	0~60	
	Test Pattern	On/Off	
	3D	3D Mode	Auto/Top Bottom/Frame Sequential/Frame Packing/Side by Side/Off
		3D Sync Invert	Disable/Invert
		Apply 3D Settings	3D Settings 1/3D Settings 2/3D Settings 3/Off
		Save 3D Settings	3D Settings 1/3D Settings 2/3D Settings 3
		HDMI Format	HDMI-1
	HDMI-2		YUV Limited/YUV Full
	Image Resizing	Digital Zoom	1.0X~1.8X/2.0X
		Digital Shrink & Shift	0.75X~1.0X
	Screen Fill (LW500ST)	16:10/16:9/4:3/1:1	
	Digital Lens Shift (LW500ST)		
	Fast Mode (LH500)	On/Off	
	Reset Display	Reset/Cancel	

Main menu	Submenu	Options		
Settings	Projector Installation	Front Table/Rear Table/Rear Ceiling/Front Ceiling		
	Auto Source Search	On/Off		
	Light Usage Time			
	Operation Settings	Blank Timer	Disable/5 min/10 min/15 min/20 min/25 min/30 min	
		Reminder Message	On/Off	
		High Altitude Mode	On/Off	
		Power On/Off Settings		Direct Power On
				Signal Power On
			Auto Power Off	
	Security Settings		Power Off Timer	
		Panel Key Lock	On/Off	
		Change Password		
		Power On Lock	On/Off	
	Baud Rate		9600/14400/19200/38400/57600/115200	
	HDMI Equalizer	HDMI-1 HDMI-2	Auto/1/2/3/4/5	
USB Power Switch		On/Off		
Reset Settings		Reset/Cancel		

Main menu	Submenu	Options	
System	Language	English/Français/Deutsch/Italiano/Español/ Русский/繁體中文/简体中文/日本語/한국어/ Svenska / Nederlands/Türkçe/Čeština/ Português/ไทย/Polski/Magyar/Hrvatski/ Română/Norsk/Dansk/Български/ Suomi/Bhs Ind / Ελληνικά/ العربية/ हिंदी / فارسی / Tiếng Việt	
	Standby Settings	Standby Mode	Eco/Normal
		Audio Pass Through	Off/HDMI-1/HDMI-2
	Background Settings	Background	BenQ/Black/Blue/Purple
		Splash Screen	BenQ/Black/Blue
	Menu Settings	Menu Type	Basic/Advanced
		Menu Display Time	5 sec/10 sec/20 sec/30 sec/Always
	Audio Settings	Mute	On/Off
		Volume	0~5~10
		Power On/Off Ring Tone	On/Off
	Factory Default	Reset/Cancel	
	Reset System	Reset/Cancel	
	Information	Native Resolution	
		Detected Resolution	
Source			
Picture Mode			
Light Mode			
3D Format			
Color System			
Light Usage Time			
Firmware Version			
Service Code			

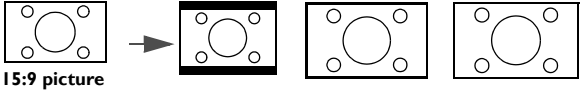
Basic menu

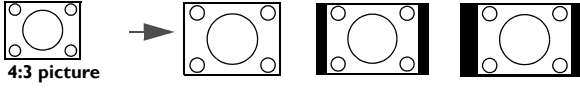
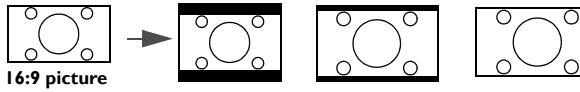
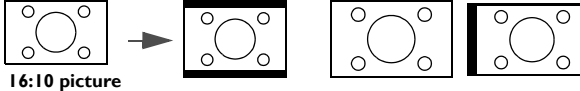

<p>Brightness</p>	<p>The higher the value, the brighter the image. Adjust this control so the black areas of the image appear just as black and that detail in the dark areas is visible.</p>
<p>Aspect Ratio</p>	<p>There are several options to set the image's aspect ratio depending on your input signal source.</p> <ul style="list-style-type: none"> <p>• Auto: Scales an image proportionally to fit the projector's native resolution in its horizontal or vertical width.</p>  <p>• Real: Projects an image as its original resolution and resizes it to fit within the display area. For input signals with lower resolutions, the projected image will be displayed in its original size.</p>   <p>• 4:3: Scales an image so that it is displayed in the center of the screen with a 4:3 aspect ratio.</p>  <p>• 16:9: Scales an image so that it is displayed in the center of the screen with a 16:9 aspect ratio.</p>  <p>• 16:10: Scales an image so that it is displayed in the center of the screen with a 16:10 aspect ratio.</p> 

Picture Mode	<p>The projector is preset with several predefined picture modes so that you can choose one to suit your operating environment and input signal picture type.</p> <ul style="list-style-type: none"> • Bright: Maximizes the brightness of the projected image. This mode is suitable for environments where extra-high brightness is required, such as using the projector in well lit rooms. • Presentation: Is designed for presentations. The brightness is emphasized in this mode to match PC and notebook coloring. • Spreadsheet: Designs for users who widely use excel and table to discuss financial numbers or quality numbers in meetings. • Golf: Is designed for golf simulators and optimizes the blue sky and the green grass color. • sRGB: Maximizes the purity of RGB colors to provide true-to-life images regardless of brightness setting. It is most suitable for viewing photos taken with an sRGB compatible and properly calibrated camera, and for viewing PC graphic and drawing applications such as AutoCAD. • Video: Is appropriate for playing video clips under ambient light. • 3D: Is appropriate for playing 3D images and 3D video clips. • User 1/User 2: Recalls the settings customized based on the current available picture modes. See Reference Mode on page 33.
Volume	Adjusts the sound level.
Light Mode	See Setting the Light Source Mode on page 44 .
Information	<ul style="list-style-type: none"> • Native Resolution: Shows the native resolution of the projector. • Detected Resolution: Shows the native resolution of the input signal. • Source: Shows the current signal source. • Picture Mode: Shows the selected mode in the Picture menu. • Light Mode: Shows the selected mode in the Light Source Mode menu. • 3D Format: Shows the current 3D mode. • Color System: Shows input system format. • Light Usage Time: Shows the number of hours the light source has been used. • Firmware Version: Shows the firmware version of your projector. • Service Code: Shows the service code of your projector.
Menu Type	Switches to the Advanced OSD menu. See Using the menus on page 22 .

Advanced menu

Picture

Picture Mode	<p>The projector is preset with several predefined picture modes so that you can choose one to suit your operating environment and input signal picture type.</p> <ul style="list-style-type: none">• Bright: Maximizes the brightness of the projected image. This mode is suitable for environments where extra-high brightness is required, such as using the projector in well lit rooms.• Presentation: Is designed for presentations. The brightness is emphasized in this mode to match PC and notebook coloring.• Spreadsheet: Design for users who widely use excel and table to discuss financial numbers or quality numbers in meetings.• Golf: Is designed for golf simulators and optimizes the blue sky and the green grass color.• sRGB: Maximizes the purity of RGB colors to provide true-to-life images regardless of brightness setting. It is most suitable for viewing photos taken with an sRGB compatible and properly calibrated camera, and for viewing PC graphic and drawing applications such as AutoCAD.• Video: Is appropriate for playing video clips under ambient light.• 3D: Is appropriate for playing 3D images and 3D video clips.• User 1/User 2: Recalls the settings customized based on the current available picture modes. See Reference Mode on page 33.
Reference Mode	<p>There are 2 user-definable modes if the current available picture modes are not suitable for your need. You can use one of the picture modes (except the User 1/User 2) as a starting point and customize the settings.</p> <ol style="list-style-type: none">1. Go to Picture > Picture Mode.2. Press ◀/▶ to select User 1 or User 2.3. Press ▼ to highlight Reference Mode, and press ◀/▶ to select a picture mode that is closest to your need.4. Press ▼ to select a menu item to be changed and adjust the value. The adjustments define the selected user mode.

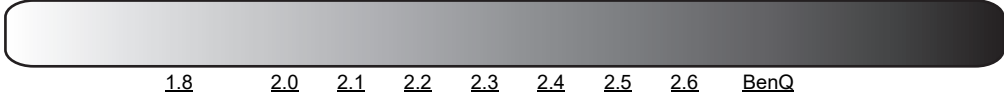
Brightness	The higher the value, the brighter the image. Adjust this control so the black areas of the image appear just as black and that detail in the dark areas is visible.
Contrast	The higher the value, the greater the contrast. Use this to set the peak white level after you have previously adjusted the Brightness setting to suit your selected input and viewing environment.
Color	<p>Lower setting produces less saturated colors. If the setting is too high, colors on the image will be overpowering, which makes the image unrealistic.</p>  <p>Only YUV color space is supported.</p>
Tint	<p>The higher the value, the more greenish the picture becomes. The lower the value, the more reddish the picture becomes.</p>  <p>Only YUV color space is supported.</p>
Sharpness	The higher the value, the sharper the picture becomes.
Advanced Color Settings	<p>Gamma Selection</p> <p>Gamma refers to the relationship between input source and picture brightness.</p> <ul style="list-style-type: none"> • 1.8/2.0/2.1/BenQ: Select these values according to your preference. • 2.2/2.3: Increases the average brightness of the picture. Best for a lit environment, meeting room or family room. • 2.4/2.5: Best for viewing movies in a dark environment. • 2.6: Best for viewing movies which are mostly composed of dark scenes. <p>High Brightness Low Contrast</p> <p>Low Brightness High Contrast</p> 
	<p>Color Temperature Tuning</p> <p>There are several preset color temperature settings available. The available settings may vary according to the signal type selected.</p> <ul style="list-style-type: none"> • Normal: Maintains normal colorings for white. • Cool: Makes images appear bluish white. • Native: With the light source's original color temperature and higher brightness. This setting is suitable for environments where high brightness is required, such as projecting pictures in well lit rooms. • Warm: Makes images appear reddish white. <p>You can also set a preferred color temperature by adjusting the following options.</p> <ul style="list-style-type: none"> • R Gain/G Gain/B Gain: Adjusts the contrast levels of Red, Green, and Blue. • R Offset/G Offset/B Offset: Adjusts the brightness levels of Red, Green, and Blue.

Color Management

This function provides six sets (RGBCMY) of colors to be adjusted. When you select each color, you can independently adjust its range and saturation according to your preference.

- **Primary Color:** Selects a color from among **R** (Red), **G** (Green), **B** (Blue), **C** (Cyan), **M** (Magenta), or **Y** (Yellow).
- **Hue:** Increase in the range will include colors consisted of more proportions of its two adjacent colors. Please refer to the illustration for how the colors relate to each other. For example, if you select Red and set its range at 0, only pure red in the projected picture will be selected. Increasing its range will include red close to yellow and red close to magenta.
- **Saturation:** Adjusts the values to your preference. Every adjustment made will reflect to the image immediately. For example, if you select Red and set its value at 0, only the saturation of pure red will be affected.

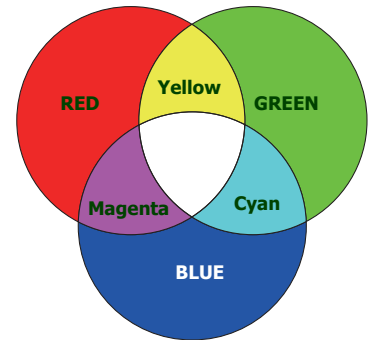

Advanced Color Settings



Saturation is the amount of that color in a video picture. Lower settings produce less saturated colors; a setting of “0” removes that color from the image entirely. If the saturation is too high, that color will be overpowering and unrealistic.

- **Gain:** Adjusts the values to your preference. The contrast level of the primary color you select will be affected. Every adjustment made will reflect to the image immediately.

If you selected **W**, you can modify the color temperature of white by adjusting the red/green/blue gain.

To return all the settings to the factory default values, highlight **Reset**, and press **OK**.

Light Mode

See [Setting the Light Source Mode on page 44](#).

Wall Color

Corrects the projected picture's color when the projection surface such as a painted wall which may not be white, the Wall Color feature can help correct the projected picture's colors to prevent possible color difference between the source and projected pictures. There are several precalibrated colors to choose from: **Light Yellow, Pink, Light Green, Blue, and Blackboard**.

Reset Picture

Returns all of the adjustments you've made for the **Picture** menu to the factory preset values.

Display

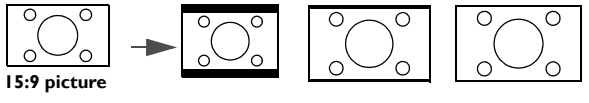
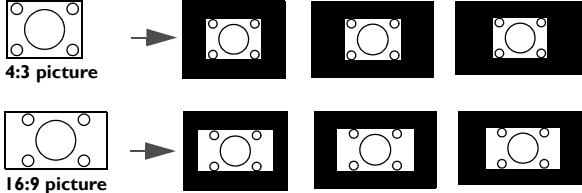
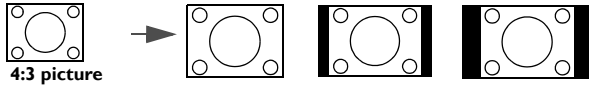
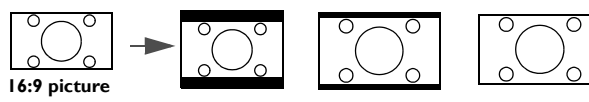
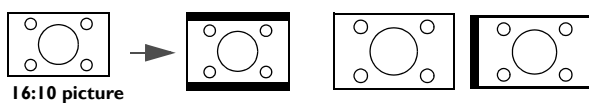
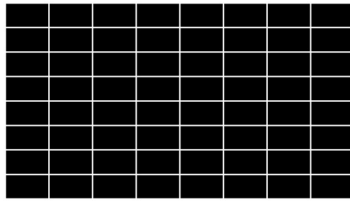
<p>Aspect Ratio</p>	<p>There are several options to set the image's aspect ratio depending on your input signal source.</p> <ul style="list-style-type: none"> Auto: Scales an image proportionally to fit the projector's native resolution in its horizontal or vertical width.  Real: Projects an image as its original resolution and resizes it to fit within the display area. For input signals with lower resolutions, the projected image will be displayed in its original size.  4:3: Scales an image so that it is displayed in the center of the screen with a 4:3 aspect ratio.  16:9: Scales an image so that it is displayed in the center of the screen with a 16:9 aspect ratio.  16:10: Scales an image so that it is displayed in the center of the screen with a 16:10 aspect ratio. 
<p>Keystone</p>	<p>Corrects any keystone of the image. See Correcting keystone on page 17.</p>
<p>2D Keystone</p>	
<p>Auto Vertical Keystone</p>	<p>When selecting Auto Vertical Keystone, projector image will automatically adjust the keystone.</p>
<p>Corner Fit</p>	<p>See Adjusting Corner Fit (LW500ST) on page 18.</p>
<p>Test Pattern</p>	<p>Adjusts the image size and focus and check that the projected image is free from distortion.</p> 









<p>3D</p>	<p>This projector features a 3D function which enables you to enjoy the 3D movies, videos, and sporting events in a more realistic way by presenting the depth of the images. You need to wear a pair of 3D glasses to view the 3D images.</p> <ul style="list-style-type: none"> • 3D Mode: The default setting is Off. If you want the projector to automatically choose an appropriate 3D format when detecting 3D contents, select Auto. If the projector cannot recognize the 3D format, press ▲/▼ to choose a 3D mode from among Top Bottom, Frame Sequential, Frame Packing and Side by Side. <p></p> <p>When 3D function is activated:</p> <ul style="list-style-type: none"> • The brightness level of the projected image will decrease. • The following settings cannot be adjusted: Picture Mode, Reference Mode. • The Keystone can only be adjusted within limited degrees. • 3D Sync Invert: When you discover the inversion of the image depth, enable this function to correct the problem. • Apply 3D Settings: After the 3D settings are saved, you can decide if you would like to apply them by choosing a set of 3D settings that you have saved. Once applied, the projector will automatically play the incoming 3D contents if it matches the 3D settings saved. <p></p> <p>Only the set(s) of 3D settings with memorized data is available.</p> <ul style="list-style-type: none"> • Save 3D Settings: When you have successfully displayed the 3D contents after making the appropriate adjustments, you can enable this function and choose a set of 3D settings to memorize current 3D settings.
<p>HDMI Format</p>	<p>Selects a suitable color format to optimize display quality.</p> <ul style="list-style-type: none"> • Auto: Automatically selects a suitable color space and gray level for the incoming HDMI signal. • RGB Limited: Utilizes the Limited range RGB 16-235. • RGB Full: Utilizes the Full range RGB 0-255. • YUV Limited: Utilizes the Limited range YUV 16-235. • YUV Full: Utilizes the Full range YUV 0-255.

Image Resizing	<p>Digital Zoom</p> <p>Magnifies or reduces the projected image size. After the Digital Zoom page displays, press ZOOM+/ZOOM- to reduce or magnify the image to a desired size. Press the directional arrows (▲, ▼, ◀, ▶) on the projector or remote control to navigate the picture.</p>  <p>The picture can only be navigated after it is magnified. You can further magnify the picture while searching for details.</p>
	<p>Digital Shrink & Shift</p> <p>Shrinks and/or shifts the projected image.</p> <ol style="list-style-type: none"> 1. After the adjustment bar displays, press ◀/▶ repeatedly to shrink or magnify the picture to a desired size. 2. Press OK to activate digital shift function. 3. After digital shift function is activated, press the directional arrows (▲, ▼, ◀, ▶) to shift the image. 4. Press AUTO to restore the picture to its original size.  <p>The picture can only be shifted after it shrank.</p>
Screen Fill	<p>The native resolution will change according to your selection.</p> <ul style="list-style-type: none"> • 16:10: Native resolution in the Information page will show 1280 × 800 accordingly. • 16:9: Native resolution in the Information page will show 1280 × 720 accordingly. Projection of all aspect ratio will be limited in 1280 × 720 range. • 4:3: Native resolution in the Information page will show 1024 × 768 accordingly. Projection of all aspect ratio will be limited in 1024 × 768 range. • 1:1: Native resolution in the Information page will show 800 × 800 accordingly. Projection of all aspect ratio will be limited in 800 × 800 range.  <ul style="list-style-type: none"> • This function is only available when the input source is HDMI or DisplayPort. • Aspect Ratio will be fixed at Auto if 16:9 or 4:3 is selected.
Digital Lens Shift	<p>Adjusts the image position horizontally. To move the projected image, use the directional arrow keys.</p>  <ul style="list-style-type: none"> • This function is only available when the input source is HDMI or DisplayPort. • Once the Screen Fill value is adjusted, the Digital Lens Shift value will be reset to "0". • This function is not available when the 3D function is activated or when Screen Fill is set at 16:10.

Fast Mode	<p>Minimizes the response time between the input source and the displayed image. For the optimized latency, when Fast Mode is activated, Keystone/Aspect Ratio will return to the default settings.</p> <p>*Fast Mode can only be enabled for below input timing adopted by most of popular games:</p> <ul style="list-style-type: none"> - 1080p 60Hz/120Hz/240Hz - 4K 60Hz
Reset Display	Returns all of the adjustments you've made for the Display menu to the factory preset values.



Settings

Projector Installation	See Choosing a location on page 12 .
Auto Source Search	Allows the projector to automatically search for a signal.
Light Usage Time	Displays the number of hours the light source has been used.

Operation Settings	<p>Blank Timer</p> <p>Sets the image blank time when there is no action taken on the blank screen, once elapsed the image will return to the screen. If the preset time spans are not suitable for your need, select Disable. No matter Blank Timer is activated or not, you can press most of the keys on the projector or remote control to restore the picture.</p>
	<p>Reminder Message</p> <p>Sets the reminder messages on or off.</p>
	<p>High Altitude Mode</p> <p>We recommend you use the High Altitude Mode when your environment is between 1500 m –3000 m above sea level, and ambient temperature is between 0°C–30°C.</p> <p>Operation under "High Altitude Mode" may cause a higher decibel operating noise level because of increased fan speed necessary to improve overall system cooling and performance.</p> <p>If you use this projector under other extreme conditions excluding the above, it may display auto shut-down symptoms, which is designed to protect your projector from over-heating. In cases like this, you should switch to High Altitude mode to solve these symptoms. However, this is not to state that this projector can operate under any and all harsh or extreme conditions.</p> <p></p> <p>Do not use the High Altitude Mode if your altitude is between 0 m and 1500 m and ambient temperature is between 0°C and 35°C. The projector will be over cooled, if you turn the mode on under such a condition.</p>
	<p>Power On/Off Settings</p> <ul style="list-style-type: none"> • Direct Power On: Allows the projector to turn on automatically once the power is fed through the power cord. • Signal Power On: Sets whether to turn the projector directly on without pressing  POWER or  ON when the projector is in standby mode and detects a VGA signal or a HDMI signal with 5V power. • Auto Power Off: Allows the projector to turn off automatically if no input signal is detected after a set period of time to prevent unnecessary waste of light source life. • Power Off Timer: Sets the auto-shutdown timer.
	<p>Security Settings</p> <p>See Utilizing the password function on page 23.</p>
<p>Baud Rate</p> <p>Selects a baud rate that is identical with your computer's so that you can connect the projector using a suitable RS-232 cable and update or download the projector's firmware. This function is intended for qualified service personnel.</p>	
<p>HDMI Equalizer</p> <p>Adjusts the equalizer gain settings for an HDMI signal. The higher the setting, the stronger the gain value. If there are more than one HDMI port on the projector, select the HDMI port first before adjusting the value.</p>	

USB Power Switch	Disables or enables "Type A connector" 5V power output. To enable this function, select On . Select Off when PointWrite Touch Module is not in use to prevent damage.
Reset Settings	Returns all of the adjustments you've made for the Settings menu to the factory preset values.

System

Language	Sets the language for the On-Screen Display (OSD) menus.
Standby Settings	<ul style="list-style-type: none"> • Standby Mode <ul style="list-style-type: none"> • ECO: The projector maintains at standby mode with less than 0.5W power consumption. • Normal: Allows the projector to provide the Audio Pass Through function in standby mode.  <p>No power is provided from the USB port when the projector is in standby mode.</p> <ul style="list-style-type: none"> • Audio Pass Through: The projector can play sound when it is in standby mode and the corresponding jacks are correctly connected to devices. Press ◀/▶ to choose the source that you wish to use. See Connection on page 19 for how to make the connection.
Background Settings	<ul style="list-style-type: none"> • Background: Sets the background color for the projector. • Splash Screen: Allows you to select which logo screen will be displayed during projector start-up.
Menu Settings	<ul style="list-style-type: none"> • Menu Type: Switches to the Basic OSD menu. See Using the menus on page 22. • Menu Display Time: Sets the length of time the OSD will remain active after your last key press.
Audio Settings	<ul style="list-style-type: none"> • Mute: Temporarily turns off the sound. • Volume: Adjusts the sound level. • Power On/Off Ring Tone: Turns on or off the ring tone when the projector is in startup and shutdown process.  <p>The only way to change Power On/Off Ring Tone is setting On or Off here. Setting the sound mute or changing the sound level will not affect the Power On/Off Ring Tone.</p>
Factory Default	<p>Returns all settings to the factory preset values.</p>  <p>The following settings will still remain: Keystone, 2D Keystone, Projector Installation, Light Usage Time, High Altitude Mode, Security Settings, Baud Rate, HDMI Equalizer.</p>
Reset System	Returns all of the adjustments you've made for the System menu to the factory preset values.

Information

Information	<ul style="list-style-type: none">• Native Resolution: Shows the native resolution of the projector.• Detected Resolution: Shows the native resolution of the input signal.• Source: Shows the current signal source.• Picture Mode: Shows the selected mode in the Picture menu.• Light Mode: Shows the selected mode in the Light Settings menu.• 3D Format: Shows the current 3D mode.• Color System: Shows input system format.• Light Usage Time: Shows the number of hours the light source has been used.• Firmware Version: Shows the firmware version of your projector.• Service Code: Shows the service code of your projector.
--------------------	---

Maintenance

Care of the projector

Cleaning the lens

Clean the lens whenever you notice dirt or dust on the surface. Please be sure to turn off the projector and let it cool down completely before cleaning the lens.

- Use a canister of compressed air to remove dust.
- If there is dirt or smears, use lens-cleaning paper or moisten a soft cloth with lens cleaner and gently wipe the lens surface.
- Never use any type of abrasive pad, alkaline/acid cleaner, scouring powder, or volatile solvent, such as alcohol, benzene, thinner or insecticide. Using such materials or maintaining prolonged contact with rubber or vinyl materials may result in damage to the projector surface and cabinet material.

Cleaning the projector case

Before you clean the case, turn the projector off using the proper shutdown procedure as described in [Shutting down the projector on page 25](#) and unplug the power cord.

- To remove dirt or dust, wipe the case with a soft, lint-free cloth.
- To remove stubborn dirt or stains, moisten a soft cloth with water and a neutral pH detergent. Then wipe the case.



Never use wax, alcohol, benzene, thinner or other chemical detergents. These can damage the case.

Storing the projector

If you need to store the projector for an extended time, please follow the instructions below:

- Make sure the temperature and humidity of the storage area are within the recommended range for the projector. Please refer to [Specifications on page 47](#) or consult your dealer about the range.
- Retract the adjuster feet.
- Remove the battery from the remote control.
- Pack the projector in its original packing or equivalent.

Transporting the projector

It is recommended that you ship the projector with its original packing or equivalent.

Light source information

Getting to know the light hour

When the projector is in operation, the duration (in hours) of light source usage is automatically calculated by the built-in timer. The method of calculating the equivalent light hour is as follows:

1. Light Usage Time = (x+y+z) hours, if
Time used in **Normal** mode = x hours
Time used in **ECO** mode = y hours
Time used in **SmartEco** mode = z hours

2. Equivalent Light Hour = α hours

$$\alpha = \frac{A'}{X} \times x + \frac{A'}{Y} \times y + \frac{A'}{Z} \times z \quad , \text{ if}$$

X= light source life spec of **Normal** mode

Y= light source spec of **ECO** mode

Z= light source spec of **SmartEco** mode

A' is the longest light life spec among X, Y, Z.



For time used in each light source mode shown in OSD menu:

- Time used is accumulated and rounded down to an integer in **hours**.
- When time used is less than 1 hour, it shows 0 hours.



When you calculate **Equivalent Light Hours** manually, it will probably have deviation from the value shown in OSD menu since projector system calculates time used for each light source mode in “Minutes” then rounds down to an integer in hours shown in OSD.

To obtain the light source hour information:

1. Go to **Advanced Menu - Settings > Light Usage Time** and press **OK**.
2. The **Light Usage Time** information is displayed.

You can also get the light source hour information on the **Information** menu.

Extending light source life

- Setting the **Light Source Mode**

Go to **Advanced Menu - Picture > Advanced Color Settings > Light Source Mode** and select a suitable light source power from among the provided modes.

Setting the projector in **ECO** or **SmartEco** mode extends light source life.







































Light mode	Description
Normal	Provides full light source brightness
ECO	Lowers brightness to extend the light source life and decreases the fan noise
SmartEco	Adjusts the light source power automatically depending on the content brightness level while optimizing display quality









- Setting **Auto Power Off**

This function allows the projector to turn off automatically if no input signal is detected after a set period of time to prevent unnecessary waste of light source life.

To set **Auto Power Off**, go to **Advanced Menu - Settings > Operation Settings > Power On/Off Settings > Auto Power Off** and press **◀/▶**.

Indicators

Light			Status & Description
POWER ○	TEMP ○	LIGHT ○	
Power events			
			Stand-by mode
			Powering up
			Normal operation
			Normal power-down cooling
			Download
			Data abort, scaler shutdown abnormally
Burn-in events			
			Burn-in on
			Burn-in off
Light events			
			Light life exhausted
			Light error in normal operation
Thermal events			
			Fan 1 error (the actual fan speed is outside the desired speed)
			Fan 2 error (the actual fan speed is outside the desired speed)
			Temperature 1 error (over limited temperature)

	 : Off	 : Orange On	 : Green On	 : Red On
		 : Orange Flashing	 : Green Flashing	 : Red Flashing

Troubleshooting

? The projector does not turn on.

Cause	Remedy
There is no power from the power cord.	Plug the power cord into the AC power jack on the projector, and plug the power cord into the power outlet. If the power outlet has a switch, make sure that it is switched on.
Attempting to turn the projector on again during the cooling process.	Wait until the cooling down process has completed.

? No picture

Cause	Remedy
The video source is not turned on or connected correctly.	Turn the video source on and check that the signal cable is connected correctly.
The projector is not correctly connected to the input signal device.	Check the connection.
The input signal has not been correctly selected.	Select the correct input signal with the SOURCE key.

? Blurred image

Cause	Remedy
The projection lens is not correctly focused.	Adjust the focus of the lens using the focus ring.
The projector and the screen are not aligned properly.	Adjust the projection angle and direction as well as the height of the projector if necessary.
The lens cover is still closed.	Open the lens cover.

? Abnormal image

Cause	Remedy
The image is abnormal.	<ul style="list-style-type: none"> • Ensure the video source cable is connected properly, and that the video source is turned on. • Ensure that the air intake or exhaust is not blocked.

? Remote control does not work.

Cause	Remedy
The batteries are out of power.	Replace both of the batteries with new ones.
There is an obstacle between the remote control and the projector.	Remove the obstacle.
You are too far away from the projector.	Stand within 8 meters (26 feet) of the projector.

? The password is incorrect.

Cause	Remedy
You do not remember the password.	See Entering the password recall procedure on page 24 .

Specifications

Projector specifications



All specifications are subject to change without notice.

Optical

Resolution

LW500/LW500ST: 1280 x 800 WXGA

LH500: 1920 x 1080 1080p

Display system

1-CHIP DMD

Lens

LW500/LH500: F = 2.56 ~ 2.68, f = 22 ~ 24.1 mm

LW500ST: F = 2.6 ~ 2.78, f = 10.2 ~ 12.24 mm

Light source

LED

Electrical

Power supply

AC100–240V, 2.2 A, 50–60 Hz (Automatic)

Power consumption

200 W (Max); < 0.5 W (Standby)

Mechanical

Weight

2.3 Kg ± 100 g (5.1 lbs ± 0.22 lbs)

Output terminals

Speaker

LW500/LH500: 2 watt x1

LW500ST: 10 watt x 1

Audio signal output

PC audio jack x 1

Control

USB

Type-A power supply 5V /1.5 A x 1

RS-232 serial control

9 pin x 1

IR receiver x 2

Input terminals

Video signal input

SD/HDTV signal input

Digital - HDMI x 2

Environmental Requirements

Operating temperature

0°C–40°C at sea level

Operating relative humidity

10%–90% (without condensation)

Operating altitude

0–1499 m at 0°C–35°C

1500–3000 m at 0°C–30°C (with High Altitude Mode on)

Storage temperature

-20°C–60°C at sea level

Storage humidity

10%–90% RH (without condensation)

Storage altitude

30°C@ 0~12,200m above sea level

Transporting

Original packing or equivalent is recommended

Repairing

Please visit below website and choose your country to find your service contact window.

<http://www.benq.com/welcome>

Dimensions

LW500/LH500

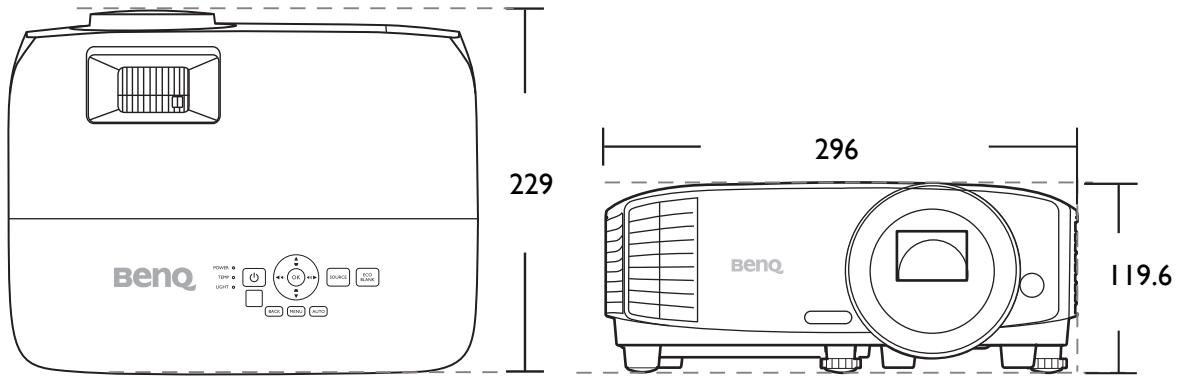

LW500ST

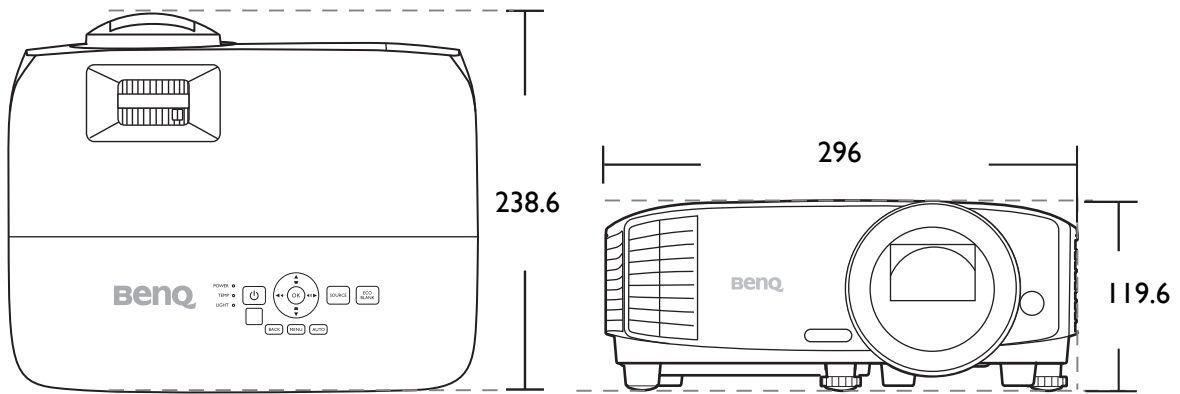

Unit: mm

Timing chart

Supported timing for HDMI (HDCP) input

- PC timings

Resolution	Mode	Vertical Frequency (Hz)	Horizontal Frequency (kHz)	Pixel Frequency (MHz)	Supported 3D format		
					Frame Sequential	Top Bottom	Side by Side
640 x 480	VGA_60	59.940	31.469	25.175	Supported	Supported	Supported
	VGA_72	72.809	37.861	31.500			
	VGA_75	75.000	37.500	31.500			
	VGA_85	85.008	43.269	36.000			
720 x 400	720 x 400_70	70.087	31.469	28.3221			
800 x 600	SVGA_60	60.317	37.879	40.000	Supported	Supported	Supported
	SVGA_72	72.188	48.077	50.000			
	SVGA_75	75.000	46.875	49.500			
	SVGA_85	85.061	53.674	56.250			
1024 x 768	SVGA_120 (Reduce Blanking)	119.854	77.425	83.000	Supported		
	XGA_60	60.004	48.363	65.000	Supported	Supported	Supported
	XGA_70	70.069	56.476	75.000			
	XGA_75	75.029	60.023	78.750			
	XGA_85	84.997	68.667	94.500			
1024 x 768	XGA_120 (Reduce Blanking)	119.989	97.551	115.5	Supported		
1152 x 864	1152 x 864_75	75	67.5	108			
1024 x 576@60Hz	BenQ Notebook Timing	60.00	35.820	46.996			
1024 x 600@65Hz	BenQ Notebook Timing	64.995	41.467	51.419			
1280 x 720	1280 x 720_60	60	45.000	74.250	Supported	Supported	Supported
1280 x 768	1280 x 768_60	59.870	47.776	79.5	Supported	Supported	Supported
1280 x 800	WXGA_60	59.810	49.702	83.500	Supported	Supported	Supported
	WXGA_75	74.934	62.795	106.500			
	WXGA_85	84.880	71.554	122.500			
	WXGA_120 (Reduce Blanking)	119.909	101.563	146.25	Supported		
1280 x 1024	SXGA_60	60.020	63.981	108.000		Supported	Supported
	SXGA_75	75.025	79.976	135.000			
	SXGA_85	85.024	91.146	157.500			
1280 x 960	1280 x 960_60	60.000	60.000	108		Supported	Supported
	1280 x 960_85	85.002	85.938	148.500			
1360 x 768	1360 x 768_60	60.015	47.712	85.500		Supported	Supported
1440 x 900	WXGA+_60	59.887	55.935	106.500		Supported	Supported
1400 x 1050	SXGA+_60	59.978	65.317	121.750		Supported	Supported
1600 x 1200	UXGA	60.000	75.000	162.000		Supported	
1680 x 1050	1680 x 1050_60	59.954	65.290	146.250		Supported	Supported
640 x 480@67Hz	MAC13	66.667	35.000	30.240			
832 x 624@75Hz	MAC16	74.546	49.722	57.280			
1024 x 768@75Hz	MAC19	75.020	60.241	80.000			
1152 x 870@75Hz	MAC21	75.06	68.68	100.00			
1920 x 1080@60Hz	1920 x 1080_60	60	67.5	148.5	Supported	Supported	Supported
1920 x 1200@60Hz	1920 x 1200_60 (Reduce Blanking)	59.950	74.038	154.0000	Supported	Supported	Supported



The timings showing above may not be supported due to EDID file and VGA graphic card limitations. It is possible that some timings cannot be chosen.

• Video timings

Timing	Resolution	Vertical Frequency (Hz)	Horizontal Frequency (kHz)	Pixel Frequency (MHz)	Supported 3D format			
					Frame Sequential	Frame Packing	Top Bottom	Side by Side
480i	720 (1440) x 480	59.94	15.73	27	Supported			
480p	720 x 480	59.94	31.47	27	Supported			
576i	720 (1440) x 576	50	15.63	27				
576p	720 x 576	50	31.25	27				
720/50p	1280 x 720	50	37.5	74.25		Supported	Supported	Supported
720/60p	1280 x 720	60	45.00	74.25	Supported	Supported	Supported	Supported
1080/24P	1920 x 1080	24	27	74.25		Supported	Supported	Supported
1080/25P	1920 x 1080	25	28.13	74.25				
1080/30P	1920 x 1080	30	33.75	74.25				
1080/50i	1920 x 1080	50	28.13	74.25				Supported
1080/60i	1920 x 1080	60	33.75	74.25				Supported
1080/50P	1920 x 1080	50	56.25	148.5			Supported	Supported
1080/60P	1920 x 1080	60	67.5	148.5	Supported		Supported	Supported