

MULTI-FORMAT AV MIXER

VR-50HD MK II



Connect the ground terminal to an external ground point before use

In order to stabilize the connections between this unit and external devices, and to prevent malfunctions or faulty operation caused by static electricity, you should connect the ground terminal of this unit to an external ground point before use. Use the included ground cord to make this connection.

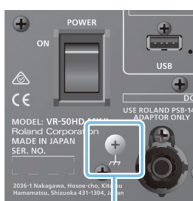

Ground terminal

- * Before connecting the ground cord or any external devices, you must minimize the volume of all devices and turn off the power of all devices in order to prevent faulty operation or malfunctions.
- * Unsuitable places for connection
 - Water pipes (may result in shock or electrocution)
 - Gas pipes (may result in fire or explosion)
 - Telephone-line ground or lightning rod (may be dangerous in the event of lightning)
- * If you connect the ground terminal to an external ground point, a slight hum might occur.
- * If you do not understand how to connect the ground terminal, contact the nearest Roland Service Center.

- Roland is an either registered trademark or trademark of Roland Corporation in the United States and/or other countries.
- Company names and product names appearing in this document are registered trademarks or trademarks of their respective owners.

Contents

Panel Descriptions	4	Menu List	37
Top Panel	4	Audio	37
Rear Panel	6	Audio Ch. 1–4 Screen	37
Basic Operations	7	Audio Ch. 5/6–11/12 Screen	39
Turning the Power On/Off	7	Output Screen	41
Operating the Menu	7	EQ/Dynamics Screen	42
Switching the Monitor View Modes	8	15Band EQ Screen	43
Video Input/Output Settings	9	Auto Mixing Screen	43
List of Compatible Video Formats	9	Video Follows Audio Screen	44
Setting the Output Format	10	Reverb/Delay Screen	44
Assigning Video Sources	10	Video	45
Inputting Copy-Protected (HDCP) Video	11	Video Input 1–4 Screen	45
Assigning Video Buses to Output Connectors	12	Video Input Still Screen	47
Selecting the Video Sent to the AUX Bus	12	Video Output Screen	47
Video Operations	13	Input Assign Screen	48
Switching the Video	13	Transition Setup Screen	48
Outputting a Loaded Still Image	13	Composition Setup Screen	49
Loading a Still Image	14	Test Pattern screen	52
Capturing a Still Image from Output Video	14	Still Load/Delete screen	52
Loading a Still Image from a USB Flash Drive	15	Capture/Freeze/Logo Screen	52
Switching the Video Automatically (Video Follows Audio) ..	16	System	53
Fading-In/Out the Program Output Video	16	USB Streaming Screen	53
Freezing the Program Output Video (Freeze)	17	Memory Screen	53
Inserting a Still Image in the Program Output (User Logo) ..	17	Setup Screen	54
Video Composition Operations	18	Network	55
About the Video Compositing Layer Hierarchy	18	LAN Screen	55
Compositing Using Picture-in-Picture (PinP)	19	Camera Screen	55
Compositing Two Inset Screens	20	LAN/RS-232C Command Reference	57
Compositing Using Key	21	LAN Interface	57
Compositing a Logo or Image (Luminance Key)	21	RS-232C Interface	57
Compositing a Subject and Background (Chroma Key) ..	22	Command Format	57
Compositing a Still Image Loaded into the Unit (Luminance/Chroma Key) ..	23	List of Commands	58
Audio Operations	24	Appendices	60
Assigning Audio Sources to Audio Channels	24	Troubleshooting	60
Adjusting the Input Gain (Sensitivity)	24	Main Specifications	61
Adjusting the Volume Balance	25	Dimensions	63
Correcting a Time Difference Between Video and Audio (Delay) ..	25	Video Block Diagram	64
Applying Effects to Input Audio	26	Audio Block Diagram	65
Applying Effects to Output Audio	27		
Interlinking Audio Output to Video Switching (Audio Follow)	27		
Controlling Volume Levels Automatically (Auto Mixing) ..	28		
Checking a Specific Audio (Solo)	28		
Muting Only Specific Audio (Mute)	28		
Outputting AUX-bus Audio	29		
Remotely Controlling a Camera	30		
Live Streaming	32		
Outputting Video/Audio to a Computer for Streaming	32		
Other Features	33		
Saving/Recalling Settings (Memory)	33		
Saving the Unit's Settings on a USB Flash Drive	34		
Formatting a USB Flash Drive	35		
Renaming the Monitor Label	35		
Returning to the Factory Settings (Factory Reset)	36		

Panel Descriptions

Top Panel

Audio Mixer Section (Input channels 1–11/12, MAIN bus)

- 1 [GAIN] knobs (p. 24)**
Adjust the gain (sensitivity) of the audio that is being input from the AUDIO IN 1–4 jacks.
- 2 [SELECT] buttons**
Accesses a menu screen related to audio input and output.
- 3 [SOLO] buttons (p. 28)**
Turn the solo function on/off. Only the audio for which this is on (lit) is heard in the headphones.
* The audio for which the solo function is on can also be output from the AUX 2/MONITOR OUT jacks.
- 4 Level meters**
Indicate the input level.
- 5 [MUTE] buttons (p. 28)**
Turn the mute function on/off. When this is on (lit), the audio is temporarily silenced.
- 6 Audio faders (p. 25)**
Adjust the input level.
- 7 [MIC 5 GAIN] [MIC 7 GAIN] knobs (p. 24)**
Adjust the input gain (sensitivity) of the mic connected to the MIC 5 or MIC 7 jack.
- 8 SIG/PEAK indicator**
Indicates the output level of the USB audio. When the output level exceeds -48 dB, this is lit green. When output overload occurs, this is lit red.
- 9 [USB AUDIO] knob (p. 32)**
Adjusts the output level of the USB audio.
- 10 [PHONES] knob**
Adjusts the volume of the headphones.
- 11 INPUT indicators**

Indicator	Explanation	
MIC		
LINE	Indicates the audio source that is currently selected (p. 24).	
VIDEO		
FOLLOW	When the Audio Follow function is on, this indicates the output status of the audio (p. 27).	
	Lit green	Audio is not being output.
	Lit red	Audio is being output.
	Blinking red	Audio is being faded-in/out.
* Audio follow is a function that automatically switches the audio output in tandem with video switching.		

- 12 MAIN level meter (p. 25)**
Indicates the output level.
- 13 [MAIN] fader (p. 25)**
Adjusts the output level.

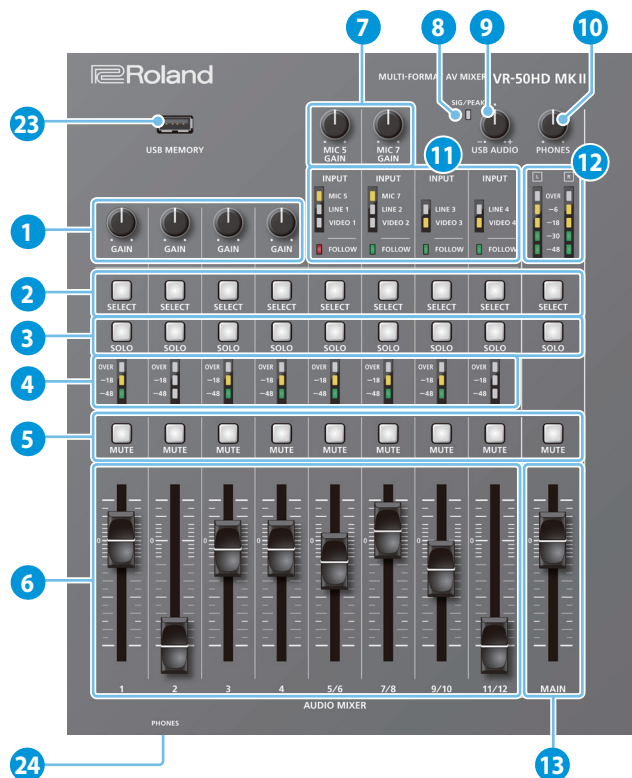

Video Mixer Section

- 14 MONITOR (p. 8)**
Here you can switch the monitor display. The selected button is lit.
[MULTI-VIEW] button
Shows a list of the input/output video and the loaded still images.
[INPUT] button
Shows the input videos in four quarters of the screen.
[STILL] button
Shows the loaded still images in four quarters of the screen.
[PGM] button
Shows the program output video.
- 15 TRANSITION (p. 13)**
[CUT] [MIX] [WIPE] buttons
Select video transition effects. The selected button is lit.
[TIME] knob
Adjusts the video transition time.
- 16 [FREEZE/USER LOGO] button (p. 17)**
Turns the freeze function (freeze the output video) on/off. When on, the button is lit.
* You can also assign the user logo function (output a still image) to the [FREEZE/USER LOGO] button (p. 17).
- 17 [OUTPUT FADE] button (p. 16)**
The program output video and audio fade-in/out.

Button	Status
Lit	Fade-out completed
Blinking	Fading-in/out
Unlit	Normal output
- 18 AUX [1]–[4] [PinP] [PinP/KEY] [PGM] buttons (p. 12)**
Select the video that is sent to the AUX bus. The selected button is lit.

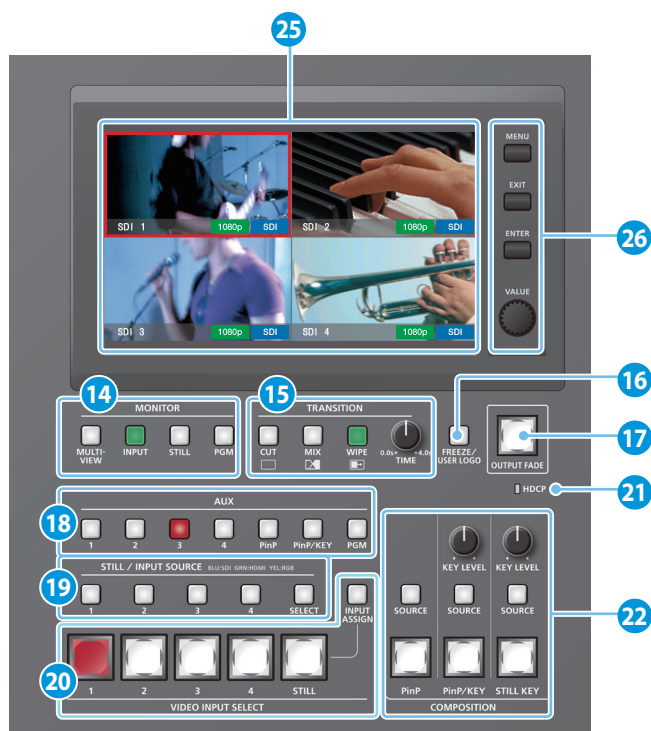

Common Controllers

- 23 USB MEMORY port (p. 15, 34)**
Connect a USB flash drive here. It is used when loading a still image, or when saving or loading settings.
- 24 PHONES jacks (Front panel)**
Connect headphones here. Two sets of headphones can be used simultaneously.
- 25 Monitor (touch panel)**
Shows the input/output video, a loaded still image, or a menu screen. Touch the screen to select a menu item.
- 26 Menu operation area (p. 7)**
 - [MENU] button**
Switches the menu screen between visible and hidden.
 - [EXIT] button**
Returns you to the menu one level higher.
 - [ENTER] button**
Executes an operation.
 - [VALUE] knob**
Selects a menu item, or edits the value of a setting.

19 STILL/INPUT SOURCE (p. 10, 13)

[SELECT] button

Selects the function of the [1]–[4] buttons. Each time you press the button, it cycles in the order of lit green → lit red → unlit (no function).

[1]–[4] buttons

- When the [SELECT] button is lit green (p. 10)
Select the video source that is assigned to each VIDEO INPUT SELECT [1]–[4] button. The lit color of the button indicates the video source.

Lit color	Video source	Lit color	Video source
Blue	SDI IN	Magenta	COMPOSITE IN
Green	HDMI IN	Yellow	RGB/COMPONENT IN

- When the [SELECT] button is lit red (p. 13)
Select the still image that is assigned to the VIDEO INPUT SELECT [STILL] button. The selected button is lit red.

20 VIDEO INPUT SELECT

[1]–[4] [STILL] buttons (p. 13)

Select the video that is output: an input video (1–4) or the still image (STILL). The selected button is lit.

[INPUT ASSIGN] button (p. 10)

Shows a menu screen where you can select the video source for the [1]–[4] buttons.

21 HDCP indicator (p. 11)

This indicator is lit, blinking, or unlit according to the HDCP (copy protection) setting and according to whether an HDCP-compliant device is connected.

22 COMPOSITION

[PinP] button (p. 19)

Turns PinP (picture-in-picture) composition on/off. When on, the button is lit.

[SOURCE] button

Shows a menu screen where you can select the inset screen video.

[PinP/KEY] button (p. 20–22)

Turns “PinP + key” composition on/off. When on, the button is lit.

[SOURCE] button

Shows a menu screen where you can select the video that will be composited.

[KEY LEVEL] knob

Adjusts the degree of extraction (transparency) for the key.

[STILL KEY] button (p. 23)

Turns on/off key composition using a still image (logo or image). When on, the button is lit.

[SOURCE] button

Shows a menu screen where you can select the still image that will be composited.

[KEY LEVEL] knob

Adjusts the degree of extraction (transparency) for the key.

What is program (PGM) output?

This is the video output that reflects all processing, such as video compositing. With the factory settings, this is output from the PGM connector.

This is the video that is seen by the people who are watching the live stream or presentation.

Rear Panel

* To prevent malfunction and equipment failure, always turn down the volume, and turn off all the units before making any connections.

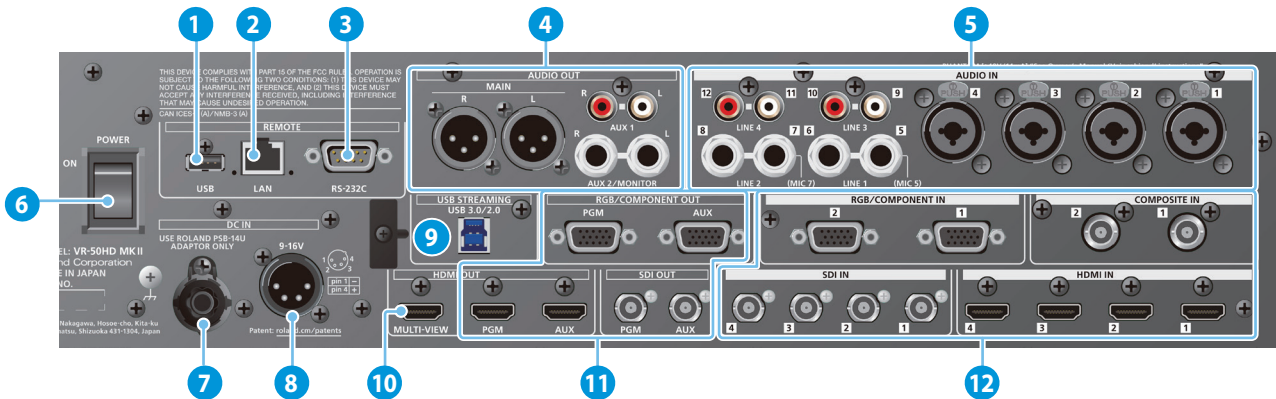

1 USB port

Connect a USB flash drive here. This is used to update the system program.

2 LAN port (p. 57)

Lets you remotely control this unit by using terminal software, etc.

3 RS-232C connector (p. 57)

You can connect this to a computer equipped with an RS-232C connector, and remotely control this unit.

4 MAIN jacks, AUX 1 jacks, AUX 2/MONITOR jacks

These jacks output audio. Choose the jacks that are appropriate for the connected devices.

For each jack, you can change the audio bus (MAIN, AUX 1, AUX 2) that is assigned for output from that jack (p. 12). With the factory settings, the bus assignments are as follows.

MAIN jacks	MAIN bus
AUX 1 jacks	AUX 1 bus
AUX 2/MONITOR jacks	AUX 2 bus

* Pin assignment of MAIN (XLR) jacks, AUX 2/MONITOR (TRS) jacks



5 AUDIO IN 1-4 jacks, LINE 1-4 jacks, MIC 5/7 jacks

These jacks input audio. Choose the jacks that are appropriate for the connected devices.

* Pin assignment of AUDIO IN 1-4 (TRS/XLR) jacks, LINE 1-2 (TRS) jacks



*** About phantom power**

You can supply phantom power (+48 V) from the AUDIO IN 1-4 jacks (XLR). Turn on phantom power when you're using a condenser microphone that requires phantom power.

Use the [MENU] button → Audio <1>-<4> → set "+48V" to "ON."

6 [POWER] switch (p. 7)

Turns the power on/off.

7 AC adaptor jack

Connect the included AC adaptor to this jack.

* Use the cord hook to secure the cord of the AC adaptor as shown in the illustration.



8 External power supply connector (p. 7)

Connect the external power supply here.

9 USB STREAMING port (p. 32)

Outputs the audio and video to your computer.

* If you are outputting HD video via USB, connect this to a USB 3.0 port of your computer.

* If you connect via an extension cable or a USB hub, the computer might not recognize this unit. We recommend that you connect this unit directly to your computer.

10 MULTI-VIEW connector

Outputs a list of the input/output video and the loaded still images. The screen layout is the same as when this unit's monitor is in multi-view mode (p. 8).

* The output format fixed at 1080/60p.

11 PGM connectors, AUX connectors (RGB/COMPONENT OUT, HDMI OUT, SDI OUT)

These connectors output video. Choose the connectors that are appropriate for the connected devices.

For each connector, you can change the video bus (PGM, PVW, AUX) that is assigned for output from that connector (p. 12). With the factory settings, the bus assignments are as follows.

PGM connectors	PGM bus (program video)
AUX connectors	AUX bus

12 RGB/COMPONENT IN 1-2 connectors

COMPOSITE IN 1-2 connectors, SDI IN 1-4 connectors, HDMI IN 1-4 connectors

These connectors input video. Choose the connectors that are appropriate for the connected devices.

The input format is automatically recognized.

NOTE

Do not block the cooling-fan intake and exhaust ports on the side panels. If the cooling-fan intake and exhaust ports are blocked, the internal temperatures may rise, causing malfunctions due to excessive heat.

Basic Operations

Turning the Power On/Off

Once everything is properly connected, be sure to follow the procedure below to turn on their power. If you turn on equipment in the wrong order, you risk causing malfunction or equipment failure.

- * Before turning the unit on/off, always be sure to turn the volume down. Even with the volume turned down, you might hear some sound when switching the unit on/off. However, this is normal and does not indicate a malfunction.

Turning the power on

1. Make sure that all devices are powered-off.
2. Turn on this unit's [POWER] switch.

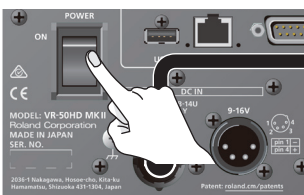

3. Turn on the power in the order of source devices → output devices.

Turning the power off

1. Turn off the power in the order of output devices → source devices.
2. Turn off this unit's [POWER] switch.

About the external power supply

You can use an external power supply to supply power. If you use both the AC adaptor power supply and an external power supply simultaneously, the AC adaptor power supply operates as the "main power supply" and the external power supply operates as the "backup power supply."

Use an external power supply that satisfies the following conditions.

- Equipped with a current limiting function
- Able to supply 90 W or more of power
- * Please also read the owner's manual of the external power supply that you're using.

NOTE

- Check whether this unit's external power supply connector matches the wiring of the external power supply that you're using. Connecting an external power supply whose wiring differs will cause malfunctions.

Pin wiring of the external power supply connector



Pin number	Signal name
1	-
4	+

- You must supply power in the range of DC 9 V–16 V. Using a voltage outside this range will cause the external power supply or this unit to malfunction.

Operating the Menu

Here's how to access the menu, and make video/audio settings and settings for this unit.

1. Press the [MENU] button to display the MENU screen.

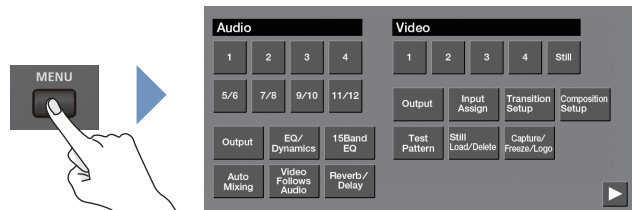

2. Touch a button in the screen to select a menu item.

The menu screen of the selected item appears.

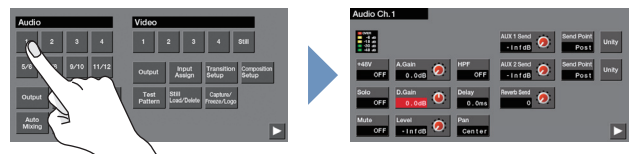

- If the screen extends across multiple pages, touch ◀ or ▶ in the lower part of the screen to switch pages.
- Pressing the [EXIT] button moves you back one level higher.

3. Touch the screen to select the menu item that you want to edit, and edit the value.

- For menu items shown with a red background, use the [VALUE] knob to edit the value.



- By holding down the [ENTER] button and turning the [VALUE] knob, you can change the value more greatly.
- By holding down the [ENTER] button and pressing the [EXIT] button, you can reset the selected menu item (whose background is red) to its default value. If you continue holding the buttons, all menu items in the same screen will return to their default values.

- If the value of the setting is indicated by a button, touch a button to select the value of the setting.

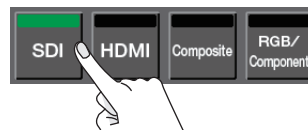

- For some menu items, the value of the setting changes each time you touch it.

4. Press the [MENU] button to close the menu screen.

MEMO

- **Saving your settings**
The contents of the menu settings are saved to the unit (Last Memory) when ten seconds elapse without any operation being performed, or when you close the menu screen.
- The [SELECT] buttons and [SOURCE] buttons are shortcut buttons that access specific menu screens.

Switching the Monitor View Modes

This unit's monitor provides four different view modes. Switch between these views as appropriate for your needs.

1. Press one of the [MULTI-VIEW], [INPUT], [STILL] or [PGM] buttons.

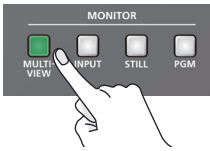

The selected button is lit, and the monitor view mode is switched.

[MULTI-VIEW] button (multi-view mode)

Shows a list of the input/output video and the loaded still images.



1 PVW (preview) video

Shows the video processed up to video compositing. This lets you check the result of video compositing before sending it to program output.

* The freeze (p. 17), user logo (p. 17), and fade-in/out effects (p. 16) are not reflected here.

2 PGM (program) video

Shows the program output video.

3 Input videos

Shows the input videos.

A red border (tally border) is shown on the video that is being output as the program.

4 Still images

Shows the loaded still images.

A light blue border is shown on the still image that is assigned to the VIDEO INPUT SELECT [STILL] button.

A red border (tally border) is shown on the still image that is being output as the program.

MEMO

- You can specify the video compositing result that is output for preview (layer: p. 18). To make this setting, use the [MENU] button → Video <Composition Setup> → "Preview."
- You can change the label names that are shown in the monitor. For details, refer to "Renaming the Monitor Label" (p. 35).

[INPUT] button (input mode)

Shows the input videos in four quarters of the screen.

A red border (tally border) is shown on the video that is being output as the program.

The currently selected video source (connector name) and format are indicated as icons.

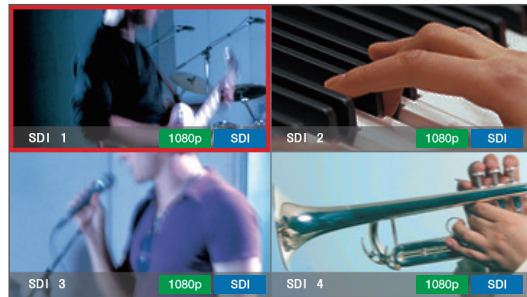

[STILL] button (still image mode)

Shows the loaded still images in four quarters of the screen.

A light blue border is shown on the still image that is assigned to the VIDEO INPUT SELECT [STILL] button.

A red border (tally border) is shown on the still image that is being output as the program.

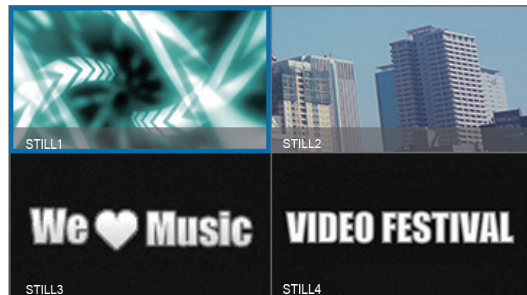

[PGM] button (PGM mode)

Shows the program output video.



Video Input/Output Settings

List of Compatible Video Formats

Input formats

Video signal (connector name)	Frame rate	
	When set to "59.94Hz"	When set to "50Hz"
HDMI (HDMI IN connectors)	480/59.94i	576/50i
	480/59.94p	576/50p
	720/59.94p	720/50p
	1080/59.94i	1080/50i
	1080/59.94p	1080/50p
	1024 x 768/60Hz	1024 x 768/60Hz
	1280 x 720/60Hz	1280 x 720/60Hz
	1280 x 800/60Hz	1280 x 800/60Hz
	1280 x 1024/60Hz	1280 x 1024/60Hz
	1400 x 1050/60Hz	1400 x 1050/60Hz
	1920 x 1080/60Hz	1920 x 1080/60Hz
SDI (SDI IN connectors)	480/59.94i	576/50i
	720/59.94p	720/50p
	1080/59.94i	1080/50i
	1080/59.94p	1080/50p
Composite (COMPOSITE IN connectors)	NTSC (480i)	PAL (576i)
Component (RGB/COMPONENT IN connectors)	480/59.94i	576/50i
	480/59.94p	576/50p
	720/59.94p	720/50p
	1080/59.94i	1080/50i
	1080/59.94p	1080/50p
RGB (RGB/COMPONENT IN connectors)	1024 x 768/60Hz	1024 x 768/60Hz
	1280 x 720/60Hz	1280 x 720/60Hz
	1280 x 800/60Hz	1280 x 800/60Hz
	1280 x 1024/60Hz	1280 x 1024/60Hz
	1400 x 1050/60Hz	1400 x 1050/60Hz
	1920 x 1080/60Hz	1920 x 1080/60Hz

* The input format is detected automatically.

● Audio format

SDI IN connectors	Linear PCM, 24 bits, 48 kHz, 2 ch
HDMI IN connectors	Linear PCM, 24 bits, 48 kHz, 2 ch

Output formats

Video signal (connector name)	Frame rate		
	When set to "59.94Hz"	When set to "50Hz"	
HDMI (HDMI OUT PGM, AUX connectors)	480/59.94i	576/50i	
	480/59.94p	576/50p	
	720/59.94p	720/50p	
	1080/59.94i	1080/50i	
	1080/59.94p	1080/50p	
	1024 x 768/60Hz	1024 x 768/75Hz	
	1280 x 720/60Hz	1280 x 720/60Hz	
	1280 x 800/60Hz	1280 x 800/75Hz	
	1280 x 1024/60Hz	1280 x 1024/75Hz	
	1400 x 1050/60Hz	1400 x 1050/60Hz	
	1920 x 1080/60Hz	1920 x 1080/60Hz	
	HDMI (HDMI OUT MULTI-VIEW connector)	1080/60p	1080/60p
	SDI (SDI OUT connectors)	480/59.94i	576/50i
		720/59.94p	720/50p
1080/59.94i		1080/50i	
1080/59.94p		1080/50p	
Component (RGB/COMPONENT OUT connectors)	480/59.94i	576/50i	
	480/59.94p	576/50p	
	720/59.94p	720/50p	
	1080/59.94i	1080/50i	
	1080/59.94p	1080/50p	
RGB (RGB/COMPONENT OUT connectors)	1024 x 768/60Hz	1024 x 768/75Hz	
	1280 x 720/60Hz	1280 x 720/60Hz	
	1280 x 800/60Hz	1280 x 800/75Hz	
	1280 x 1024/60Hz	1280 x 1024/75Hz	
	1400 x 1050/60Hz	1400 x 1050/60Hz	
	1920 x 1080/60Hz	1920 x 1080/60Hz	
USB-VIDEO (USB STREAMING port)	When set to "59.94Hz"	When set to "50Hz"	
	480/59.94p	576/50p	
	720/59.94p	720/50p	
	1080/59.94p	1080/50p	
	When set to "29.94Hz"	When set to "25Hz"	
	480/29.97p	576/25p	
	720/29.97p	720/25p	
	1080/29.97p	1080/25p	

* The output format of the MULTI-VIEW connector is fixed at 1080/60p.

● Audio formats

SDI OUT connectors	Linear PCM, 24 bits, 48 kHz, 2 ch
HDMI OUT connectors	Linear PCM, 24 bits, 48 kHz, 2 ch
USB STREAMING port	Linear PCM, 16 bits, 48 kHz, 2 ch

About frame rate

The frame rates "59.94 Hz" and "50 Hz" are supported for input and output video (excepting USB output). To make this setting, use the [MENU] button → System <Setup> → "Frame Rate."

For USB output video, the frame rates "59.94 Hz" and "29.97 Hz" or "50 Hz" and "25 Hz" are supported. To make this setting, use the [MENU] button → System <USB Streaming> → "Frame Rate."

Setting the Output Format

Here's how to specify the output format as appropriate for the device that's connected.

1. Press the [MENU] button → touch Video <Output>.

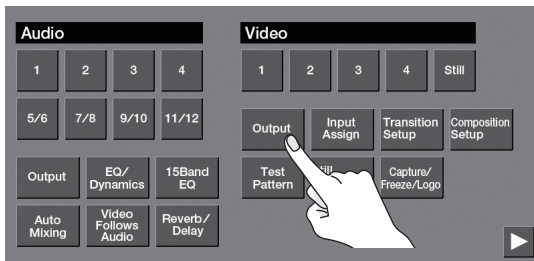

2. Touch <Format>.

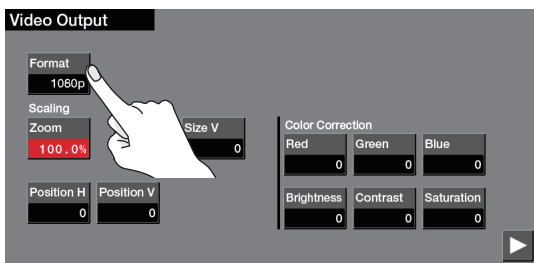

3. Touch a button to select the output format.

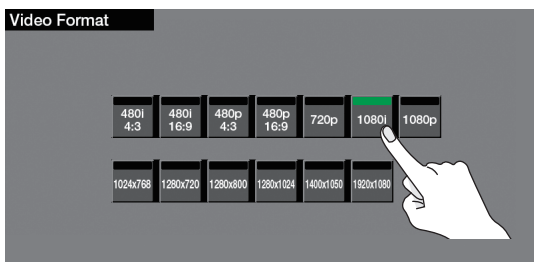

The output format switches.

4. Press the [MENU] button to close the menu screen.

MEMO

- If the output format is set to "1024 x 768"–"1920 x 1080," video is not output from the SDI OUT (PGM, AUX) connectors.
- The output format of the MULTI-VIEW connector is fixed at 1080/60p.
- The output format of the USB STREAM port can be set by the [MENU] button → System <USB Stream> → "Resolution" (p. 32).

Assigning Video Sources

Here's how to assign the video sources being input from the video input connectors to the VIDEO INPUT SELECT [1]–[4] buttons.

1. Press the [INPUT ASSIGN] button.

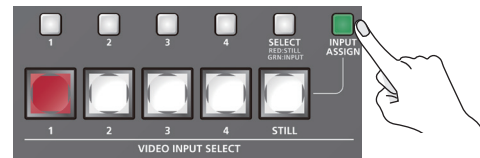

The [INPUT ASSIGN] button is lit, and the video source select screen appears.

2. Touch a button to select the video source (connector name) that you want to input to Video Input 1–4.

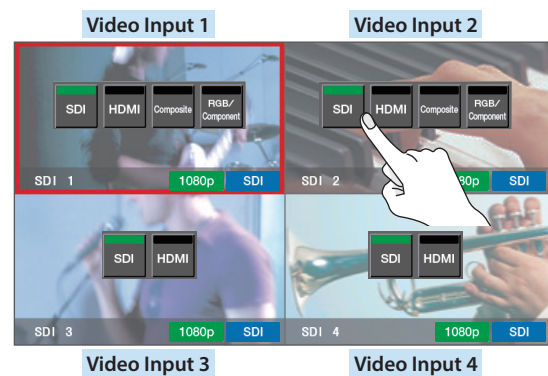

3. Press the [INPUT ASSIGN] button to close the screen.

MEMO

You can also select the video source by pressing the [SELECT] button several times to make it light green, and then using the STILL/INPUT SOURCE [1]–[4] buttons.

The lit color of the button indicates the video source.

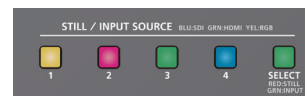

Lit color	Video source
Blue	SDI IN
Green	HDMI IN
Magenta	COMPOSITE IN
Yellow	RGB/COMPONENT IN

Inputting Copy-Protected (HDCP) Video

If you want to input HDCP-protected video from a BD player or other device, you can enable HDCP input.

* If you want to output copy-protected (HDCP) video or audio, connect a device that supports HDCP.

What's HDCP?

HDCP is copyright-protection technology that prevents unlawful copying of content by encoding the path when sending digital signals from a video playback device to a display monitor or other display equipment.

1. Press the [MENU] button → touch <▶> → System < Setup>.

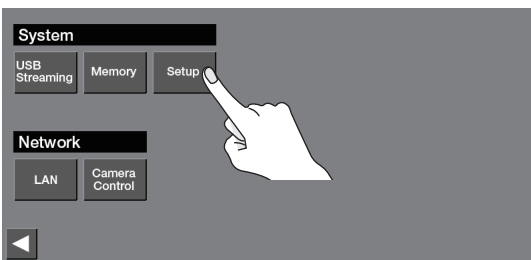

2. Touch <HDCP> to turn it "ON."

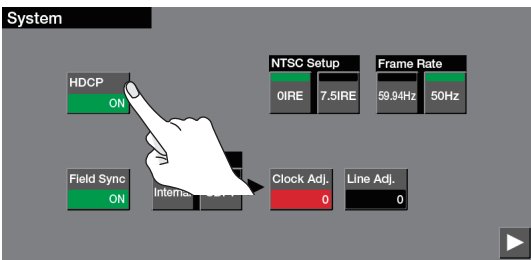

Value	Explanation
ON	HDCP-protected video can be input. HDCP is also added to the video that is output.
OFF	HDCP-protected video cannot be input.

3. Press the [MENU] button to close the menu screen.

Video/audio output restrictions

If "HDCP" is on, restrictions apply to the video/audio output. Video and audio respectively are output only from the following connectors.

Source	Connectors available for output
Video	HDMI OUT (PGM, AUX, MULTI-VIEW) connectors
Audio	HDMI OUT (PGM, AUX, MULTI-VIEW) connectors MAIN jacks AUX 1 jacks AUX 2/MONITOR jacks PHONES jacks

Checking for HDCP-capable devices

Source devices

If "HDCP" is "ON," you can check the source devices for HDCP capability by setting the monitor view to input mode (p. 8). The HDCP icon is shown if HDCP-encrypted video is being input.

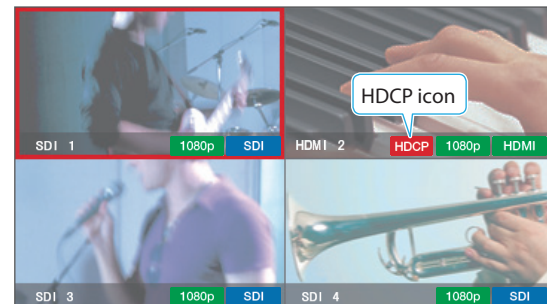

Output devices

The HDCP indicator shows whether the output device is HDCP-capable.



Indicator	"HDCP" setting	Connection status
Lit	ON	An HDCP-capable device is connected to one of the HDMI OUT connectors.
Blinking	ON	An HDCP-capable device is not connected to an HDMI OUT connector. Alternatively, a device that is not HDCP capable is connected to one of the HDMI OUT connectors.
Unlit	OFF	—

Assigning Video Buses to Output Connectors

This unit provides three video buses: PGM, PVW, and AUX. You can assign the video bus of your choice to each of the PGM and AUX connectors.

PGM bus	Outputs the video that reflects all processing such as video compositing that has been applied (the program video).
PVW bus	Outputs the video that has been processed up to video compositing (the preview video). * The freeze (p. 17), user logo (p. 17), and fade-in/out effects (p. 16) are not reflected here.
AUX bus	Outputs the video of your choice sent to the AUX bus. This lets you allocate a separate output that is independent of the program output, such as when you want a specific input video to be a fixed output.

1. Press the [MENU] button → touch Video <Output>.

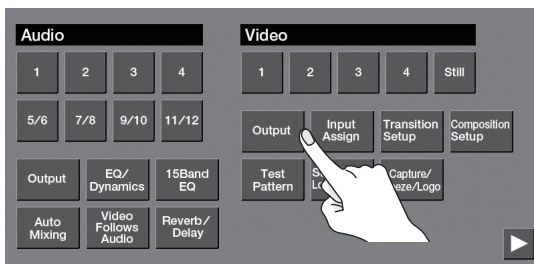

2. <▶> → touch Output Bus <PGM>, <PVW>, or <AUX> to select the video bus that you want to assign to each connector.

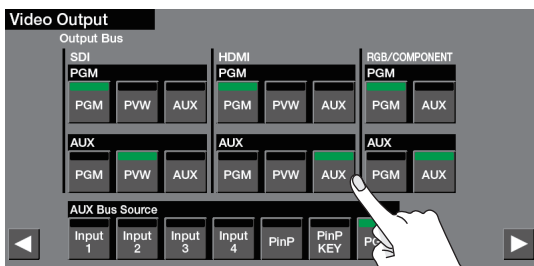

3. Press the [MENU] button to close the menu screen.

MEMO

For details on video switching for the PGM bus and PVW bus, refer to “Switching the Video” (p. 13).

Selecting the Video Sent to the AUX Bus

1. Press one of the AUX [1]–[PGM] buttons to select the video that is sent to the AUX bus.

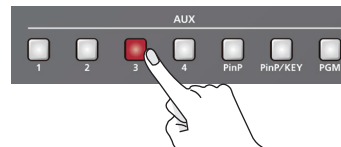

Button	Explanation
[1]–[4]	Video being input to Video Input 1–4
[PinP]	Source video of the PinP layer (p. 19)
[PinP/KEY]	Source video of the PinP/KEY layer (p. 20–22)
[PGM]	Program video

The video is switched for the output connector to which the AUX bus is assigned.

MEMO

The video of the AUX bus can also be changed by [MENU] button → Video <Output> → <▶> → “AUX Bus Source.”



Video Operations

Switching the Video

Here's how to switch between the Video input 1–4 video signals.

1. In advance, assign the video sources as described in "Assigning Video Sources" (p. 10).
2. Press one of the [CUT], [MIX], or [WIPE] button to select the transition effect.



Transition effect	Explanation
Cut	The video switches instantly. 
Mix	The two videos are mixed as the transition occurs. 
Wipe	The next video moves across to replace the original video. 

3. If you selected mix or wipe in step 2, turn the [TIME] knob to specify the video transition time.



4. Press a VIDEO INPUT SELECT [1]–[4] button to select the video.

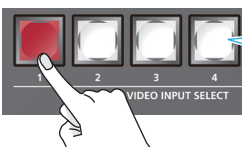

Button	Video status
Lit red	Video is being output.
Blinking red	Video is transitioning.

The video is switched.

If the monitor view (p. 8) is multi-view or input mode, a red border (tally border) is shown on the program output video.

MEMO

- You can change the wipe transition pattern or the wipe direction. To do so, press the [MENU] button → Video <Transition Setup> → "Wipe Pattern" or "Direction."
- If the monitor view is multi-view or input mode, you can switch the video by touching an input video in the screen.

Outputting a Loaded Still Image

A still image loaded into this unit can be assigned to the VIDEO INPUT SELECT [STILL] button, and output in the same way as video.

1. In advance, load a still image into this unit as described by the following procedures.
 - ➔ "Capturing a Still Image from Output Video" (p. 14)
 - ➔ "Loading a Still Image from a USB Flash Drive" (p. 15)
2. Press the [SELECT] button several times to make it light red.

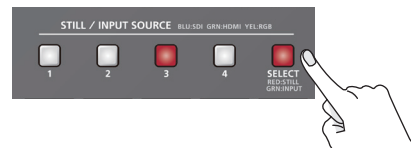

3. Press one of the STILL/INPUT SOURCE [1]–[4] buttons to select the still image that you want to assign to the [STILL] button.

The currently selected button is lit red.

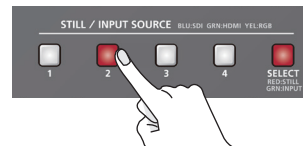

By setting the monitor view (p. 8) to multi-view or still image mode, you can check the still images that are loaded into this unit. A light blue border is shown on the currently selected still image.

4. Press the [STILL] button.

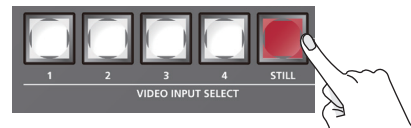

The [STILL] button lights, and the still image is output.

If the monitor view (p. 8) is multi-view or still image mode, a red border (tally border) is shown on the still image that is being output as the program.

MEMO

If the monitor view is multi-view or still image mode, you can switch output by touching a still image in the screen.

Loading a Still Image

You can load a still image, and output it in the same way as video (p. 13) or use it as a source for key compositing (p. 21) or a user logo (p. 17). There are two ways to load a still image: you can capture from output video, or you can load from a USB flash drive.

Capturing a Still Image from Output Video

Here's how to capture a still image from the output video.

NOTE

Up to four still images can be temporarily saved in the unit. When you turn off the power, the still images are deleted.

1. Press the [MENU] button → touch Video <Capture/Freeze/Logo>.

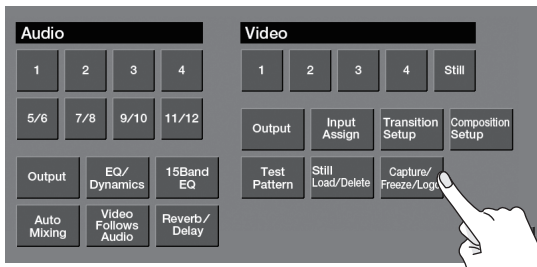

2. Touch Source <PGM> or <AUX> and specify the video from which you want to capture.

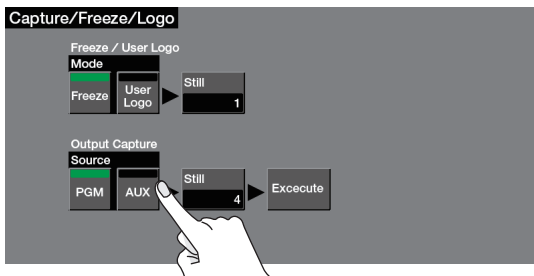

Value	Explanation
PGM	PGM bus video
AUX	AUX bus video

3. Touch Output Capture <Still>.

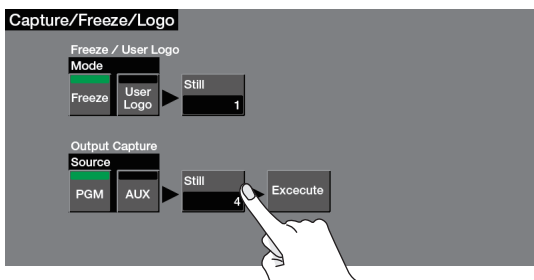

4. Touch a box to specify the save-destination for the still image.

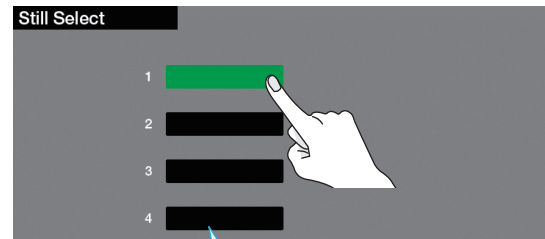

Boxes in which a still image is saved show the file name of the still image.

5. Press the [EXIT] button to return to the previous menu screen.
6. According to the still image that you want to capture, touch <Execute>.

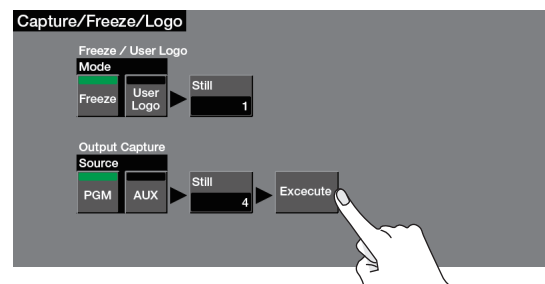

The capture is executed.

7. Press the [MENU] button to close the menu screen.

MEMO

- It may take some time for the capture to be completed.
- If you capture when HDCP (p. 11) is on, the still image that is created is handled in the same way as HDP-protected video. It cannot be used if HDCP is off.
- You can't save the captured still image to the USB flash drive.

Loading a Still Image from a USB Flash Drive

Here's how to load a still image from a USB flash drive into the unit.

NOTE

- Up to four still images can be temporarily saved in the unit. When you turn off the power, the still images are deleted.
- Still images cannot be scaled. In advance, you must prepare still images of the resolution that is appropriate for your output format.
- When using a USB flash drive for the first time, you must format it using this unit (p. 35).
- Never turn off the power or remove the USB flash drive while the message "Processing." is shown.
- Depending on the USB flash drive, recognition of the flash drive might take some time.

Formats supported for loading

Format	Windows Bitmap file (.bmp), 24-bit color, uncompressed
Resolution	Maximum 1920 x 1080 pixels
File name	Up to eight single-byte alphanumeric characters * The extension ".bmp" must be added.

Loading a still image

1. Save the still image in the root directory of the USB flash drive.
2. Connect the USB flash drive containing the still image to the USB MEMORY port.
3. Press the [MENU] button → touch Video <Still Load/Delete>.

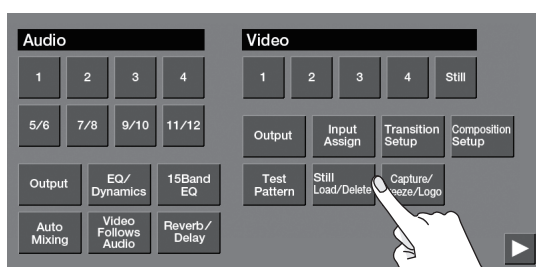

4. Touch a box to specify the save-destination for the still image.

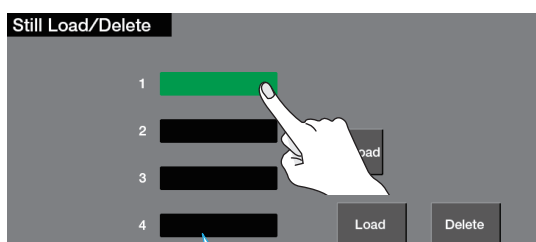

Boxes in which a still image is saved show the file name of the still image.

5. Touch <Load>.

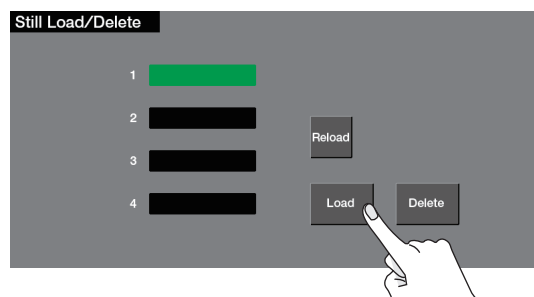

6. Touch the still image that you want to load.

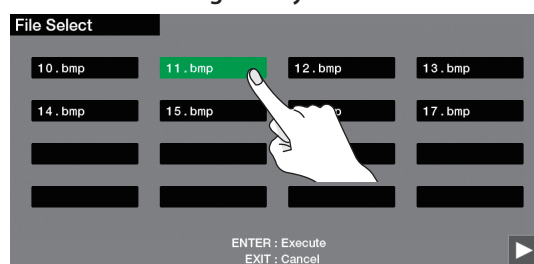

If you want to cancel the operation, press the [EXIT] button.

7. Press the [ENTER] button.

The still image is loaded into the unit.

8. Press the [MENU] button to close the menu screen.

MEMO

- If the file size of the still image is large, it may take some time for it to load.
- You can make the previously-loaded still image be automatically loaded at startup. Save the same file in the root directory of the USB flash drive, and start this unit with the USB flash drive connected.
If the still image would not be loaded correctly, try reloading it from the USB flash drive. Press the [MENU] button → touch Video <Still Load/Delete> → <Reload>.
- To delete a still image, press the [MENU] button → touch Video <Still Load/Delete> → select the still image that you want to delete → touch <Delete>.

Switching the Video Automatically (Video Follows Audio)

This detects the audio that is input from a mic, and automatically switches to the specified video according to the volume (Video Follows Audio function).

For example, if you're streaming a talk show or a conversation, you can use this to switch between a closeup of the individual who is speaking and a wide shot of both people when neither person is speaking.

1. Press the [MENU] button → touch Audio <Video Follows Audio>.

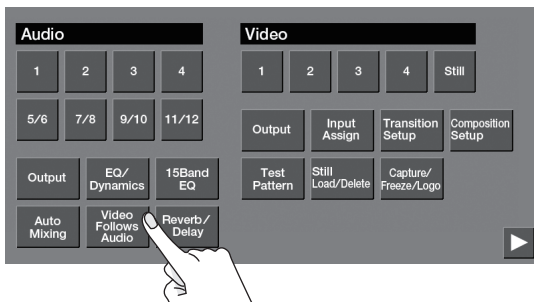

2. Touch a menu item, and edit its setting.

Switch pages, and set the necessary menu items.

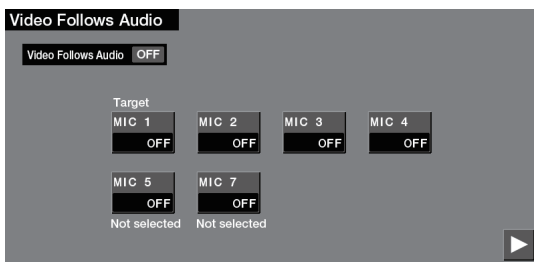

Menu item	Explanation
Target	Specifies the video that is output when audio is detected.
Threshold	Specifies the reference level at which the Video Follows Audio function operates. When audio that exceeds this threshold is detected, the video is switched.
Mix	Specifies the video that is output when audio is detected in multiple mics. If this is "OFF," video is switched in the order in which audio is detected.
Silent	Specifies the video that is output when there is no audio input from any mic. If this is "OFF," the last-selected video continues to be output.
Time	Specifies the time after the video has switched until audio detection resumes.

3. Touch <Video Follows Audio> to turn it "ON."

The video follow audio function turns on.

4. Press the [MENU] button to close the menu screen.

MEMO

- The "MIC 5" and "MIC 7" settings are valid only if the audio sources of channels 5/6 and 7/8 (p. 24) are respectively mics.
- This function does not operate simultaneously with the Audio Follows function (p. 27). If this function is turned on, the Audio Follows function automatically turns off.

Fading-In/Out the Program Output Video

Here's how to perform a fade-out from the program output video to a black screen, or a fade-in from a black screen to the program output video.

A scene that you don't want to output as video can be changed to a black screen.

- * A fade-in/out effect can be applied only if mix or wipe is selected as the transition effect.

1. Press the [OUTPUT FADE] button.

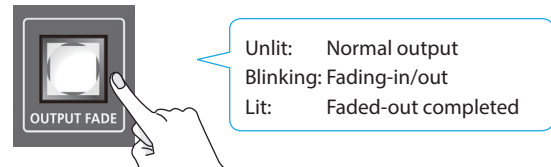

The program output video fades-out to a black screen.

When fade-out is complete, the [OUTPUT FADE] button is lit.

2. To fade-in, press the [OUTPUT FADE] button once again.

The [OUTPUT FADE] button blinks, and program output begins.

When fade-in is complete, the [OUTPUT FADE] button goes dark.

MEMO

- You can also fade-in/out to a white screen. Use the [MENU] button → System <Setup> → <▶> → and set Output Fade "Color" to "White."
- The time required for fade-in/out is determined by the setting of the [TIME] knob.

Freezing the Program Output Video (Freeze)

You can temporarily freeze the program output video (freeze function).

1. Press the [MENU] button → touch <Capture/Freeze/Logo>.

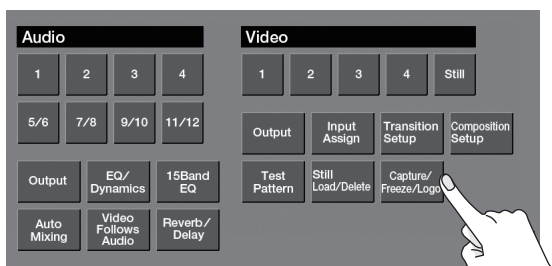

2. Touch Mode <Freeze> to specify the operating mode of the [FREEZE/USER LOGO] button.

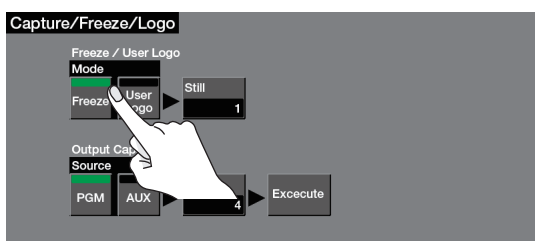

3. Press the [MENU] button to close the menu screen.
4. Press the [FREEZE/USER LOGO] button to turn freeze on (lit).



The program output video freezes.

5. To turn off freeze, press the [FREEZE/USER LOGO] button once again.

The [FREEZE/USER LOGO] button goes dark, and normal output resumes.

Inserting a Still Image in the Program Output (User Logo)

You can pause the program output, and output a still image of your choice.

This is convenient when you want to output a user logo (such as the logo of a company or a product name).

1. In advance, load a still image into this unit as described by the following procedures.

- "Capturing a Still Image from Output Video" (p. 14)
- "Loading a Still Image from a USB Flash Drive" (p. 15)

2. Press the [MENU] button → touch <Capture/Freeze/Logo>.

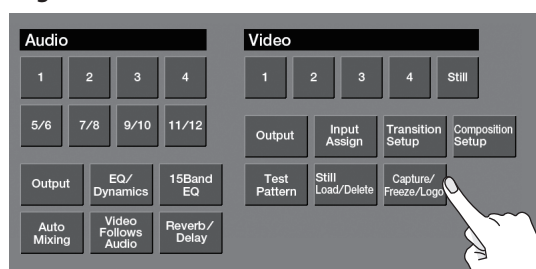

3. Touch Mode <User Logo> to specify the operating mode of the [FREEZE/USER LOGO] button.

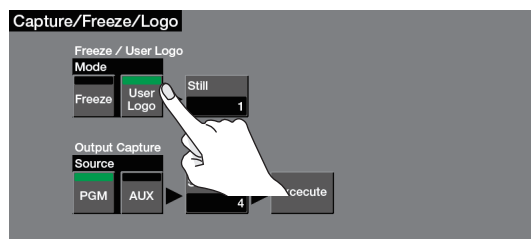

4. Touch Freeze/User Logo <Still>.

5. Touch a box to select the still image that you want to assign to the [FREEZE/USER LOGO] button.

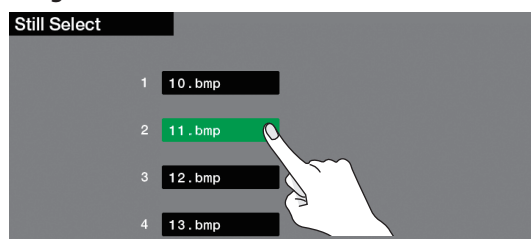

6. Press the [MENU] button to close the menu screen.
7. Press the [FREEZE/USER LOGO] button to make it light.



The user logo is output via a cut.

8. To return to normal output, press the [FREEZE/USER LOGO] button once again to make it go dark.

The normal output resumes via a cut.

Video Composition Operations

About the Video Compositing Layer Hierarchy

A video composited screen is created by a stack of layers. This unit lets you composite video by stacking up to three layers. The compositing effects available are fixed for each layer.

Composition effect	Explanation
Picture-in-picutre (PinP)	The inset screen (a separate small screen) is shown on top of the background video.
Luminance key	A portion of the video is made transparent, and composited with the background video. You can use luminance key with either a black or a white background, or a chroma key with either a blue or green background.
Chroma key	

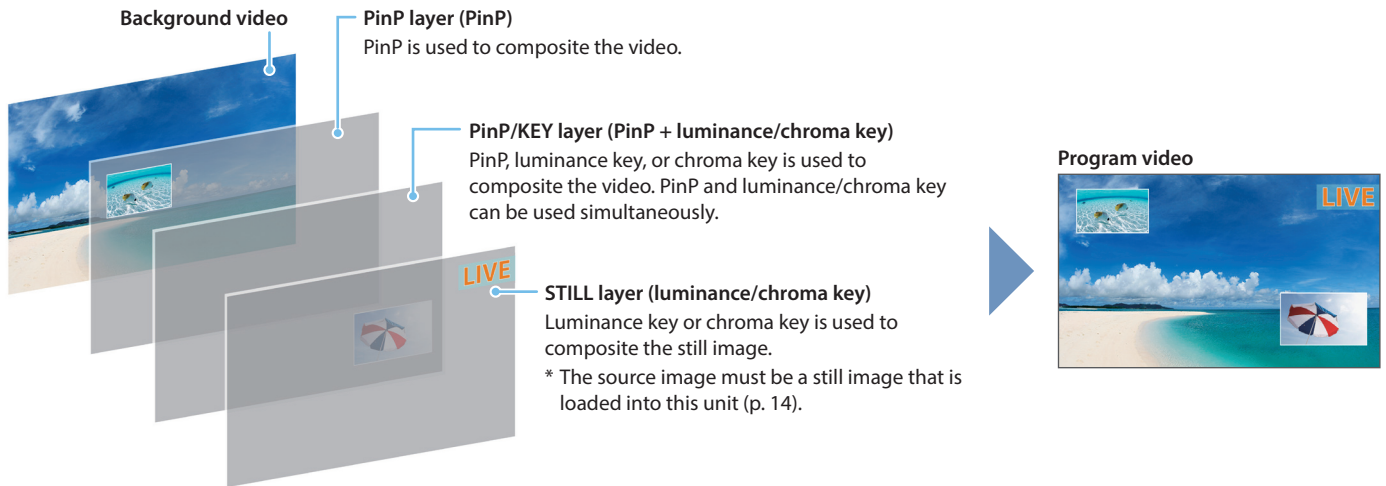

Changing the order of layers

1. Press the [MENU] button → touch Video <Composition Setup>.

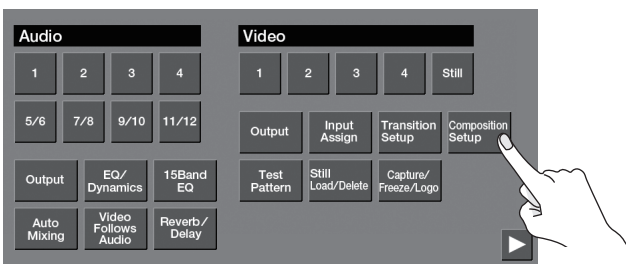

2. Touch <Layer>.



3. Touch the button of the layer that you want to show at the foreground, specifying it as "Top."

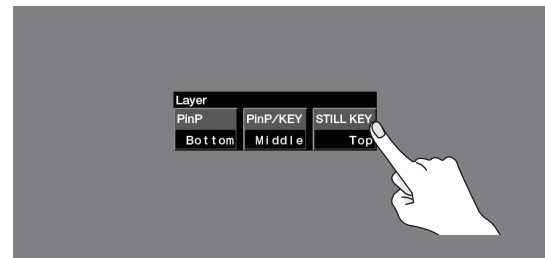

4. Touch the button of the layer that is specified as "Top," and specify the stacking order of layers other than the Top layer.

Each time you press the button, the "Middle" and "Bottom" layers alternate.

5. Press the [MENU] button to close the menu screen.

Compositing Using Picture-in-Picture (PinP)

Here's how to composite an inset screen (a small separate screen) onto the background video.



1. Press one of the VIDEO INPUT SELECT [1]–[4] buttons to select the background video.

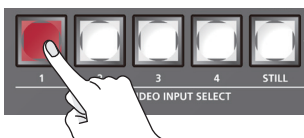

2. Press the PinP [SOURCE] button to access the PinP Source screen.

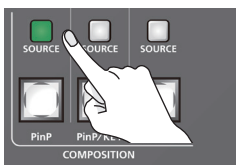

3. Touch Source <SDI 1>–<HDMI 4> to select the inset screen video.



4. Press the [EXIT] button to return to the previous menu screen.

5. While holding your finger on the inset screen, slide to adjust its position.

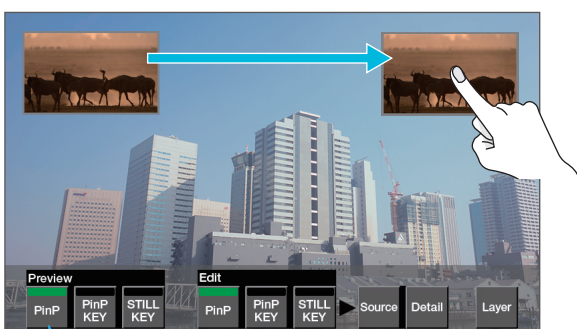

Select the layer to preview.

6. Use the [VALUE] knob to adjust the size of the inset screen.



7. Press the [MENU] button to close the menu screen.

8. Press the [PinP] button.

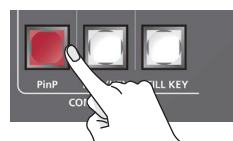

The [PinP] button is lit red, and the composited result is sent from program output.

Each time you press the [PinP] button, the inset screen alternates between visible and hidden.

MEMO

If mix or wipe are selected as the video transition effect, the setting of the [TIME] knob specifies the time over which the inset screen appears or disappears.

Making detailed settings for the inset screen

You can press the PinP [SOURCE] button → <Detail> to make detailed settings for the inset screen.

Menu item	Explanation
Size	Adjusts the size (zoom).
Position H	Adjusts the horizontal position.
Position V	Adjusts the vertical position.
Cropping	Specifies the cropping type.
Size H (*1)	Adjusts the horizontal size when cropped.
Size V (*1)	Adjusts the vertical size when cropped.
View	Use the following items to adjust the video that is shown in the inset screen.
Zoom	Adjusts the zoom.
Position H	Adjusts the horizontal position.
Position V	Adjusts the vertical position.
Border	Use the following items to adjust the border that is added to the inset screen.
Red	Adjusts the red level of the border color.
Green	Adjusts the green level of the border color.
Blue	Adjusts the blue level of the border color.
Width	Adjusts the width of the border.

(*1) This is valid if "Cropping" is set to "Manual."

Compositing Two Inset Screens

By using PinP compositing on the PinP/KEY layer, you can show two inset screens beside each other.



1. Composite the video as described in “Compositing Using Picture-in-Picture (PinP)” (p. 19).
2. Press the PinP/KEY [SOURCE] button to access the PinP/KEY Source screen.

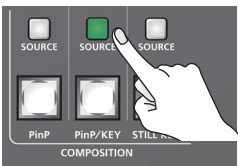

3. Touch Source <SDI 1>-<HDMI 4> to select the inset screen video.

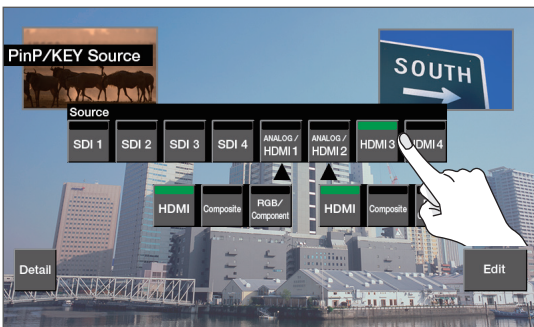

4. Press the [EXIT] button to return to the previous menu screen.
5. While holding your finger on the inset screen, slide to adjust its position.

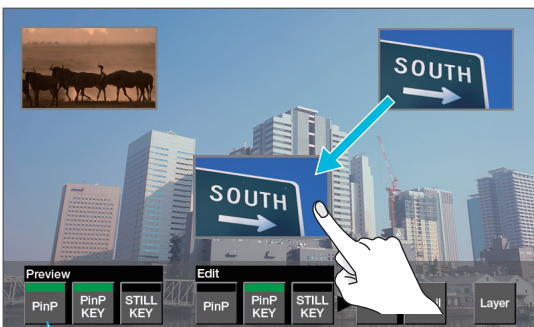

Select the layer to preview.

6. Use the [VALUE] knob to adjust the size of the inset screen.



7. Press the [MENU] button to close the menu screen.
8. Press the [PinP/KEY].

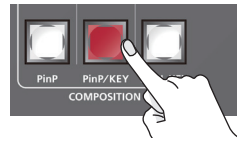

The [PinP/KEY] button is lit red, and the composited result is sent from program output.

Each time you press the [PinP/KEY] button, the inset screen alternates between visible and hidden.

MEMO

- In the PinP/KEY layer, PinP and key compositing both work. For details on key compositing, refer to the following.
 - “Compositing a Logo or Image (Luminance Key)” (p. 21)
 - “Compositing a Subject and Background (Chroma Key)” (p. 22)

If you want to use only PinP compositing, disable the key compositing setting.

Use the PinP/KEY [SOURCE] button → <Detail> → <▶> → and set “KEY” to “OFF.”

- If mix or wipe are selected as the video transition effect, the setting of the [TIME] knob specifies the time over which the inset screen appears or disappears.

Making detailed settings for the inset screen

You can press the PinP/KEY [SOURCE] button → touch <Detail> to make detailed settings for the inset screen.

Menu item	Explanation
Size	Adjusts the size (zoom).
Position H	Adjusts the horizontal position.
Position V	Adjusts the vertical position.
Cropping	Specifies the cropping type.
Size H (*1)	Adjusts the horizontal size when cropped.
Size V (*1)	Adjusts the vertical size when cropped.
View	Use the following items to adjust the video that is shown in the inset screen.
Zoom	Adjusts the zoom.
Position H	Adjusts the horizontal position.
Position V	Adjusts the vertical position.
Border	Use the following items to adjust the border that is added to the inset screen.
Red	Adjusts the red level of the border color.
Green	Adjusts the green level of the border color.
Blue	Adjusts the blue level of the border color.
Width	Adjusts the width of the border.

(*1) This is valid if “Cropping” is set to “Manual.”

Compositing Using Key

Here's how you can turn a portion of the video transparent and composite it with the background video. You can use luminance key with either a black or a white background, or a chroma key with either a blue or green background.

Compositing a Logo or Image (Luminance Key)

You can cut out a logo or image by turning its black or white portion transparent, and then superimpose it on the background video.



1. Press one of the VIDEO INPUT SELECT [1]–[4] buttons to select the background video.

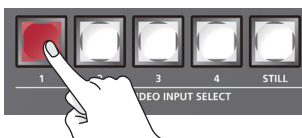

2. Press the PinP/KEY [SOURCE] button to access the PinP/KEY Source screen.

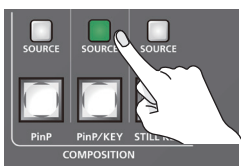

3. Touch Source <SDI 1>–<HDMI 4> to select the source of a logo or image.

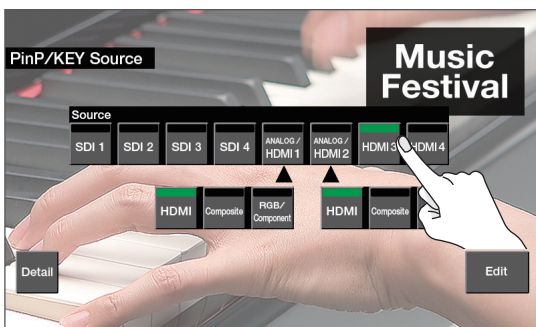

4. Touch <Detail> → <▶> → Type <Lumi White> or <Lumi Black> to select the key type.

Value	Explanation
Lumi White	Makes white portions transparent according to brightness.
Lumi Black	Makes black portions transparent according to brightness.

5. Press the [EXIT] button to return to the previous menu screen.

6. Use the PinP/KEY [KEY LEVEL] knob to adjust the degree of key removal.

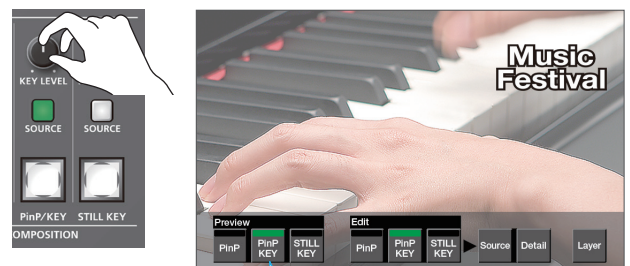

Select the layer to preview.

7. Press the [MENU] button to close the menu screen.
8. Press the [PinP/KEY] button.

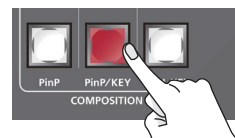

The [PinP/KEY] button is lit red, and the composited result is sent from program output.

Each time you press the [PinP/KEY] button, the logo or image alternates between visible and hidden.

MEMO

- In the PinP/KEY layer, PinP and key compositing both work. For details on PinP compositing settings, refer to "Compositing Two Inset Screens" (p. 20).
If you want to use only key compositing, disable the PinP compositing setting.
Use the PinP/KEY [SOURCE] button → <Detail> → and set "PinP" to "OFF".
- If mix or wipe are selected as the video transition effect, the setting of the [TIME] knob specifies the time over which the logo or image appears or disappears.

Compositing a Subject and Background (Chroma Key)

You can cut out a video by turning its blue or green portion transparent, and then superimpose it on the background video. This lets you composite a subject that's photographed against a blue background or green background.

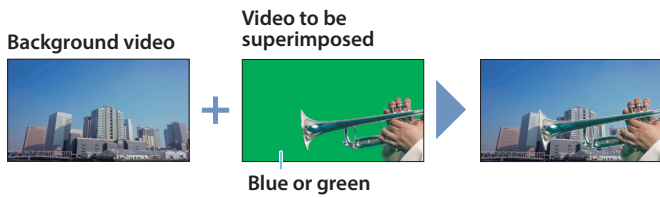

1. Press one of the VIDEO INPUT SELECT [1]–[4] buttons to select the background video.

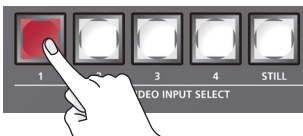

2. Press the PinP/KEY [SOURCE] button to access the PinP/KEY Source screen.

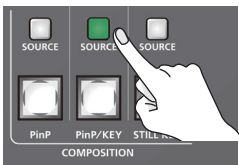

3. Touch Source <SDI 1>–<HDMI 4> to select the source video that you want to superimpose.

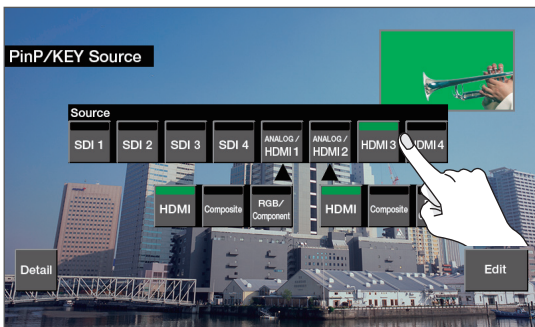

4. Touch <Detail> → <▶> → Type <Chroma Blue> or <Chroma Green> to select the key type.

Value	Explanation
Chroma Blue	Uses a color threshold to make blue transparent.
Chroma Green	Uses a color threshold to make green transparent.

5. Press the [EXIT] button to return to the previous menu screen.

6. Use the PinP/KEY [KEY LEVEL] knob to adjust the degree of key removal.

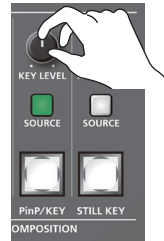

Select the layer to preview.

7. Press the [MENU] button to close the menu screen.

8. Press the [PinP/KEY] button.

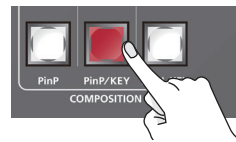

The [PinP/KEY] button is lit red, and the composited result is sent from program output.

Each time you press the [PinP/KEY] button, the superimposed video alternates between visible and hidden.

MEMO

- In the PinP/KEY layer, PinP and key compositing both work. For details on PinP compositing settings, refer to “Compositing Two Inset Screens” (p. 20).
If you want to use only key compositing, disable the PinP compositing setting.
Use the PinP/KEY [SOURCE] button → <Detail> → and set “PinP” to “OFF.”
- If mix or wipe are selected as the video transition effect, the setting of the [TIME] knob specifies the time over which the superimposed video appears or disappears.

Finely adjusting the key color (removed color)

You can press the PinP/KEY [SOURCE] button → touch <Detail> → <▶> to make fine adjustments to the key color.

Menu item	Explanation	
Hue	Width	Adjusts the hue width.
	Fine	Adjusts the center position of the hue.
Saturation	Width	Adjusts the saturation width.
	Fine	Adjusts the center position of saturation.

Compositing a Still Image Loaded into the Unit (Luminance/Chroma Key)

A portion of a still image loaded into this unit can be made transparent, and composited with the background video.

* The still image assigned to the VIDEO INPUT SELECT [STILL] button is used as the source image.

Luminance key



Chroma key

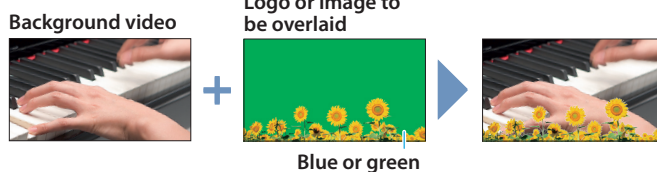

1. In advance, load a still image into this unit as described by the following procedures.

- “Capturing a Still Image from Output Video” (p. 14)
- “Loading a Still Image from a USB Flash Drive” (p. 15)

2. Press one of the VIDEO INPUT SELECT [1]–[4] buttons to select the background video.

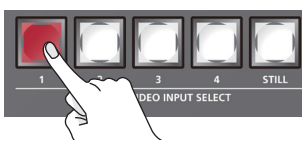

3. Press the STILL KEY [SOURCE] button to access the STILL KEY Source screen.

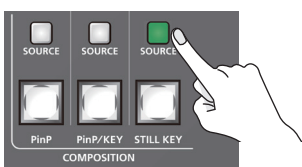

4. In the <Still> → Still Select screen, touch the source image to select it, and press the [ENTER] button.



* You can also select the source image by [SELECT] button (lit red) → STILL/INPUT SOURCE [1]–[4] button.

5. In the <Detail> → Still KEY screen, touch the “Type” button to select the key type.

Value	Explanation
Lumi White	Makes white portions transparent according to brightness.
Lumi Black	Makes black portions transparent according to brightness.
Chroma Blue	Uses a color threshold to make blue transparent.
Chroma Green	Uses a color threshold to make green transparent.

6. Press the [EXIT] button to return to the previous menu screen.

7. Use the STILL KEY [KEY LEVEL] knob to adjust the degree of key removal.



8. Press the [MENU] button to close the menu screen.

9. Press the [STILL KEY] button.

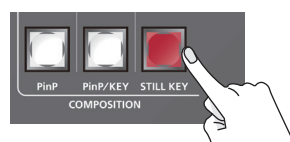

The [STILL KEY] button is lit red, and the composited result is sent from program output.

Each time you press the [STILL KEY] button, the logo or image alternates between visible and hidden.

MEMO

- If mix or wipe are selected as the video transition effect, the setting of the [TIME] knob specifies the time over which the logo or image appears or disappears.
- When using chroma key compositing, you can use STILL KEY [SOURCE] button → <Detail> to make fine adjustments to the key color.

Menu item		Explanation
Hue	Width	Adjusts the hue width.
	Fine	Adjusts the center position of the hue.
Saturation	Width	Adjusts the saturation width.
	Fine	Adjusts the center position of saturation.

Audio Operations

Assigning Audio Sources to Audio Channels

Audio from video input (HDMI, SDI), line input, or mic can be assigned to channels 5/6–11/12.

1. Press the [SELECT] button of the channel whose settings you want to change; the Audio Ch. screen appears.

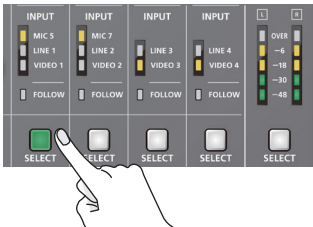

2. Touch Input <MIC>, <LINE>, or <VIDEO> to select an audio source.

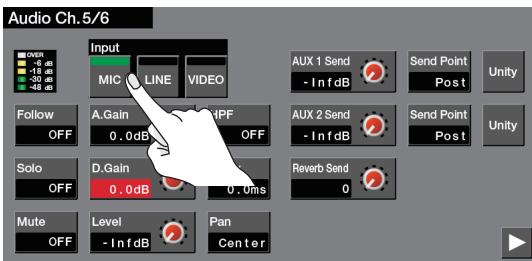

Value	Ch. 5/6	Ch. 7/8	Ch. 9/10	Ch. 11/12
MIC	MIC 5	MIC 7	—	—
LINE	LINE 1	LINE 2	LINE 3	LINE 4
VIDEO (*1)	HDMI IN 1 SDI IN 1	HDMI IN 2 SDI IN 2	HDMI IN 3 SDI IN 3	HDMI IN 4 SDI IN 4

(*1) Channels 1 and 2 of the SDI or HDMI embedded audio channels are input.

3. Press the lit [SELECT] button to close the menu screen.

MEMO

The INPUT indicator shows currently selected audio source.

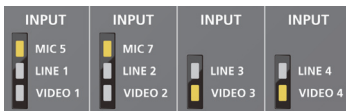

Adjusting the Input Gain (Sensitivity)

Here's how to adjust the input gain so that the audio is at the appropriate level.

Here we explain using the AUDIO IN 1 audio as an example.

NOTE

Turning the [GAIN] knobs may produce a popping noise or cause momentary audio drop-out, but this is not a malfunction.

1. Position the channel 1 audio fader near the "0 dB."

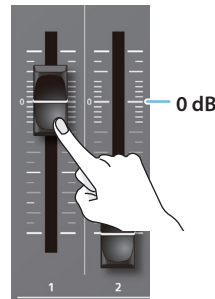

2. Move the [MAIN] fader to a position near the "0 dB."

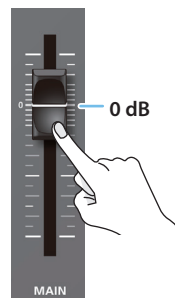

3. Turn the channel 1 [GAIN] knob fully counter-clockwise, minimizing (0 dB) the input gain.



4. While producing the sound that will actually be input, slowly turn the [GAIN] knob clockwise to adjust the input gain.

Raise the input gain as high as possible without allowing the level meter "OVER" indication to light red when the loudest sound level occurs.

MEMO

Adjusting the position (pan)

The left/right positioning of the sound is called "pan." If you're using two mics to stream a performance, panning the two mics to left and right will give the sound a more spacious feel.

This can be adjusted for channels 1–7/8. Press the [SELECT] button of the channel whose setting you want to change → adjust "Pan."

* Channels 5/6 and 7/8 can be specified only if the audio source is a mic.

Adjusting the Volume Balance

Here's how to adjust the volume balance of each input and the overall volume.

1. Move the [MAIN] fader to a position near the "0 dB."

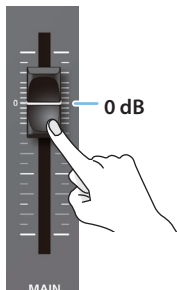

2. While monitoring the audio via speakers or headphones, adjust the volume balance for the respective inputs.

Raise the volume level of audio you want to make more prominent, for example, an emcee microphone, and lower the volume level for other audio. When no audio is input, and for audio that is unused, lower the volume level to minimum (-Inf dB).

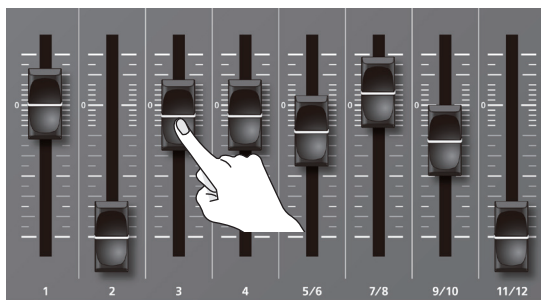

3. Use the [MAIN] fader to adjust the volume of the output.

The MAIN level meter will light yellow at the appropriate volume.

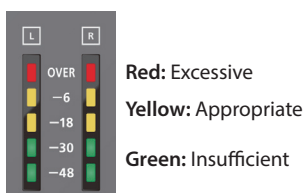

Correcting a Time Difference Between Video and Audio (Delay)

If there is a timing discrepancy between the video and audio, you can correct the output timing by delaying the audio output.

1. Press the [SELECT] button of the channel whose settings you want to change; the Audio Ch. screen appears.

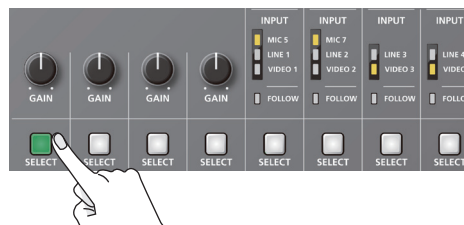

2. Touch <Delay>, and then use the [VALUE] knob to adjust the delay time of the input audio.

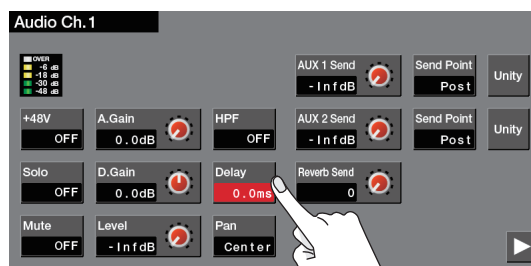

3. Press the lit [SELECT] button to close the menu screen.

MEMO

You can also adjust the delay time of the output audio. Press the [MENU] button → touch <Reverb/Delay> → use "Delay" to adjust the delay time of the desired audio bus.

Applying Effects to Input Audio

You can apply effects to the input audio to adjust the character of the sound. The following table shows the effects that are available.

Input audio	Reverb	Gate	Compressor	Equalizer	High-pass filter	Voice changer	Anti-feedback
Channels 1–4	✓	✓	✓	✓	✓	✓	✓
Channels 5/6, 7/8 (MIC)	✓	✓	✓	✓	✓	✓	✓
Channels 5/6, 7/8 (LINE, VIDEO)	✓	✓	✓	✓	✓	—	—
Channels 9/10, 11/12	✓	✓	✓	✓	✓	—	—

1. Press the [SELECT] button of the channel whose settings you want to change; the Audio Ch. screen appears.
2. Touch a menu item, and edit its setting.

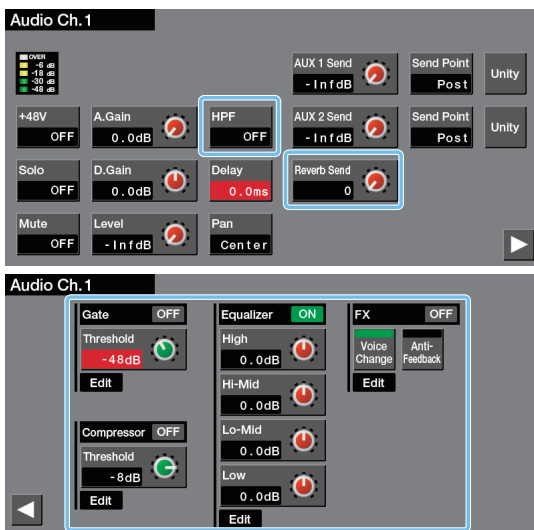

- When you touch <Edit>, a detailed screen for the effect appears.
- For details on the menu items, refer to “Menu List” (p. 37–40).

3. Press the lit [SELECT] button to close the menu screen.

● Reverb

Adds reverberation to the sound.

● Gate

Eliminates audio that is lower than the specified threshold level. This is effective when the noise that you want to remove is separate from the audio that you want to keep, and can be used to remove hiss or other noise that is heard during periods of silence.

● Compressor

Audio that exceeds the specified threshold level is compressed. This reduces the difference between the maximum volume and minimum volume, making the audio more comfortable for listening.

● Equalizer

This is a four-band parametric equalizer. It lets you shape the character of the sound by boosting or cutting four frequency regions. The width of the frequency regions can be changed.

● High-pass filter (HPF)

Cuts off unneeded low-band audio. The cutoff frequency is 80 Hz.

● Voice changer

Transforms the pitch or character of the voice that is input from the mic. You can create transformations such as “from a female to a male voice,” “from a male to a female voice,” or “robot voice.”

● Anti-feedback

Decreases the unpleasant acoustic feedback that occurs when a mic is brought near a speaker.

Applying Reverb

1. Press the [SELECT] button of the channel whose settings you want to change; the Audio Ch. screen appears.
2. Touch <Reverb Send>, and then use the [VALUE] knob to adjust the amount of audio that is sent to reverb.

This adjusts the reverb depth individually for each channel.

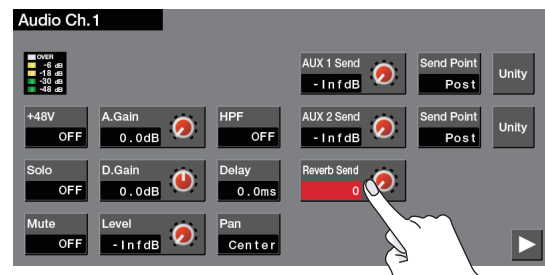

3. Press the lit [SELECT] button to close the menu screen.
4. Press the [MENU] button → touch <Reverb/Delay>.

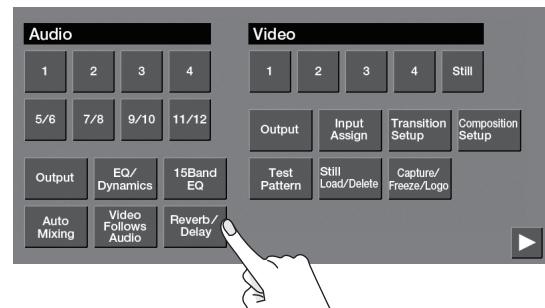

5. Touch <Reverb> to turn it “ON.”

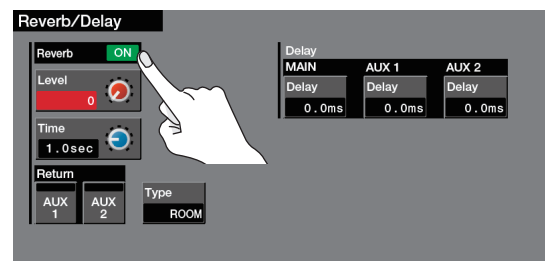

6. Touch a menu item to select it, and adjust the character of the reverb.

Menu item	Explanation
Level	Specifies the amount of sound that is returned from the reverb (return level). This adjusts the depth of the overall reverb.
Time	Specifies the time until the reverberation is no longer heard.
Type	Specifies the reverb type.

7. Press the [MENU] button to close the menu screen.

Applying Effects to Output Audio

Here's how to modify the tonal character by applying effects to the audio output. You can use compressor, limiter, and two types of equalizer.

1. Press the [MENU] button → touch <EQ/Dynamics> or <15Band EQ>.

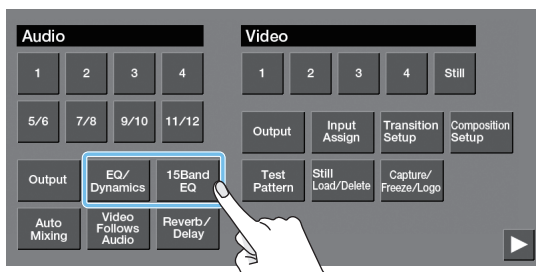

<EQ/Dynamics>	4-band parametric equalizer Compressor Limiter
<15Band EQ>	15 band graphic equalizer

2. Touch a menu item, and edit its setting.

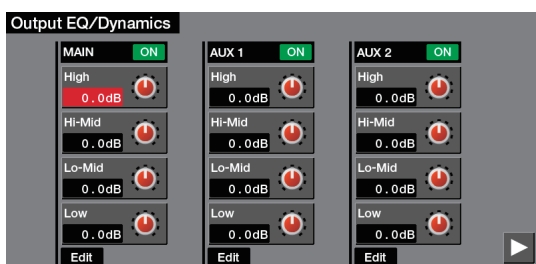

- When you touch <Edit>, a detailed screen for the effect appears.
- For details on the menu items, refer to "Menu List" (p. 42, 43).

3. Press the [MENU] button to close the menu screen.

● Equalizer (EQ)

This is a 4-band parametric equalizer. It lets you shape the character of the sound by boosting or cutting four frequency regions. The width of the frequency regions can be changed.

● Compressor (Comp)

Audio that exceeds the specified threshold level is compressed. This reduces the difference between the maximum volume and minimum volume, making the audio more comfortable for listening.

● Limiter (Lim)

Compresses the audio so that the mixed audio does not exceed the specified threshold level.

* Distortion will occur if audio that exceeds the allowable range of the limiter is input.

● 15-band equalizer (15Band EQ)

This is a 15-band graphic equalizer. It lets you shape the character of the sound by boosting or cutting each of the 15 frequency regions into which the sound is divided.

Interlinking Audio Output to Video Switching (Audio Follow)

Here's how the audio output can be automatically switched in tandem with video switching (the Audio Follow function).

The Audio Follow function applies to the audio of channels 5/6–11/12. The video and audio are linked in the following combinations.

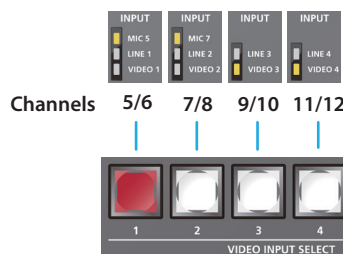

For example, the audio of channels 5/6 is output only when the VIDEO INPUT SELECT [1] button is selected.

If a VIDEO INPUT SELECT button other than the [1] button is selected, the audio is automatically muted.

1. Press the [SELECT] button of the channel whose settings you want to change; the Audio Ch. screen appears.
2. Touch <Follow> to turn it "ON."

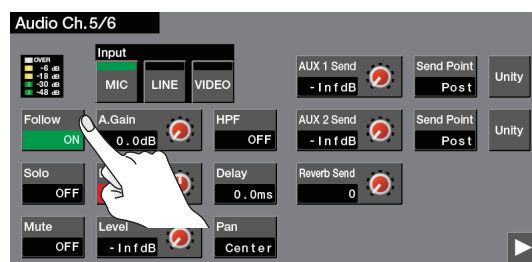

Value	Explanation
ON	The audio is output only when the video corresponding to the audio channel is selected. The audio is automatically muted if another video is selected.
OFF	The audio is always output regardless of the video selection.

3. Press the lit [SELECT] button to close the menu screen.

MEMO

- If the Video Follows Audio function (p. 16) is on, this function automatically turns off and cannot be specified.
- If the Audio Follow function is on, the FOLLOW indicator shows the output status of the audio.



Lit color	Output status
Lit green	Audio is not being output.
Lit red	Audio is being output.
Blinking red	Audio is being faded-in/out.

Controlling Volume Levels Automatically (Auto Mixing)

This automatically controls the volume that normally are adjusted by an operator using the faders (Auto Mixing function).

It lets you rely on this unit to perform complex volume-adjustment operations, enabling use in circumstances where no dedicated operator is assigned. This is especially useful for meetings, discussions, debates, and other situations where multiple microphones are used.

1. As described in “Adjusting the Input Gain (Sensitivity)” (p. 24), adjust the input gain of the channels for which you want to use auto mixing.

2. Press the [MENU] button → touch <Auto Mixing>.

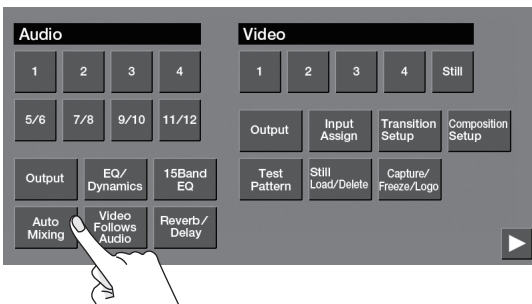

3. Touch <Auto Mixing> to turn it “ON.”

The auto mixing function turns on.

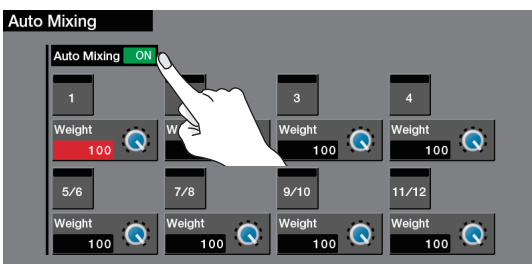

4. Touch the channel switch to turn on (lit) each channel for which you want to use auto mixing.

For audio that does not require auto mixing, such as background music, choose “OFF.”

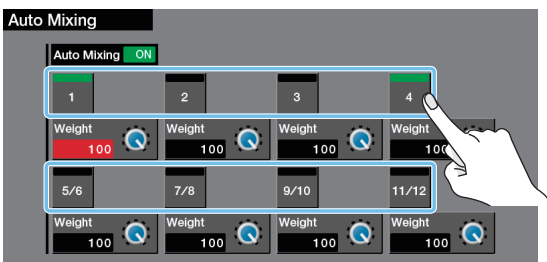

5. Touch <Weight>, and then use the [VALUE] knob to specify the weight level (the priority of volume distribution).

If there is audio that you want to make more prominent, such as when you want to raise the volume level of an emcee microphone, raise the weight level of that audio to emphasize it, and lower the weight level for other audio.

- On audio to which Auto Mixing is applied, setting the weight level to “0” results in no audio output.
- When air-conditioner noise or the like is a concern, set the weight level to a low value.

6. Press the [MENU] button to close the menu screen.

Checking a Specific Audio (Solo)

Here’s how you can temporarily monitor only specific audio in the headphones (the solo function).

1. Press the [SOLO] button of the channel that you want to solo, turning the solo function on (lit).

In the headphones, you hear only the audio for which this is on.



MEMO

- The audio for which the solo function is on can also be output from the AUX 2/MONITOR OUT jacks.

Press [MENU] button → Audio <Output> → <▶> → set “AUDIO AUX 2” to “MON.”

- You can also solo the audio of the AUX 1 or AUX 2 bus (p. 29). Press the MAIN [SELECT] button → set the AUX 1 or AUX 2 “Solo” to “ON.”

Muting Only Specific Audio (Mute)

Here’s how you can temporarily mute specific audio (the mute function).

1. Press the [MUTE] button of the channel that you want to mute, turning the mute function on (lit).

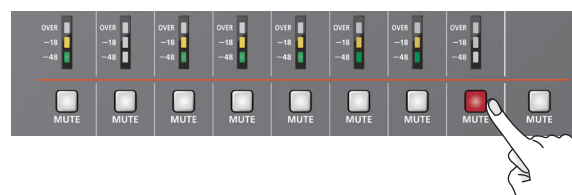

MEMO

- You can also mute the audio of the AUX 1 or AUX 2 bus (p. 29). Press the MAIN [SELECT] button → set the AUX 1 or AUX 2 “Mute” to “ON.”

Outputting AUX-bus Audio

This unit has three audio buses: MAIN, AUX 1, and AUX 2. You can assign a desired bus to each output connector.

For example, in a live event, you might output a mix of all audio inputs (the MAIN bus), while separately outputting a mix of only specific audio inputs (the AUX 1 bus) for recording or streaming.

MAIN bus	This mixes and outputs all input audio (main output).
AUX 1, 2 buses	This mixes and outputs only the input audio that is sent to the AUX 1 or AUX 2 bus. This allows you to output audio that is different than the main output.

Assigning the AUX bus

1. Press the MAIN [SELECT] button to display the Audio Output screen.

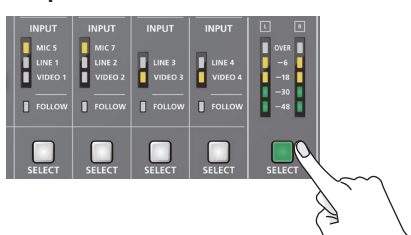

2. Touch <▶> → touch <AUX 1> or <AUX 2> for the jacks to which you want to assign the AUX bus.

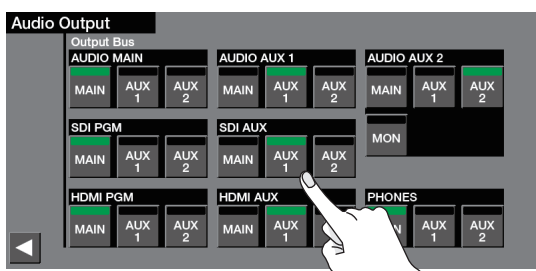

3. Press the MAIN [SELECT] button to close the menu screen.

Sending audio to the AUX bus

1. Press the [SELECT] button of the channel whose settings you want to change; the Audio Ch. screen appears.

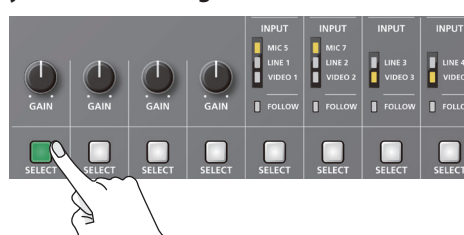

2. Touch <AUX 1 Send>, and then use the [VALUE] knob to adjust the amount of audio sent to the AUX 1 bus. For the AUX 2 bus, adjust "AUX 2 Send."

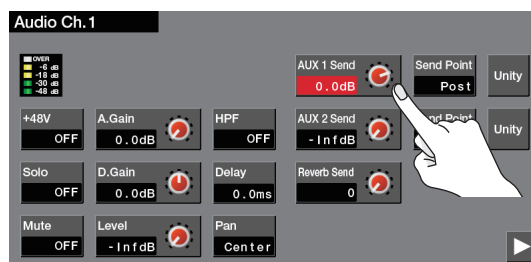

3. Press the lit [SELECT] button to close the menu screen.

Adjusting the Volume of the AUX Bus

1. Press the MAIN [SELECT] button to display the Audio Output screen.
2. Touch AUX 1 <Level>, and then use the [VALUE] knob to adjust the volume. For the AUX 2 bus, adjust AUX 2 "Level."

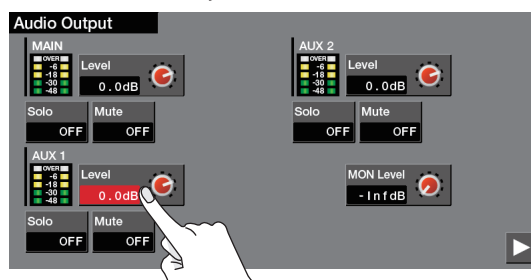

3. Press the MAIN [SELECT] button to close the menu screen.

Remotely Controlling a Camera

You can connect up to six cameras via the LAN port and remotely control them from this unit. Remote cameras made by JVC and Panasonic are supported.

* Refer also to the owner's manual of your camera.

Network Settings on the Camera

In order to control a camera from this unit, you need to make network settings on the camera. You can register up to six cameras.

1. Press the [MENU] button → touch → Network <Camera Control> → <Setup>.

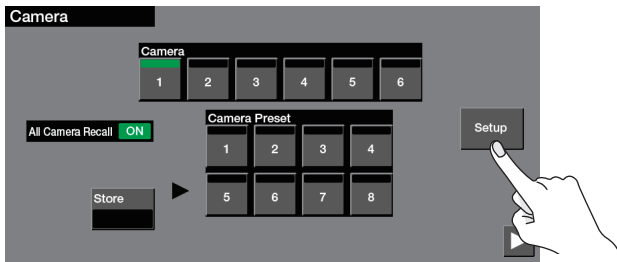

2. Touch a menu item to select it, and make network settings.

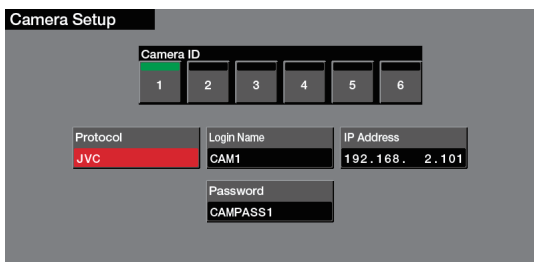

Menu item	Explanation
Camera ID	Selects the camera to be controlled.
Protocol	Specifies the camera's protocol. JVC camera: JVC Panasonic camera: Panasonic
Login Name	When "PROTOCOL" is "JVC" Touch to access a screen where you can input the login name. Enter the log-in name needed to connect with the camera.
Password	When "PROTOCOL" is "JVC" Touch to access a screen where you can input the password. Enter the password needed to connect with the camera.
IP Address	Input the camera's IP address.

3. Press the [MENU] button to close the menu screen.

Registering Camera Settings in a Preset

Up to eight sets of settings such as camera position and focus can be registered as presets.

A registered preset can be recalled when needed.

* Presets are saved in the camera itself.

1. Press the [MENU] button → → Network <Camera Control> → "Camera" to select the camera ID that you want to operate.

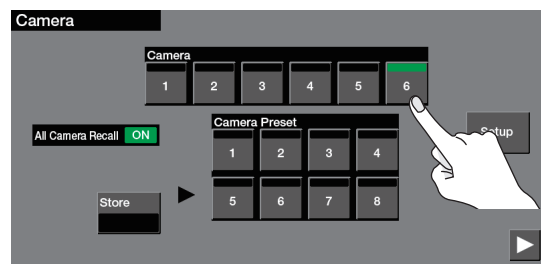

2. To operate camera settings, touch → and touch the screen to select menu items.

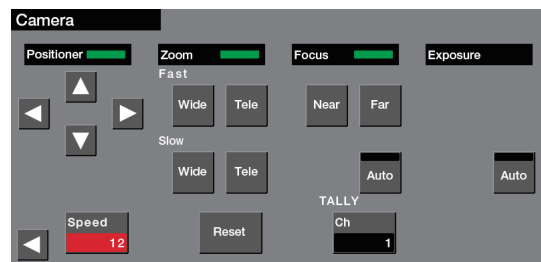

Menu item	Explanation	
Positioner		Adjusts the horizontal position. (*1)
		Adjusts the vertical position. (*1)
	Speed	Adjusts the speed at which the camera changes direction.
Zoom	Fast Wide	Zooms-out at high speed. (*1)
	Fast Tele	Zooms-in at high speed. (*1)
	Slow Wide	Zooms-out at low speed. (*1)
	Slow Tele	Zooms-in at low speed. (*1)
Reset	Resets the zoom position.	
FOCUS	Near	The focus moves closer. (*1)
	Far	The focal point moves farther away. (*1)
	Auto	If this is "ON," the focal point is set automatically.
Exposure	Auto	Specifies the exposure mode (auto/manual). If this is on, auto mode is enabled.
TALLY	Ch	Specifies the number of the video input to which the camera's video is being input. When the camera video from this unit is the program output, the camera's tally light is lit.

(*1) The camera is operated while you touch the item.

3. Touch < [MENU] > → <Store> to make it light red.

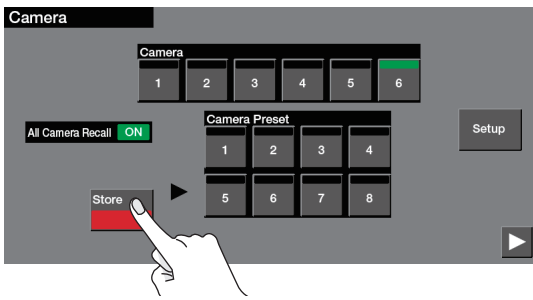

4. In "Camera Preset," touch the preset number in which you want to register the settings.

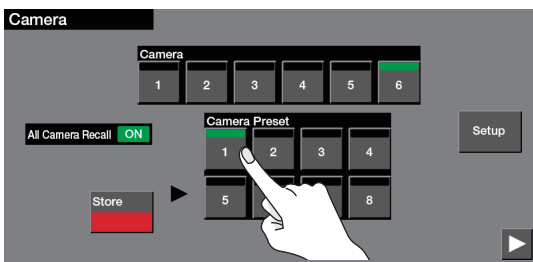

The camera settings are registered in the preset.

5. Press the [MENU] button to close the menu screen.

Recalling a Preset

Recalling from All Cameras Simultaneously

1. Press the [MENU] button → < [MENU] > → Network <Camera Control> → touch <All Camera Recall> to turn it "ON."

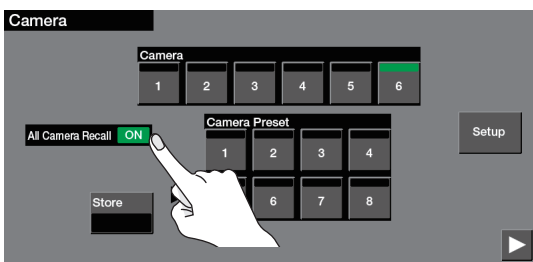

2. In "Camera Preset," touch the preset number that you want to recall.

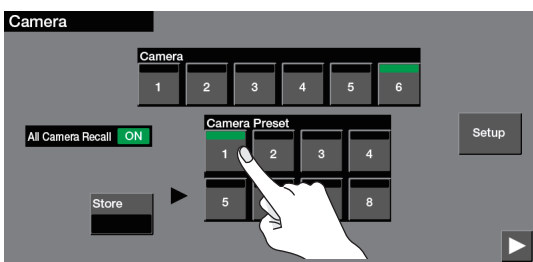

Presets are recalled from all cameras simultaneously.

3. Press the [MENU] button to close the menu screen.

Recalling from a Single Camera

1. Press the [MENU] button → < [MENU] > → Network <Camera Control> → touch <All Camera Recall> to turn it "OFF."

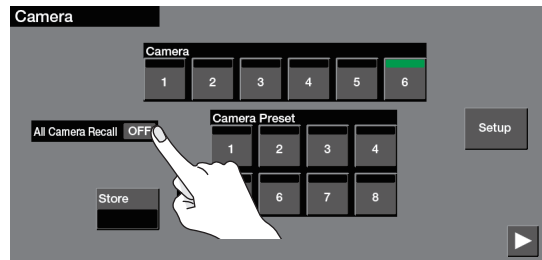

2. In "Camera," select the camera ID for which you want to recall a preset.

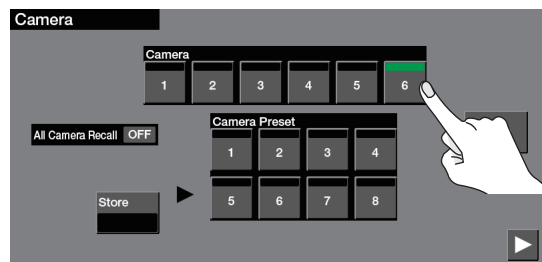

3. In "Camera Preset," touch the preset number that you want to recall.

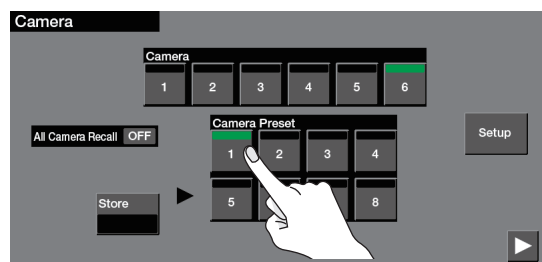

The preset recalled from the camera.

4. Press the [MENU] button to close the menu screen.

Live Streaming

Outputting Video/Audio to a Computer for Streaming

Here's how the video and audio mixed by this unit can be output to a connected computer. By using an internet-connected computer with streaming software, you can distribute content as a live internet stream.

- * In order for the audio and video from this unit to be correctly viewed on the computer, software that supports the USB video class and USB audio class must be installed on the computer.
- * For the latest operating requirements, refer to the Roland website (<https://proav.roland.com/>).

1. Turn on the power to this unit.
2. Start the computer.
3. Using a USB 3.0 cable, connect a USB 3.0 port on the computer to the USB STREAM port on this unit.
When communication with the computer has been established, the computer recognizes this unit as a USB video device and USB audio device.
* The first time that this unit is connected to the computer, the standard drivers of the operating system are installed automatically.
4. Make settings for the video/audio that will be output via USB.

- ① Press the [MENU] button → touch <▶> → System <USB Streaming>.
- ② Touch a menu item to select it, and item and make video/audio settings.

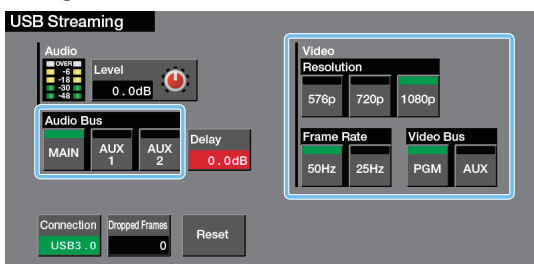

Menu item	Explanation	
Video	Resolution	Specifies the output format.
	Frame Rate	Specifies the frame rate.
	Video Bus	Specify the video bus (p. 12) that you want to assign to the USB Streaming port.
Audio	Audio Bus	Specify the audio bus (p. 29) that you want to assign to the USB Streaming port.

5. Operate this unit to output video/audio to your computer.
6. On your computer, verify the input from this unit.
Start software that supports the USB video class and audio class, and verify the video and audio that are being input from this unit.
7. Use the [USB AUDIO] knob to adjust the volume of the USB output.

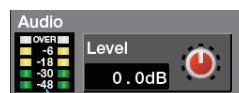

The volume is appropriate when the yellow indicator lights.

According to the audio bus assignment, the following volume is adjusted.

"Audio Bus" setting	Explanation
MAIN	Volume of the main output
AUX 1, AUX 2	Volume of the AUX 1 or AUX 2 bus

8. Press the [MENU] button to close the menu screen.

MEMO

If there is a timing discrepancy between the video and the audio, use "Delay" to adjust the delay time for the USB output audio.

Checking the USB connection status

When the connection is established, the "Connection" area indicates the current status (USB 2.0 or USB 3.0).

If this indicates "NC," a connection is not established.



If you have these problems

Operation is unstable, such as if a connection cannot be established, or the video is disordered

Touch <Reset> and try reconnecting this unit to your computer.

The "Dropped Frames" number is increasing

Normally this indicates "0." If the number is increasing, video transmission is not fast enough.

Either use "Resolution" to lower the output format, or use "Frame Rate" to lower the frame rate.

Capturing video on the computer

Using dedicated "Video Capture for VR" software, the video and audio that are output from this unit via USB can be recorded on your computer.

For details on operation, refer to the Owner's Manual included with "Video Capture for VR."



You can download "Video Capture for VR" from the Roland website. <https://proav.roland.com/>

Other Features

Saving/Recalling Settings (Memory)

You can save the current settings, including the video/audio settings and the state of the operating panel, in memory and recall those settings for use when necessary. This unit is provided with eight memories.

About the Last Memory function

This unit has a built-in Last Memory feature. Last Memory is a feature that saves the state of the unit that is in effect immediately before power-down, and automatically restores the state at the next startup. The Last Memory feature is enabled by default. If you don't want to use the Last Memory function, press the [MENU] button → System <Memory> → "Start Up" to specify the memory number that is recalled at startup.

Saving to a Memory

1. Press the [MENU] button → touch <▶> → System <Memory>.

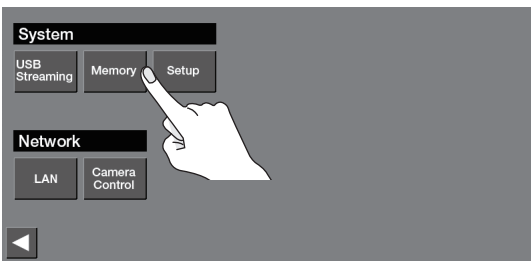

2. Touch <Store> to make it light red.

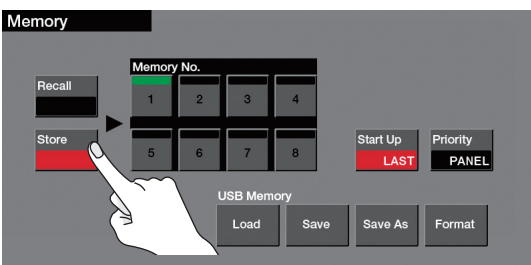

3. In "Memory No.," touch the save-destination memory number.

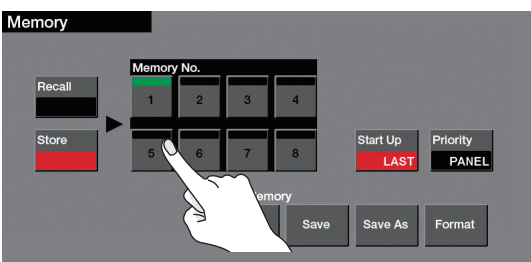

The current settings are saved.

4. Press the [MENU] button to close the menu screen.

MEMO

- **About the fader/knob setting values**
With the factory settings, when you recall a memory or start up the unit, the values reflect the current position of the faders and knobs.
If you want the values saved in memory to be applied, set [MENU] button → System <Memory> → "Priority" to "MEMORY."
- Since system and network settings are common to the entire unit, they are not saved in a memory. For details, refer to "Store" in "Memory Screen" (p. 53).

Recalling a Memory

NOTE

Before you recall settings that have phantom power turned on, including at startup, make sure that condenser mics requiring phantom power are the only devices connected.

You risk causing damage if you mistakenly supply phantom power to dynamic microphones, audio playback devices, or other devices that don't require such power.

1. Press the [MENU] button → touch <▶> → System <Memory>.

2. Touch <Recall> to make it light green.

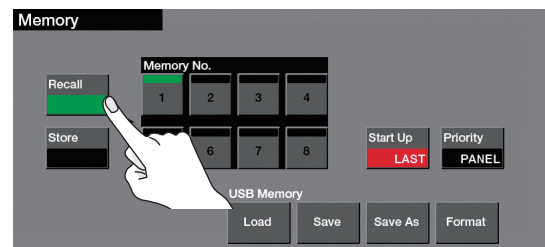

3. In "Memory No.," touch the save-destination memory number.

For memories in which settings are saved, the memory number is shown in white.

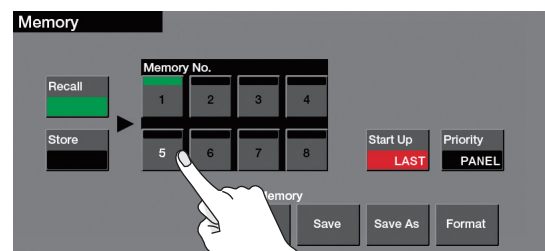

The settings are recalled.

4. Press the [MENU] button to close the menu screen.

Saving the Unit's Settings on a USB Flash Drive

You can group together the unit's settings into a single file (.V50) and save it to a USB flash drive connected to the USB MEMORY port. You can access the saved setting file on the USB flash drive and load it into the unit for use when needed.

NOTE

- When using a USB flash drive for the first time, you must format it using this unit (p. 35).
- Never turn off the power or remove the USB flash drive while the message "Processing." is shown.
- Depending on the USB flash drive, recognition of the flash drive might take some time.

Saving a New File

1. Press the [MENU] button → touch <▶> → System <Memory>.

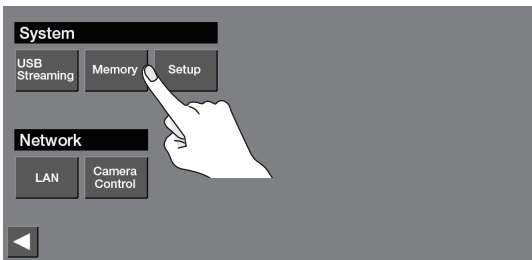

2. Touch USB Memory <Save As>.

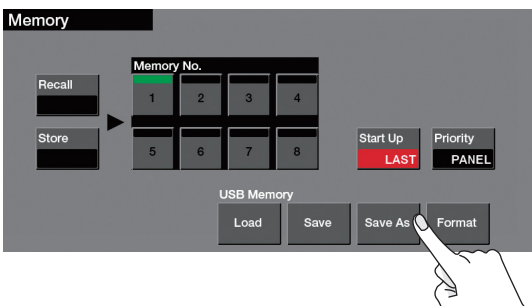

3. Touch <◀> <▶> to move the cursor, and use the [VALUE] knob to enter the file name.



<Insert>	Inserts a space at the cursor location.
<Delete>	Deletes the character at the cursor location.

If you want to cancel the operation, press the [EXIT] button.

4. When you have finished entering the name, press the [ENTER] button.

The current settings are saved to the USB flash drive as a file.

5. Press the [MENU] button to close the menu screen.

Overwrite-saving

1. Press the [MENU] button → touch <▶> → System <Memory> → USB Memory <Save>.
2. Touch to select the settings file that you want to overwrite.

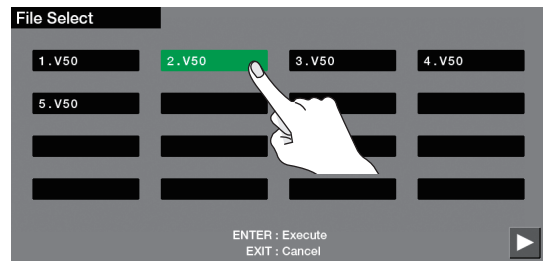

If you want to cancel the operation, press the [EXIT] button.

3. Press the [ENTER] button.
The settings file is overwrite-saved.
4. Press the [MENU] button to close the menu screen.

Loading

Here's how to load this unit's settings that you saved on a USB flash drive. When you load settings, the current settings are overwritten.

1. Press the [MENU] button → touch <▶> → System <Memory> → USB Memory <Load>.
2. Touch to select the settings file that you want to recall.

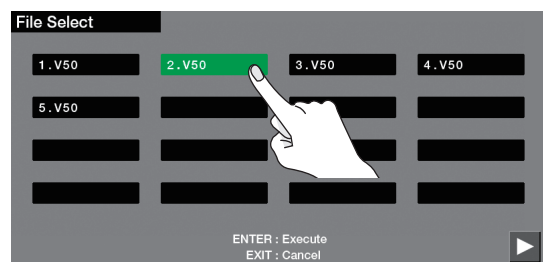

If you want to cancel the operation, press the [EXIT] button.

3. Press the [ENTER] button.
The settings are loaded.

MEMO

Content that is not saved to the file

- "Test Pattern" and "Test Tone" settings (p. 52). The unit always starts with these "OFF"
- The still images loaded into the unit. Only the file names of the still images are saved.
- The state of the [OUTPUT FADE] button. Always unlit at startup.

Formatting a USB Flash Drive

The first time that you use a USB flash drive, you must use this unit to format it.

NOTE

- A USB flash drive that was not formatted by this unit will not be recognized.
- Never turn off the power or remove the USB flash drive while the message "Processing" is shown.
- When you format a USB flash drive, all data on that USB flash drive is erased. If the drive contains important data, back it up to your computer before you format the drive.

1. Connect the USB flash drive to the USB MEMORY port.



* Ensure that the USB flash drive is oriented correctly, and insert it all the way into the port. Do not use excessive force.

2. Press the [MENU] button → touch <▶> → System <Memory>.

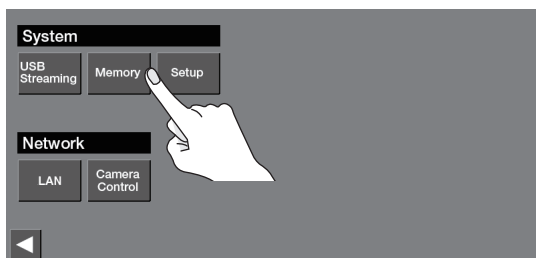

3. Touch <Format>.

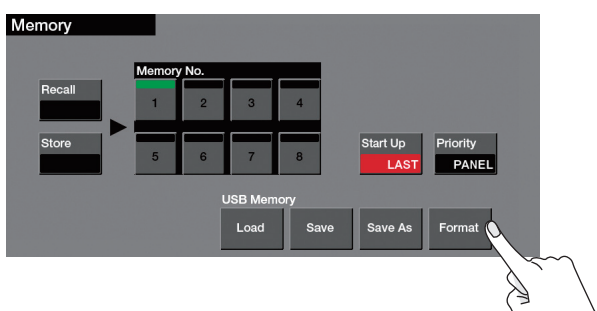

A confirmation message appears.

If you want to cancel the operation, press the [EXIT] button.

4. To format the USB flash drive, press the [ENTER] button.

Formatting is executed.

5. Press the [MENU] button to close the menu screen.

Renaming the Monitor Label

You can rename the labels that are shown on the monitor for the input/output video or still images. The label can be up to eight characters.

1. Press the [MENU] button → touch <▶> → System <Setup>.

2. Touch <▶> → Touch Panel <Label>.

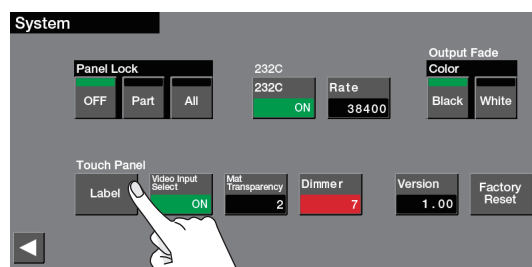

3. Touch the label that you want to rename.

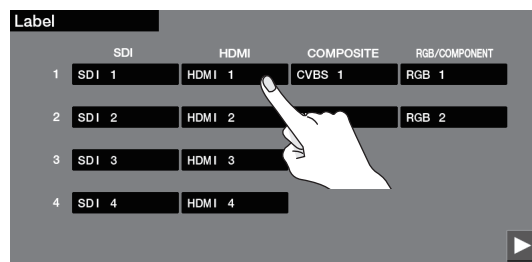

4. Touch <◀><▶> to move the cursor, and use the [VALUE] knob to enter the label name.

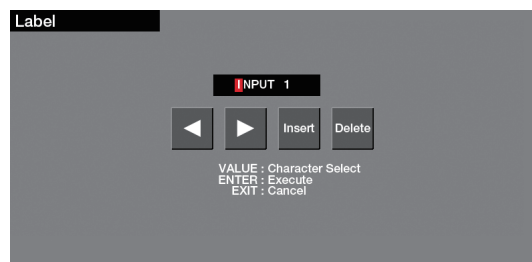

<Insert> Inserts a space at the cursor location.

<Delete> Deletes the character at the cursor location.

If you decide to cancel the entry, press the [EXIT] button.

5. When you have finished entering the label, press the [ENTER] button to confirm the label name.

6. Press the [MENU] button to close the menu screen.

MEMO

You can hide the tally border and label that are shown in the multi-view that is output from the MULTI-VIEW connector.

Use the [MENU] button → <▶> → System <Setup> → <▶> → Touch Panel <Label> → <▶> → and set "MULTI-VIEW Label" to "OFF"

Returning to the Factory Settings (Factory Reset)

Here's how you can return the settings of this unit to their factory-set state. If following the procedures described in this manual does not cause the result you expect, try executing a factory reset.

NOTE

- When you execute factory reset, any previously specified content, any settings saved in memory (p. 33), and the still image (p. 14) saved in the unit will all be lost.
- Never turn off the power or remove the USB flash drive while the message "Processing." is shown.

1. Press the [MENU] button → touch <▶> → System <Setup>.

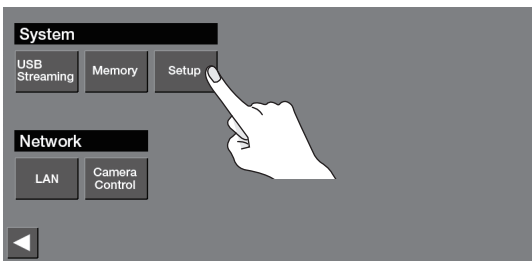

2. Touch <▶> → <Factory Reset>.

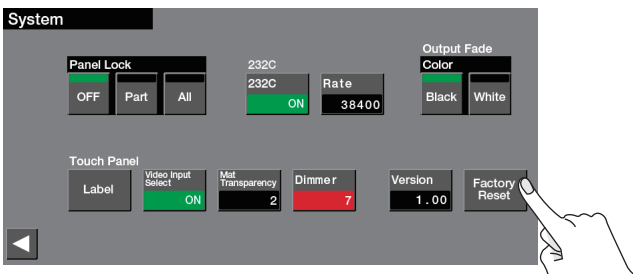

A confirmation message appears.
If you want to cancel the operation, press the [EXIT] button.

3. To perform a factory reset, press the [ENTER] button.
Factory reset is executed.

4. Press the [MENU] button to close the menu screen.

Menu List

Audio

Audio Ch. 1–4 Screen (Press a channel 1–4 [SELECT] button, or [MENU] button → Audio <1>–<4>)

These settings adjust the input audio of channels 1–4.

Menu item	Value (bold text: default value)	Explanation
+48V	OFF , ON	Turns the phantom power on/off. If this is "ON," phantom power is supplied via the AUDIO IN jacks (XLR).
Solo	OFF , ON	Turns the solo function on/off. Only the audio for which this is "ON" is heard in the headphones.
Mute	OFF , ON	Turns the mute function on/off. If this is "ON," the audio is temporarily silenced.
A.Gain	0.0 –+68.0dB	Adjusts the input gain (sensitivity) in the analog domain. * This can also be adjusted by the [GAIN] knob.
D.Gain	-42.0– 0.0 –+42.0dB	Adjusts the input gain (sensitivity) in the digital domain (after conversion from analog to digital).
Level	-Inf –10.0dB	Adjusts the input volume. * This can also be adjusted by the channel fader.
HPF	OFF , ON	Turns the high-pass filter on/off. Effect Cuts off unneeded low-band audio. The cutoff frequency is 80 Hz.
Delay	0.0 –500.0ms	Adjusts the delay time of the audio. Delays the output of the audio by the specified time.
Pan	Left, L49–L01, Center R01–R49, Right	Adjusts the stereo position (pan).
AUX 1 Send	-Inf –10.0dB	Adjusts the amount of audio sent to the AUX 1 bus.
Send Point	Specifies the position from which the audio sent to the AUX 1 bus is taken.	
	Pre	Send the audio before it is adjusted by the fader (pre-fader).
	Post	Send the audio after it passes through the fader (post-fader).
Unity	—	Sets "AUX 1 Send" to unity (0.0 dB).
AUX 2 Send	-Inf –+10.0dB	Adjusts the amount of audio sent to the AUX 2 bus.
Send Point	Specifies the position from which the audio sent to the AUX 2 bus is taken.	
	Pre	Send the audio before it is adjusted by the fader (pre-fader).
	Post	Send the audio after it passes through the fader (post-fader).
Unity	—	Sets "AUX 2 Send" to unity (0.0 dB).
Reverb Send	0 –127	Adjusts the amount of audio sent to reverb.

Gate

Gate	OFF , ON	Turns the gate on/off. Effect Eliminates audio that is lower than the specified threshold level. This is effective when the noise that you want to remove is separate from the audio that you want to keep, and can be used to remove hiss or other noise that is heard during periods of silence.
Threshold	-80– -48 –0dB	Specifies the level used as the threshold for removing audio.
Release	30– 500 –5000ms	Specifies the length of time until the audio is fully attenuated after audio falls below the threshold.

Compressor

Compressor	OFF , ON	Turns the compressor on/off. Effect Audio that exceeds the specified threshold level is compressed. This reduces the difference between the maximum volume and minimum volume, making the audio more comfortable for listening.
Threshold	-50– -8 –0dB	Specifies the level used as the threshold at which the compressor is applied. Compression is applied to audio that exceeds the threshold.
Ratio	1.00 : 1, 1.12 : 1, 1.25 : 1 1.40 : 1, 1.60 : 1, 1.80 : 1 2.00 : 1, 2.50 : 1 , 3.20 : 1 4.00 : 1, 5.60 : 1, 8.00 : 1 16.0 : 1, INF : 1	Specifies the degree of compression applied to the audio. The state in which no compression is applied is defined as "1."
Attack	0– 30 –100ms	Adjusts the time from when audio exceeding the threshold is input until when compression begins.
Release	30– 250 –5000ms	Adjusts the length of time until compression ends after audio falls below the threshold.
Makeup	-40– 0 –40dB	Adjusts the output volume level after applying the compressor.

Menu List

Menu item	Value (bold text: default value)	Explanation
Equalizer When you touch <Edit>, a detailed screen for the effect appears.		
Equalizer	OFF, ON	Turns the equalizer on/off. Effect This is a 4-band parametric equalizer. It lets you shape the character of the sound by boosting or cutting four frequency regions.
High	-15.0- 0.0 - +15.0dB	Boosts or attenuates the high band.
Frequency	1.0- 10.0 -20.0kHz	Adjusts the center frequency when changing the tone quality in the high band.
Hi-Mid	-15- 0 - +15dB	Boosts or attenuates the high-midrange band.
Frequency	20.0Hz- 2.0kHz -20.0kHz	Adjusts the center frequency when changing the tone quality in the high-midrange band.
Q	0.3- 1.0 -16.0	Adjusts the width of the frequency band when boosting or attenuating high-midrange band.
Lo-Mid	-15- 0 - +15dB	Boosts or attenuates the low-midrange band.
Frequency	20Hz- 500Hz -20.0kHz	Adjusts the center frequency when changing the tone quality in the low-midrange band.
Q	0.3- 1.0 -16.0	Adjusts the width of the frequency band when boosting or attenuating low-midrange band.
Low	-15- 0 - +15dB	Boosts or attenuates the low band.
Frequency	20Hz- 100Hz -2.0kHz	Adjusts the center frequency when changing the tone quality in the low band.
FX		
FX	OFF , ON	Turns the voice changer or anti-feedback on/off.
Voice Change	Selects the voice changer or anti-feedback.	
Anti-Feedback	Voice Change	Transforms the pitch or character of the voice that is input from the mic.
	Anti-Feedback	Decreases the unpleasant acoustic feedback that occurs when a mic is brought near a speaker.
Voice Change When you touch <Edit>, a detailed screen for the effect appears.		
Pitch	-12- +12	Adjusts the pitch of the voice in semitone steps. A setting of "0" is the original pitch.
Formant	-10- +4 - +10	Adjusts the character (formant) of the voice. Settings in the negative (-) direction produce a more masculine vocal character, and settings in the positive (+) direction produce a more feminine vocal character. A setting of "0" is the original voice.
Robot	OFF , ON	If this is "ON," the voice is held at a fixed pitch, creating a mechanical robot-like impression.
Mix	0- 100	Adjusts the balance between the unprocessed voice (0) and the voice processed by the effect (100).

Audio Ch. 5/6–11/12 Screen (Press a channel 5/6–11/12 [SELECT] button, or [MENU] button → Audio <5/6>–<11/12>)

These settings adjust the input audio of channels 5/6–11/12.

Menu item	Value (bold text: default value)	Explanation																								
Follow		Turns the Audio Follow function on/off. Audio follow is a function that automatically switches the audio output in tandem with video switching. * If the Video Follows Audio function (p. 16) is on, this function automatically turns off and cannot be specified.																								
	OFF	The audio is always output regardless of the video selection.																								
	ON	The audio is output only when the video corresponding to the audio channel is selected. The audio is automatically muted if another video is selected.																								
Solo	OFF , ON	Turns the solo function on/off. Only the audio for which this is "ON" is heard in the headphones.																								
Mute	OFF , ON	Turns the mute function on/off. If this is "ON," the audio is temporarily silenced.																								
Input	MIC, LINE , VIDEO	Selects the audio source that is input to the channel. If "VIDEO" is selected, channels 1 and 2 of the SDI or HDMI embedded audio are input.																								
		<table border="1"> <thead> <tr> <th>Value</th> <th>Ch. 5/6</th> <th>Ch. 7/8</th> <th>Ch. 9/10</th> <th>Ch. 11/12</th> </tr> </thead> <tbody> <tr> <td>MIC</td> <td>MIC 5</td> <td>MIC 7</td> <td>—</td> <td>—</td> </tr> <tr> <td>LINE</td> <td>LINE 1</td> <td>LINE 2</td> <td>LINE 3</td> <td>LINE 4</td> </tr> <tr> <td rowspan="2">VIDEO</td> <td>HDMI IN 1</td> <td>HDMI IN 2</td> <td>HDMI IN 3</td> <td>HDMI IN 4</td> </tr> <tr> <td>SDI IN 1</td> <td>SDI IN 2</td> <td>SDI IN 3</td> <td>SDI IN 4</td> </tr> </tbody> </table>	Value	Ch. 5/6	Ch. 7/8	Ch. 9/10	Ch. 11/12	MIC	MIC 5	MIC 7	—	—	LINE	LINE 1	LINE 2	LINE 3	LINE 4	VIDEO	HDMI IN 1	HDMI IN 2	HDMI IN 3	HDMI IN 4	SDI IN 1	SDI IN 2	SDI IN 3	SDI IN 4
		Value	Ch. 5/6	Ch. 7/8	Ch. 9/10	Ch. 11/12																				
		MIC	MIC 5	MIC 7	—	—																				
LINE	LINE 1	LINE 2	LINE 3	LINE 4																						
VIDEO	HDMI IN 1	HDMI IN 2	HDMI IN 3	HDMI IN 4																						
	SDI IN 1	SDI IN 2	SDI IN 3	SDI IN 4																						
A.Gain (*1)	0.0 – +68.0dB	Adjusts the input gain (sensitivity) in the analog domain. * This can also be adjusted by the [MIC 5 GAIN] or [MIC 7 GAIN] knobs.																								
D.Gain	-42.0– 0.0 – +42.0dB	Adjusts the input gain (sensitivity) in the digital domain (after conversion from analog to digital).																								
Level	-Inf – +10.0dB	Adjusts the input volume. * This can also be adjusted by the channel fader.																								
HPF	OFF , ON	Turns the high-pass filter on/off. Effect Cuts off unneeded low-band audio. The cutoff frequency is 80 Hz.																								
Delay	0.0 –500.0ms	Adjusts the delay time of the audio. Delays the output of the audio by the specified time.																								
Pan (*1)	Left, L49–L01, Center R01–R49, Right	Adjusts the stereo position (pan).																								
Mono (*2)		Converts the input audio from stereo to mono.																								
	OFF	Sends the stereo input audio to the audio bus without change.																								
	L MONO	The audio of the L channel is sent to both L and R of the audio bus.																								
	R MONO	The audio of the R channel is sent to both L and R of the audio bus.																								
	LR MIX	The audio of the L channel and R channel is mixed, and sent to both L and R of the audio bus.																								
AUX 1 Send	-Inf – +10.0dB	Adjusts the amount of audio sent to the AUX 1 bus.																								
Send Point		Specifies the position from which the audio sent to the AUX 1 bus is taken.																								
	Pre	Send the audio before it is adjusted by the fader (pre-fader).																								
	Post	Send the audio after it passes through the fader (post-fader).																								
Unity	—	Sets "AUX 1 Send" to unity (0.0 dB).																								
AUX 2 Send	-Inf – +10.0dB	Adjusts the amount of audio sent to the AUX 2 bus.																								
Send Point		Specifies the position from which the audio sent to the AUX 2 bus is taken.																								
	Pre	Send the audio before it is adjusted by the fader (pre-fader).																								
	Post	Send the audio after it passes through the fader (post-fader).																								
Unity	—	Sets "AUX 2 Send" to unity (0.0 dB).																								
Reverb Send	0 –127	Adjusts the amount of audio sent to reverb.																								

(*1) Only for channels 5/6 and 7/8. This can be set if "Input" is "MIC."

(*2) This can be set if "Input" is "LINE" or "VIDEO."

Gate	When you touch <Edit>, a detailed screen for the effect appears.	
Gate	OFF , ON	Turns the gate on/off. Effect Eliminates audio that is lower than the specified threshold level. This is effective when the noise that you want to remove is separate from the audio that you want to keep, and can be used to remove hiss or other noise that is heard during periods of silence.
Threshold	-80– -48 –0dB	Specifies the level used as the threshold for removing audio.
Release	30– 500 –5000ms	Specifies the length of time until the audio is fully attenuated after audio falls below the threshold.

Menu List

Menu item	Value (bold text: default value)	Explanation
Compressor When you touch <Edit>, a detailed screen for the effect appears.		
Compressor	OFF , ON	Turns the compressor on/off. Effect Audio that exceeds the specified threshold level is compressed. This reduces the difference between the maximum volume and minimum volume, making the audio more comfortable for listening.
Threshold	-50– -8 –0dB	Specifies the level used as the threshold at which the compressor is applied. Compression is applied to audio that exceeds the threshold.
Ratio	1.00 : 1, 1.12 : 1, 1.25 : 1 1.40 : 1, 1.60 : 1, 1.80 : 1 2.00 : 1, 2.50 : 1 , 3.20 : 1 4.00 : 1, 5.60 : 1, 8.00 : 1 16.0 : 1, INF : 1	Specifies the degree of compression applied to the audio. The state in which no compression is applied is defined as "1."
Attack	0– 30 –100ms	Adjusts the time from when audio exceeding the threshold is input until when compression begins.
Release	30– 250 –5000ms	Adjusts the length of time until compression ends after audio falls below the threshold.
Makeup	-40– 0 –40dB	Adjusts the output volume level after applying the compressor.

Equalizer When you touch <Edit>, a detailed screen for the effect appears.		
Equalizer	OFF, ON	Turns the equalizer on/off. Effect This is a 4-band parametric equalizer. It lets you shape the character of the sound by boosting or cutting four frequency regions.
High	-15.0– 0.0 – +15.0dB	Boosts or attenuates the high band.
Frequency	1.0– 10.0 –20.0kHz	Adjusts the center frequency when changing the tone quality in the high band.
Hi-Mid	-15– 0 – +15dB	Boosts or attenuates the high-midrange band.
Frequency	20.0Hz– 2.0kHz –20.0kHz	Adjusts the center frequency when changing the tone quality in the high-midrange band.
Q	0.3– 1.0 –16.0	Adjusts the width of the frequency band when boosting or attenuating high-midrange band.
Lo-Mid	-15– 0 – +15dB	Boosts or attenuates the low-midrange band.
Frequency	20Hz– 500Hz –20.0kHz	Adjusts the center frequency when changing the tone quality in the low-midrange band.
Q	0.3– 1.0 –16.0	Adjusts the width of the frequency band when boosting or attenuating low-midrange band.
Low	-15– 0 – +15dB	Boosts or attenuates the low band.
Frequency	20Hz– 100Hz –2.0kHz	Adjusts the center frequency when changing the tone quality in the low band.

FX (*3)		
FX	OFF , ON	Turns the voice changer or anti-feedback on/off.
Voice Change Anti-Feedback	Selects the voice changer or anti-feedback.	
	Voice Change	Transforms the pitch or character of the voice that is input from the mic.
	Anti-Feedback	Decreases the unpleasant acoustic feedback that occurs when a mic is brought near a speaker.

Voice Change (*3) When you touch <Edit>, a detailed screen for the effect appears.		
Pitch	-12– +12	Adjusts the pitch of the voice in semitone steps. A setting of "0" is the original pitch.
Formant	-10– +4 – +10	Adjusts the character (formant) of the voice. Settings in the negative (-) direction produce a more masculine vocal character, and settings in the positive (+) direction produce a more feminine vocal character. A setting of "0" is the original voice.
Robot	OFF , ON	If this is "ON," the voice is held at a fixed pitch, creating a mechanical robot-like impression.
Mix	0– 100	Adjusts the balance between the unprocessed voice (0) and the voice processed by the effect (100).

(*3) Only for channels 5/6 and 7/8. This can be set if "Input" is "MIC."

Output Screen (Press the MAIN [SELECT] button, or [MENU] button → Audio <Output>)

Here you can make settings for the output audio.

Menu item	Value (bold text: default value)	Explanation
MAIN Adjusts the main output audio.		
Level	-Inf- +10.0dB	Adjusts the output volume. * This can also be adjusted by the [MAIN] fader.
Solo	OFF , ON	Turns the solo function on/off. Only the audio for which this is "ON" is heard in the headphones.
Mute	OFF , ON	Turns the mute function on/off. If this is "ON," the audio is temporarily silenced.
AUX 1 Adjusts the audio of the AUX 1 bus.		
Level	-Inf- +10.0dB	Adjusts the output volume.
Solo	OFF , ON	Turns the solo function on/off. Only the audio for which this is "ON" is heard in the headphones.
Mute	OFF , ON	Turns the mute function on/off. If this is "ON," the audio is temporarily silenced.
AUX 2 Adjusts the audio of the AUX 2 bus.		
Level	-Inf- +10.0dB	Adjusts the output volume.
Solo	OFF , ON	Turns the solo function on/off. Only the audio for which this is "ON" is heard in the headphones.
Mute	OFF , ON	Turns the mute function on/off. If this is "ON," the audio is temporarily silenced.
Mon Level (*4)	-Inf-0.0- +10.0dB	Adjusts the volume that is output from the AUX 2/MONITOR OUT jacks.

(*4) This is valid if the Output Bus's "AUDIO AUX 2" is "MON."

Output Bus								
AUDIO MAIN	MAIN , AUX 1, AUX 2	Specifies the audio bus that is assigned to each output connector.						
AUDIO AUX 1	MAIN, AUX 1 , AUX 2							
AUDIO AUX 2	MAIN, AUX 1, AUX 2 MON							
SDI PGM	MAIN , AUX 1, AUX 2							
SDI AUX	MAIN, AUX 1 , AUX 2							
HDMI PGM	MAIN , AUX 1, AUX 2							
HDMI AUX	MAIN, AUX 1 , AUX 2							
PHONES	MAIN , AUX 1, AUX 2							
		<table border="1"> <tr> <td>MAIN</td> <td>This mixes and outputs all input audio (main output).</td> </tr> <tr> <td>AUX 1</td> <td>This mixes and outputs only the input audio that is sent to the AUX 1 or AUX 2 bus. This allows you to output audio that is different than the main output.</td> </tr> <tr> <td>AUX 2</td> <td>This outputs the same audio as the headphones. Use "Mon Level" to adjust the volume. * This can be set only for the AUX 2/MONITOR OUT jacks.</td> </tr> </table>	MAIN	This mixes and outputs all input audio (main output).	AUX 1	This mixes and outputs only the input audio that is sent to the AUX 1 or AUX 2 bus. This allows you to output audio that is different than the main output.	AUX 2	This outputs the same audio as the headphones. Use "Mon Level" to adjust the volume. * This can be set only for the AUX 2/MONITOR OUT jacks.
MAIN	This mixes and outputs all input audio (main output).							
AUX 1	This mixes and outputs only the input audio that is sent to the AUX 1 or AUX 2 bus. This allows you to output audio that is different than the main output.							
AUX 2	This outputs the same audio as the headphones. Use "Mon Level" to adjust the volume. * This can be set only for the AUX 2/MONITOR OUT jacks.							

EQ/Dynamics Screen ((MENU) button → Audio <EQ/Dynamics> → <Edit>)

EQ

Here you can make settings for the four-band parametric equalizer. It lets you shape the character of the sound by boosting or cutting four frequency regions.

Menu item	Value (bold text: default value)	Explanation
MAIN Adjusts the main output audio.		
MAIN	OFF, ON	Turns the equalizer on/off.
High	-15.0- 0.0 - +15.0dB	Boosts or attenuates the high band.
Frequency	1.0- 10.0 -20.0kHz	Adjusts the center frequency when changing the tone quality in the high band.
Hi-Mid	-15- 0 - +15dB	Boosts or attenuates the high-midrange band.
Frequency	20.0Hz- 2.0kHz -20.0kHz	Adjusts the center frequency when changing the tone quality in the high-midrange band.
Q	0.3- 1.0 -16.0	Adjusts the width of the frequency band when boosting or attenuating high-midrange band.
Lo-Mid	-15- 0 - +15dB	Boosts or attenuates the low-midrange band.
Frequency	20Hz- 500Hz -20.0kHz	Adjusts the center frequency when changing the tone quality in the low-midrange band.
Q	0.3- 1.0 -16.0	Adjusts the width of the frequency band when boosting or attenuating low-midrange band.
Low	-15- 0 - +15dB	Boosts or attenuates the low band.
Frequency	20Hz- 100Hz -2.0kHz	Adjusts the center frequency when changing the tone quality in the low band.

AUX 1 (*5) Adjusts the audio of the AUX 1 bus.		
AUX 1	OFF, ON	Turns the equalizer on/off.

AUX 2 (*5) Adjusts the audio of the AUX 2 bus.		
AUX 2	OFF, ON	Turns the equalizer on/off.

(*5) Other menu items are the same as for "MAIN."

Dynamics

Here you can make compressor and limiter settings.

Menu item	Value (bold text: default value)	Explanation
MAIN Adjusts the main output audio.		
MAIN	OFF , ON	Turns the compressor or limiter on/off.
Comp Lim	Selects the compressor or limiter.	
	Comp	This is a compressor. Audio that exceeds the specified threshold level is compressed. This reduces the difference between the maximum volume and minimum volume, making the audio more comfortable for listening.
	Lim	This is a limiter. Compresses the audio so that the mixed audio does not exceed the specified threshold level. * Distortion will occur if audio that exceeds the allowable range of the limiter is input.

Comp		
Threshold	-50- -8 -0dB	Specifies the level used as the threshold at which the compressor is applied. Compression is applied to audio that exceeds the threshold.
Ratio	1.00 : 1, 1.12 : 1, 1.25 : 1 1.40 : 1, 1.60 : 1, 1.80 : 1 2.00 : 1, 2.50 : 1, 3.20 : 1 4.00 : 1, 5.60 : 1, 8.00 : 1 16.0 : 1, INF : 1	Specifies the degree of compression applied to the audio. The state in which no compression is applied is defined as "1."
Attack	0.0- 30 -100ms	Adjusts the time from when audio exceeding the threshold is input until when compression begins.
Release	30- 250 -5000ms	Adjusts the length of time until compression ends after audio falls below the threshold.
Makeup	-40- 0 -40dB	Adjusts the output volume level after applying the compressor.

Lim		
Threshold	-50- -6 -0dB	Specifies the level used as the threshold at which the limiter is applied. Compression is applied to audio that exceeds the threshold. The output volume is limited to below the threshold.
Output	-40- 0 -40dB	Adjusts the output volume level after applying the limiter.
Attack	0 -100ms	Adjusts the time from when audio exceeding the threshold is input until when compression begins.
Release	30- 500 -5000ms	Adjusts the length of time until compression ends after audio falls below the threshold.
Soft	OFF , ON	If this is "ON," reduces the distortion that can be noticeable when the limiter effect is applied to an extreme extent.

AUX 1 (*6) Adjusts the audio of the AUX 1 bus.		
AUX 1	OFF , ON	Turns the compressor or limiter on/off.

AUX 2 (*6) Adjusts the audio of the AUX 2 bus.		
AUX 2	OFF , ON	Turns the compressor or limiter on/off.

(*6) Other menu items are the same as for "MAIN."

15Band EQ Screen ([MENU] button → Audio <15Band EQ>)

Here you can make settings for the 15-band graphic equalizer. It lets you shape the character of the sound by boosting or cutting each of the 15 frequency regions into which the sound is divided.

Menu item	Value (bold text: default value)	Explanation
MAIN Adjusts the main output audio.		
MAIN	OFF, ON	Turns the equalizer on/off.
20	-15.0- 0.0 - +15.0dB	Boost/cut each frequency region.
40	-15.0- 0.0 - +15.0dB	
63	-15.0- 0.0 - +15.0dB	
100	-15.0- 0.0 - +15.0dB	
160	-15.0- 0.0 - +15.0dB	
250	-15.0- 0.0 - +15.0dB	
400	-15.0- 0.0 - +15.0dB	
630	-15.0- 0.0 - +15.0dB	
1k	-15.0- 0.0 - +15.0dB	
1.6k	-15.0- 0.0 - +15.0dB	
2.5k	-15.0- 0.0 - +15.0dB	
4k	-15.0- 0.0 - +15.0dB	
6.3k	-15.0- 0.0 - +15.0dB	
10k	-15.0- 0.0 - +15.0dB	
16k	-15.0- 0.0 - +15.0dB	
Flat	—	Sets the equalizer settings to flat (0.0 dB).

AUX 1 (*7) Adjusts the audio of the AUX 1 bus.		
AUX 1	OFF, ON	Turns the equalizer on/off.

AUX 2 (*7) Adjusts the audio of the AUX 2 bus.		
AUX 2	OFF, ON	Turns the equalizer on/off.

(*7) Other menu items are the same as for "MAIN."

Auto Mixing Screen ([MENU] button → Audio <Auto Mixing>)

Here you can make settings for the auto mixing function.

Menu item	Value (bold text: default value)	Explanation
Auto Mixing	OFF , ON	Turns the auto mixing function on/off. Auto mixing is a function that automatically controls the volume adjustments.
1-11/12	OFF , ON	Specifies whether Auto Mixing is applied (ON) or not applied (OFF).
Weight	0- 100	Specifies the weight level (the priority of volume distribution).

Video Follows Audio Screen ([MENU] button → Audio <Video Follows Audio>)

Here you can make settings for the Video Follows Audio function.

Menu item	Value (bold text: default value)	Explanation
Video Follows Audio	OFF , ON	Turns the Video Follows Audio function on/off. "Video follows audio" is a function that detects audio input from the mics, and switches to the desired video according to the volume. * If this function is on, the Audio Follow function (p. 27) automatically turns off and cannot be set.

Target

MIC 1-5, 7 (*8)	OFF , INPUT 1-4, STILL	Specifies the video that is output when audio is detected.
-----------------	-------------------------------	--

Threshold

MIC 1-5, 7 (*8)	-50- -16 -0dB	Specifies the reference level at which the Video Follows Audio function operates. When audio that exceeds this threshold is detected, the video is switched.
-----------------	----------------------	--

Mix	OFF , Input 1-4, Still	Specifies the video that is output when audio is detected in multiple mics. If this is "OFF," video is switched in the order in which audio is detected.
Silent	OFF , Input 1-4, Still	Specifies the video that is output when there is no audio input from any mic. If this is "OFF," the last-selected video continues to be output.
Time	0- 4.0 -30.0sec	Specifies the time after the video has switched until audio detection resumes.

(*8) The "MIC 5" and "MIC 7" settings are valid only when the Audio Ch. 5/6 or 7/8 screen (p. 39) "Input" setting is "MIC."

Reverb/Delay Screen ([MENU] button → Audio <Reverb/Delay>)

Here you can make settings for reverb and delay.

Menu item	Value (bold text: default value)	Explanation
Reverb Adds reverberation to the sound.		
Reverb	OFF , ON	Turns reverb on/off.
Level	0 -127	Specifies the amount of sound that is returned from the reverb (return level). This adjusts the depth of the overall reverb.
Time	0.1- 1.0 -5.0sec	Specifies the time until the reverberation is no longer heard.
Type	ROOM , STUDIO1, STUDIO2 HALL 1-3, PLATE	Specifies the reverb type.
Return	AUX1 OFF , ON	If this is "ON," the audio from the reverb is returned to the AUX 1 bus.
	AUX2 OFF , ON	If this is "ON," the audio from the reverb is returned to the AUX 2 bus.

Delay Compensates for timing discrepancies between the video and audio.

Main	0.0 -500.0ms	Adjusts the delay time of the main output audio.
AUX 1	0.0 -500.0ms	Adjusts the delay time of the AUX 1 bus audio.
AUX 2	0.0 -500.0ms	Adjusts the delay time of the AUX 2 bus audio.

Video

Video Input 1–4 Screen ([MENU] button → Video <1>-<4>)

When Input Assign=HDMI

Adjusts the video that is input from the HDMI IN connector.

Menu item	Value (bold text: default value)	Explanation
Scaling		
Type	Specifies the scaling type.	
	Full	Always displays the picture expanded to full screen, irrespective of the aspect ratio of the input video.
	Letterbox	Enlarges or reduces the incoming video to a full-screen view while keeping the aspect ratio unchanged.
	Crop	Enlarges or reduces the incoming video so that the output picture has no blank margins while keeping the aspect ratio unchanged. Video extending beyond the borders is cut off.
	Dot by Dot	Performs no scaling.
	Manual	Scale according to the "Size H" and "Size V" settings.
Size H	-1920- 0 - +1920 (*9)	Adjusts the horizontal size.
Size V	-1080- 0 - +1080 (*9)	Adjusts the vertical size.
Zoom	10.0- 100.0 -1000.0% (*9)	Adjusts the zoom ratio.
Position H	-1920- 0 - +1920	Adjusts the position in the horizontal direction.
Position V	-1080- 0 - +1080	Adjusts the position in the vertical direction.

(*9) The valid range of setting values depends on conditions such as the input/output format. In some cases, changing the value of a setting might not affect the video.

Color Correction		
Brightness	-64- 0 - +63	Adjusts the brightness.
Contrast	-64- 0 - +63	Adjusts the contrast.
Saturation	-64- 0 - +63	Adjusts the saturation.
Red	-64- 0 - +63	Adjusts the red level.
Green	-64- 0 - +63	Adjusts the green level.
Blue	-64- 0 - +63	Adjusts the blue level.
Color Space	Auto , RGB 0-255, RGB 16-235 YCC SD, YCC HD	Specifies the color space.
Flicker Filter	OFF , ON	If this is "ON," flickering is reduced.
EDID	Internal , 480/576i 4 : 3 480/576p 16 : 9, 480/576p 4 : 3 480/576p 16 : 9, 720p, 1080i 1080p, 1024 x 768, 1280 x 720 1280 x 800, 1280 x 1024 1400 x 1050, 1920 x 1080	Specifies the input format (EDID) of the HDMI IN connector.

When Input Assign=SDI or Composite

Adjusts the video that is input from the SDI IN connector or COMPOSITE IN connector.

Menu item	Value (bold text: default value)	Explanation
Scaling		
Type	Specifies the scaling type.	
	Full	Always displays the picture expanded to full screen, irrespective of the aspect ratio of the input video.
	Letterbox	Enlarges or reduces the incoming video to a full-screen view while keeping the aspect ratio unchanged.
	Crop	Enlarges or reduces the incoming video so that the output picture has no blank margins while keeping the aspect ratio unchanged. Video extending beyond the borders is cut off.
	Dot by Dot	Performs no scaling.
	Manual	Scale according to the "Size H" and "Size V" settings.
Size H	-1920- 0 - +1920 (*10)	Adjusts the horizontal size.
Size V	-1080- 0 - +1080 (*10)	Adjusts the vertical size.
Zoom	10.0- 100.0 -1000.0% (*10)	Adjusts the zoom ratio.
Position H	-1920- 0 - +1920	Adjusts the position in the horizontal direction.
Position V	-1080- 0 - +1080	Adjusts the position in the vertical direction.

(*10) The valid range of setting values depends on conditions such as the input/output format. In some cases, changing the value of a setting might not affect the video.

Menu List

Menu item	Value (bold text: default value)	Explanation
Color Correction		
Brightness	-64- 0 - +63	Adjusts the brightness.
Contrast	-64- 0 - +63	Adjusts the contrast.
Saturation	-64- 0 - +63	Adjusts the saturation.
Red	-64- 0 - +63	Adjusts the red level.
Green	-64- 0 - +63	Adjusts the green level.
Blue	-64- 0 - +63	Adjusts the blue level.

When Input Assign=RGB/Component

Adjusts the video that is input from the RGB/COMPONENT IN connectors.

Menu item	Value (bold text: default value)	Explanation
Scaling		
Type	Specifies the scaling type.	
	Full	Always displays the picture expanded to full screen, irrespective of the aspect ratio of the input video.
	Letterbox	Enlarges or reduces the incoming video to a full-screen view while keeping the aspect ratio unchanged.
	Crop	Enlarges or reduces the incoming video so that the output picture has no blank margins while keeping the aspect ratio unchanged. Video extending beyond the borders is cut off.
	Dot by Dot	Performs no scaling.
Manual	Scale according to the "Size H" and "Size V" settings.	
Size H	-1920- 0 - +1920 (*11)	Adjusts the horizontal size.
Size V	-1080- 0 - +1080 (*11)	Adjusts the vertical size.
Zoom	10.0- 100.0 -1000.0% (*11)	Adjusts the zoom ratio.
Position H	-1920- 0 - +1920	Adjusts the position in the horizontal direction.
Position V	-1080- 0 - +1080	Adjusts the position in the vertical direction.

(*11) The valid range of setting values depends on conditions such as the input/output format. In some cases, changing the value of a setting might not affect the video.

Color Correction		
Brightness	-64- 0 - +63	Adjusts the brightness.
Contrast	-64- 0 - +63	Adjusts the contrast.
Saturation	-64- 0 - +63	Adjusts the saturation.
Red	-64- 0 - +63	Adjusts the red level.
Green	-64- 0 - +63	Adjusts the green level.
Blue	-64- 0 - +63	Adjusts the blue level.

Color Space	Auto , RGB 0-255, RGB 16-235 YCC SD, YCC HD	Specifies the color space.
Flicker Filter	OFF , ON	If this is "ON," flickering is reduced.

Sampling		
Auto Sampling Execute	—	Automatically adjusts the display screen so that it is shown in the optimal position.
Position H	-1920- 0 - +1920	Adjusts the horizontal position of the display screen.
Position V	-1200- 0 - +1200	Adjusts the vertical position of the display screen.
Phase	-128- 0 - +127	Adjust this if flickering or blurring appears in the display screen.
Frequency	-128- 0 - +127	Adjust this if vertical stripes or blurring appears in the display screen.

EDID	Internal , 1024 x 768 1280 x 720, 1280 x 800 1280 x 1024, 1400 x 1050 1920x1080	Specifies the input format (EDIT) of the RGB/COMPONENT IN connector (for an RGB signal).
------	---	--

Video Input Still Screen ([MENU] button → Video <Still>)

Here you can make settings for still images loaded into the unit.

Menu item	Value (bold text: default value)	Explanation
Still		Touch to access the Still Select screen.
	1-4	Selects the still image that is assigned to the VIDEO INPUT SELECT [STILL] button. * When the [SELECT] button is lit red, you can also use the STILL/INPUT SOURCE [1]-[4] buttons to select a still image.
Position H	-1920- 0 - +1920	Adjusts the position in the horizontal direction.
Position V	-1080- 0 - +1080	Adjusts the position in the vertical direction.

Color Correction

Brightness	-64- 0 - +63	Adjusts the brightness.
Contrast	-64- 0 - +63	Adjusts the contrast.
Saturation	-64- 0 - +63	Adjusts the saturation.
Red	-64- 0 - +63	Adjusts the red level.
Green	-64- 0 - +63	Adjusts the green level.
Blue	-64- 0 - +63	Adjusts the blue level.

Video Output Screen ([MENU] button → Video <Output>)

Here you can adjust the output video.

Menu item	Value (bold text: default value)	Explanation
Format		Touch to access the Format Select screen.
	480/576i 4 : 3	Specifies the output format.
	480/576i 16 : 9	
	480/576p 4 : 3	
	480/576p 16 : 9	
	720p, 1080i, 1080p	
	1024 x 768	
	1280 x 720	
	1280 x 800	
	1280 x 1024	
1400 x 1050		
1920 x 1080		

Scaling

Zoom	10.0- 100.0 -1000.0%	Adjusts the zoom ratio.
Size H	-2000- 0 - +2000	Adjusts the horizontal size.
Size V	-2000- 0 - +2000	Adjusts the vertical size.
Position H	-1920- 0 - +1920	Adjusts the position in the horizontal direction.
Position V	-1080- 0 - +1080	Adjusts the position in the vertical direction.

Color Correction

Red	-64- 0 - +63	Adjusts the red level.
Green	-64- 0 - +63	Adjusts the green level.
Blue	-64- 0 - +63	Adjusts the blue level.
Brightness	-64- 0 - +63	Adjusts the brightness.
Contrast	-64- 0 - +63	Adjusts the contrast.
Saturation	-64- 0 - +63	Adjusts the saturation.

Output Bus

SDI	PGM	PGM , PVW, AUX	Specifies the video bus that is assigned to the SDI OUT (PGM, AUX) connector.
	AUX	PGM, PVW, AUX	
HDMI	PGM	PGM , PVW, AUX	Specifies the video bus that is assigned to the HDMI OUT (PGM, AUX) connector.
	AUX	PGM, PVW, AUX	
RGB/ COMPONENT	PGM	PGM , AUX	Specifies the video bus that is assigned to the RGB/COMPONENT OUT (PGM, AUX) connector.
	AUX	PGM, AUX	

Menu List

Menu item	Value (bold text: default value)	Explanation
AUX Bus Source	Selects the video that is sent to the AUX bus. * You can also use the AUX [1]–[PGM] buttons to select this.	
	Input 1–4	Video being input to Video Input 1–4
	PinP	Source video of the PinP layer
	PinP/KEY	Source video of the PinP/KEY layer
	PGM	Program video

Cropping		
Cropping	OFF , ON	Switches cropping on/off.
Size H	0– 128 –1920 (*12)	Adjusts the horizontal size. The video becomes smaller to match the size.
Size V	0– 64 –1080 (*12)	Adjusts the vertical size. The video becomes smaller to match the size.
Orientation		Specifies the orientation of the cropped video.

(*12) The valid range of setting values depends on conditions such as the input/output format. In some cases, changing the value of a setting might not affect the video.

Signal Type		
3G-SDI Mapping	Level A, Level B	Specifies the mapping structure of the 3G-SDI output.
HDMI PGM	HDMI , DVI-D	Specifies the type of signal that is output from each HDMI OUT connector.
HDMI AUX		
HDMI MULTI-VIEW		

Color Space		
HDMI PGM	RGB 0-255 , RGB 16-235 YCC 4:4:4, YCC 4:2:2	Specifies the color space that is output from each HDMI OUT connector.
HDMI AUX		
HDMI MULTI-VIEW		

Input Assign Screen (Press the [INPUT ASSIGN] button, or [MENU] button → Video <Input Assign>)		
Menu item	Value (bold text: default value)	Explanation
(Video Input 1)	SDI , HDMI, Composite	Select the video source (connector name) that is input to Video Input 1–4. * When the [SELECT] button is lit green, you can also use the STILL/INPUT SOURCE [1]–[4] buttons to select the video source.
(Video Input 2)	RGB/Component	
(Video Input 3)	SDI , HDMI	
(Video Input 4)		

Transition Setup Screen ([MENU] button → Video <Transition Setup>)

Here you can make settings for video switching.

Menu item	Value (bold text: default value)	Explanation
Time	0– 1.0 –4.0sec	Specifies the video transition time. * This can also be set by the [TIME] knob.

Wipe		
Pattern		Specifies the wipe pattern.
Direction	Normal , Reverse, N/R	Specifies the direction of wipe.

Border		
Use the following items to adjust the border added to the edge of the wipe area.		
Red	0– 128 –255	Adjusts the red level of the border color.
Green	0– 128 –255	Adjusts the green level of the border color.
Blue	0– 128 –255	Adjusts the blue level of the border color.
Width	0 –63	Adjusts the width of the border.

Composition Setup Screen ([MENU] button → Video <Composition Setup>)

Here you can make settings for video composition.

Menu item	Value (bold text: default value)	Explanation
Preview	PinP , PinP KEY , STILL KEY	Selects the layer for preview display.
Edit	PinP , PinP KEY, STILL KEY	Selects the layer for editing.
Source	—	When Edit=PinP: Displays PinP Source screen (p. 49). * You can also use the PinP [SOURCE] button to display the screen.
		When Edit=PinP KEY: Displays PinP/KEY Source screen (p. 49). * You can also use the PinP/KEY [SOURCE] button to display the screen.
		When Edit=STILL KEY: Displays STILL KEY Source screen (p. 49). * You can also use the STILL KEY [SOURCE] button to display the screen.
Detail	—	When Edit=PinP: Displays PinP screen (p. 50).
		When Edit=PinP KEY: Displays PinP/KEY screen (p. 51).
		When Edit=STILL KEY: Displays STILL KEY screen (p. 50).
Layer		Displays Composition Layer screen (p. 51).

PinP Source screen

Menu item	Value (bold text: default value)	Explanation
Source	SDI 1–4, ANALOG/HDMI 1 ANALOG/HDMI 2, HDMI 3 , HDMI 4	Selects the video source to which compositing is applied.
Detail	—	Displays PinP screen (p. 50).
Edit	—	Shows a detailed settings screen for the video source selected by "Source." * The settings of the detailed settings screen are in common with the settings of the Video Input screen. For details on the menu items, refer to "Video Input 1–4 Screen" (p. 45).

PinP/KEY Source screen

Menu item	Value (bold text: default value)	Explanation
Source	SDI 1–4, ANALOG/HDMI 1 ANALOG/HDMI 2, HDMI 3, HDMI 4	Selects the video source to which compositing is applied.
Detail	—	Displays PinP/KEY screen (p. 51).
Edit	—	Shows a detailed settings screen for the video source selected by "Source." * The settings of the detailed settings screen are in common with the settings of the Video Input screen. For details on the menu items, refer to "Video Input 1–4 Screen" (p. 45).

STILL KEY Source screen

* The settings of the STILL KEY Source screen are in common with the settings of the Video Input Still screen (p. 47).

Menu item	Value (bold text: default value)	Explanation
Still		Touch to access the Still Select screen.
	1–4	Selects the source image to which compositing is applied. * When the [SELECT] button is lit red, you can also use the STILL/INPUT SOURCE [1]–[4] buttons to select a source image.
Position H	-1920– 0 – +1920	Adjusts the horizontal position.
Position V	-1080– 0 – +1080	Adjusts the vertical position.
Detail	—	Displays the STILL KEY screen (p. 50).

Color Correction

Brightness	-64– 0 – +63	Adjusts the brightness.
Contrast	-64– 0 – +63	Adjusts the contrast.
Saturation	-64– 0 – +63	Adjusts the saturation.
Red	-64– 0 – +63	Adjusts the red level.
Green	-64– 0 – +63	Adjusts the green level.
Blue	-64– 0 – +63	Adjusts the blue level.

PinP screen

Menu item	Value (bold text: default value)	Explanation
PinP	OFF, ON	Enables (ON) or disables (OFF) PinP settings.
Size	10.0- 25.0 -100.0%	Adjusts the size (zoom) of the inset screen.
Position H	-100.0- -30.0 - +100.0%	Adjusts the horizontal position of the inset screen.
Position V	-100.0- -25.0 - +100.0%	Adjusts the vertical position of the inset screen.

Cropping		
Cropping	Original , 4 : 3, 16 : 9, Manual	Specifies the type when cropping the inset screen. If "Manual" is selected, cropping is done according to the "Size H" and "Size V" settings.
Size H	-2000- 0 - +2000	Adjusts the horizontal size.
Size V	-2000- 0 - +2000	Adjusts the vertical size.

View		
Use the following items to adjust the video that is shown in the inset screen.		
Zoom	100.0 -1000.0%	Adjusts the zoom.
Position H	-1920- 0 - +1920	Adjusts the horizontal position.
Position V	-1080- 0 - +1080	Adjusts the vertical position.

Border		
Use the following items to adjust the border that is added to the inset screen.		
Red	0- 128 -255	Adjusts the red level of the border color.
Green	0- 128 -255	Adjusts the green level of the border color.
Blue	0- 128 -255	Adjusts the blue level of the border color.
Width	0- 128 -255	Adjusts the width of the border.

STILL KEY screen

Menu item	Value (bold text: default value)	Explanation
KEY	OFF, ON	Enables (ON) or disables (OFF) the key settings.
Type	Specifies the key type (extraction color) used during key composition.	
	Lumi White	Makes white portions transparent according to brightness.
	Lumi Black	Makes black portions transparent according to brightness.
	Chroma Blue	Uses a color threshold to make blue transparent.
	Chroma Green	Uses a color threshold to make green transparent.
Level	0- 32 -255	Adjusts the degree of extraction (transparency) for the key.
Gain	0 -255	Adjusts the degree of edge blur (semi-transmissive region) for the key.

Hue (*13)		
Width	-128- 0 - +127	Adjusts the hue width for the key color.
Fine	-128- 0 - +127	Adjusts the center position of the hue for the key color.

Saturation (*13)		
Width	-128- 0 - +127	Adjusts the saturation width for the key color.
Fine	0 -255	Adjusts the center position of saturation for the key color.

(*13) This is valid when "Type" is "Chroma Blue" or "Chroma Green."

PinP/KEY screen

PinP

Menu item	Value (bold text: default value)	Explanation
PinP	OFF, ON	Enables (ON) or disables (OFF) PinP settings.
Size	10.0- 25.0 -100.0%	Adjusts the size (zoom) of the inset screen.
Position H	-100.0- -30.0 - +100.0%	Adjusts the horizontal position of the inset screen.
Position V	-100.0- -25.0 - +100.0%	Adjusts the vertical position of the inset screen.

Cropping

Cropping	Original , 4 : 3, 16 : 9, Manual	Specifies the type when cropping the inset screen. If "Manual" is selected, cropping is done according to the "Size H" and "Size V" settings.
Size H	-2000- 0 - +2000	Adjusts the horizontal size.
Size V	-2000- 0 - +2000	Adjusts the vertical size.

View

Use the following items to adjust the video that is shown in the inset screen.

Zoom	100.0 -1000.0%	Adjusts the zoom.
Position H	-1920- 0 - +1920	Adjusts the horizontal position.
Position V	-1080- 0 - +1080	Adjusts the vertical position.

Border

Use the following items to adjust the border that is added to the inset screen.

Red	0- 128 -255	Adjusts the red level of the border color.
Green	0- 128 -255	Adjusts the green level of the border color.
Blue	0- 128 -255	Adjusts the blue level of the border color.
Width	0- 5 -63	Adjusts the width of the border.

KEY

Menu item	Value (bold text: default value)	Explanation
KEY	OFF, ON	Enables (ON) or disables (OFF) the key settings.
Type	Specifies the key type (extraction color) used during key composition.	
	Lumi White	Makes white portions transparent according to brightness.
	Lumi Black	Makes black portions transparent according to brightness.
	Chroma Blue	Uses a color threshold to make blue transparent.
	Chroma Green	Uses a color threshold to make green transparent.
Level	0- 32 -255	Adjusts the degree of extraction (transparency) for the key.
Gain	0 -255	Adjusts the degree of edge blur (semi-transmissive region) for the key.

Hue (*14)

Width	-128- 0 - +127	Adjusts the hue width for the key color.
Fine	-128- 0 - +127	Adjusts the center position of the hue for the key color.

Saturation (*14)

Width	-128- 0 - +127	Adjusts the saturation width for the key color.
Fine	0 -255	Adjusts the center position of saturation for the key color.

(*14) This is valid when "Type" is "Chroma Blue" or "Chroma Green."

Composition Layer screen

Menu item	Value (bold text: default value)	Explanation
Layer		
PinP	Bottom , Middle, Top	Specify the order of layering. For details on operation, refer to "Changing the order of layers" (p. 18).
PinP/KEY	Bottom, Middle , Top	
STILL KEY	Bottom, Middle, Top	

Test Pattern screen (Press the [MENU] button → touch Video <Test Pattern>)

Menu item	Value (bold text: default value)	Explanation
Test Pattern	OFF , 75% Color Bar, 100% Color Bar Ramp, Step, Hatch, Frame	Specifies the test pattern.
Test Tone	OFF , ON	Turns the test tone on/off.

Still Load/Delete screen ([MENU] button → Video <Still Load/Delete>)

Here you can load a still image from a USB flash drive, or delete a loaded still image.

Menu item	Value (bold text: default value)	Explanation
Load	—	Shows a list of the still images saved in the root directory of the USB flash drive. You can select a still image and load it into the unit. Formats supported for loading
		Format Windows Bitmap file (.bmp), 24-bit color, uncompressed
		Resolution Maximum 1920 x 1080 pixels
		File name Up to eight single-byte alphanumeric characters * The extension ".bmp" must be added.
		* The still image is temporarily saved in the unit. When you turn off the power, the still image is deleted. * You can make the previously-loaded still image be automatically loaded when this unit starts. Save the same file in the root directory of the USB flash drive, and start this unit with the USB flash drive connected.
Delete	—	Deletes the still image that is loaded into the unit.
Reload	—	Reloads a still image from the USB flash drive.

Capture/Freeze/Logo Screen ([MENU] button → Video <Capture/Freeze/Logo>)

Here you can specify the function of the [FREEZE/USER LOGO] button, and capture a still image from the video output.

Menu item	Value (bold text: default value)	Explanation
Freeze/User Logo		
Mode		Specifies the function of the [FREEZE/USER LOGO] button.
	Freeze	Temporarily pauses the program output video (freeze function).
	User Logo	Temporarily stops the program output, and outputs the specified still image.
Still		Touch to access the Still Select screen.
	1-4	Selects the still image that is assigned to the [FREEZE/USER LOGO] button.
Output Capture		
Source	PGM , AUX	Specifies the video bus on which still image capture is used.
Still		Touch to access the Still Select screen.
	1-4	Specifies the save-destination for the captured still image. * The still image is temporarily saved in the unit. When you turn off the power, the still image is deleted.
Execute	—	Capture a still image from the output video.

System

USB Streaming Screen ([MENU] button → < ▶ > → System <USB Streaming>)

Here you can make settings for video and audio that are output via USB.

Menu item	Value (bold text: default value)	Explanation
Audio		
Level	-INF- 0.0 - +12.0dB	Adjusts the volume of the USB output.
Audio Bus	MAIN , AUX 1, AUX 2	Specifies the audio bus that is assigned to the USB STREAMING port.
Delay	0.0 -500.0ms	Adjusts the delay time for USB output audio. Use this to correct any timing discrepancy between the video and the audio.
Video		
Resolution	480p, 720p, 1080p	Specifies the output format of the USB STREAMING port.
Frame Rate	59.94Hz, 29.97Hz (*15) 50Hz, 25Hz (*16)	Specifies the frame rate of the USB STREAMING port.
Video Bus	PGM , AUX	Specifies the video bus that is assigned to the USB STREAMING port.
Connection	(USB2 .0, USB3 .0)	Indicates whether the connection uses USB 2.0 or USB 3.0. If not connected to a computer, this indicates "NC."
Dropped Frames	—	Normally this indicates "0." If the number is increasing, video transmission is not fast enough. Either use "Resolution" to lower the output format, or use "Frame Rate" to lower the frame rate.
Reset	—	Attempts to reconnect with the computer. Execute this if a connection fails to be established, or if the video is disordered.

(*15) This is the frame rate used when the Setup screen (p. 54) parameter "Frame Rate" is set to "59.94Hz."

(*16) This is the frame rate used when the Setup screen (p. 54) parameter "Frame Rate" is set to "50Hz."

Memory Screen ([MENU] button → < ▶ > → System <Memory>)

Here you can save the current settings to internal memory or to a USB flash drive, and recall saved settings.

Menu item	Value (bold text: default value)	Explanation
Recall	—	Recalls a memory. Touch <Recall> to make it light green, and then touch a "Memory No." number to recall a memory.
Store	—	Saves the current settings to a memory. Touch <Store> to make it light red, and then touch a "Memory No." number to save the settings to a memory. * The following settings are common to the unit (one set for the entire unit), and therefore are not saved in memory. <ul style="list-style-type: none"> • Menu items of the Setup screen (p. 54), Memory screen, and Network (p. 55) • "Test Pattern" and "Test Tone" settings of the Test Pattern screen (p. 52). The unit always starts with these "OFF." • The state of the [OUTPUT FADE] button. Always unlit at startup.
Memory No.	1-8	Specifies the memory number for saving or recalling settings.
Start Up	Specifies the settings loaded at startup.	
	LAST	Restores the state that was in effect immediately before the power was turned off (Last Memory feature). The current settings are written to the last memory when 10 seconds elapse without any operation being performed or when you close a menu.
Priority	1-8	Recall the settings of the specified memory number.
	PANEL	Specifies whether fader and knob settings are applied to the values when a memory is recalled or when the unit starts. The values corresponding to the fader and knob current positions are applied.
	MEMORY	The values saved in the memory are applied. The positions of the faders and knobs might differ from the actual values.

USB Memory

Load	—	Shows a list of the setting files (.V50) that are on the USB flash drive. You can select a setting file and load the settings into the unit. The current settings are overwritten.
Save	—	Shows a list of the setting files (.V50) that are on the USB flash drive. You can select a setting file and then save the current settings by overwriting them onto the selected file.
Save As	—	Saves the current settings to the USB flash drive as a new file (.V50). Content that is not saved to the file <ul style="list-style-type: none"> • "Test Pattern" and "Test Tone" settings of the Test Pattern screen (p. 52). The unit always starts with these "OFF." • The still images loaded into the unit. Only the file names of the still images are saved. • The state of the [OUTPUT FADE] button. Always unlit at startup.
Format	—	Formats the USB flash drive.

Setup Screen ([MENU] button → < ▶ > → System <Setup>)

Here you can make system-related settings.

Menu item	Value (bold text: default value)	Explanation
HDCP	OFF , ON	Specifies whether HDCP is enabled (ON) or disabled (OFF). When set to "ON," copyright-protected (HDCP) video can be input. HDCP is also added to the video that is output.
NTSC Setup	OIRE , 7.5IRE	Specifies the NTSC setup level.
Frame Rate	59.94Hz, 50Hz	Specifies the frame rate.
Field Sync	OFF, ON	If this is "ON," the fields are automatically matched between input and output of the interlaced signal. * This improves the image quality, but there will be more delay between input and output.

Reference

Reference	Specifies the reference clock.	
	Internal	Specifies the reference clock as the internal clock of the unit.
	SDI 1	Specifies the reference clock as the signal that is input from the SDI IN 1 connector. The VSYNC (vertical synchronization signal) that is output by this unit will synchronize to the VSYNC being input via SDI.
Clock Adj.	-1920- 0 - +1920	Adjusts the horizontal phase when "Reference" is "SDI 1." Adjust this if the output is horizontally skewed in comparison to another device that is operating on the same clock.
Line Adj.	-1080- 0 - +1080	Adjusts the vertical phase when "Reference" is "SDI 1." Adjust this if the output is vertically skewed in comparison to another device that is operating on the same clock, or if the field is skewed.

Panel Lock

Panel Lock	Enables or disables locking of the operating panel. When the operating panel is locked, the [MENU] button is lit.	
	OFF	Unlocks the operating panel.
	Part	Buttons and knobs other than the following are locked. <ul style="list-style-type: none"> Unaffected by panel lock: [MENU] [EXIT], [ENTER] buttons, VIDEO INPUT SELECT [1]-[STILL] buttons [VALUE] [PHONES] knobs, faders, touch panel
	All	Buttons, knobs, and faders other than the following are locked. <ul style="list-style-type: none"> Unaffected by panel lock: [MENU] [EXIT] [ENTER] buttons, [VALUE] [PHONES] knobs, touch panel

232C

232C	OFF, ON	If this is "ON," RS-232C commands can be transmitted and received.
Rate	9600, 38400	Specifies the communication speed (bps) of the RS-232C connector.

Output Fade

Color	Black , White	Specifies the background color (black, white) used when fading-in/out the program output video.
-------	----------------------	---

Touch Panel

Label	—	Displays the Label screen (p. 54). You can rename the input/output video and still image labels (up to eight characters) that are shown in the monitor.
Video Input Select	OFF, ON	If this is "ON," video switching by touching the monitor is enabled.
Mat Transparency	0- 2 -7	Adjusts the degree of transparency for the background of the menu screen.
Dimmer	0- 7	Adjusts the brightness when the buttons or indicators are lit. * Even with a setting of "0," the buttons and indicators do not go completely dark.
Version	—	Displays the version of the system program.
Factory Reset	—	Returns the unit to its factory defaults.

Label screen

Menu item	Value (bold text: default value)	Explanation
MULTI-VIEW Label	OFF, ON	If this is "ON," labels and tally border are shown in the multi-view that is output from the MULTI-VIEW connector.

Network

LAN Screen

([MENU] button → < ▶ > → Network <LAN>)

Here you can make network-related settings.

Menu item	Value (bold text: default value)	Explanation
Status	—	Displays the connection status.
IP Address	—	Displays the IP address.
MAC Address	—	Displays the MAC address.
Subnet Mask	—	Displays the subnet mask.

Setup	—	Accesses the LAN setup screen.	
	Menu item	Value	Explanation
	Config	MANUAL, DHCP	Specifies whether the IP address and subnet mask are obtained automatically (DHCP) or set manually (MANUAL).
	IP Address (*17)	192.168.2.1	Specifies the IP address as appropriate for the network to which the unit is connected.
Subnet Mask (*17)	255.255.255.0	Specifies the subnet mask as appropriate for the network to which the unit is connected.	

(*17) This is valid if "Config" is "MANUAL."

Camera Screen

([MENU] button → < ▶ > → Network <Camera Control>)

Here you can make settings related to remote control of the cameras.

Menu item	Value (bold text: default value)	Explanation
Camera	1–6	Selects the camera to be controlled.
All Camera Recall	Specifies how presets are recalled.	
	OFF	Recall presets from the camera that is being controlled.
	ON	Simultaneously recall presets from all cameras (CAMERA 1–6).
Store	—	Stores the camera settings to a preset. Touch <Store> to make it light red, and then touch a "Camera Preset" number to register the settings in a preset. * Presets are saved in the camera itself.
Camera Preset	1–8	Recall presets.
Setup	—	Displays the Camera Setup screen (p. 56).

Positioner	Adjust the horizontal/vertical position of the camera.	
◀	—	While you touch the item, the camera faces left.
▶	—	While you touch the item, the camera faces right.
▲	—	While you touch the item, the camera faces up.
▼	—	While you touch the item, the camera faces down.
Speed	1– 12 –24	Adjusts the speed at which the camera changes direction.

Zoom	Adjusts the camera's zoom position.		
Fast	Wide	—	While you touch the item, the camera zooms-out at high speed.
	Tele	—	While you touch the item, the camera zooms-in at high speed.
Slow	Wide	—	While you touch the item, the camera zooms-out at low speed.
	Tele	—	While you touch the item, the camera zooms-in at low speed.
Reset	—	Resets the zoom position.	

Focus	Adjusts the focal point of the camera.	
Near	—	While you touch the item, the focus moves closer.
Far	—	While you touch the item, the focal point moves farther away.
Auto	—	If this is "ON," the focal point is set automatically.

Exposure		
Auto	—	Specifies the exposure mode (auto/manual). If this is on, auto mode is enabled.

TALLY		
Ch	1–4	Specifies the number of the video input to which the camera's video is being input. When the camera video from this unit is the program output, the camera's tally light is lit.

Camera Setup screen

Menu item	Value (bold text: default value)	Explanation
Camera ID	1-6	Selects the camera to be controlled.
Protocol	N/A, JVC, Panasonic	Specifies the camera's protocol.
Login Name	—	If the "Protocol" is "JVC," touch this to access a screen where you can enter a login name. Enter the log-in name needed to connect with the camera .
Password	—	If the "Protocol" is "JVC," touch this to access a screen where you can enter a password. Enter the password needed to connect with the camera
IP Address	Camera ID 1: 192.168.2.101 Camera ID 2: 192.168.2.102 Camera ID 3: 192.168.2.103 Camera ID 4: 192.168.2.104 Camera ID 5: 192.168.2.105 Camera ID 6: 192.168.2.106	Input the camera's IP address.

LAN/RS-232C Command Reference

This unit support two types of remote-interface communication: LAN and RS-232C.

Using the LAN port or RS-232C connector to send specific commands to this unit from a controlling device lets you operate this unit remotely.

LAN Interface

This uses the CONTROL port on this unit.

You use Telnet to operate this unit remotely over a LAN (TCP/IP protocol).

Communication standards

Port	LAN port
Protocol	TCP
Port number	8023

Specifying the unit's network settings

- [MENU] button → touch <▶> → System <LAN> → <Setup>.
- Touch a menu item to select it, and make network settings.

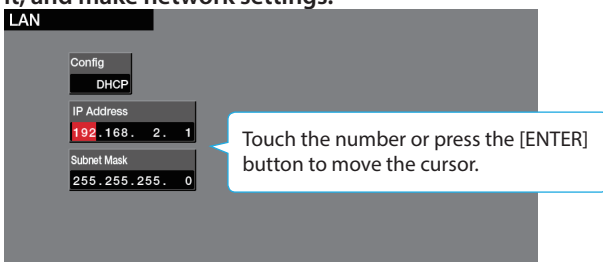

Menu item	Explanation
Config	Specifies whether the IP address and subnet mask are obtained automatically (DHCP) or set manually (MANUAL).
IP Address	When "Config" is "MANUAL" Specifies the IP address as appropriate for the network to which the unit is connected.
Subnet Mask	When "Config" is "MANUAL" Specifies the subnet mask as appropriate for the network to which the unit is connected.

- Press the [MENU] button to close the menu screen.

Verifying the LAN information

- [MENU] button → touch <▶> → System <LAN>. The LAN screen shows the following information.

Indication	Explanation
Status	Displays the connection status.
IP Address	Displays the IP address.
MAC Address	Displays the subnet mask.
Subnet Mask	Displays the MAC address.

- Press the [MENU] button to close the menu screen.

RS-232C Interface

RS-232C connector pin layout

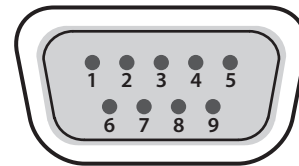

DB-9 type (male)

Pin assignments

Pin No.	Signal name
1	N.C.
2	RXD
3	TXD
4	DTR
5	GND
6	DSR
7	RTS
8	CTS
9	N.C.

Communication standards

Communication method	Synchronous (asynchronous), full-duplex
Communication speed	9,600/38,400 bps
Parity	none
Data length	8 bits
Stop bit	1 bit
Code set	ASCII

Cable wiring diagram

Use an RS-232C crossover cable to connect this unit and the controller (an RS-232C-compatible computer or other device).

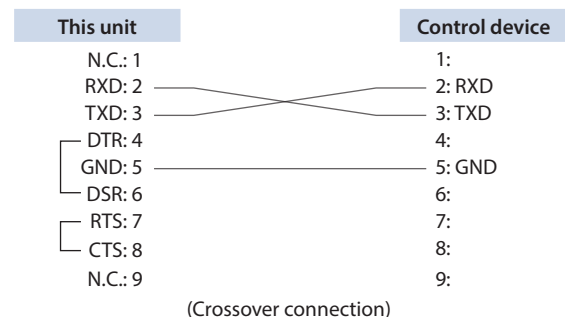

* The connections between 4 and 6 and between 7 and 8 are inside this unit.

Command Format

Commands are formatted using the configuration shown below. Commands are all in ASCII code.

stx	Command code	:	Parameter	,	Parameter	;
-----	--------------	---	-----------	---	-----------	---

stx	ASCII code "02H" is a control code indicating the start of a command. "H" indicates that it is a hexadecimal value.
Command code	This specifies the command type (three single-byte alphanumeric characters).
Parameter	This is appended to a command that requires one or more parameter. The command and the parameter portion are separated by a ":" (colon). When there are multiple parameters, they are each separated by "," (comma) characters.
;	This is the code that this unit recognizes as the end of a command.

* The codes of stx (02H) and ack (06H) are the control codes.

List of Commands

* When sending a sequence of commands to this unit from a controller, after each one, be sure to verify that an "ACK" response is returned before sending the next command.

Item	Sent command	Response command	Parameter
Select video input	stxPGM:a;	ack	a: 0 (INPUT 1), 1 (INPUT 2), 2 (INPUT 3), 3 (INPUT 4), 4 (STILL)
Select transition effect	stxTRS:a;	ack	a: 0 (CUT), 1 (MIX), 2 (WIPE)
Set video transition time	stxTIM:a;	ack	a: 0–40 (0.0–4.0 sec)
Set the [PinP] button on/off	stxPIP:a;	ack	a: 0 (OFF), 1 (ON)
Set the [PinP/KEY] button on/off	stxPKY:a;	ack	a: 0 (OFF), 1 (ON)
Set the [STILL KEY] button on/off	stxSKY:a;	ack	a: 0 (OFF), 1 (ON)
Set the [OUTPUT FADE] button on/off	stxFDE:a;	ack	a: 0 (OFF), 1 (ON)
Set the [FREEZE/USER LOGO] button on/off	stxULF:a;	ack	a: 0 (OFF), 1 (ON)
Adjust volume of audio channel 1	stxLM1:a;	ack	a: 0 (-Inf dB)–127 (+10 dB)
Adjust volume of audio channel 2	stxLM2:a;	ack	a: 0 (-Inf dB)–127 (+10 dB)
Adjust volume of audio channel 3	stxLM3:a;	ack	a: 0 (-Inf dB)–127 (+10 dB)
Adjust volume of audio channel 4	stxLM4:a;	ack	a: 0 (-Inf dB)–127 (+10 dB)
Adjust volume of audio channels 5/6	stxLS1:a;	ack	a: 0 (-Inf dB)–127 (+10 dB)
Adjust volume of audio channels 7/8	stxLS2:a;	ack	a: 0 (-Inf dB)–127 (+10 dB)
Adjust volume of audio channels 9/10	stxLS3:a;	ack	a: 0 (-Inf dB)–127 (+10 dB)
Adjust volume of audio channels 11/12	stxLS4:a;	ack	a: 0 (-Inf dB)–127 (+10 dB)
Adjust volume of main output	stxLMN:a;	ack	a: 0 (-Inf dB)–127 (+10 dB)
Recall memory	stxMEM:a;	ack	a: 0 (Memory 1)–7 (Memory 8)
Select video for AUX bus	stxAUX:a;	ack	a: 0 (INPUT 1), 1 (INPUT 2), 2 (INPUT 3), 3 (INPUT 4), 4 (STILL), 4 (PinP) 5 (PinP/KEY), 6 (PGM)
Select source video for video input	stxVIS:a,b;	ack	a: 0 (INPUT 1), 1 (INPUT 2), 2 (INPUT 3), 3 (INPUT 4), 4 (STILL) b: 0 (SDI), 1 (HDMI), 2 (COMPOSITE), 3 (RGB/COMPONENT) * When a=2 (INPUT 3) or 3 (INPUT 4), you can select 0 (SDI) and 1 (HDMI) only.
Select still image of the [STILL] button	stxSTS:a;	ack	a: 0 (STILL 1), 1 (STILL 2), 2 (STILL 3), 3 (STILL 4)
Select source video for PinP	stxPIS:a;	ack	a: 0 (SDI 1), 1 (SDI 2), 2 (SDI 3), 3 (SDI 4), 4 (HDMI 1), 5 (HDMI 2), 6 (HDMI 3) 7 (HDM 4), 8 (COMPOSITE 1), 9 (COMPOSITE 2), 10 (RGB/COMPONENT 1) 11 (RGB/COMPONENT 2)
Select source video for PinP/KEY	stxPKS:a;	ack	a: 0 (SDI 1), 1 (SDI 2), 2 (SDI 3), 3 (SDI 4), 4 (HDMI 1), 5 (HDMI 2), 6 (HDMI 3) 7 (HDM 4), 8 (COMPOSITE 1), 9 (COMPOSITE 2), 10 (RGB/COMPONENT 1) 11 (RGB/COMPONENT 2)
Select source image for STILL KEY	stxSKS:a;	ack	a: 0 (STILL 1), 1 (STILL 2), 2 (STILL 3), 3 (STILL 4)
Recall preset memory on remote camera	stxCML:a,b;	ack	a: 0 (CAMERA 1)–5 (CAMERA 6) b: 0 (Memory 1)–7 (Memory 8)
Acquire status of the VIDEO INPUT SELECT buttons	stxQPG;	stxQPG:a;	a: 0 (INPUT 1), 1 (INPUT 2), 2 (INPUT 3), 3 (INPUT 4), 4 (STILL)
Enable spontaneously sending status of the VIDEO INPUT SELECT buttons	stxCPG:a;	ack	a: 0 (OFF), 1 (ON)
Reset USB connection	stxUVR;	ack	
Acquire status of USB streaming	stxUVQ;	stxUVS:a,b;	a: 0 (unconnected), 1 (USB 2.0), 2 (USB 3.0) b: Number of dropped frames
Acquire status of the unit	stxACS;	ack	
Version information	stxVER;	stxVER:a,b;	a: VR-50HDMK2 Product name b: Version number The version info is ASCII text strings.

Commands spontaneously sent from this unit

Item	Sent command	Response command	Parameter
Send status of the VIDEO INPUT SELECT buttons	stxPGM:a;	stxQPG:a;	a: 0 (INPUT 1), 1 (INPUT 2), 2 (INPUT 3), 3 (INPUT 4), 4 (STILL) * This is enabled when the unit receives the command "stxCPG: 1;"
Error detected	stxTRS:a;	stxERR:a;	a: 0 (syntax error) The received command contains an error. 4 (invalid) This has no effect because it is controlled by another setting. 5 (out of range error) An argument of the received command is out of range.

Appendices

Troubleshooting

If you suspect a malfunction, please check the following points. If this does not resolve the problem, contact a nearby Roland Service Center.

Problem	Items to check	Action	Page
Video-related problems			
No picture is input.	Could you be inputting copy-protected (HDCP) video?	If you want to input copy-protected (HDCP) video, set "HDCP" to "ON."	p. 11
Video input from a computer is distorted.	If video is being input from a computer, the image can sometimes be skewed, flickering, or otherwise distorted.	This is a phenomenon called "tearing," and is not a malfunction.	—
No video appears.	Could the [OUTPUT FADE] button be lit?	If the [OUTPUT FADE] button is lit, the program output video fades-out to a black screen. To output the program video, press the [OUTPUT FADE] button to make it go dark.	p. 16
	Could "HDCP" be "ON"?	When "HDCP" is set to "ON," video respectively is output only from the HDMI output connectors.	p. 11
	Does the output destination display support copy protection (HDCP)?	If you are outputting copy-protected (HDCP) video, and a display that does not support HDCP is connected, the video might not be shown or might be incorrect. Connect a display that supports HDCP.	p. 11
"Snowy"-noise video is shown.	It might be that the HDMI signal is not being correctly transmitted or received.	Reconnect the HDMI cable.	—
Color is wrong.	Do the color space settings of the input/output destination device and the unit match?	Change the settings for the following menu items. <ul style="list-style-type: none"> • Video Input (HDMI) "Color Space" • Video Input (RGB/Component) "Color Space" • Video Output (HDMI) "Color Space" 	p. 45 p. 46 p. 48
		Depending on the device, the color space might be linked with the DVI/HDMI selection or the selection of format. If so, changing the color space of the output-destination device might solve the problem.	—
An edge of the video shown on a display is cut off.	Are the display's settings correct?	Depending on the display, it might overscan automatically. Change the settings of the device.	—
The monitor (LCD screen) has a missing dot.	The unit's monitor (LCD screen) is made using precision technology, but in rare cases, it may exhibit a missing pixel or a pixel that remains constantly lighted.	This is not a malfunction.	
Can't connect via USB 3.0. Video is jerky.	Could you be connecting via an extension cable or a USB hub?	If you connect via an extension cable or a USB hub, the computer might not recognize this unit. We recommend that you connect this unit directly to your computer.	—
	—	Use the [MENU] button → System <USB Streaming> → touch <Reset> to try reconnecting the computer and the unit.	—
	Could you be using a USB 2.0 cable to connect the unit and the computer?	If you're outputting HD video via USB, use a USB 3.0 cable to connect the unit and the computer.	—
Can't load a still image.	Could the still image be a format or resolution that the unit does not support?	A still image of an unsupported format or resolution is not detected. Check the formats and resolutions that can be loaded.	p. 15
	Is the file name of the still image assigned correctly?	If the file's name is not correct, it is not recognized. The file name must be no more than eight single-byte characters. Also, the file name extension "bmp" must be added.	
Audio-related problems			
No audio is output. Audio volume is low.	Is the volume turned down on the unit?	Adjust each input to the appropriate volume. Also raise the output volume.	p. 25
	Could the volume of the USB output be lowered?	The USB output volume (the volume for streaming) can be adjusted individually. Use the [USB AUDIO] knob to adjust the main output volume.	p. 32
	Could the sound be muted (silenced)?	Cancel muting for the input/output audio.	p. 28
	Is there audio for which the solo function is turned on?	Only the soloed audio is heard from the headphones. Cancel the solo function.	p. 28
	Is a condenser mic connected?	If a condenser mic or other device requiring a phantom power supply is connected, use the [MENU] button → Audio <1>-<4> → set "+48V" to "ON."	p. 6
Other Problems			
Can't use a USB flash drive.	Has the USB flash drive been formatted by the unit?	A USB flash drive that was not formatted by the unit is not recognized. When using a USB flash drive for the first time, you must format it on this unit.	p. 35
The unit gets extraordinary hot	Are you using an external power supply whose voltage is not within DC 12 V to 16 V?	Stop using the external power source and use the included AC adaptor.	p. 7

Main Specifications

Roland VR-50HD MK II: Multi-format Video Mixer

Video			
Video Processing	4:4:4 (RGB), 10-bit		
	4:4:4 (Y/Pb/Pr), 10-bit		
Input Connectors	SDI IN 1–4 connectors	BNC type x 4 * Conforms to SMPTE 424M (SMPTE 425M-AB), 292M, 259M-C.	
	HDMI IN 1–4 connectors	HDMI type A x 4 * HDCP supported	
	RGB/COMPONENT IN 1–2 connectors	HD DB-15 type x 2	
	COMPOSITE IN 1–2 connectors	BNC type x 2	
Output Connectors	SDI OUT	PGM AUX	
	HDMI OUT	PGM	
		AUX	
		MULTI-VIEW	
RGB/COMPONENT OUT	PGM AUX		
Input/Output Level and Impedance	Composite (COMPOSITE IN)	1.0 Vp-p 75 Ω	
	Analog RGB (RGB/COMPONENT IN, RGM/COMPONENT OUT)	0.7 Vp-p 75 Ω (H, V: 5 VTTL)	
	Analog HD (RGB/COMPONENT IN, RGB/COMPONENT OUT)	1.0 Vp-p 75 Ω (Sync-signal: Bi-Level/Tri-Level)	
Video Formats (*1)	SDI (SDI IN, SDI OUT) 480/59.94i, 576/50i, 720/59.94p, 720/50p, 1080/59.94i, 1080/50i, 1080/59.94p, 1080/50p * Conforms to SMPTE 274M, SMPTE 296M, ITU-R BT.601-5.		
	HDMI (HDMI IN, HDMI OUT) (*2) 480/59.94i, 576/50i, 480/59.94p, 576/50p, 720/59.94p, 720/50p, 1080/59.94i, 1080/50i, 1080/59.94p, 1080/50p, 1024 x 768/60 Hz (*3) 1280 x 720/60 Hz, 1280 x 800/60 Hz (*3), 1280 x 1024/60 Hz (*3), 1400 x 1050/60 Hz, 1920 x 1080/60 Hz * Conforms to CEA-861-E or VESA DMT Version 1.0 Revision 11.		
	HDMI (HDMI OUT MULTI-VIEW) 1080/59.94p * Conforms to CEA-861-E or VESA DMT Version 1.0 Revision 11.		
	Component (RGB/COMPONENT IN, RGB COMPONENT OUT) (*2) 480/59.94i, 576/50i, 480/59.94p, 576/50p, 720/59.94p, 720/50p, 1080/59.94i, 1080/50i, 1080/59.94p, 1080/50p * Conforms to CEA-861-E or VESA DMT Version 1.0 Revision 11.		
	RGB (RGB/COMPONENT IN, RGB/COMPONENT OUT) (*2) 1024 x 768/60 Hz (*3), 1280 x 720/60 Hz, 1280 x 800/60 Hz (*3), 1280 x 1024/60 Hz (*3), 1400 x 1050/60 Hz, 1920 x 1080/60 Hz * Conforms to CEA-861-E or VESA DMT Version 1.0 Revision 11.		
	Composite (COMPOSITE IN) NTSC, PAL * Conforms to ITU-R BT.601-5.		
	USB-VIDEO (USB STREAMING) 480/29.97p, 576/25p, 480/59.94p, 576/50p, 720/29.97p, 720/25p, 720/59.94p, 720/50p, 1080/29.97p, 1080/25p, 1080/59.94p, 1080/50p		
	Still Image (*4)	Format	Windows Bitmap file (.bmp), 24-bit color, uncompressed
		Maximum size	1920 x 1080 pixels
	Effects	Transition	Mix, Cut, Wipe (9 patterns)
Composition		PinP, Chroma key, Luminance key	
Others		Output fade, Output freeze, User logo	

(*1) The video signal frame rate must match the unit's frame rate setting.

(*2) The output format of HDMI and RGB/Component is always the same. When a Video format is selected, component signal is output from the RGB/COMPONENT connector. When a RGB format is selected, RGB signal is output from the RGB/COMPONENT connector.

(*3) Output refresh rate is 75 Hz when frame rate is set to 50 Hz.

(*4) It can be loaded up to 4 files from USB memory.

■ Audio		
Audio Processing	Sample rate	24 bits, 48 kHz
Audio Formats	SDI (SDI IN, SDI OUT)	Linear PCM, 24 bits, 48 kHz, 2 ch * SMPTE 299M, SMPTE 272M-C
	HDMI (HDMI IN, HDMI OUT)	Linear PCM, 24 bits, 48 kHz, 2 ch
	USB-AUDIO (USB STREAMING)	Linear PCM, 16 bits, 48 kHz, 2 ch
Input Connectors	AUDIO IN 1–4	Combo type (XLR, 1/4-inch TRS phone), balanced, phantom power (DC 48 V, 10 mA Max)
	AUDIO IN 5–8	1/4-inch TRS phone type (LINE 1–2) * AUDIO IN 5 and 7 are mic level capable. (MIC 5, 7).
	AUDIO IN 9–12	RCA phono type (LINE 3–4)
Output Connectors	AUDIO OUT MAIN (L, R)	XLR type
	AUDIO OUT AUX 1 (L, R)	RCA phono type
	AUDIO OUT AUX 2/MONITOR (L, R)	1/4-inch TRS phone type
	PHONES	Stereo 1/4-inch phone type
	PHONES	Stereo miniature type
Nominal Input Level	AUDIO IN 1–4	-64 to +4 dBu (Maximum input level: +24 dBu)
	AUDIO IN 5, 7	-64 to +4 dBu (Maximum input level: +24 dBu)
	AUDIO IN 6, 8	+4 dBu (Maximum input level: +24 dBu)
	AUDIO IN 9–12	-10 dBu (Maximum input level: +10 dBu)
Input Impedance	AUDIO IN 1–4	30 kΩ
	AUDIO IN 5–8	30 kΩ
	AUDIO IN 9–12	7 kΩ
Nominal Output Level	AUDIO OUT MAIN (L, R)	+4 dBu (Maximum output level: +24 dBu)
	AUDIO OUT AUX 1 (L, R)	-10 dBu (Maximum output level: +10 dBu)
	AUDIO OUT AUX 2/MONITOR (L, R)	+4 dBu (Maximum output level: +24 dBu)
	PHONES	72 mW + 72 mW (32 Ω load)
Output Impedance	AUDIO OUT MAIN (L, R)	600 Ω
	AUDIO OUT AUX 1 (L, R)	1 kΩ
	AUDIO OUT AUX 2/MONITOR (L, R)	600 Ω
	PHONES	30 Ω
Residual Noise Level (IHF-A, typ.)	Output connectors: AUDIO OUT MAIN (L, R), AUDIO OUT AUX 2/MONITOR (L, R) -92 dBu (All faders: Min) -89 dBu ([MAIN] fader: 0.0 dB, Only channel [1] fader: 0.0 dB, Analog gain: Min) -60 dBu ([MAIN] fader: 0.0 dB, Only channel [1] fader: 0.0 dB, Analog gain: Max) * Input 150 Ω terminate	
	Output connectors: AUDIO OUT AUX 1 (L, R) -100 dBu (All faders: Min) -98 dBu ([MAIN] fader: 0.0 dB, Only channel [1] fader: 0.0 dB, Analog gain: Min) -74 dBu ([MAIN] fader: 0.0 dB, Only channel [1] fader: 0.0 dB, Analog gain: Max) * Input 150 Ω terminate	
Audio Effects	Auto mixing, Anti-feedback, 4-Band EQ, Delay, Compressor, HPF, Noise Gate, Reverb, Limiter, Voice changer, 15-Band EQ	
■ Common Section		
Remote Control	RS-232C connector	D-sub 9 pin type
	LAN port	RJ45 100BASE-TX
USB Interface	USB MEMORY port (HOST)	USB A type for USB MEMORY (USB flash drive, Still image)
	USB port (HOST)	USB A type (Use for future expansion)
	USB STREAMING port (DEVICE)	USB B type for USB-VIDEO (SuperSpeed/Hi-Speed), USB-AUDIO (Full-Speed)
Other Functions	Preset memory (8 types), Panel lock function, EDID emulator, Auto switching (Video follows audio), Remote camera control	
Display	7 inch Graphic color LCD 800 x 480 dots (touch screen)	
Power Supply	AC adaptor, Secondary AC adaptor DC 9 V to 16 V (XLR-4-32 type) * Redundant power supply	
Current Draw	2.8 A	
Power Consumption	67 W	
Operation Temperature	+0 to +40 degrees Celsius	
	+32 to +104 degrees Fahrenheit	
Dimensions	437 (W) x 325 (D) x 132 (H) mm	
	17-1/4 (W) x 12-13/16 (D) x 5-1/4 (H) inches	
Weight (excluding AC adaptor)	5.9 kg	
	13 lbs 1 oz	
Accessories	Startup Guide, Leaflet "USING THE UNIT SAFELY," AC adaptor, Power cord, Ground cord	

* 0 dBu = 0.775 Vrms

* This document explains the specifications of the product at the time that the document was issued. For the latest information, refer to the Roland website.

Dimensions

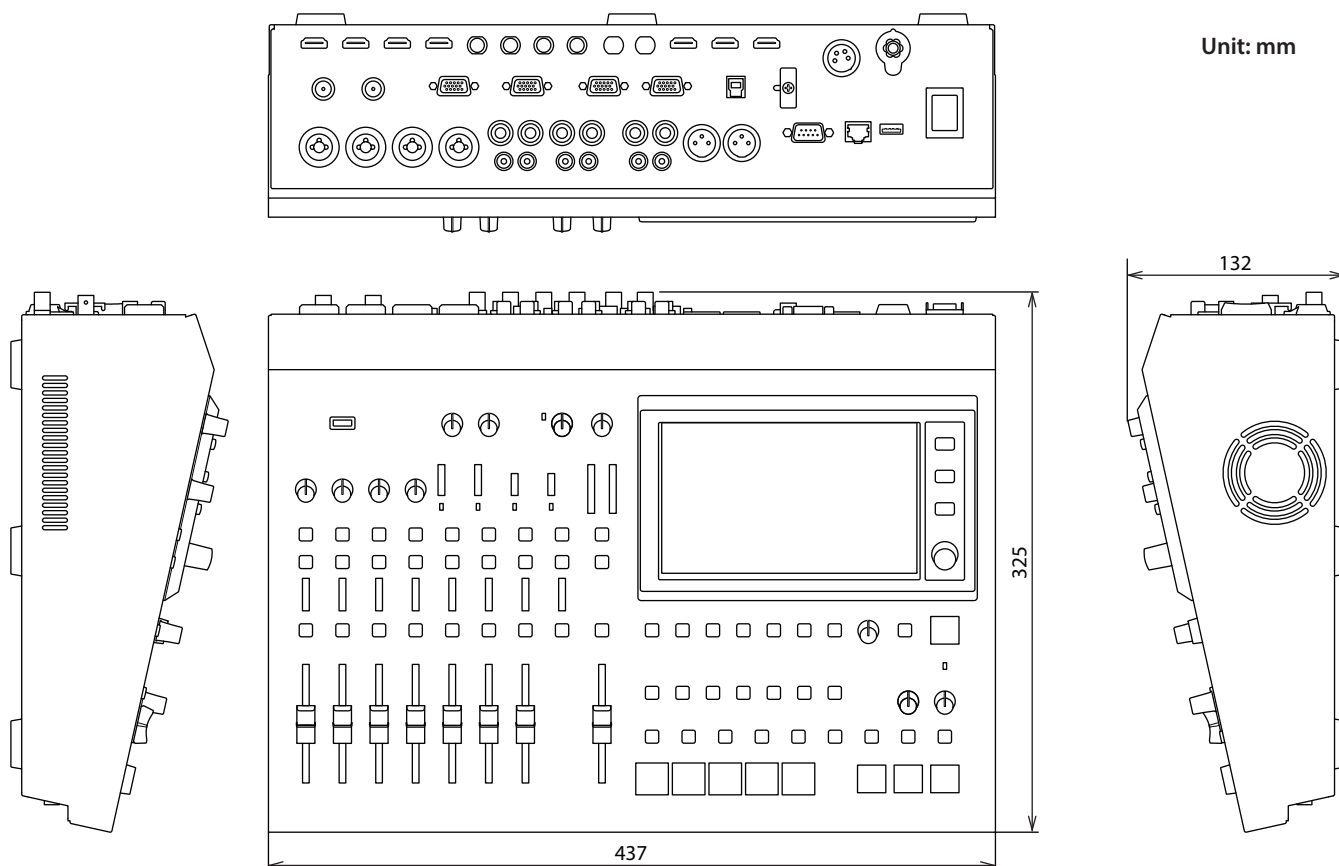

Video Block Diagram

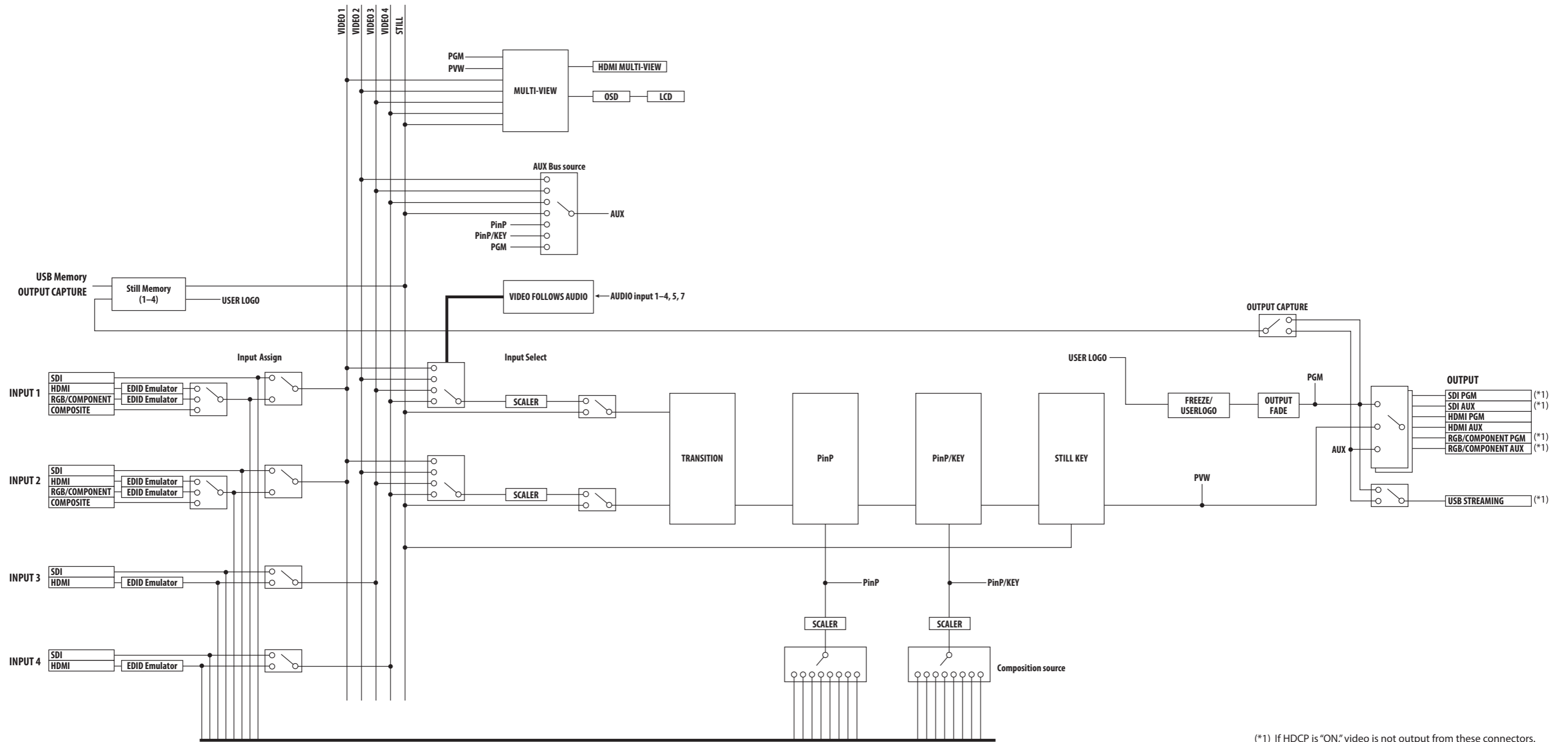

(*1) If HDCP is "ON," video is not output from these connectors.

Audio Block Diagram

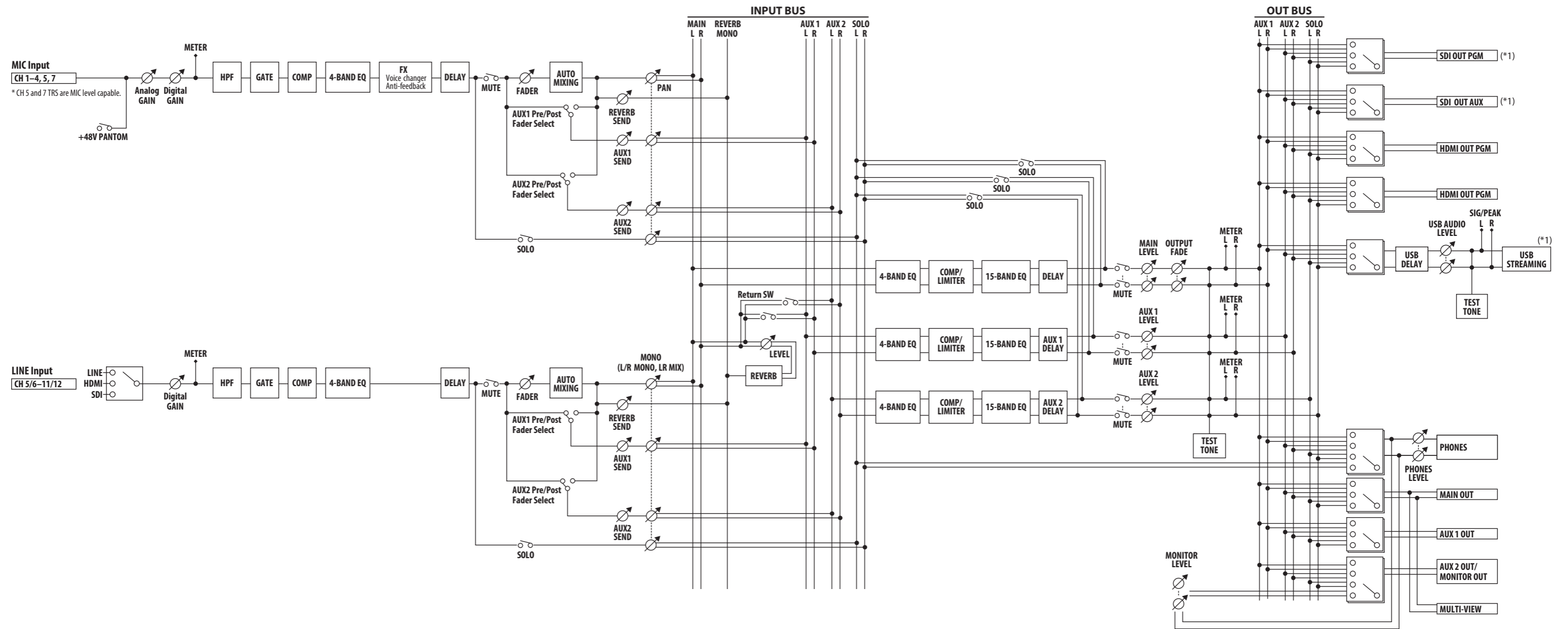

(*1) If HDCP is "ON," audio is not output from these connectors.