



# Table of Contents

<b>Usage Notice</b> .....	2	SETUP .....	42
<i>Safety Information</i> .....	2	SETUP   <i>Audio Settings</i> .....	44
<i>Precautions</i> .....	3	SETUP   <i>Network</i> .....	45
<i>Eye Safety Warnings</i> .....	5	SETUP   <i>Advanced</i> .....	46
<i>Product Features</i> .....	5	OPTIONS .....	47
<b>Introduction</b> .....	6	OPTIONS   <i>Advanced</i> .....	49
<i>Package Overview</i> .....	6	OPTIONS   <i>Lamp Settings</i> .....	51
<i>Product Overview</i> .....	7	OPTIONS   <i>Optional Filter Settings</i> ..	52
<i>Front View</i> .....	7	<b>Appendices</b> .....	53
<i>Rear View</i> .....	8	<i>Network Control</i> .....	53
<i>Control Panel</i> .....	9	<i>Network Menu</i> .....	53
<i>Input/Output Connections</i> .....	10	<i>Troubleshooting</i> .....	61
<i>Remote Control</i> .....	11	<i>Replacing the Lamp</i> .....	67
<b>Installation</b> .....	12	<i>Installing and Cleaning the Optional     Dust Filter</i> .....	69
<i>Connecting the Projector</i> .....	12	<i>Compatibility Modes</i> .....	71
<i>Connect to Computer/Notebook</i> .....	12	<i>Computer/Video/HDMI/Mac         Compatibility</i> .....	71
<i>Connect to Video Sources</i> .....	13	<i>RS232 Commands and Protocol     Function List</i> .....	73
<i>Powering the Projector On / Off</i> .....	14	<i>RS232 Pin Assignments</i> .....	73
<i>Powering On the Projector</i> .....	14	<i>RS232 Protocol Function List</i> .....	74
<i>Powering off the projector</i> .....	15	<i>Ceiling Mount Installation</i> .....	79
<i>Warning Indicator</i> .....	15	<i>Regulation &amp; Safety Notices</i> .....	81
<i>Adjusting the Projected Image</i> .....	16	<i>FCC Notice</i> .....	81
<i>Adjusting the Projector's Height</i> .....	16	<i>Notice: Shielded cables</i> .....	81
<i>Adjusting the Projector's Focus /         Zoom</i> .....	17	<i>Caution</i> .....	81
<i>Adjusting Projection Image Size</i> .....	18	<i>Operation Conditions</i> .....	82
<i>Adjusting Projection Image Size</i> .....	18	<i>Notice: Canadian users</i> .....	82
<i>Adjusting Projection Image Size</i> .....	18	<i>Remarque à l'intention des         utilisateurs canadiens</i> .....	82
<i>Adjusting Projection Image Size</i> .....	18	<i>Declaration of Conformity for EU         countries</i> .....	82
<b>User Controls</b> .....	24		
<i>Control Panel &amp; Remote Control</i> .....	24		
<i>Control Panel</i> .....	24		
<i>Remote Control Battery Installation</i> ..	25		
<i>Remote Control</i> .....	26		
<i>On-screen Display Menus</i> .....	30		
<i>How to operate</i> .....	30		
<i>Menu Tree</i> .....	31		
<i>IMAGE</i> .....	34		
<i>IMAGE   Advanced</i> .....	36		
<i>IMAGE   Advanced   Signal</i> .....	38		
<i>DISPLAY</i> .....	39		
<i>DISPLAY   3D</i> .....	41		

## Safety Information

	The lightning flash with arrow head within an equilateral triangle is intended to alert the user to the presence of uninsulated "dangerous voltage" within the product's enclosure that may be of sufficient magnitude to constitute a risk of electric shock to persons.
	The exclamation point within an equilateral triangle is intended to alert the user to the presence of important operating and maintenance (servicing) instructions in the literature accompanying the appliance.

**WARNING:** TO REDUCE THE RISK OF FIRE OR ELECTRIC SHOCK, DO NOT EXPOSE THIS APPLIANCE TO RAIN OR MOISTURE. DANGEROUS HIGH VOLTAGES ARE PRESENT INSIDE THE ENCLOSURE. DO NOT OPEN THE CABINET. REFER SERVICING TO QUALIFIED PERSONNEL ONLY.

### Important Safety Instruction

1. Do not block any ventilation openings. To ensure reliable operation of the projector and to protect from overheating, it is recommended to install the projector in a location that does not block ventilation. As an example, do not place the projector on a crowded coffee table, sofa, bed, etc. Do not put the projector in an enclosure such as a book case or a cabinet that restricts air flow.
2. Do not use the projector near water or moisture. To reduce the risk of fire and/or electric shock, do not expose the projector to rain or moisture.
3. Do not install near heat sources such as radiators, heaters, stoves or any other apparatus such as amplifiers that emit heat.
4. Clean only with dry cloth.
5. Only use attachments/accessories specified by the manufacturer.
6. Do not let objects or liquids enter the projector. They may touch dangerous voltage points and short out parts that could result in fire or electric shock.
7. See projector enclosure for safety related markings.
8. The unit should only be repaired by appropriate service personnel.

## Precautions



*Please follow all warnings, precautions and maintenance as recommended in this user's guide.*

- Warning- Do not look into the projector's lens when the lamp is on. The bright light may hurt and damage your eyes.
- Warning- To reduce the risk of fire or electric shock, do not expose this projector to rain or moisture.
- Warning- Please do not open or disassemble the projector as this may cause electric shock.
- Warning- When replacing the lamp, please allow the unit to cool down. Follow instructions as described on pages 67-68.
- Warning- This projector detects lamp life. Please be sure to change the lamp when a warning message is displayed.
- Warning- When switching the projector off, please ensure the cooling cycle has been completed before disconnecting power. Allow 90 seconds for the projector to cool down.
- Warning- Not all projectors come with a lens cap. For your safety, if the projector is equipped with a lens cap please ensure to remove it before you turn on the projector.



- ❖ When the lamp reaches the end of its life, the projector will not turn back on until the lamp module has been replaced. To replace the lamp, follow the procedures listed under "Replacing the Lamp" section on pages 67-68.

# Usage Notice

## Do:

- ❖ Turn off and unplug the power plug from the AC outlet before cleaning the product.
- ❖ Use a soft dry cloth with mild detergent to clean the display housing.
- ❖ Disconnect the power plug from AC outlet if the product is not being used for a long period of time.
- ❖ Use room blinds to reduce ambient light in order to minimize lamp power.

## Do not:

- ❖ Block the projector inlet or outlet air vents.

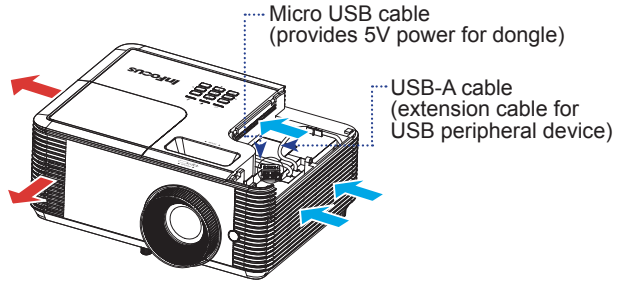

### Short-throw lens models

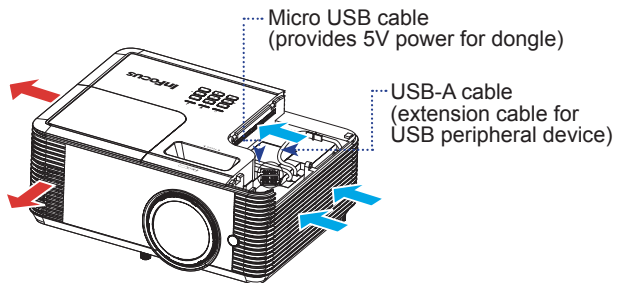

- ❖ Use abrasive cleaners, waxes or solvents to clean the unit.
- ❖ Use under the following conditions:
  - In extremely hot, cold or humid environments.
    - ▶ Ensure that the ambient room temperature is within 5 - 40°C.
    - ▶ Relative Humidity is 5 - 40°C, 80% (Max.), non-condensing.
  - In areas susceptible to excessive dust and dirt.
  - Near any appliance generating a strong magnetic field.
  - In direct sunlight.

## Eye Safety Warnings



- Avoid staring/facing directly into the projector beam at all times. Keep your back to the beam as much as possible.
- When projector is used in a classroom, ensure students do not look into the beam when they are asked to point something out on screen.

## Product Features

- XGA (1024x768) / WXGA (1280x800) / 1080p (1920 x1080) Native resolution
- HD compatible – 720p and 1080p supported
- BrilliantColor™ Technology
- Kensington Lock
- RS232 control
- RJ-45 control\*
- Rapid shutdown
- The Product Features shall be configured by the manufacturer as per practical conditions.



- ❖ (\*) For models with RJ-45.
- ❖ Product features may vary depending on model.

# Introduction

## Package Overview

*Unpack and inspect the contents to ensure all parts listed below are in the box. If something is missing, please contact your nearest customer service center.*

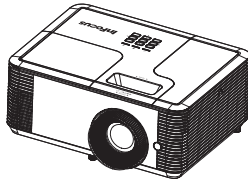

Projector

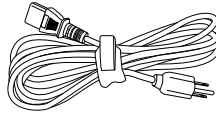

Power Cord

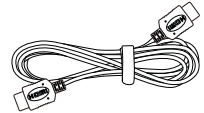

HDMI Cable



❖ Due to different applications in each country, some regions may have different accessories.



IR Remote Control

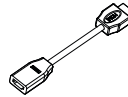

HDMI Extension Cable

### Documentation:

- User's Manual
- Quick Start Card
- Safety/Warranty Booklet

# Introduction

## Product Overview

Front View

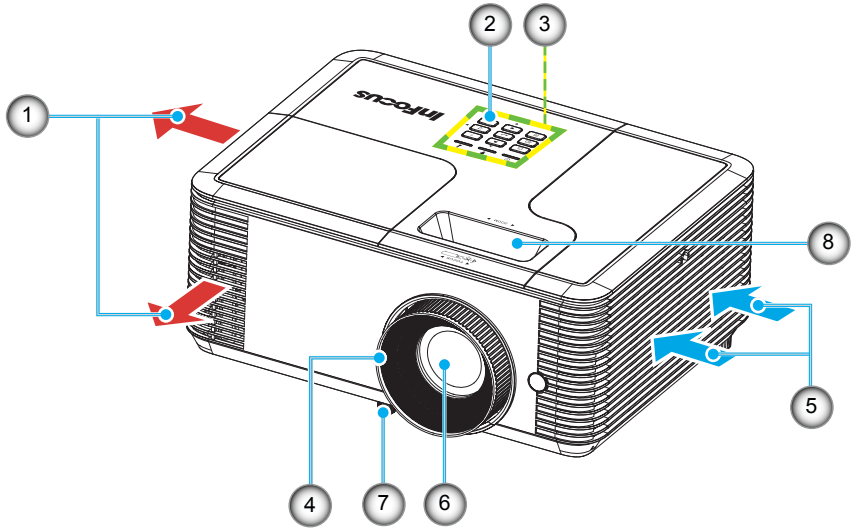

Short-throw lens models

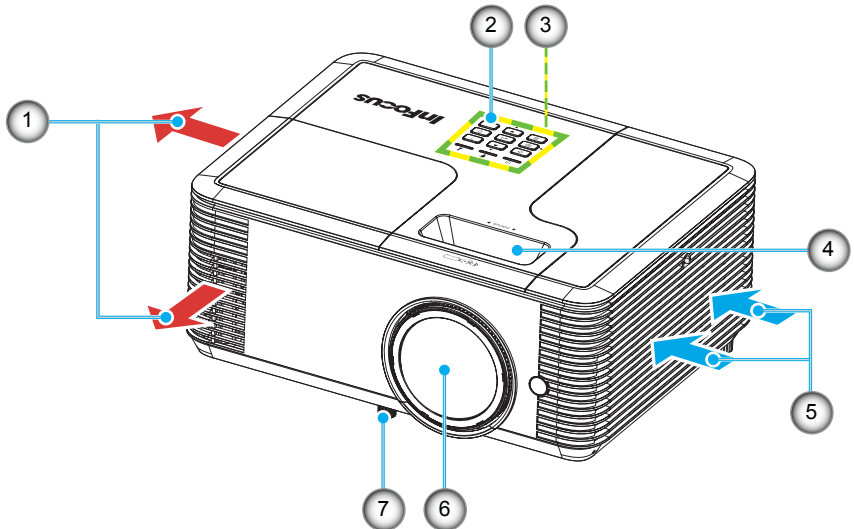

# Introduction

## Rear View

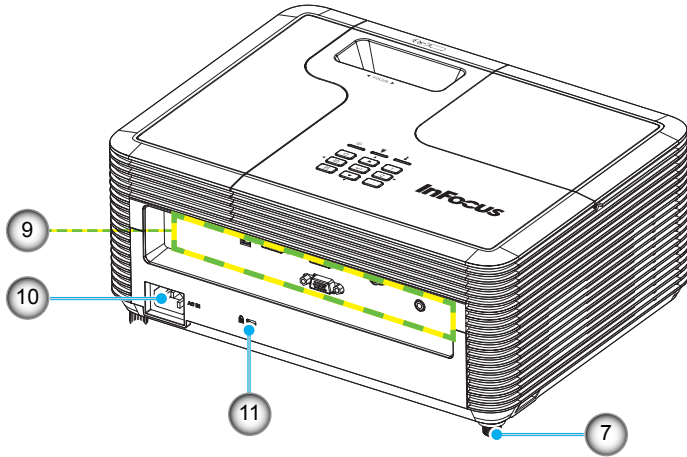

### NOTE

- ❖ The interface is subject to model's specifications.
- ❖ Do not block projector in/out air vents.

1. Ventilation (outlet)
2. IR Receiver (remove protective film)
3. Control Panel
4. Focus Ring/Lever
5. Ventilation (inlet)
6. Lens
7. Tilt-Adjustment Feet
8. Zoom Lever
9. Input / Output Connections
10. Power Socket
11. Kensington™ Lock Port



# Introduction

## Control Panel

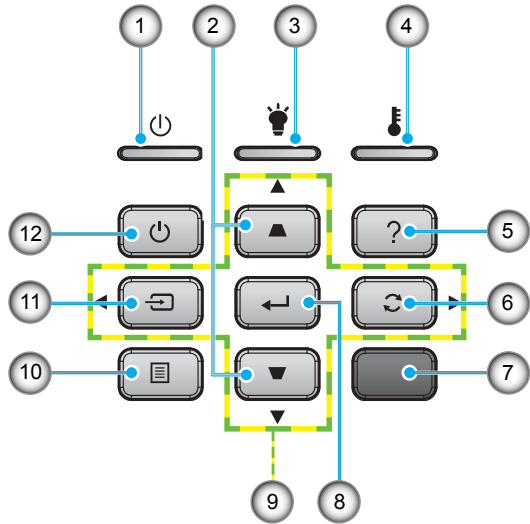

1. On/Standby LED
2. Keystone Correction
3. Lamp LED
4. Temp LED
5. Help
6. Re-Sync
7. IR Receiver (remove protective film)
8. Enter
9. Four Directional Select Keys
10. Menu
11. Source
12. Power

# Introduction

## Input/Output Connections

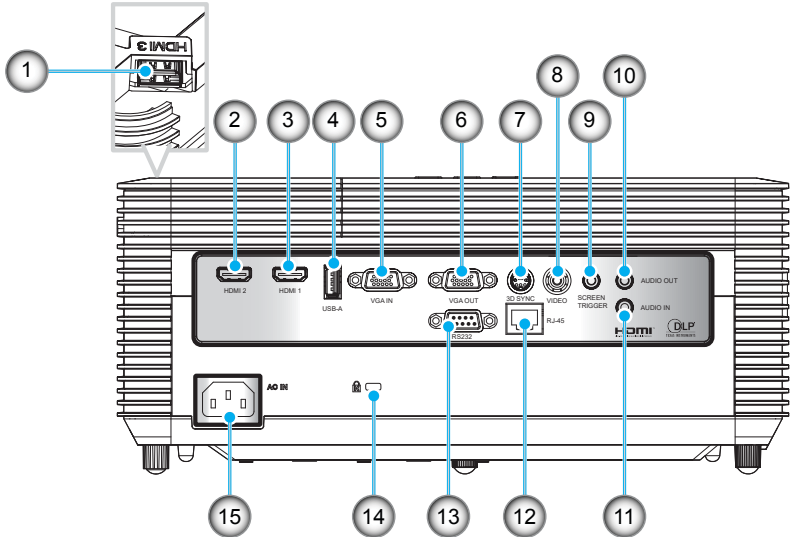

1. HDMI3 Connector
2. HDMI2 Connector
3. HDMI1 Connector
4. USB Type A Connector
5. VGA IN Connector
6. VGA OUT Connector
7. 3D Sync Connector
8. Composite Video Connector
9. Screen Trigger Connector
10. Audio Output Connector (3.5mm mini jack)
11. Audio Input Connector (3.5mm mini jack)
12. RJ-45 Connector
13. RS232 Connector (9-pin)
14. Kensington Lock
15. Power Socket



❖ The interface is subject to model's specifications.

## Remote Control

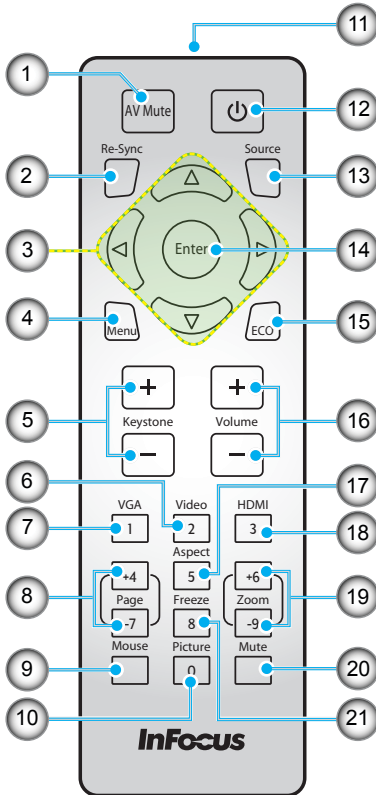

1. AV Mute
2. Re-Sync
3. Four Directional Select Keys
4. Menu
5. Keystone +/-
6. Video
7. VGA
8. Page +/-
9. Mouse
10. Picture
11. IR LED
12. Power
13. Source
14. Enter
15. ECO
16. Volume +/-
17. Aspect
18. HDMI
19. Zoom +/-
20. Mute
21. Freeze

# Installation

## Connecting the Projector

### Connect to Computer/Notebook

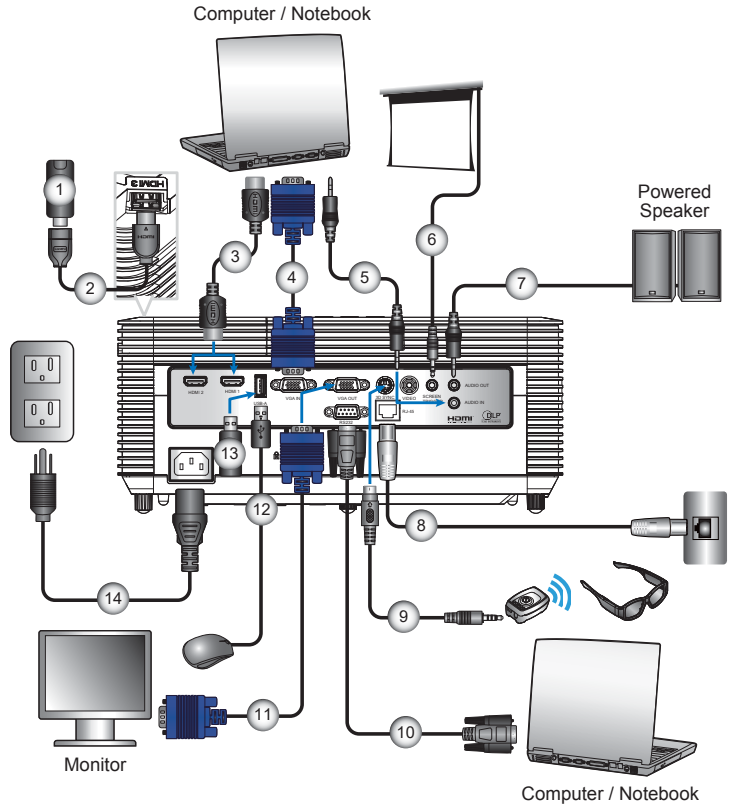

- ❖ Due to the difference in applications for each country, some regions may have different accessories.
- ❖ (\*) Optional accessory
- ❖ (\*\*) End user needs to purchase by themselves.
- ❖ (\*\*\*) USB has three functions: Service, Remote Mouse Control, and USB connection for HDMI device.
- ❖ The interface is subject to model's specifications.

1.....	HDMI Device**
2.....	HDMI Extension Cable
3.....	HDMI Cable
4.....	VGA-In Cable*
5.....	Audio Input Cable*
6.....	12V 200ma DC Jack*
7.....	Audio Output Cable*
8.....	RJ-45 Cable*
9.....	3D Emitter Cable*
10.....	RS232 Cable*
11.....	VGA-out Cable*
12.....	USB Cable***
13.....	USB Drive**
14.....	Power Cord

# Installation

## Connect to Video Sources

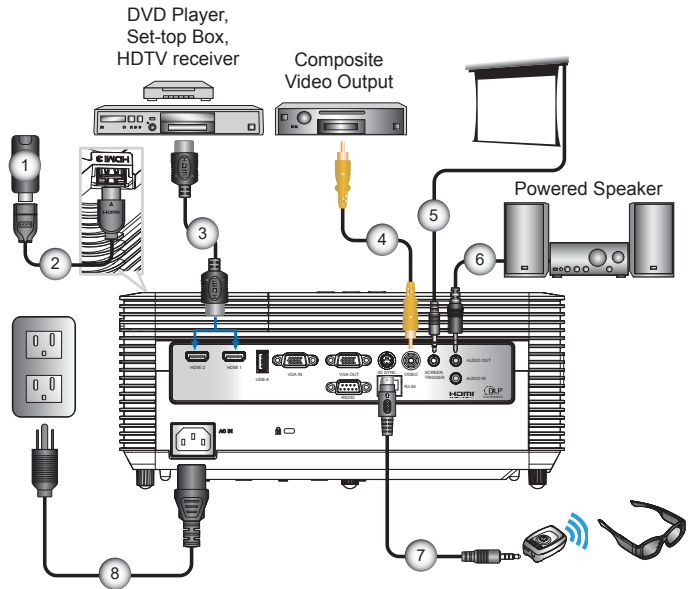

- ❖ Due to the difference in applications for each country, some regions may have different accessories.
- ❖ (\*) Optional accessory
- ❖ (\*\*) End user needs to purchase by themself.
- ❖ The interface is subject to model's specifications.

1.....	HDMI Device**
2.....	HDMI Extension Cable
3.....	HDMI Cable
4.....	Composite Video Cable*
5.....	12V 200ma DC Jack*
6.....	Audio Output Cable*
7.....	3D Emitter Cable*
8.....	Power Cord

## Powering the Projector On / Off

### Powering On the Projector

1. Securely connect the power cord and signal cable. When connected, the On/Standby LED will turn red.
2. Turn on the lamp by pressing the “” button either on the remote control or the control panel. The On/Standby LED will now flash blue. ①

The startup screen will display in approximately 10 seconds. The first time you use the projector, you will be asked to select the preferred language and power saving mode.

3. Turn on and connect the source that you want to display on the screen (computer, notebook, video player, etc). The projector will detect the source automatically. If not, press the “Menu” button and go to “OPTIONS”. Make sure that the “Source Lock” has been set to “Off”.

- ❖ If you connect multiple sources at the same time, press the “Source” button on the control panel or direct source keys on the remote control to switch between inputs.

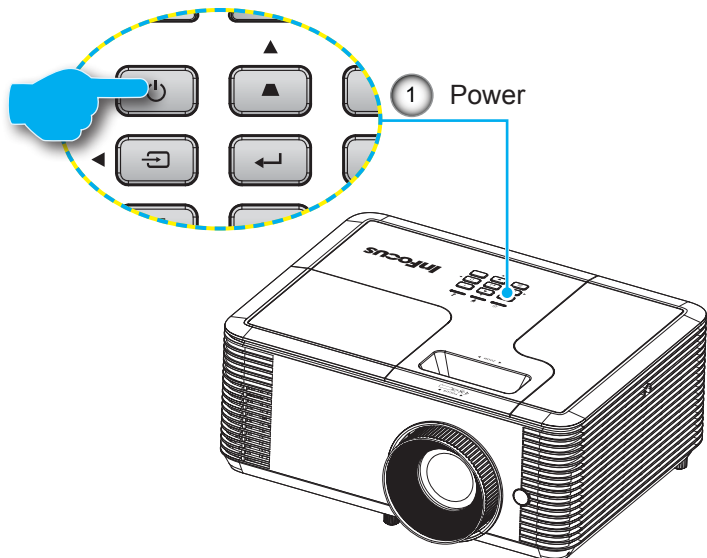

## Powering off the projector

1. Press the “⏻” button on the remote control or the control panel to turn off the projector.  
The following message will be displayed on the screen.

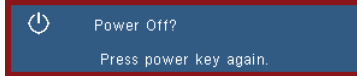

Press the “⏻” button again to confirm otherwise the message will disappear after 10 seconds. The projector will shut down when the “⏻” button is pressed for the second time.

2. The fans will continue to operate for 10 seconds and the On/Standby LED will flash blue. During this period, the projector cannot be turned back on and the projector should not be unplugged.

Once the cooling cycle is complete the On/Standby LED will turn to solid red (standby mode). At this point, the projector can be turned back on by pressing the “⏻” button.

3. Disconnect the power cord from the electrical outlet and the projector.

## Warning Indicator

When the warning indicators (see below) come on, the projector will automatically shutdown:



- ❖ Contact the nearest service center if the projector displays these symptoms. See page 65 for more information.
- ❖ Lamp LED indicator is lit red and if the On/Standby LED flashes red. This indicates the projector lamp has failed.
- ❖ Temp LED indicator is lit red and if the On/Standby LED flashes red. This indicates the projector has overheated. Under normal conditions, the projector can be switched back on.
- ❖ Temp LED indicator flashes red and if the On/Standby LED flashes red. This indicates a fan failure.

Unplug the power cord from the projector, wait for 30 seconds and try again. If the warning indicators light up again, please contact your nearest service center for assistance.

## Adjusting the Projected Image

### Adjusting the Projector's Height

*The projector is equipped with tilt-adjustment feet for adjusting the image height.*

1. Locate the tilt-adjustment foot you wish to modify on the underside of the projector.
2. Rotate the adjustable ring clockwise to raise the projector or counter clockwise to lower it. Repeat with the remaining feet as needed.

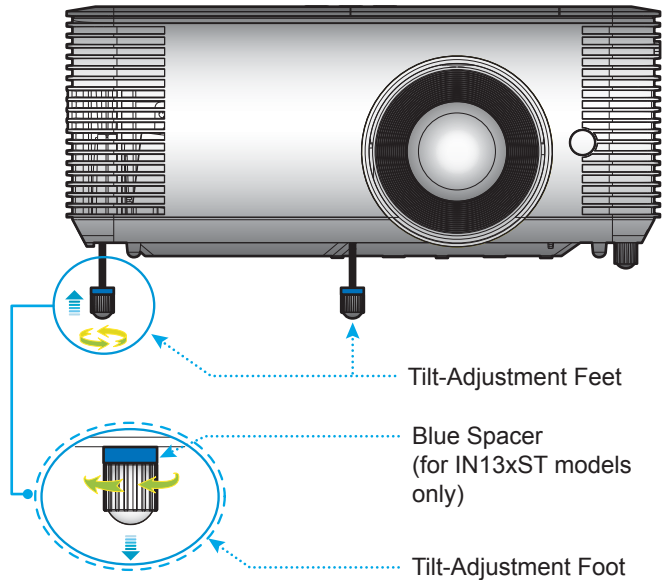

❖ The blue spacers are only applicable for IN13xST models. Do not remove them from the tilt-adjustment feet.



# Installation

## Adjusting the Projector's Focus / Zoom

To focus the image, rotate the focus ring or turn the focus lever (for short-throw lens models) until the image is clear. You may turn the zoom lever to zoom in or out.

For more information about the focus distance, please refer to the table below:

Model Type/Name	Focus Distance
XGA (IN134 model)	1.2 to 12.02 meters
WXGA (IN136 model)	1 to 10 meters
1080p (IN138HD/SP2080HD model)	1 to 7.5 meters
XGA (IN134ST model)	0.4 to 3.81 meters
WXGA (IN136ST model)	0.4 to 3.4 meters
1080p (IN138HDST model)	0.4 to 3.4 meters
XGA (IN2134 model)	1.2 to 9.02 meters
WXGA (IN2136 model)	1 to 7.7 meters
1080p (IN2138HD model)	1 to 7.5 meters

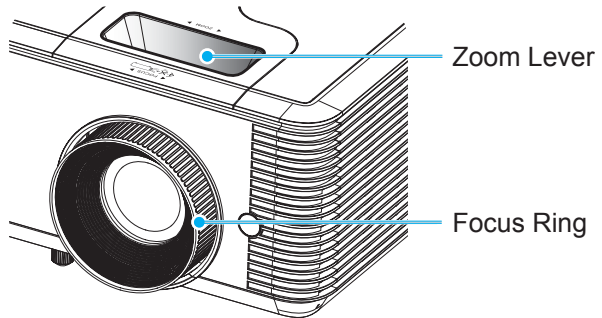

### Short-throw lens models

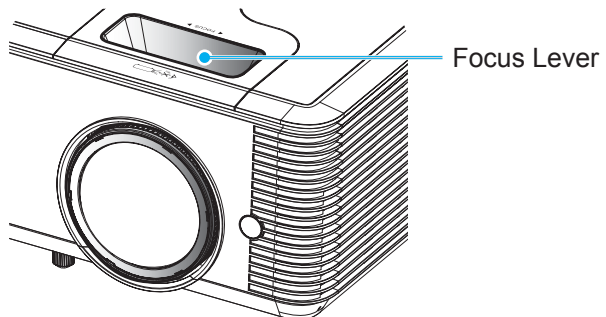

# Installation

## Adjusting Projection Image Size

For more information about the projection image size, please refer to the table below:

Model Type/Name	Projection Image Size
XGA (IN134 model)	27.3 to 304.4 inches
WXGA (IN136 model)	27 to 300.7 inches
1080p (IN138HD/SP2080HD model)	30.8 to 301.4 inches
XGA (IN134ST model)	31.9 to 303.1 inches
WXGA (IN136ST model)	35.6 to 303 inches
1080p (IN138HDST model)	36.2 to 307.8 inches
XGA (IN2134 model)	30.7 to 300.3 inches
WXGA (IN2136 model)	30.1 to 303 inches
1080p (IN2138HD model)	30.8 to 301.4 inches

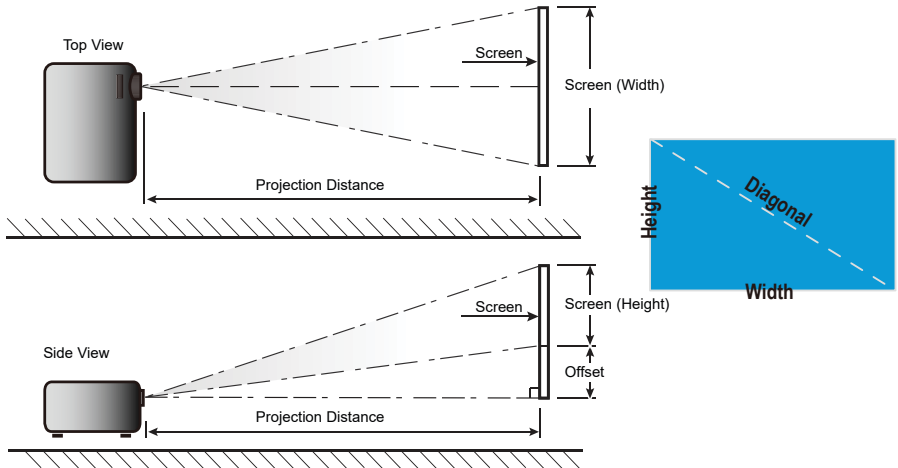

# Installation

## IN13x models

4:3 diagonal screen	Height	Width	Height	Width	Projection Distance				Offset	
					Min.	Max.	Min.	Max.		
	(inches)	(inches)	(meters)	(meters)	(feet)	(feet)	(meters)	(meters)	(cm)	(inches)
27.3	16.41	21.87	0.42	0.56	-	3.94	-	1.20	6.25	2.46
40.0	24.04	32.05	0.61	0.81	5.18	5.77	1.58	1.76	9.16	3.61
60.0	36.06	48.08	0.92	1.22	7.77	8.65	2.37	2.64	13.74	5.41
70.0	42.07	56.09	1.07	1.42	9.07	10.10	2.76	3.08	16.03	6.31
80.0	48.08	64.10	1.22	1.63	10.36	11.54	3.16	3.52	18.32	7.21
90.0	54.09	72.12	1.37	1.83	11.66	12.98	3.55	3.96	20.61	8.11
100.0	60.10	80.13	1.53	2.04	12.95	14.42	3.95	4.40	22.90	9.01
120.0	72.12	96.15	1.83	2.44	15.54	17.31	4.74	5.28	27.48	10.82
150.0	90.14	120.19	2.29	3.05	19.43	21.63	5.92	6.59	34.34	13.52
180.0	108.17	144.23	2.75	3.66	23.32	25.96	7.11	7.91	41.21	16.23
250.0	150.24	200.32	3.82	5.09	32.39	36.06	9.87	10.99	57.24	22.54
304.4	182.93	243.91	4.65	6.20	39.43	-	12.02	-	69.70	27.44

16:10 diagonal screen	Height	Width	Height	Width	Projection Distance				Offset	
					Min.	Max.	Min.	Max.		
	(inches)	(inches)	(meters)	(meters)	(feet)	(feet)	(meters)	(meters)	(cm)	(inches)
27.0	14.31	22.90	0.36	0.58	-	3.28	-	1.00	4.51	1.77
40.0	21.20	33.92	0.54	0.86	4.36	4.86	1.33	1.48	6.68	2.63
60.0	31.80	50.88	0.81	1.29	6.55	7.29	2.00	2.22	10.02	3.94
70.0	37.10	59.36	0.94	1.51	7.64	8.51	2.33	2.59	11.69	4.60
80.0	42.40	67.84	1.08	1.72	8.73	9.72	2.66	2.96	13.35	5.26
90.0	47.70	76.32	1.21	1.94	9.82	10.94	2.99	3.33	15.02	5.91
100.0	53.00	84.80	1.35	2.15	10.91	12.15	3.33	3.70	16.69	6.57
120.0	63.60	101.76	1.62	2.58	13.09	14.59	3.99	4.45	20.03	7.89
150.0	79.50	127.20	2.02	3.23	16.37	18.23	4.99	5.56	25.04	9.86
180.0	95.40	152.64	2.42	3.88	19.64	21.88	5.99	6.67	30.05	11.83
250.0	132.50	212.00	3.37	5.38	27.28	30.39	8.31	9.26	41.73	16.43
300.7	159.37	254.99	4.05	6.48	32.81	-	10.00	-	50.20	19.76

# Installation

16:9 diagonal screen	Height	Width	Height	Width	Projection Distance				Offset	
					Min.	Max.	Min.	Max.		
	(inches)	(inches)	(meters)	(meters)	(feet)	(feet)	(meters)	(meters)	(cm)	(inches)
30.8	15.10	26.84	0.38	0.68	-	39.38	-	1.00	6.14	2.42
40.0	19.61	34.86	0.50	0.89	39.19	51.14	1.00	1.30	7.97	3.14
60.0	29.42	52.29	0.75	1.33	58.78	76.72	1.49	1.95	11.95	4.71
70.0	34.32	61.01	0.87	1.55	68.58	89.50	1.74	2.27	13.95	5.49
80.0	39.22	69.73	1.00	1.77	78.37	102.29	1.99	2.60	15.94	6.28
90.0	44.12	78.44	1.12	1.99	88.17	115.07	2.24	2.92	17.93	7.06
100.0	49.03	87.16	1.25	2.21	97.97	127.86	2.49	3.25	19.92	7.84
120.0	58.83	104.59	1.49	2.66	117.56	153.43	2.99	3.90	23.91	9.41
150.0	73.54	130.74	1.87	3.32	146.95	191.79	3.73	4.87	29.89	11.77
180.0	88.25	156.88	2.24	3.98	176.34	230.15	4.48	5.85	35.86	14.12
250.0	122.57	217.89	3.11	5.53	244.91	319.65	6.22	8.12	49.81	19.61
301.4	147.76	262.69	3.75	6.67	295.27	-	7.50	-	60.05	23.64

## IN13xST models

4:3 diagonal screen	Height	Width	Height	Width	Projection Distance		Offset	
					(feet)	(meters)	(cm)	(inches)
31.9	19.17	25.56	0.49	0.65	1.31	0.40	7.30	2.88
40.0	24.04	32.05	0.61	0.81	1.65	0.50	9.16	3.61
60.0	36.06	48.08	0.92	1.22	2.47	0.75	13.74	5.41
70.0	42.07	56.09	1.07	1.42	2.88	0.88	16.03	6.31
80.0	48.08	64.10	1.22	1.63	3.30	1.00	18.32	7.21
90.0	54.09	72.12	1.37	1.83	3.71	1.13	20.61	8.11
100.0	60.10	80.13	1.53	2.04	4.12	1.26	22.90	9.01
120.0	72.12	96.15	1.83	2.44	4.94	1.51	27.48	10.82
150.0	90.14	120.19	2.29	3.05	6.18	1.88	34.34	13.52
180.0	108.17	144.23	2.75	3.66	7.42	2.26	41.21	16.23
250.0	150.24	200.32	3.82	5.09	10.30	3.14	57.24	22.54
303.1	182.15	242.87	4.63	6.17	12.49	3.81	69.40	27.32

# Installation

16:10 diagonal screen	Height	Width	Height	Width	Projection Distance		Offset	
	(inches)	(inches)	(meters)	(meters)	(feet)	(meters)	(cm)	(inches)
35.6	18.87	30.19	0.48	0.77	1.31	0.40	5.94	2.34
40.0	21.20	33.92	0.54	0.86	1.47	0.45	6.68	2.63
60.0	31.80	50.88	0.81	1.29	2.21	0.67	10.02	3.94
70.0	37.10	59.36	0.94	1.51	2.58	0.79	11.69	4.60
80.0	42.40	67.84	1.08	1.72	2.95	0.90	13.35	5.26
90.0	47.70	76.32	1.21	1.94	3.31	1.01	15.02	5.91
100.0	53.00	84.80	1.35	2.15	3.68	1.12	16.69	6.57
120.0	63.60	101.76	1.62	2.58	4.42	1.35	20.03	7.89
150.0	79.50	127.20	2.02	3.23	5.52	1.68	25.04	9.86
180.0	95.40	152.64	2.42	3.88	6.63	2.02	30.05	11.83
250.0	132.50	212.00	3.37	5.38	9.20	2.81	41.73	16.43
303.0	160.59	256.94	4.08	6.53	11.16	3.40	50.58	19.91

16:9 diagonal screen	Height	Width	Height	Width	Projection Distance		Offset	
	(inches)	(inches)	(meters)	(meters)	(feet)	(meters)	(cm)	(inches)
36.2	17.75	31.55	0.45	0.80	15.74	0.40	7.21	2.84
40.0	19.61	34.86	0.50	0.89	17.40	0.44	7.97	3.14
60.0	29.42	52.29	0.75	1.33	26.09	0.66	11.95	4.71
70.0	34.32	61.01	0.87	1.55	30.44	0.77	13.95	5.49
80.0	39.22	69.73	1.00	1.77	34.79	0.88	15.94	6.28
90.0	44.12	78.44	1.12	1.99	39.14	0.99	17.93	7.06
100.0	49.03	87.16	1.25	2.21	43.49	1.10	19.92	7.84
120.0	58.83	104.59	1.49	2.66	52.19	1.33	23.91	9.41
150.0	73.54	130.74	1.87	3.32	65.24	1.66	29.89	11.77
180.0	88.25	156.88	2.24	3.98	78.28	1.99	35.86	14.12
250.0	122.57	217.89	3.11	5.53	108.73	2.76	49.81	19.61
307.8	150.90	268.27	3.83	6.81	133.87	3.40	61.33	24.14

# Installation

## IN213x models

4:3 diagonal screen	Height	Width	Height	Width	Projection Distance				Offset	
					Min.	Max.	Min.	Max.		
	(inches)	(inches)	(meters)	(meters)	(feet)	(feet)	(meters)	(meters)	(cm)	(inches)
30.7	18.45	24.60	0.47	0.62	-	3.95	-	1.20	7.03	2.77
40.0	24.04	32.05	0.61	0.81	3.94	5.14	1.20	1.57	9.16	3.61
60.0	36.06	48.08	0.92	1.22	5.91	7.71	1.80	2.35	13.74	5.41
70.0	42.07	56.09	1.07	1.42	6.89	9.00	2.10	2.74	16.03	6.31
80.0	48.08	64.10	1.22	1.63	7.88	10.28	2.40	3.13	18.32	7.21
90.0	54.09	72.12	1.37	1.83	8.86	11.57	2.70	3.53	20.61	8.11
100.0	60.10	80.13	1.53	2.04	9.85	12.85	3.00	3.92	22.90	9.01
120.0	72.12	96.15	1.83	2.44	11.82	15.42	3.60	4.70	27.48	10.82
150.0	90.14	120.19	2.29	3.05	14.77	19.28	4.50	5.88	34.34	13.52
180.0	108.17	144.23	2.75	3.66	17.73	23.14	5.40	7.05	41.21	16.23
250.0	150.24	200.32	3.82	5.09	24.62	32.13	7.51	9.79	57.24	22.54
300.3	180.47	240.62	4.58	6.11	29.58	-	9.02	-	68.76	27.07

16:10 diagonal screen	Height	Width	Height	Width	Projection Distance				Offset	
					Min.	Max.	Min.	Max.		
	(inches)	(inches)	(meters)	(meters)	(feet)	(feet)	(meters)	(meters)	(cm)	(inches)
30.1	15.95	25.52	0.41	0.65	-	3.28	-	1.00	5.02	1.98
40.0	21.20	33.92	0.54	0.86	3.34	4.35	1.02	1.33	6.68	2.63
60.0	31.80	50.88	0.81	1.29	5.00	6.53	1.52	1.99	10.02	3.94
70.0	37.10	59.36	0.94	1.51	5.84	7.62	1.78	2.32	11.69	4.60
80.0	42.40	67.84	1.08	1.72	6.67	8.71	2.03	2.65	13.35	5.26
90.0	47.70	76.32	1.21	1.94	7.50	9.79	2.29	2.99	15.02	5.91
100.0	53.00	84.80	1.35	2.15	8.34	10.88	2.54	3.32	16.69	6.57
120.0	63.60	101.76	1.62	2.58	10.01	13.06	3.05	3.98	20.03	7.89
150.0	79.50	127.20	2.02	3.23	12.51	16.32	3.81	4.98	25.04	9.86
180.0	95.40	152.64	2.42	3.88	15.01	19.59	4.57	5.97	30.05	11.83
250.0	132.50	212.00	3.37	5.38	20.85	27.21	6.35	8.29	41.73	16.43
303.0	160.59	256.94	4.08	6.53	25.27	-	7.70	-	50.58	19.91

# Installation







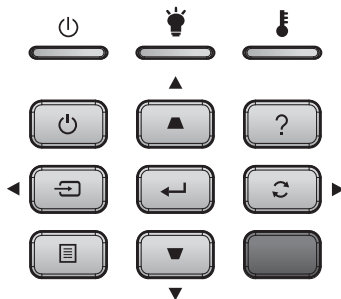









16:9 diagonal screen	Height	Width	Height	Width	Projection Distance				Offset	
					Min.	Max.	Min.	Max.		
	(inches)	(inches)	(meters)	(meters)	(feet)	(feet)	(meters)	(meters)	(cm)	(inches)
30.8	15.10	26.84	0.38	0.68	-	39.38	-	1.00	6.14	2.42
50.0	24.51	43.58	0.62	1.11	48.98	63.93	1.24	1.62	9.96	3.92
60.0	29.42	52.29	0.75	1.33	58.78	76.72	1.49	1.95	11.95	4.71
70.0	34.32	61.01	0.87	1.55	68.58	89.50	1.74	2.27	13.95	5.49
80.0	39.22	69.73	1.00	1.77	78.37	102.29	1.99	2.60	15.94	6.28
90.0	44.12	78.44	1.12	1.99	88.17	115.07	2.24	2.92	17.93	7.06
100.0	49.03	87.16	1.25	2.21	97.97	127.86	2.49	3.25	19.92	7.84
120.0	58.83	104.59	1.49	2.66	117.56	153.43	2.99	3.90	23.91	9.41
150.0	73.54	130.74	1.87	3.32	146.95	191.79	3.73	4.87	29.89	11.77
180.0	88.25	156.88	2.24	3.98	176.34	230.15	4.48	5.85	35.86	14.12
250.0	122.57	217.89	3.11	5.53	244.91	319.65	6.22	8.12	49.81	19.61
301.4	147.76	262.69	3.75	6.67	295.27	-	7.50	-	60.05	23.64

## Control Panel & Remote Control

### Control Panel



#### Using the Control Panel

Power		Refer to the "Powering the Projector On / Off" section on pages 14-15.
Source		Select the input source.
Menu		Launch the on-screen display (OSD) menu. Press again to exit OSD menu.
Help		Help Menu (only available when OSD menu is not shown).
Re-Sync		Automatically synchronize the projector to the input source.
Enter		Confirm your item selection.
Four Directional Select Keys		Use     to select items or make adjustments to your selection.
Keystone	 / 	Use   to adjust image distortion caused by tilting the projector. <ul style="list-style-type: none"> <li>▶ ±20 degrees: IN134ST/IN136ST/IN138HDST model.</li> <li>▶ ±40 degrees: IN134/IN136/IN138HD/SP2080HD/IN2134/IN2136/IN2138HD model.</li> </ul>
Lamp LED		Indicates the projector's lamp status.
Temp LED		Indicates the projector's temperature status.
On/Standby LED		Indicates the projector's status.



## Remote Control Battery Installation

1. Push the clip to release the battery cover.

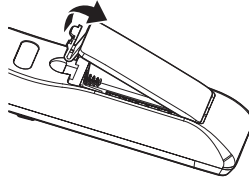

2. Install new batteries (AAA/R03). Ensure that you have the batteries' polarity (+/-) aligned correctly.

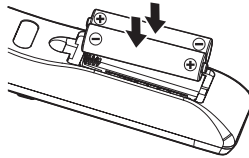

3. Close the battery cover and press it down until it clicks into place. Do not mix different types of batteries or new and old batteries.

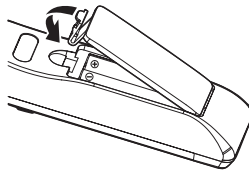

To ensure safe operation, please observe the following precautions :

- ▶ Use AAA/R03 type batteries.
- ▶ Avoid contact with water or liquid.
- ▶ Do not expose the remote control to moisture or heat.
- ▶ Do not drop the remote control.
- ▶ If the batteries have leaked in the remote control, carefully wipe the case clean and install new batteries.
- ▶ There is a risk of explosion if the batteries are replaced with the wrong type.
- ▶ Dispose of used batteries according to the instructions.
- ▶ Remove the batteries from the remote control when not using for extended periods.
- ▶ The remote control may fail to operate if the infrared remote sensor is exposed to bright sunlight or fluorescent lighting.

# User Controls

## Remote Control



AV Mute	Turns off audio and video until pressed again.
Re-Sync	Automatically synchronizes the projector to the input source.
Four Directional Select Keys	Use ▲▼◀▶ to navigate the menu and make selections. Can be used as computer mouse navigation from USB-A with Mouse Function enabled.
Menu	Launch the on-screen display (OSD) menu. Press again to exit OSD menu.
Keystone +/-	Adjust the image to compensate for distortion caused by tilting the projector.
VGA	Press to choose VGA source.
Video	Press to choose Video source.
HDMI	Press to cycle through all HDMI sources.
Page +/-	Use to send Page Up and Page Down functions with Mouse Function enabled.
Mouse	Turn on and off the Mouse Function.
Picture	Display the Picture Mode menu.
Power	Refer to the "Powering the Projector On / Off" section on pages 14-15.
Source	Select the input source.
Enter	Confirm your OSD selection. Can be used as computer mouse left click from USB-A when Mouse Function is enabled.
ECO	Display the Lamp "Brightness Mode" menu.
Volume +/-	Increase and decrease audio volume.
Aspect	Display the Aspect Ratio menu.
Zoom +/-	Increase or decrease the image magnification ratio.
Mute	Turns off audio until pressed again.
Freeze	Pauses the video source until pressed again.

## Using the HELP button

The HELP function ensures easy setup and operation.

- ▶ Press the ? button on the control panel to open the Help Menu.

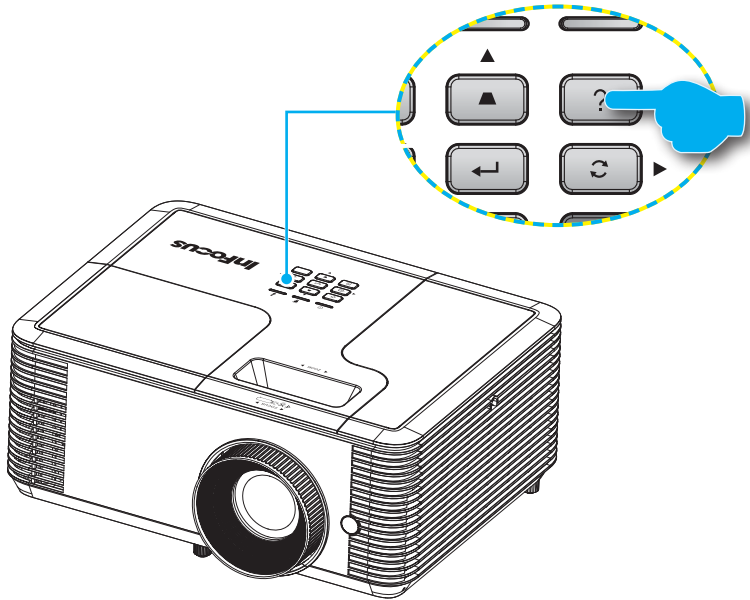

# User Controls

- ▶ If no input source is detected, these Help menu screens are displayed.



❖ Please refer to the “Troubleshooting” section on pages 61-64 for more details.

The first screenshot shows the HELP menu with the title 'HELP' and the message 'No Image appears on-screen'. It includes a navigation bar at the bottom with 'UpDown', 'Select', and 'Exit' options.

The second screenshot shows the same message with three troubleshooting steps:

- ▶ Ensure all the cables and power connections are correctly and securely connected as described in the Installation section of User Manual.
- ▶ Ensure all the pins of connectors are not bent or broken.
- ▶ Ensure that the [AV MUTE] feature is not turned on.

It also includes navigation options: [NEXT], [EXIT], and a bottom bar with 'UpDown', 'Select', and 'Exit'.

The third screenshot shows the message with instructions for notebook users:

- ▶ If you are using a Notebook:
  1. First, follow the steps above to adjust resolution of the computer.
  2. Press the toggle output settings. Example : [Fn]+[F4]

Acer	⇨	[Fn]+[F5]	IBM/Lenovo	⇨	[Fn]+[F5]
Asus	⇨	[Fn]+[F8]	HP/Compaq	⇨	[Fn]+[F5]
Dell	⇨	[Fn]+[F8]	NEC	⇨	[Fn]+[F5]
Gateway	⇨	[Fn]+[F4]	Toshiba	⇨	[Fn]+[F5]

Mac Apple :  
System Preference ⇨ Display ⇨ Arrangement ⇨ Mirror display

Navigation options: [PREV], [EXIT], and a bottom bar with 'UpDown', 'Select', and 'Exit'.

- ▶ If an input source is detected, these Help menu screens are displayed.

## VGA input signal:

The screenshot shows the HELP menu with the title 'HELP' and the message 'VGA input signal'. It includes a navigation bar at the bottom with 'UpDown', 'Select', and 'Exit' options.

- ▶ Image has slanted sides
- ▶ Image is too small or too large
- ▶ Image is unstable or flickering.

## Other signals (other than VGA input signal):

The screenshot shows the HELP menu with the title 'HELP' and the message 'Other signals (other than VGA input signal)'. It includes a navigation bar at the bottom with 'UpDown', 'Select', and 'Exit' options.

- ▶ Image has slanted sides
- ▶ Image is too small or too large

# User Controls

## Image has slanted sides

- ▶ If possible, reposition the projector so that is centered on the screen and below the bottom of the screen.
- ▶ Press [Keystone +/-] button until the sides are vertical on the remote control.

[Keystone +/-]

 [EXIT]

 Up/Down

 Select

 Menu Exit

## Image is too small or too large

- ▶ Adjust the Zoom Ring on the top of the projector.
- ▶ Move the projector closer to or further from the screen.
- ▶ Press [Menu] button on the remote control or projector panel, go to Display | Format and try the different settings.

[DISPLAY | Format]

 [EXIT]

 Up/Down

 Select

 Menu Exit

## Image is unstable or flickering.

- ▶ Use [Phase / Frequency] to correct it.
- ▶ Change the monitor color setting on your computer.

[Phase]

[Frequency]

 [EXIT]

 Up/Down

 Select

 Menu Exit

## On-screen Display Menus

The Projector has multilingual On-screen Display menus that allow you to make image adjustments and change a variety of settings. The projector will automatically detect the source.

### How to operate

1. To open the OSD menu, press “Menu” on the remote control or the control panel.
2. When the OSD is displayed, use ◀▶ keys to select any item in the main menu. While making a selection on a particular page, press ▲ or ▼ key to enter sub menu.
3. Use ▲ ▼ keys to select the desired item and adjust the settings using ◀▶ key.
4. Select the next item to be adjusted in the sub menu and adjust as described above.
5. Press “Enter” to confirm, and the screen will return to the previous menu.
6. To exit, press “Menu” again. The OSD menu will return to the previous menu and the projector will automatically save the new settings.

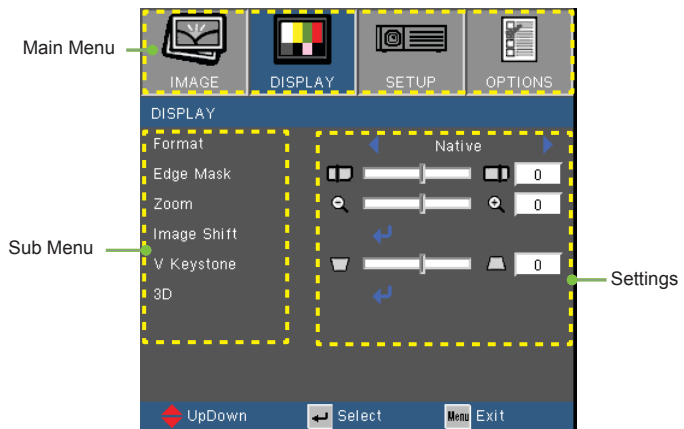



# User Controls

## Menu Tree

Main Menu	Sub Menu	Settings			
IMAGE	Picture Mode		Presentation/Bright/Movie/sRGB/Blackboard/User/3D		
	Brightness		-50~50		
	Contrast		-50~50		
	Sharpness		1~15		
	Color <sup>1</sup>		-50~50		
	Tint <sup>1</sup>		-50~50		
	Advanced	Gamma		Film/Video/Graphics/Standard	
		BrilliantColor™		1~10	
		Color Temp.		Warm/Medium/Cold	
		Color Settings	Red/Green/Blue/ Cyan/Magenta/ Yellow		Hue/Saturation/Gain
			White		Red/Green/Blue
			Reset		
			Exit		
		Color Space	Analog		AUTO/RGB/YUV
			HDMI		AUTO/RGB(0~255)/RGB(16~235)/YUV <sup>2</sup>
		Signal <sup>3</sup>	Automatic		On/Off
			Phase		0~31
			Frequency		-10~10
			H. Position		-5~5
	V. Position			-5~5	
Exit					
DISPLAY	Format <sup>4</sup>		4:3, 16:9, Native, Auto (for XGA models) 4:3, 16:9 or 16:10, LBX, Native, Auto (for WXGA/1080p models)		
	Edge Mask		0~10		
	Zoom		-5~25		
	Image Shift	H		-100~100	
		V		-100~100	
	V Keystone		-40~40 -20~20 <sup>5</sup>		
	3D	3D Mode		Off/DLP-Link/IR <sup>6</sup>	
		3D->2D		3D/L/R	
		3D Format <sup>7</sup>		AUTO/SBS/Top and Bottom/Frame Sequential	
		3D Sync. Invert <sup>7</sup>		On/Off	
Exit					

# User Controls

Main Menu	Sub Menu	Settings		
SETUP	Language		English / Deutsch / Français / Italiano / Español / Português / Polski / Nederlands / Hindi / Norsk / Dansk / Filipino / Malay / Romanian / 繁體中文 / 簡體中文 / 日本語 / 한국어 / Русский / Magyar / Čeština / عربي / ไทย / Türkçe / Farsi/ Vietnamese / Indonesian	
	Projection			
	Menu Location			
	Screen Type <sup>8</sup>		16:10/16:9	
	Audio Settings	Mute		On/Off
		Volume		0~10
		Audio Input		Default/AUDIO1
	Network <sup>9</sup>	Network State		
		DHCP		On/Off
		IP Address		
		Subnet mask		
		Gateway		
		DNS		
		Apply		
	Advanced	Exit		
		Logo		Default/Neutral
		Closed Captioning <sup>1</sup>		Off/CC1/CC2
OPTIONS	Input Source		VGA/Video/HDMI1/HDMI2/HDMI3	
	Source Lock		On/Off	
	High Altitude		On/Off	
	Information Hide		On/Off	
	Keypad Lock		On/Off	
	Test Pattern		Grid/White	
	IR Function		On/Off	
	Background Color		Black/Red/Blue/Green/White	
	12V Trigger <sup>10</sup>		On/Off/Auto 3D	
	Advanced	Direct Power On		On/Off
Auto Power Off (min)			0~180	



# User Controls

Main Menu	Sub Menu	Settings	
OPTIONS	Advanced	Sleep Timer (min)	0~990
		Quick Resume	On/Off
		Power Mode (Standby)	Active/Eco.
		Network (Standby)*11	On/Off
		VGA Out (Standby)*11	On/Off
		Exit	
	Lamp Settings	Lamp Hours	
		Lamp Reminder	On/Off
		Brightness Mode	Bright/Eco/Dynamic
		Lamp Reset	Yes/No
		Exit	
	Optional Filter Settings	Optional Filter Installed	Yes/No
		Filter Usage Hours	0~99999
		Filter Reminder	Off/300Hr/500Hr/800Hr/1000Hr
		Filter Reset	Yes/No
		Exit	
	Reset		Yes/No



❖ Please note that the on-screen display (OSD) menus vary according to the signal type selected and the projector model you are using.

- ❖ \*1 Supported only for Video sources.
- ❖ \*2 Supported only for HDMI sources.
- ❖ \*3 Supported only for Analog VGA sources.
- ❖ \*4 16:10 for WXGA models only, LBX for WXGA/1080p models only.
- ❖ \*5 Supported only for ST models.
- ❖ \*6 IR sync supported on 1080p models only.
- ❖ \*7 Only available when 3D is enabled.
- ❖ \*8 Supported on WXGA models only.
- ❖ \*9 Supported only for models with RJ-45.
- ❖ \*10 Screen trigger supported on 1080p models only.
- ❖ \*11 Supported only on projectors equipped with network function and only when Power Mode (Standby) is Active.

## IMAGE

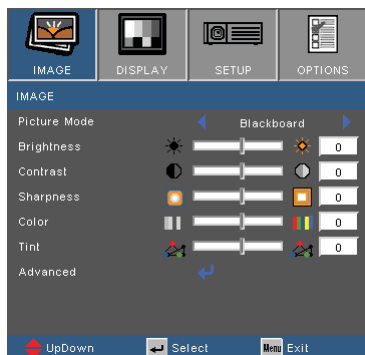

### Picture Mode

There are many factory presets optimized for various types of images.

- ▶ Presentation: Good color and brightness from PC input.
- ▶ Bright: Maximum brightness from PC input.
- ▶ Movie: For home theater.
- ▶ sRGB: Standardized accurate color.
- ▶ Blackboard: This mode should be selected to achieve optimum color settings when projecting onto a blackboard (green).
- ▶ User: User's settings.
- ▶ 3D: Recommended setting for when 3D function is enabled.

### Brightness

Adjust the brightness of the image.

- ▶ Press ◀ to darken image.
- ▶ Press ▶ to lighten the image.

### Contrast

The contrast controls the degree of difference between the lightest and darkest parts of the picture.

- ▶ Press ◀ to decrease the contrast.
- ▶ Press ▶ to increase the contrast.



NOTE

- ❖ “Color” and “Tint” are only supported for Video sources.

## Sharpness

Adjust the sharpness of the image.

- ▶ Press ◀ to decrease the sharpness.
- ▶ Press ▶ to increase the sharpness.

## Color

Adjust a video image from black and white to fully saturated color.

- ▶ Press ◀ to decrease the amount of saturation in the image.
- ▶ Press ▶ to increase the amount of saturation in the image.

## Tint

Adjust the color balance of red and green.

- ▶ Press ◀ to increase the amount of green in the image.
- ▶ Press ▶ to increase the amount of red in the image.

## IMAGE | Advanced

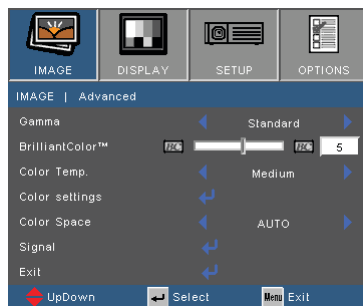

### Gamma

This allows you to choose a degamma table that has been fine-tuned to bring out the best image quality for the input.

- ▶ Film: for home theater.
- ▶ Video: for video or TV source.
- ▶ Graphics: for image source.
- ▶ Standard: for PC or computer source.

### BrilliantColor™



This adjustment utilizes a new color-processing algorithm and system level enhancements to enable higher brightness while providing true, more vibrant colors in the projected image. The range is from “1” to “10”. If you prefer a stronger enhanced image, adjust toward the maximum setting. For a smoother, more natural image, adjust toward the minimum setting.

### Color Temp

Select Cold for a bluer image.

Select Warm for a redder image.

### Color Settings

Press  to enter the menu shown below. Use  or  to select the color to be adjusted.

# User Controls

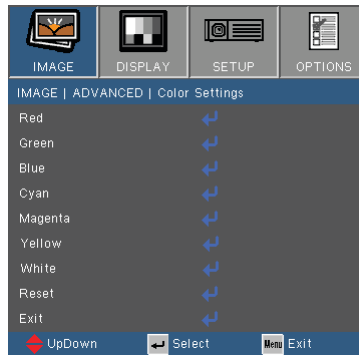

- ▶ Red/Green/Blue/Cyan/Magenta/Yellow: Use ▲ or ▼ to select the function. Use ◀ or ▶ to adjust.



- ▶ White: Use ▲ or ▼ to select the function. Use ◀ or ▶ to adjust.



- ▶ Reset: Choose “Yes” to return the factory default settings for color adjustments.



❖ (\*) For HDMI sources only.

## Color Space

Select an appropriate color matrix type from AUTO, RGB, RGB(0-255)<sup>(\*)</sup>, RGB(16-235)<sup>(\*)</sup> or YUV.

## IMAGE | Advanced | Signal

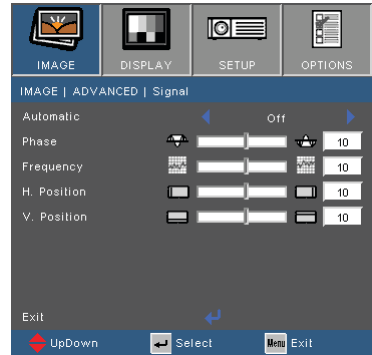

- ❖ “Signal” adjustments are only available for Analog VGA (RGB) sources.

### Automatic

Automatically selects the signal. If this function is turned on the manual phase and frequency controls will be disabled. When this option is disabled manual controls will be enabled and automatically saved when the device is powercycled.

### Phase

Synchronize the signal timing of the display with the graphics card. If the image appears to be unstable or flickers, use this function to correct it.

### Frequency

Change the display data frequency to match the frequency of your computer’s graphics card. Use this function only if the image appears to flicker vertically.

### H. Position

- ▶ Press ◀ to move the image left.
- ▶ Press ▶ to move the image right.

### V. Position

- ▶ Press ◀ to move the image down.
- ▶ Press ▶ to move the image up.

## DISPLAY



### Format

Use this function to choose your desired aspect ratio.

- ▶ 4:3: This format is for 4×3 input sources.
- ▶ 16:9: This format is for 16×9 input sources, like HDTV and DVD enhanced for Wide screen TV.
- ▶ 16:10 (only for WXGA models): This format is for 16:10 input sources, like widescreen laptops.
- ▶ Native: This format displays the original image without any scaling.
- ▶ LBX (for WXGA/1080p models): This format is for non-16x9, letterbox sources.
- ▶ Auto: Automatically selects the appropriate display format.



- ❖ Each I/O has different setting of “Edge Mask”.

### Edge Mask

Edge mask function removes the noise in a video image. Edge mask the image to remove video encoding noise on the edge of video sources.

# User Controls

## Zoom

- ▶ Press ◀ to reduce the size of an image.
- ▶ Press ▶ to magnify an image on the projection screen.

## Image Shift

Press ↵ to enter the menu then use ▲ or ▼ to select the function.



- ▶ H: Use ◀ or ▶ to shift the projected image position horizontally.
- ▶ V: Use ◀ or ▶ to Shift the projected image position vertically.

## V Keystone

Press ◀ or ▶ to adjust image distortion vertically. If the image looks trapezoidal, this option can help make the image rectangular.



## DISPLAY | 3D

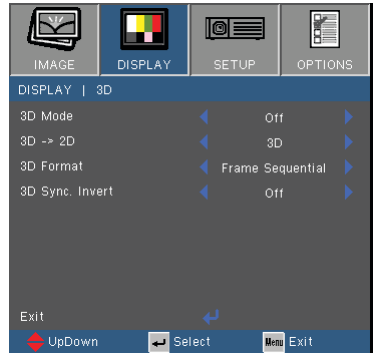

- ❖ Compatible 3D source, 3D content and active shutter glasses are required for 3D viewing.
- ❖ "3D Sync Invert" is only available for DLP Link glasses.
- ❖ IR sync is only available on 1080p models.
- ❖ See page 72 for supported 3D formats.

### 3D Mode

- ▶ Off: Select "Off" to turn 3D settings off for 3D images.
- ▶ DLP Link: Select "DLP Link" to use optimized settings for DLP Link 3D images.
- ▶ IR: Select "IR" to use optimized setting for IR 3D Glasses.

### 3D -> 2D

- ▶ 3D: Display 3D signal.
- ▶ L (Left): Display the left frame of 3D content.
- ▶ R (Right): Display the right frame of 3D content.

### 3D Format

- ▶ Auto: When a 3D identification signal is detected, the 3D format is selected automatically.
- ▶ SBS: Use this mode for "Side-by-side" format 3D content.
- ▶ Top and Bottom: Use this mode for "Top and Bottom" format 3D content.
- ▶ Frame Sequential: Use this mode for "Frame Sequential" format 3D content.

### 3D Sync. Invert

- ▶ Press "On" to invert left and right frame contents.
- ▶ Press "Off" for default frame contents.

## SETUP

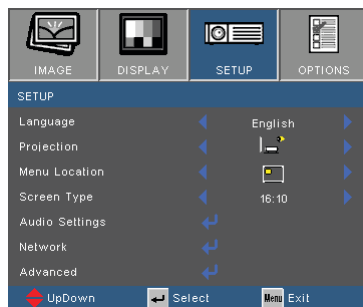





### Language

Choose the multilingual OSD menu. Press ◀ or ▶ to enter the "Language" menu then use ▲ or ▼ to select your preferred language. Press "Enter" to finalize the selection.



❖ Rear-Desktop and Rear-Ceiling are to be used with a translucent screen.

### Projection

- ▶  **Front-Desktop**  
This is the default selection. The image is projected straight on the screen.
- ▶  **Rear-Desktop**  
When selected, the image will appear reversed.
- ▶  **Front-Ceiling**  
When selected, the image will turn upside down.
- ▶  **Rear-Ceiling**  
When selected, the image will appear reversed in upside down position.



- ❖ "Screen Type" is available on WXGA models only.

## Menu Location

Choose the menu location on the display screen.

## Screen Type

Choose the screen type from 16:9 and 16:10.

## SETUP | Audio Settings

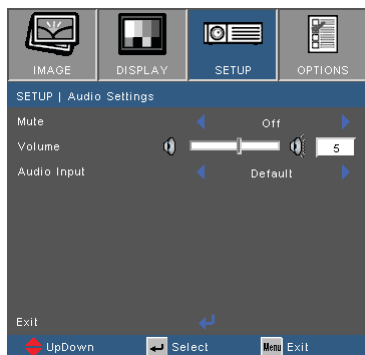

### Mute

- ▶ Choose “On” to turn mute on.
- ▶ Choose “Off” to turn mute off.

### Volume

- ▶ Press ◀ to decrease the volume.
- ▶ Press ▶ to increase the volume.

### Audio Input

- ▶ Default: Set audio input according to the current input source.
- ▶ AUDIO1: Audio In becomes the audio source for all video inputs.

## SETUP | Network



- ❖ Available only on projectors equipped with an RJ45 network connector.

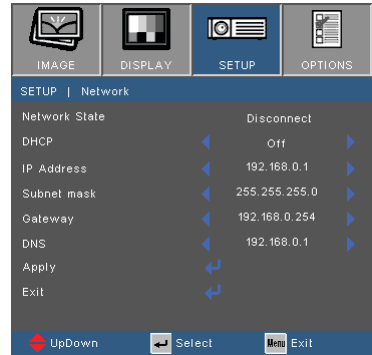

### Network State

Display the network connection status (read-only).

### DHCP

- ▶ On: Projectors will obtain an IP address automatically from your network. DHCP is on by default.
- ▶ Off: To assign IP, Subnet Mask, Gateway and DNS configuration manually.

### IP Address

Display the IP address.

### Subnet mask

Display Subnet mask number.

### Gateway

Display the default gateway of the network connected to the projector.

### DNS

Display DNS number.

### Apply

Save network settings.

### Exit

Choose “Exit” to exit the menu.

## SETUP | Advanced

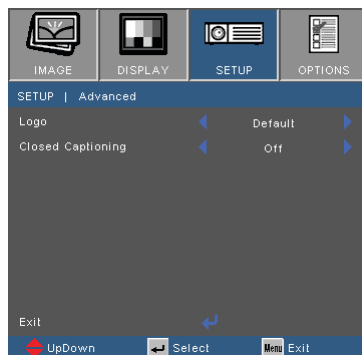

### Logo

Use this function to set the desired startup screen. If changes are made they will take effect the next time the projector is powered on.

- ▶ Default: The default startup screen.
- ▶ Neutral: Logo is not displayed on startup screen.

### Closed Captioning

Closed Captioning is a text version of the program sound or other information displayed on the screen. If the input signal contains closed captions, you can turn on the feature and watch the channels. Closed Captioning is only available for Video NTSC.

- ▶ Off: Select "Off" to turn off the closed captioning feature.
- ▶ CC1: Decodes American English captioning.
- ▶ CC2: Decodes (depending on the TV channel) Spanish, French, Portuguese, German or Danish captioning.

## OPTIONS

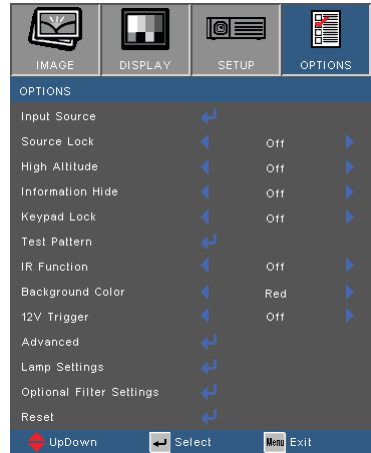

### Input Source

Use this option to enable / disable input sources. Press **←** to enter the sub menu and select which sources you require. Press "Enter" to finalize the selection. The projector will not search for inputs that are not selected.

### Source Lock

- ▶ On: The projector will only search the current input selection.
- ▶ Off: The projector will search for other signals if the current input signal is lost.

### High Altitude

When "On" is selected, the fans will spin faster. This feature is useful in high altitude areas where the air is thin.

### Information Hide

- ▶ On: Choose "On" to hide source message.
- ▶ Off: Choose "Off" to show source message.

### Keypad Lock

When the keypad lock function is "On", the control panel will be locked however, the projector can be operated by the remote control. By selecting "Off", you will be able to use the control panel once more.



- ❖ To turn off the keypad lock, press and hold "Enter" key on top of the projector for 5 seconds.

## Test Pattern

Display a test pattern. There are grid and white patterns.

## IR Function

- ▶ On: The projector can be operated by the remote control. When you change the setting from “Off” to “On”, it will display a warning message:

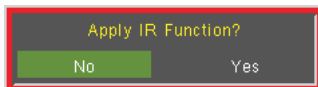

- ▶ Off: You will only be able to use the control panel keys. When you change the setting from “On” to “Off”, it will display a warning message:

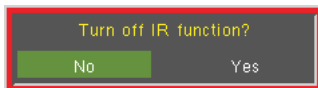

## Background Color

Use this feature to display a “Black”, “Red”, “Blue”, “Green” or “White”, screen when no signal is available.

## 12V Trigger

- ▶ On: The 12V Trigger will turn on when the lamp is lighted.
- ▶ Off: The 12V Trigger will not turn on in any state.
- ▶ Auto 3D: 12V Trigger output when the 3D Mode setting is set to DLP-Link or IR. Stop 12V output when the 3D Mode setting is set Off.

## Reset

Choose “Yes” to return the display parameters on all menus to the factory default settings.



## OPTIONS | Advanced

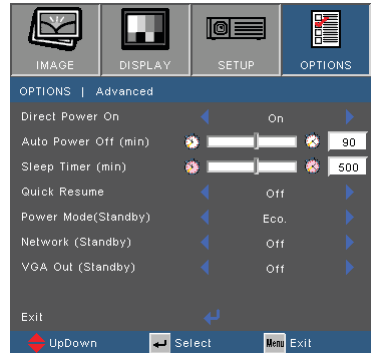

### Direct Power On

- ▶ On: The projector will automatically power on when AC power is applied.
- ▶ Off: The projector will turn on by pressing the “⏻” key on the remote or keypad.

### Auto Power Off (min)

Sets the countdown time interval in minutes. The countdown timer will start, when there is no signal being sent to the projector. The projector will automatically power off when the countdown has finished.

### Sleep Timer (min)

Sets the countdown time interval in minutes. The countdown timer will start, with or without a signal being sent to the projector. The projector will automatically power off when the countdown has finished.

### Quick Resume

- ▶ On: If the projector is accidentally turned off, this feature allows the projector to be instantly powered on again, if selected within a period of 100 seconds.
- ▶ Off: The fan will start cooling the system immediately when the user turns off the projector.

## Power Mode (Standby)

- ▶ Eco.: Sets standby power to <0.5W.
- ▶ Active: Network and VGA output functions are available in standby.

## Network (Standby)

- ▶ On: Network is available in standby.
- ▶ Off: Network is unavailable in standby.

## VGA Out (Standby)

- ▶ On: VGA Out is available in standby.
- ▶ Off: VGA Out is unavailable in standby.

## OPTIONS | Lamp Settings

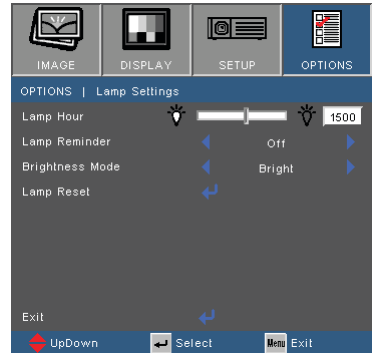

### Lamp Hours

Displays the lamp hours of the current lamp.

### Lamp Reminder

Choose this function to show or to hide the warning message when the changing lamp message is displayed.

The message will appear 30 hours before suggested replacement of the lamp.

### Brightness Mode

- ▶ Bright: Sets lamp to highest power for maximum brightness.
- ▶ Eco.: Decreases lamp power for less brightness and extended lamp life.
- ▶ Dynamic: Increases and decreases lamp power based on the video source. Power consumption will vary from maximum to 30%, extending lamp life.

### Lamp Reset

Resets the Lamp Hour counter. Should be used after replacing the lamp.



❖ When ambient temperature is over 40°C in operating, the projector will switch to Eco automatically.

## OPTIONS | Optional Filter Settings

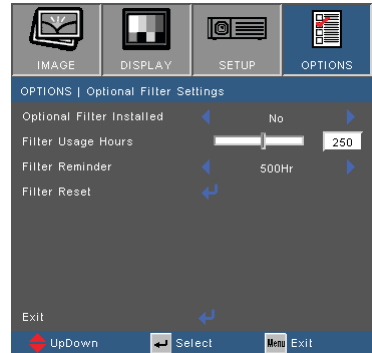

### Optional Filter Installed

Select “Yes” to display warning message after a specified number of hours. Select “No” to turn off warning message.

The default setting for Filter is “No”. After assembling filter, please turn on the projector then press “Menu”, go to “OPTIONS -> Optional Filter Settings -> Optional Filter Installed” and select “Yes”.

### Filter Usage Hours

Displays the filter hours.

### Filter Reminder

Select the number of hours until the filter message is displayed. (Factory default is 500Hr).

### Filter Reset

Reset the dust filter counter after replacing or cleaning the dust filter.

## Network Control

### Network Menu

#### How to enter the Network menu

1. Press the “Menu” button on the control panel or remote control.

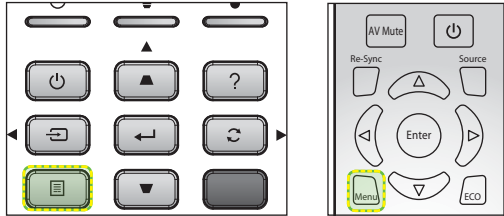

2. Press the ◀ or ▶ key to select the **SETUP** main menu.

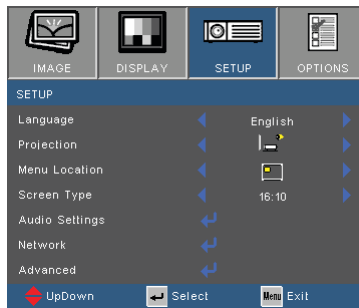

3. Press the ▲ or ▼ key to select Network item.

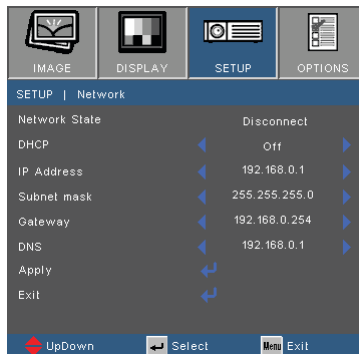

## Network Menu Functions

### Network State

Display the network connection status (read-only).

### DHCP

- ▶ On: Projector will obtain an IP address automatically from your network.
- ▶ Off: To assign IP, Subnet Mask, Gateway and DNS configuration manually.

### IP Address

Display and set the IP address.

### Subnet mask

Display and set the Subnet mask.

### Gateway

Display and set the Gateway IP address.

### DNS

Display and set the DNS address.

### Apply

Save network settings.

### Exit

Choose “Exit” to exit the menu.

# Appendices

## How to use web browser to control your projector via a router

1. Turn “On” the DHCP option on projector to allow a DHCP server to automatically assign an IP Address.
2. Open a web browser on your PC and enter the projector’s IP address in the URL window. The projector’s configuration web interface opens.
3. Enter the user name and password (default user name = admin, default password = admin) and click **Login**.



❖ The steps in this section are based on Windows 7 operating system.

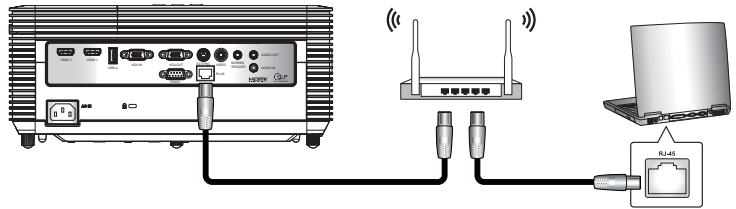

## Making a direct connection from your computer to the projector

1. Turn “Off” the DHCP option on the projector.
2. Configure the IP address, Subnet Mask, Gateway, and DNS on the projector (“Network”).
3. Open the **Network and Sharing Center** on your PC and assign an IP on the same subnet as the projector (first three numbers identical, fourth number different). Assign identical Subnet mask and gateway numbers. Click **OK** to save these parameters.

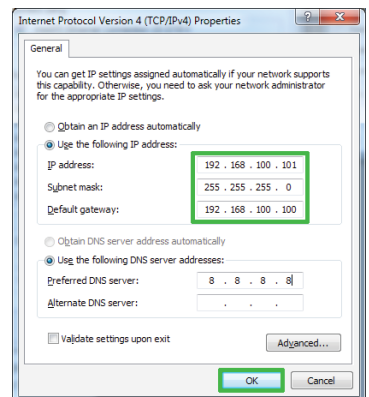
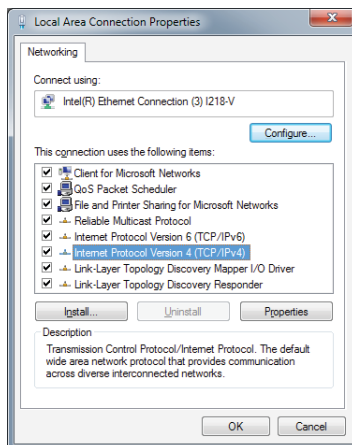

## Network Projector Control

1. Once the connection is configured and successful, open a browser on your computer and enter the projector IP address in the URL window. The projector IP address can be found in the Setup → Network section of the projector onscreen menu.



2. The Login page will be displayed. The projector can be controlled by the Crestron page without logging in. The default password is **admin**.

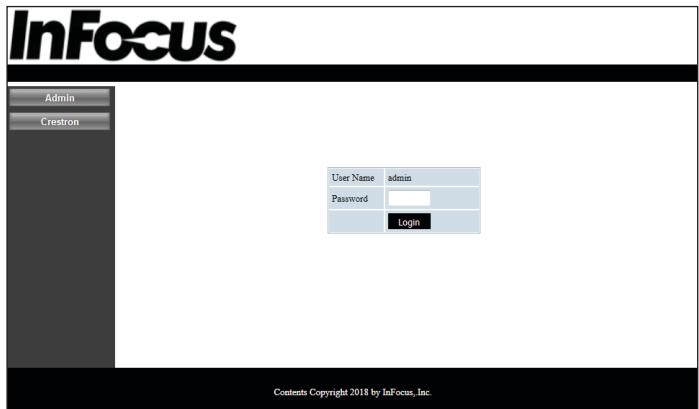



# Appendices

- The System Status page will be displayed after log in. All network features are accessible from the buttons on the left. Reset to Default resets all projector settings. Reboot system reboots the network interface, not the projector.

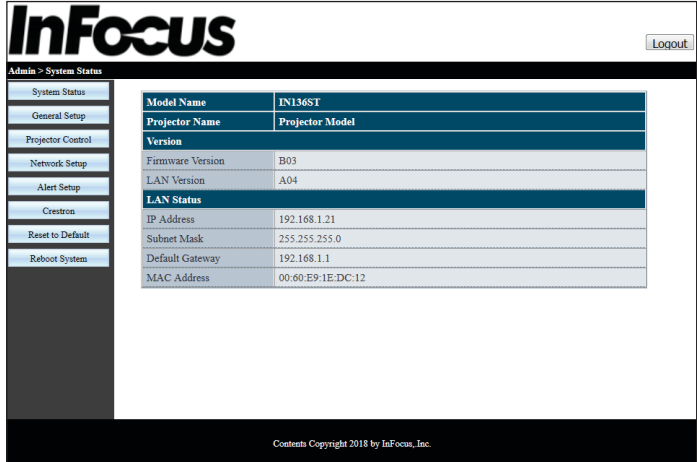

**InFocus** Logout

Admin > System Status

System Status	Model Name	IN136ST
General Setup	Projector Name	Projector Model
Projector Control	<b>Version</b>	
Network Setup	Firmware Version	B03
Alert Setup	LAN Version	A04
Crestron	<b>LAN Status</b>	
Reset to Default	IP Address	192.168.1.21
Reboot System	Subnet Mask	255.255.255.0
	Default Gateway	192.168.1.1
	MAC Address	00:60:E9:1E:DC:12

Contents Copyright 2018 by InFocus, Inc.

- The General Setup page allows changing the Projector Name and the admin password.

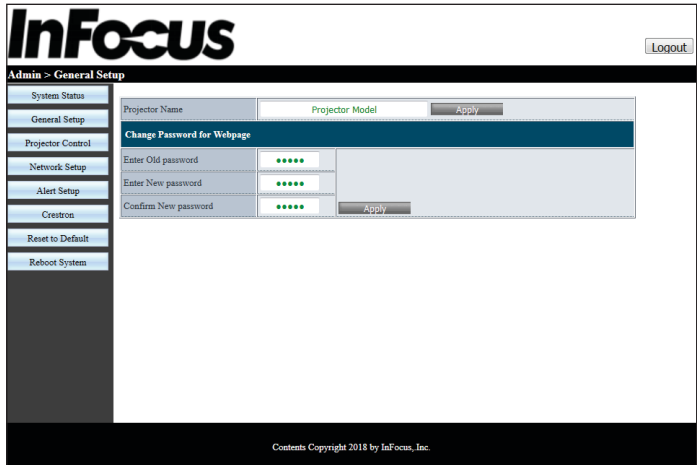

**InFocus** Logout

Admin > General Setup

System Status	Projector Name	Projector Model	Apply
General Setup	<b>Change Password for Webpage</b>		
Projector Control	Enter Old password	.....	
Network Setup	Enter New password	.....	
Alert Setup	Confirm New password	.....	Apply
Crestron			
Reset to Default			
Reboot System			

Contents Copyright 2018 by InFocus, Inc.

# Appendices

5. On the Projector Control page, you can perform many common network control functions such as changing the source and adjusting volume.

**InFocus** Logout

Admin > Projector Control

System Status  
General Setup  
**Projector Control**  
Network Setup  
Alert Setup  
Crestron  
Reset to Default  
Reboot System

Power On	Power Off	Mute	Off	Format	16:10
Resync	Reset	Volume(Audio)	0	Screen Type	16:10
AV Mute	Off	Source	HDMI 1	Projection	Front
Freeze	Off	Brightness	0	Zoom Value	0
Information Hide	Off	Contrast	0	Keystone	0
High Altitude	Off	BrilliantColor™	10	Background Color	Green
Keypad Lock	Off	Gamma	Film	Logo	Neutral
Direct Power On	Off	Color Temp	Warm	Power Mode	Active
		Picture Mode	Movie	Brightness Mode	Bright
		Color Space	Auto		

Contents Copyright 2018 by InFocus, Inc.

6. Network settings can be configured on the Network Setup page. If the IP address is changed the new IP address will have to be put in the url window of the browser to access Projector Control.

**InFocus** Logout

Admin > Network Setup

System Status  
General Setup  
Projector Control  
**Network Setup**  
Alert Setup  
Crestron  
Reset to Default  
Reboot System

IP Setup

Obtain an IP address automatically  Use the following IP address

IP Address	192	168	1	21
Subnet Mask	255	255	255	0
Default Gateway	192	168	1	1
DNS Server	192	168	1	1

Apply Reset

Contents Copyright 2018 by InFocus, Inc.

# Appendices

- Alert setup will send an email if there is a fault with the projector. Click the check boxes to enable notification and select which faults you want to have reported.

The screenshot shows the 'Admin - Alert Setup' web interface. On the left is a navigation menu with options: System Status, General Setup, Projector Control, Network Setup, Alert Setup, Crestron, Reset to Default, and Reboot System. The main area is titled 'Alert Setup' and contains several sections: 'Alert Type' with checkboxes for 'Fan Error', 'Lamp Error', and 'High Temp Warning'; 'Alert Mail Notification' with a checked checkbox; 'SMTP Setting' with fields for 'SMTP Server' (72.44.1.88), 'From' (thisprojector@mydesk.com), 'User Name' (ITperson@company.com), and 'Password' (masked); 'Email Setting' with fields for 'Mail Subject' (InFocusProjector Alert), 'Mail Content' (Projector Alert from projector in Room 222.), and 'To' (ITperson@company.com). There are 'Apply' and 'Send Test Mail' buttons at the bottom right. A footer note reads 'Contents Copyright 2018 by InFocus, Inc.'

- Crestron uses a standard interface for limited control of the projector. A new tab is opened in the browser when this function is selected.

The screenshot shows the Crestron remote control interface for the InFocus projector. At the top, it displays 'Model: InFocus' and navigation links for 'Tool', 'Info', and 'Contact IT Help'. The 'InFocus' logo is prominently displayed. Below the logo are buttons for 'Power', 'Vol -', 'Mute', and 'Vol +'. A 'Sources List' section shows a list of input sources: VGA, Video, HDMI 1 (highlighted), HDMI 2, and HDMI 3. To the right of the list are control buttons: 'Menu', 'Re-Sync', 'Enter', 'AV mute', and 'Source'. At the bottom, there are buttons for 'Freeze', 'Contrast', 'Brightness', and 'Sharpness'. The interface version '2.7.2.7' is noted in the top right corner, and the 'CRESTRON connected' logo and 'Expansion Options' are at the bottom.



## Troubleshooting

*If you experience a problem with your projector, please refer to the following information. If a problem persists, please contact your local reseller or service center.*

### **?** No image appears on-screen

- ▶ Ensure all the cables and power connections are correctly and securely connected as described in the “Installation” section.
- ▶ Ensure all the pins of connectors are not bent or broken.
- ▶ Ensure that the “AV Mute” feature is not turned on.
- ▶ Check if the projection lamp has been securely installed. Please refer to the “Replacing the lamp” section.

### **?** Partial, scrolling or incorrectly displayed image

- ▶ Press “Re-SYNC” on the remote control or control panel.
- ▶ If you are using a PC:

#### For Windows:

1. From the “Control Panel” select “Displays”.
2. Select “Change Display Settings”.
3. Verify that the display resolution is smaller than or equal to WUXGA (1920x1200).

# Appendices

- ▶ If you are using a laptop:
  1. First, follow the steps above to adjust resolution of the computer.
  2. Press the appropriate keys listed below for your notebook manufacturer to send signal out from notebook to projector.  
Example: [Fn]+[F4]

Acer ⇒	[Fn]+[F5]	IBM/Lenovo ⇒	[Fn]+[F5]
Asus ⇒	[Fn]+[F8]	HP/Compaq ⇒	[Fn]+[F5]
Dell ⇒	[Fn]+[F8]	NEC ⇒	[Fn]+[F5]
Gateway ⇒	[Fn]+[F4]	Toshiba ⇒	[Fn]+[F5]

Mac Apple:  
System Preference ⇒ Display ⇒ Arrangement ⇒ Mirror display

- ▶ If you experience difficulty changing resolutions or your monitor freezes, restart all equipment including the projector.

**[?]** The screen of the computer is not displaying your presentation

- ▶ If you are using a Notebook PC  
Some Notebook PCs may deactivate their own screens when a second display device is in use. Each has a different way to be reactivated. Refer to your computer's manual for detailed information.

**[?]** Image is unstable or flickering

- ▶ Use "Phase" to correct it. See page 38 for more information.
- ▶ Change the monitor color setting on your computer.

**[?]** Image has vertical flickering bar

- ▶ Use "Frequency" to make an adjustment. See page 38 for more information.
- ▶ Check and re-configure the display mode of your graphic card to make it compatible with the projector.

## **[?]** Image is out of focus

- ▶ Rotate the focus ring or turn the focus lever (for short-throw lens models) until the image is clear. See page 17.
- ▶ Make sure the projector screen is within the required distance for your model. See pages 18-23.

## **[?]** The image is stretched when displaying 16:9 DVD title

- ▶ When you play anamorphic DVD or 16:9 DVD, the projector will show the best image when the projector display mode is set to 16:9 in the OSD.
- ▶ If you play 4:3 format DVD titles, please change the format to 4:3 in the projector OSD.
- ▶ If the image is still stretched, you will also need to adjust the aspect ratio by referring to the following:
- ▶ Please setup the display format as 16:9 (wide) aspect ratio type on your DVD player.

## **[?]** Image is too small or too large

- ▶ Turn the zoom lever to zoom in or out. See page 17.
- ▶ Move the projector closer to or further from the screen.
- ▶ Press the “Menu” button on the remote control, go to “Display → Format” and try the different settings.



❖ Use of Keystone is not recommended.

## **[?]** Image has slanted sides

- ▶ If possible, reposition the projector so that it is horizontally centered on the screen and below the bottom of the screen.
- ▶ Press the “Keystone +/-” button on the remote control until the sides are vertical.
- ▶ Use “Display → V Keystone” from the OSD to make an adjustment. Use the ▲ and ▼ keys to make the adjustment from the keypad.

## **[?]** Image is reversed

- ▶ Select “SETUP → Projection” from the OSD and adjust the projection direction.

## **[?]** The projector stops responding to all controls

- ▶ Check that “Keypad Lock” is not activated by trying to control the projector with the remote control.
- ▶ If possible, turn off the projector, then unplug the power cord and wait at least 60 seconds before reconnecting power.

## **[?]** Blurry double image

- ▶ Enter the 3D control menu to switch “Off” the 3D feature if normal 2D images are blurry or double images.

## **[?]** Two images, side-by-side format

- ▶ Press “3D Format” button and switch to “SBS” for input signal is HDMI 1.3 3D 1080i side-by-side.

## **[?]** Image does not display in 3D

- ▶ Check if the 3D glasses are turned on.
- ▶ Make sure the batteries of the 3D glasses are not exhausted.
- ▶ When the input signal is HDMI 1.3 3D (1080i side-by-side half), press “3D Format” button and switch to “SBS”.

## **[?]** Lamp burns out or makes a popping sound

- ▶ When the lamp reaches its end of life, it will burn out and may make a loud popping sound. If this happens, the projector will not turn on until the lamp module has been replaced. To replace the lamp, follow the procedures in the “Replacing the Lamp” section on pages 67-68.



## LED indicators





Not lighted ⇨ ○

Lighted red ⇨ ●

Lighted blue ⇨ ●

Blinking red ⇨ ○●

Blinking blue ⇨ ○●

Message			
	On/Standby LED (Blue/Red)	Temp LED (Red)	Lamp LED (Red)
Standby State	●	○	○
Power on (Warming)	○●	○	○
Lamp lighting	●	○	○
Power off (Cooling)	○●	○	○
Error (Over Temp.)	○●	●	○
Error (Fan fail)	○●	○●	○
Error (Lamp fail)	○●	○	●

## **?** On Screen Messages

### ▶ Temperature warning:

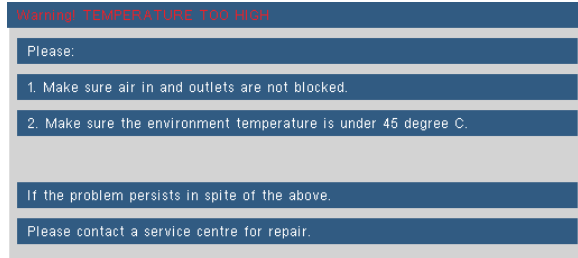

### ▶ Fan failed:

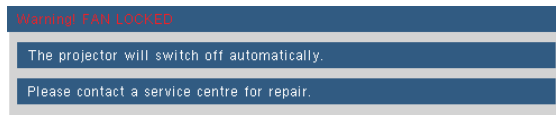

### ▶ Lamp warning:

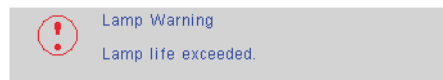

### ▶ Out of display range:



## **?** If the remote control does not work

- ▶ Verify that the angle of the remote to the IR receiver is within  $\pm 20$  degrees.
- ▶ Make sure there are not any obstructions between the remote control and the projector. Move to within 7m of the projector.
- ▶ Make sure the batteries are inserted correctly.
- ▶ Replace batteries if they are exhausted.
- ▶ Turn off any fluorescent lights that are illuminating the IR receiver.
- ▶ Make sure that IR Function is turned On in the Options menu.

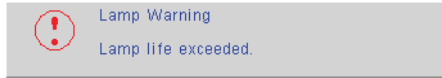

## Replacing the Lamp

The projector automatically detects the lamp life. When the lamp life is nearing the end of use, you will receive a warning message.



When you see this message, please contact your local reseller or service center to change the lamp as soon as possible. Make sure the projector has been cooled down for at least 30 minutes before changing the lamp.



-  Warning: If ceiling mounted, please use caution when opening the lamp access panel. It is recommended to wear safety glasses if changing the bulb when ceiling mounted. “Caution must be used to prevent any loose parts from falling out of projector.”
-  Warning: Lamp compartment may be hot! Allow it to cool down before changing the lamp!
-  Warning: To reduce the risk of personal injury, do not drop the lamp module or touch the lamp bulb. The bulb may shatter and cause injury if it is dropped.

# Appendices



- ❖ The screws on the lamp cover and the lamp cannot be removed.
- ❖ The projector cannot be turned on if the lamp cover has not been placed back on the projector.
- ❖ Do not touch the glass area of the lamp. Skin oils can cause the lamp to shatter. Use a dry cloth to clean the lamp module if it was accidentally touched.

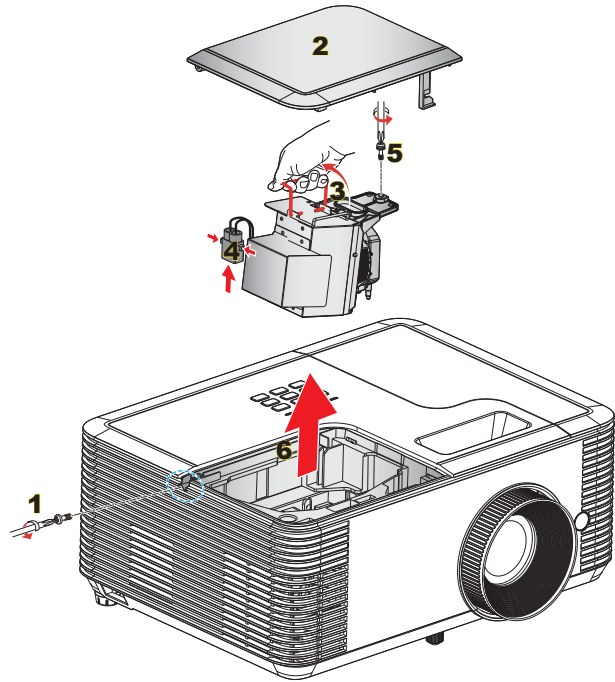

## ○ Lamp Replacement Procedure: ○

1. Switch off the power to the projector by pressing the “**⏻**” button.
  2. Allow the projector to cool down for at least 30 minutes.
  3. Disconnect the power cord.
  4. Unscrew the one screw on the cover. **1**
  5. Lift up and remove the cover. **2**
  6. Lift up the lamp handle. **3**
  7. Press on the both sides then lift up and remove the lamp cord. **4**
  8. Unscrew the one screw on the lamp module. **5**
  9. Remove the lamp module slowly and carefully. **6**
- To replace the lamp module, reverse the previous steps.
10. Turn on the projector and reset the lamp timer.

Lamp Reset: (i) Press “Menu” → (ii) Select “OPTIONS” → (iii) Select “Lamp Settings” → (iv) Select “Lamp Reset” → (v) Select “Yes”.

## Installing and Cleaning the Optional Dust Filter



❖ Dust filters are only required/ supplied in selected regions with excessive dust.

### Installing the Dust Filter

Procedure:

1. Place the dust filter onto its compartment on the filter cover.
2. Install the filter cover onto its slot on the projector.
3. Turn on the projector. Then press “Menu”, go to “OPTIONS -> Optional Filter Settings -> Optional Filter Installed” and select “Yes”.

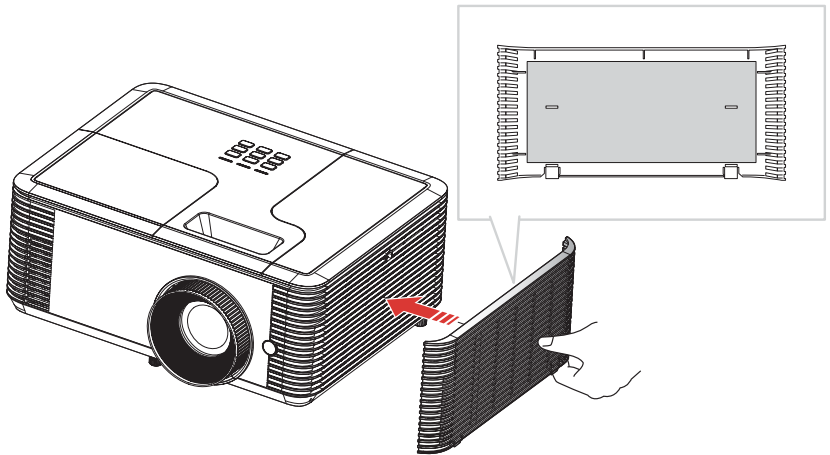

## Cleaning the Dust Filter

We recommend cleaning the dust filter every three months; clean it more often if the projector is used in a dusty environment.

Procedure:

1. Switch off the power to the projector by pressing the “**⏻**” button.
2. Disconnect the power cord.
3. Remove the filter cover from the projector. **1**
4. Remove the dust filter from the filter cover. **2**
5. Clean or replace the dust filter. **3**
6. To install the dust filter, reverse the previous steps.
7. Reset the dust filter counter after replacing or cleaning the dust filter. Press “Menu”, go to “OPTIONS -> Optional Filter Settings -> Filter Reset”.

Turn on the projector, then press “Menu”, “OPTIONS -> Optional Filter Settings -> Optional Filter Installed” and select “No” when you pull out the dust filter and do not reinstall it.

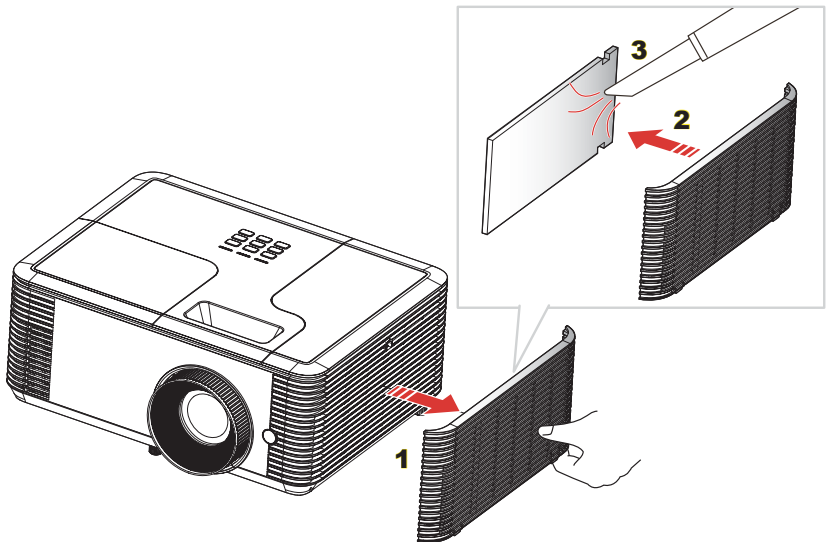

## Compatibility Modes

### ► Computer/Video/HDMI/Mac Compatibility



- ❖ For widescreen resolution, the compatibility support is dependent on Notebook/PC models.
- ❖ Please note that using resolutions other than native 800 x 600 (SVGA model), 1024 x 768 (XGA model), may result in some loss of image clarity.
- ❖ 120Hz input signals may be dependent on graphic card's support.

Signal	Resolution	Refresh Rate (Hz)	Video	Analog	HDMI	Mac
NTSC	720 x 480	60	O	-	-	-
PAL/SECAM	720 x 576	50	O	-	-	-
VGA	640 x 480	60	-	O	O	O
	640 x 480	67	-	O	-	-
	640 x 480	72.8	-	O	-	O
	640 x 480	85	-	O	-	O
SVGA	800 x 600	56.3	-	O	-	-
	800 x 600	60.3	-	O	O	O
	800 x 600	72.2	-	O	O	O
	800 x 600	85.1	-	O	O	O
	800 x 600	120	-	O	O	-
XGA	1024 x 768	48	-	O	O	
	1024 x 768	50	-	O	O	
	1024 x 768	60	-	O	O	O
	1024 x 768	70.1	-	O	O	O
	1024 x 768	75	-	O	O	O
	1024 x 768	85	-	O	O	O
	1024 x 768	120	-	O	O	-
WSVGA	1024 x 600	60	-	-	O	-
HDTV (720p)	1280 x 720	50	O	O	O	-
	1280 x 720	60	O	O	O	O
	1280 x 720	120	-	O	O	-
SXGA	1280 x 1024	60	-	O	O	O
	1280 x 1024	75	-	O	O	O
	1280 x 1024	85	-	O	O	-
SXGA+	1400 x 1050	60	-	O	O	-
UXGA	1600 x 1200	60	-	O	O	-
HDTV (1080p)	1920 x 1080	24	O	O	O	-
	1920 x 1080	30	-	-	O	-
	1920 x 1080	50	O	O	O	-
	1920 x 1080	60	O	O	O	O
HDTV (1080i)	1920 x 1080	50	O	-	O	-
	1920 x 1080	60	O	-	O	-

# Appendices

Signal	Resolution	Refresh Rate (Hz)	Video	Analog	HDMI	Mac
WUXGA	1920 x 1200	50	-	○	○	-
	1920 x 1200	60	-	○	○	○
SDTV (576i)	720 x 576	50	○	-	○	-
SDTV (576p)	720 x 576	50	○	-	○	-
SDTV (480i)	720 x 480	60	○	-	○	-
SDTV (480p)	720 x 480	60	○	-	○	-

## ▶ 3D Input Video Compatibility

Input Resolution	HDMI 1.4a 3D Input	Input Timing		
		1280 x 720p @ 50Hz	Top-and-Bottom	
	1280 x 720p @ 60Hz	Top-and-Bottom		
	1280 x 720p @ 50Hz	Frame packing		
	1280 x 720p @ 60Hz	Frame packing		
	1920 x 1080i @ 50 Hz	Side-by-Side (Half)		
	1920 x 1080i @ 60 Hz	Side-by-Side (Half)		
	1920 x 1080p @ 24 Hz	Top-and-Bottom		
	1920 x 1080p @ 24 Hz	Frame packing		
Input Resolution	HDMI 1.3 3D Content	1920 x 1080i @ 50Hz	Side-by-Side (Half)	While 3D Format is "SBS"
		1920 x 1080i @ 60Hz		
		1280 x 720p @ 50Hz		
		1280 x 720p @ 60Hz		
		1920 x 1080i @ 50Hz	Top-and-Bottom	While 3D Format is "Top and Bottom"
		1920 x 1080i @ 60Hz		
		1280 x 720p @ 50Hz		
		1280 x 720p @ 60Hz		
	480i	HQFS	While 3D Format is "Frame sequential"	



## RS232 Commands and Protocol Function List

### RS232 Pin Assignments

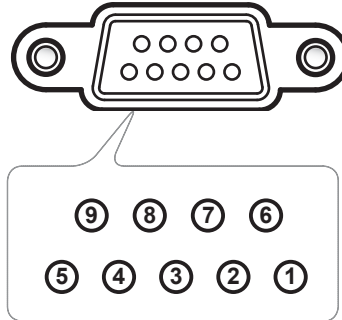

Pin no.	Spec. (from projector side)
1	N/A
2	RXD
3	TXD
4	N/A
5	GND
6	N/A
7	N/A
8	N/A
9	N/A

# Appendices

## RS232 Protocol Function List

Baud Rate:19200  
 Parity Bit: None  
 Data Bit: 8  
 Stop Bit: 1  
 Lamp Ignition delay = 20s  
 Power Down delay = 10s  
 Source change delay = 8s  
 Intercommand delay minimum = 5ms  
 Intercharacter delay minimum = 2ms

Power		return code (ok)
Status ?	(PWR?)	(0-1,n) n=0,1
ON	(PWR1)	
OFF	(PWR0)	
ON & return	(PWR1!)	(0-1,1)
OFF & return	(PWR0!)	(0-1,0)
Blank Key		return code (ok)
Status ?	(BLK?)	(0-1,n) n=0,1
ON	(BLK1)	
OFF	(BLK0)	
ON & return	(BLK1!)	(0-1,1)
OFF & return	(BLK0!)	(0-1,0)
Source		return code (ok)
Status ?	(SRC?)	(0-22,n) n=0-22
Computer1	(SRC0)	
VIDEO	(SRC11)	
HDMI1	(SRC4)	
HDMI2	(SRC5)	
HDMI3	(SRC6)	
Computer1 & return	(SRC0!)	(0-22,0)
VIDEO & return	(SRC11!)	(0-22,11)
HDMI1 & return	(SRC4!)	(0-22,4)
HDMI2 & return	(SRC5!)	(0-22,5)
HDMI3 & return	(SRC6!)	(0-22,6)

# Appendices

Aspect		return code (ok)
Status ?	(ARZ?)	(0-6,n) n=0,1,2,3,4,6
Auto	(ARZ0)	
Native	(ARZ1)	
4 X 3	(ARZ2)	
16 X 9	(ARZ3)	
Letterbox	(ARZ4)	
16 X 10	(ARZ6)	
Auto & return	(ARZ0!)	(0-6,0)
Native & return	(ARZ1!)	(0-6,1)
4 X 3 & return	(ARZ2!)	(0-6,2)
16 X 9 & return	(ARZ3!)	(0-6,3)
Letterbox & return	(ARZ4!)	(0-6,4)
16 X 10 & return	(ARZ6!)	(0-6,6)
Lamp Low Power(ECO Mode)		return code (ok)
Status ?	(IPM?)	(0-1,n) n=0,1
ON	(IPM1)	
OFF	(IPM0)	
ON & return	(IPM1!)	(0-1,1)
OFF & return	(IPM0!)	(0-1,0)
Volume		return code (ok)
Status ?	(VOL?)	(0-10,nn) n=0~10
volume +	(VOL+)	
volume -	(VOL-)	
Set volume	(VOLnn) n=0 ~ 10	
volume + & return	(VOL+!)	(0-10,nn) n=0~10
volume - & return	(VOL-!)	(0-10,nn) n=0~10
Set volume & return	(VOLnn!) n=0 ~ 10	(0-10,nn) n=0~10
Mute		return code (ok)
Status ?	(MTE?)	(0-1,n) n=0,1
ON	(MTE1)	
OFF	(MTE0)	
ON & return	(MTE1!)	(0-1,1)
OFF & return	(MTE0!)	(0-1,0)
Firmware Version		return code (ok)
Status ?	(FVS?)	(nnnn) n=x.x.xx

# Appendices

<b>Lamp ECO Hours</b>		<b>return code (ok)</b>
Status ?	(LME?)	(0-65535,n) n=lamp hours
<b>Lamp Normal Hours</b>		<b>return code (ok)</b>
Status ?	(LMO?)	(0-65535,n) n=lamp hours
<b>Lamp Dynamic Hours</b>		<b>return code (ok)</b>
Status ?	(LML?)	(0-65535,n) n=lamp hours
<b>Lamp Hours</b>		<b>return code (ok)</b>
Status ?	(LMP?)	(0-65535,n) n=lamp hours
<b>Total ECO Hours</b>		<b>return code (ok)</b>
Status ?	(LTE?)	(0-65535,n) n=lamp hours
<b>Total Normal Hours</b>		<b>return code (ok)</b>
Status ?	(LTO?)	(0-65535,n) n=lamp hours
<b>Total Dynamic Hours</b>		<b>return code (ok)</b>
Status ?	(LTL?)	(0-65535,n) n=lamp hours
<b>Total Hours</b>		<b>return code (ok)</b>
Status ?	(LMT?)	(0-65535,n) n=lamp hours
<b>Lamp Hours Reset Times</b>		<b>return code (ok)</b>
Status ?	(LMR?)	(0-65535,n) n=lamp reset times
<b>Lamp hours reset</b>		<b>return code (ok)</b>
Execute lamp hour reset	(LRT1)	
<b>Ceiling Set</b>		<b>return code (ok)</b>
Status ?	(CEL?)	(0-3,n) n=0,1,2,3
Front table	(CEL0)	
Front ceiling	(CEL1)	
rear table	(CEL2)	
rear ceiling	(CEL3)	
Front table & return	(CEL0!)	(0-3,0)
Front ceiling & return	(CEL1!)	(0-3,1)
rear table & return	(CEL2!)	(0-3,2)
rear ceiling & return	(CEL3!)	(0-3,3)
<b>Brightness</b>		<b>return code (ok)</b>
Status ?	(BRT?)	(0-100,nn) n=0~100
Brightness +	(BRT+)	
Brightness -	(BRT-)	
Set Brightness	(BRTnn) n=0 ~ 100	
Brightness + & return	(BRT+!)	(0-100,nn) n=0~100
Brightness - & return	(BRT-!)	(0-100,nn) n=0~100
Set Brightness & return	(BRTnn!) n=0 ~ 100	(0-100,nn) n=0~100

# Appendices

Contrast		return code (ok)
Status ?	(CON?)	(0-100,nn) n=0~100
Contrast +	(CON+)	
Contrast -	(CON-)	
Set Contrast	(CONnn) n=0 ~ 100	
Contrast + & return	(CON+!)	(0-100,nn) n=0~100
Contrast - & return	(CON-!)	(0-100,nn) n=0~100
Set Contrast & return	(CONnn!) n=0 ~ 100	(0-100,nn) n=0~100
Presets		return code (ok)
Status ?	(PST?)	(0-13,n) n=0-13
User	(PST1)	
Presentation	(PST5)	
Movie	(PST7)	
Bright	(PST10)	
sRGB	(PST11)	
Blackboard	(PST12)	
User & return	(PST1!)	(0-13,1)
Presentation & return	(PST5!)	(0-13,5)
Movie & return	(PST7!)	(0-13,7)
Bright & return	(PST10!)	(0-13,10)
sRGB & return	(PST11!)	(0-13,11)
Blackboard & return	(PST12!)	(0-13,12)
Freeze		return code (ok)
Status ?	(FRZ?)	(0-1,n) n=0-1
Freeze ON	(FRZ1)	
Freeze OFF	(FRZ0)	
Freeze ON & return	(FRZ1!)	(0-1,1)
Freeze OFF & return	(FRZ0!)	(0-1,0)

# Appendices

Key Pad		return code (ok)
Menu	(NAV0)	
Up	(NAV1)	
Down	(NAV2)	
Select	(NAV3)	
Left	(NAV4)	
Right	(NAV5)	
Menu & return	(NAV0!)	(0-5,0)
Up & return	(NAV1!)	(0-5,1)
Down & return	(NAV2!)	(0-5,2)
Select & return	(NAV3!)	(0-5,3)
Left & return	(NAV4!)	(0-5,4)
Right & return	(NAV5!)	(0-5,5)

## Ceiling Mount Installation

To prevent damage to your projector, please use only approved InFocus ceiling mounts:

<https://www.infocus.com/accessories/mounts>

To use a ceiling mount, please ensure the screws used to attach a mount to the projector meet the following specifications:

- ▶ Screw type: M4\*3
- ▶ Minimum screw length: 10mm



❖ Please note that damage resulting from incorrect installation will void the warranty.



Warning:

1. Please be sure to use the correct screw length. Screw length will vary based on the mount used.
2. Be sure to keep at least 10 cm gap between the ceiling and the bottom of the projector.
3. Avoid installing the projector near a heat source.

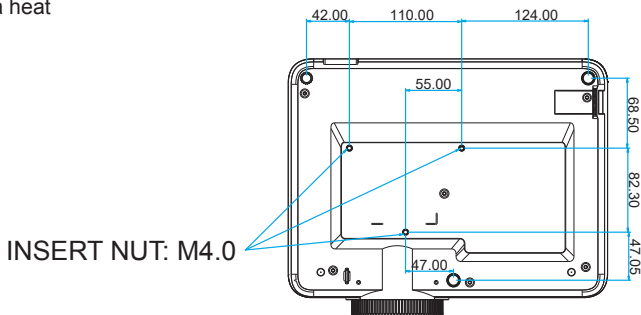
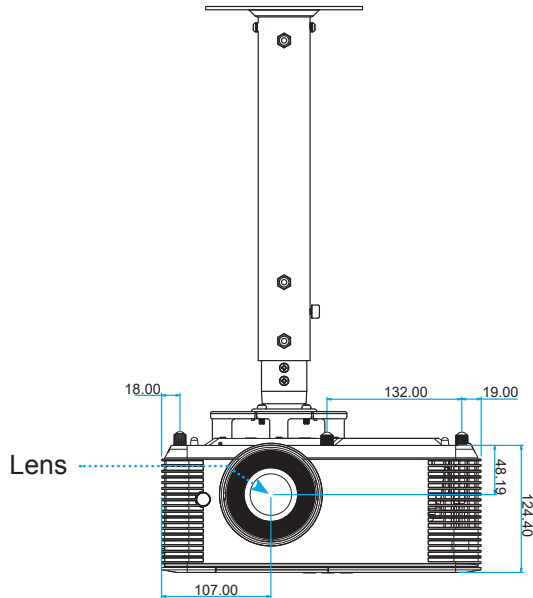

Unit: mm

# Appendices

## Short-throw lens models

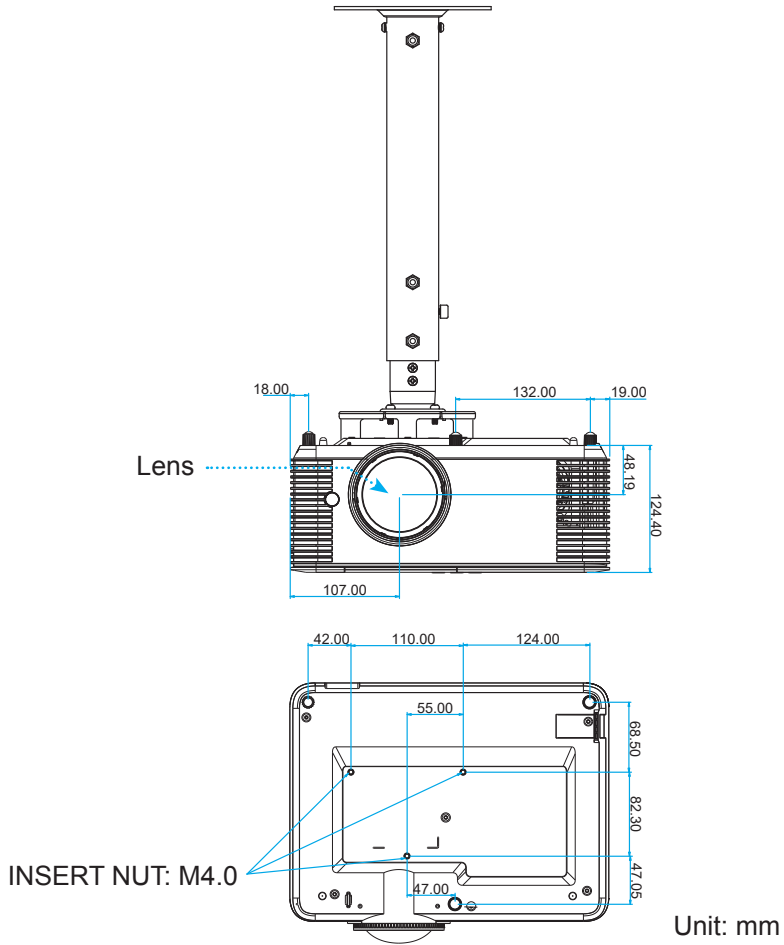



## Regulation & Safety Notices

*This appendix lists the general notices for your projector.*

### **FCC Notice**

This device has been tested and found to comply with the limits for a Class B digital device pursuant to Part 15 of the FCC rules. These limits are designed to provide reasonable protection against harmful interference in a residential installation. This device generates, uses and can radiate radio frequency energy and, if not installed and used in accordance with the instructions, may cause harmful interference to radio communications.

However, there is no guarantee that interference will not occur in a particular installation. If this device does cause harmful interference to radio or television reception, which can be determined by turning the device off and on, the user is encouraged to try to correct the interference by one or more of the following measures:

- ❖ Reorient or relocate the receiving antenna.
- ❖ Increase the separation between the device and receiver.
- ❖ Connect the device into an outlet on a circuit different from that to which the receiver is connected.
- ❖ Consult the dealer or an experienced radio/television technician for help.

### **Notice: Shielded cables**

All connections to other computing devices must be made using shielded cables to maintain compliance with FCC regulations.

### **Caution**

Changes or modifications not expressly approved by the manufacturer could void the user's authority, which is granted by the Federal Communications Commission, to operate this projector.

## **Operation Conditions**

This device complies with Part 15 of the FCC Rules. Operation is subject to the following two conditions:

1. This device may not cause harmful interference and
2. This device must accept any interference received, including interference that may cause undesired operation.

## **Notice: Canadian users**

This Class B digital apparatus complies with Canadian ICES-003.

## **Remarque à l'intention des utilisateurs canadiens**

Cet appareil numérique de la classe B est conforme à la norme NMB-003 du Canada.

## **Declaration of Conformity for EU countries**

- EMC Directive 2014/30/EU
- Low Voltage Directive 2014/35/EU

## **Disposal instructions**



**Do not throw this electronic device into the trash when discarding. To minimize pollution and ensure utmost protection of the global environment, please recycle it.**