

Projector

PH3501QL/PH2601QL

powered by NP-LV01BD

User's Manual

Please visit our web site for User's Manual in the latest version:

https://www.nec-display.com/dl/en/pj_manual/lineup.html

Model No.

NP-PH3501QL, NP-PH2601QL, NP-LV01BD

This device is used in combination with the LV kit (NP-LV01BD, sold separately) and the projector main unit. The picture sent from the connected device is then projected onto the screen. Note that it cannot be used with just the projector main unit.
This User's Manual explains mainly operation of the PH3501QL used in combination with NP-LV01BD.

- Apple, Mac, and MacBook are trademarks of Apple Inc. registered in the U.S. and other countries.
- Microsoft, Windows, and PowerPoint are either a registered trademark or trademark of Microsoft Corporation in the United States and/or other countries.
- Cinema Quality Picture logo, NaViSet and Virtual Remote are trademarks or registered trademarks of NEC Display Solutions, Ltd. in Japan, in the United State and other countries.
- The terms HDMI and HDMI High-Definition Multimedia Interface, and the HDMI Logo are trademarks or registered trademarks of HDMI Licensing Administrator, Inc. in the United States and other countries.



- DisplayPort and DisplayPort Compliance Logo are trademarks owned by the Video Electronics Standards Association in the United States and other countries.



- HDBaseT™ and the HDBaseT Alliance logo are trademarks of the HDBaseT Alliance.









- DLP® and the DLP logo are trademarks or registered trademarks of Texas Instruments in the United States and other countries.
- PLink trademark and logo are trademarks applied for registration or are already registered in Japan, the United States of America and other countries and areas.
- Blu-ray is a trademark of Blu-ray Disc Association.
- Extron and XTP are registered trademarks of RGB Systems, Inc. in the United States.
- Ethernet is either a registered trademark or trademark of Fuji Xerox Co., Ltd.
- Other product and company names mentioned in this user's manual may be the trademarks or registered trademarks of their respective holders.
- Virtual Remote Tool uses WinI2C/DDC library, © Nicomsoft Ltd.

NOTES

- (1) The contents of this user's manual may not be reprinted in part or whole without permission.
- (2) The contents of this user's manual are subject to change without notice.
- (3) Great care has been taken in the preparation of this user's manual; however, should you notice any questionable points, errors or omissions, please contact us.
- (4) Notwithstanding article (3), NEC will not be responsible for any claims on loss of profit or other matters deemed to result from using the Projector.

Important Information

	This symbol warns the user that uninsulated voltage within the unit may have sufficient magnitude to cause electric shock. Therefore, it is dangerous to make any kind of contact with any part inside of this unit.
	This symbol alerts the user that important literature concerning the operation and maintenance of this unit has been included. Therefore, it should be read carefully in order to avoid any problems.
	This symbol indicates something that must be prohibited.
	This symbol indicates something that must not be broken down.
	This symbol indicates something that must be paid attention to.

 CAUTION
TO PREVENT ELECTRIC SHOCK, DO NOT OPEN TOP COVER. NO USER SERVICEABLE PARTS INSIDE.



Laser Safety Caution

This product is classified as Class 1 of IEC60825-1 Third edition 2014. This product is classified as RG3 of IEC62471-5 First edition 2015. This product is classified as RG3 of IEC62471:2006 (for USA). Obey the laws and regulations of your country in relation to the installation and management of the device.

 CAUTION
Use of controls or adjustments of procedures other than those specified herein may lead to hazardous laser radiation exposure.

- Hazardous optical radiation is emitted from this product, RG3 IEC 62471:2006 (for USA).
- No direct exposure to the beam shall be permitted, RG3 IEC 62471-5:2015.



Do not do it

- Do not look into the lens while the projector is on. Serious damage to your eyes could result.



- Keep any items such as magnifying glass out of the light path of the projector. The light being projected from the lens is extensive, therefore any kind of abnormal objects that can redirect light coming out of the lens, can cause unpredictable outcome such as fire or injury to the eyes.
- When turning on the projector, ensure that nobody is facing towards the lens in the path of the light emitted from the laser.

DOC Compliance Notice (for Canada only)

This Class A digital apparatus meets all requirements of the Canadian ICES-003 Standards.

Machine Noise Information Regulation - 3. GPSGV,

The highest sound pressure level is less than 70 dB (A) in accordance with EN ISO 7779.



WARNING

This equipment is compliant with Class A of CISPR 32. In a residential environment this equipment may cause radio interference.

CAUTION

In order to reduce any interference with radio and television reception use a signal cable with ferrite core attached. Use of signal cables without a ferrite core attached may cause interference with radio and television reception.

This equipment has been tested and found to comply with the limits for a Class A digital device, pursuant to Part 15 of the FCC Rules. These limits are designed to provide reasonable protection against harmful interference when the equipment is operated in a commercial environment. This equipment generates, uses, and can radiate radio frequency energy and, if not installed and used in accordance with the installation manual, may cause harmful interference to radio communications. Operation of this equipment in a residential area is likely to cause harmful interference in which case the user will be required to correct the interference at his own expense.

WARNING



Do not disassemble

THE END USER IS NOT ALLOWED TO OPEN OR MODIFY THE PRODUCT.
NO USER SERVICEABLE PARTS.
MAINTENANCE AND SERVICE OF THE PRODUCT IS ONLY TO BE HANDLED BY NEC AUTHORIZED TECHNICIANS.

Important Safeguards

These safety instructions are to ensure the long life of your projector and to prevent fire and shock. Please read them carefully and heed all warnings.

Installation

1. Do not point the projection beam toward other people or reflective objects.
2. Consult your distributor for information about transporting and installing the projector. Do not attempt to transport and install the projector yourself. The projector must be installed by qualified technicians in order to ensure proper operation and reduce the risk of bodily injury.
3. Place the projector on a flat, level surface in a dry area away from dust and moisture. Do not put the projector on its side when the Laser is on. Doing so may cause damage to the projector.
4. Do not place the projector in direct sunlight, near heaters or heat radiating appliances.

5. Exposure to direct sunlight, smoke or steam could harm internal components.
6. Handle your projector carefully. Dropping or jarring your projector could damage internal components.
7. To carry the projector, a minimum of six persons are required. Be sure to firmly grip the front and back handles, then move the projector.
8. Do not hold the lens part with your hand. Otherwise the projector may tumble or drop, causing personal injury.
9. Do not place heavy objects on top of the projector.
10. Turn off the projector, and disconnect the power cable before moving the projector.
For C2 connection, turn off the projector, shut down the AC power to the projector and the light using a circuitbreaker. Disconnect the cables between devices and the light before moving the projector.
11. Do not install and store the projector in the below circumstances. Failure to do so may cause of malfunction.
 - In powerful magnetic fields
 - In corrosive gas environment
 - Outdoors
12. If you need special installation work such as mounting on the ceiling or suspending from the ceiling using eye bolts:
 - Do not attempt to install the projector yourself.
 - The projector must be installed by qualified technicians in order to ensure proper operation and reduce the risk of bodily injury.
 - In addition, the ceiling must be strong enough to support the projector and the installation must be in accordance with any local building codes.
 - If you hang the projector from the high place such as the ceiling, use fall prevention wires (commercially available) to secure the lens unit in place. Failing to do so may result in the lens unit being loosened, causing it to fall.
 - Please consult your distributor for more information.

WARNING



Do not do it

1. Do not use the projector with the supplied lens cap or equivalent while the projector is operating. This may cause the lens cap to heat up and deform or melt.
2. Do not place any objects, which are easily affected by heat, in front of the projector lens. Doing so could lead to the object melting from the heat that is emitted from the light output.



It is possible to vertically set up this device at 360 degrees. Do not use the projector with it leaning to the left and right. This may result in a malfunction, however, portrait installation is possible. Please read the warnings concerning portrait orientation before setting the projector in portrait orientation.

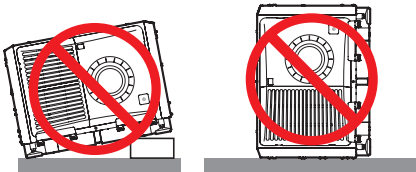

Power Supply

1. Consult your distributor for installing the power cable to the projector. **DO NOT** install the power cable by yourself. Doing so may cause a fire or electric shock. The projector is so designed that it operates with the power supply voltage described below.
For C1 connection
(When the AC power to the projector power supply and the light power supply is provided by a single cable)
 - AC 200V-240V single phase 50/60HzFor C2 connection
(When the AC power to the projector power supply and the light power supply is provided by separate cables)
 - AC 200V-240V single phase 50/60Hz (projector power supply)
 - AC 200V-240V single phase 50/60Hz (light power supply)Ensure that your power supply fits this requirement before attempting to use your projector.
2. The power cable is not included with the projector. Ask your distributor for the power cable to select and purchase. Use a power cable that meets the standards and power supply voltage of the country where you are using the projector.
Refer to “2. Connecting the Power Cable” (→ page 17) for details on connecting the power cable.

3. Handle the power cable carefully. A damaged or frayed power cable can cause electric shock or fire.
 - Do not bend or tug the power cable excessively.
 - Do not place the power cable under the projector, or any heavy object.
 - Do not cover the power cable with other soft materials such as rugs.
 - Do not heat the power cable.
4. Placing the power cable and the signal cable closely to each other can cause beat noise. If this happens, keep the two separated so that beat noise is not generated.
Beat noise is corruption of the picture often seen as a rolling band moving through the image.
5. Do not touch the projector during a thunder storm. Doing so can cause electrical shock or fire.
6. When installed on the ceiling, install the breaker in a location that is easy to reach by hand.

CAUTION

This equipment is designed to be used in the condition of the power cable connected to earth. If the power cable is not connected to the earth, it may cause electric shock. Please make sure the power cable is earthed properly.

Fire and Shock Precautions

1. Ensure that there is sufficient ventilation and that vents are unobstructed to prevent potentially dangerous concentrations of ozone and the build-up of heat inside your projector. Allow at least 23.6 inches (60 cm) of space between your projector and a wall. In particular, clear a space of 27.6 inches (70 cm) or more in front of the air outlet on the rear surface and 11.8 inches (30 cm) or more on the upper part of the projector body. (→ page xi)
2. Prevent foreign objects such as paper clips and bits of paper from falling into your projector. Do not attempt to retrieve any objects that might fall into your projector. Do not insert any metal objects such as a wire or screwdriver into your projector. If something should fall into your projector, shut down the AC power to the projector immediately and have the object removed by a qualified service person.
For C2 connection, turn off the projector, shut down the AC power to the projector and the light using a circuit breaker, and contact your dealer/distributor.
3. Turn off the projector, shut down AC power by using a circuit breaker and contact qualified service personnel under the following conditions. For C2 connection, turn off the projector, shut down the AC power to the projector and the light using a circuit breaker, and contact your dealer/distributor for a repair.
 - When the power cable or plug is damaged or frayed.
 - If liquid has been spilled into the projector, or if it has been exposed to rain or water.
 - If the projector does not operate normally when you follow the instructions described in this user's manual.
 - If the projector has been dropped or the cabinet has been damaged.
 - If the projector exhibits a distinct change in performance, indicating a need for service.
4. When using a LAN cable:
For safety, do not connect to the connector for peripheral device wiring that might have excessive Voltage.
5. Make sure to mount the power cable stopper before attempting to use your projector. Refer to page 18 about the power cable stopper.

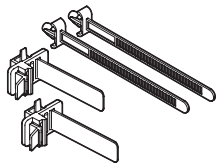

Cleaning

1. Shut down AC power by using a circuit breaker before cleaning.
For C2 connection, turn off the projector, shut down the AC power to the projector and the light using a circuit breaker.
2. Clean the cabinet periodically with a cloth. If heavily soiled, use a mild detergent. Never use strong detergents or solvents such as alcohol or thinner.
3. Use a blower or lens paper to clean the lens, and be careful not to scratch or mar the lens.
4. Do not handle the projector and the power cable with wet hands. Doing so can cause electrical shock or fire.
5. Do not use a spray containing flammable gas to remove dust attached to the lens and cabinet. Doing so may result in fires.

 **CAUTION**

 **Do not do it**

1. Do not shut down AC power to the projector under the following conditions. Doing so can damage the projector.
 - While projecting images
 - While cooling after the power is turned off.
2. Do not turn off the AC power for 90 seconds after the Laser is turned on and while the POWER indicator is blinking green. Doing so could cause premature Laser failure.
3. Keep hands away from the lens mounting portion while the lens shift is in operation. Failure to do so could result in fingers being pinched between the cabinet and lens cover.
4. When main body is damaged, cooling fluids may come out of internal part. **DO NOT** touch and drink the cooling fluid.
When the cooling fluids are swallowed or contacted with your eyes, please consult with doctors immediately.

Caution on Carrying the Projector/ Handling the Optional Lens

When installing / removing a lens, shut down the AC power to the projector.

When shipping the projector with the lens, remove the lens before shipping the projector. Always attach the dust cap to the lens whenever it is not mounted on the projector. The lens and the lens shift mechanism may encounter damage caused by improper handling during transportation.

Cable information

CAUTION

For HDMI, DisplayPort, BNC, LAN, RS232C, 3D, and GP I/O, please use a shielded cable.

Use of other cables may cause interference with radio and television reception.

Remote Control Precautions

- Handle the remote control carefully.
- If the remote control gets wet, wipe it dry immediately.
- Avoid excessive heat and humidity.
- Do not short, heat, or take apart batteries.
- Do not throw batteries into fire.
- If you will not be using the remote control for a long time, remove the batteries.
- Ensure that you have the batteries' polarity (+/-) aligned correctly.
- Do not use new and old batteries together, or use different types of batteries together.
- Dispose of used batteries according to your local regulations.

Light Module

1. A light module containing multiple laser diodes is included in the product as the light source.
2. These laser diodes are sealed in the light module. No maintenance or service is required for the performance of the light module.
3. End user is not allowed to replace the light module.
4. Contact qualified distributor for light module replacement and further information.

Disposing of your used product



EU-wide legislation as implemented in each Member State requires that used electrical and electronic products carrying the mark (left) must be disposed of separately from normal household waste.

This includes projectors and their electrical accessories. When you dispose of such products, please follow the guidance of your local authority and/or ask the shop where you purchased the product.

After collecting the used products, they are reused and recycled in a proper way. This effort will help us reduce the wastes as well as the negative impact to the human health and the environment at the minimum level.

The mark on the electrical and electronic products only applies to the current European Union Member States.



For EU: The crossed-out wheeled bin implies that used batteries should not be put to the general household waste! There is a separate collection system for used batteries, to allow proper treatment and recycling in accordance with legislation.

According to EU directive 2006/66/EC, the battery can't be disposed improperly. The battery shall be separated to collect by local service.

Label Information

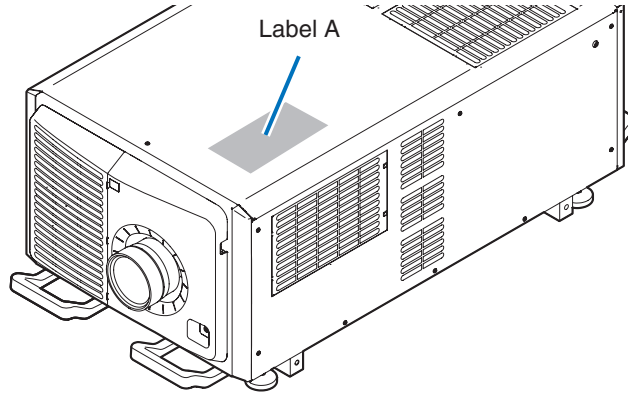

Label A: Risk Group /Lamp Safety Label

RISK GROUP 3
WARNING
 DO NOT LOOK INTO THE BEAM.
 NO DIRECT EYE EXPOSURE TO THE BEAM IS PERMITTED.
 HAZARD DISTANCE: REFER TO THE MANUAL.

GROUPE DE RISQUE 3
AVERTISSEMENT
 NE PAS REGARDER DIRECTEMENT DANS LE FAISCEAU.
 L'EXPOSITION DIRECTE DES YEUX AU FAISCEAU EST INTERDITE.
 DISTANCE À RISQUE: SE REPORTER AU MANUEL.

RISIKOGRUPPE 3
WARNUNG
 SCHAUEN SIE NICHT IN DEN STRAHL.
 DIREKTER AUGENKONTAKT MIT DEM STRAHL IST NICHT ERLAUBT.
 SICHERHEITSABSTAND: SIEHE HANDBUCH.

ГРУППА РИСКА 3
ПРЕДУПРЕЖДЕНИЕ
 НЕ СМОТРИТЕ НА ЛУЧ.
 ЗАПРЕЩАЕТСЯ ЛЮБОЕ ПРЯМОЕ ВОЗДЕЙСТВИЕ ЛУЧА НА ГЛАЗА.
 ОПАСНОЕ РАСТОЯНИЕ: СМ. РУКОВОДСТВО ПО ЭКСПЛУАТАЦИИ.

リスクグループ 3
警告
 ビームを見ないこと。
 目へのビームの直接曝露を禁止する。
 障害距離:取扱説明書を参照。

위험 그룹 3
경고
 빔을 눈으로 보지 마십시오.
 빔을 직접 눈에 노출하는 것은 허용되지 않습니다.
 위험 거리: 설명서를 참조하십시오.

风险组别 3
警告
 请勿注视光束。
 不允许将眼睛暴露于光束中。
 有害距离: 请参阅手册。
 IEC/EN 62471-5:2015

FOR NORTH AMERICA
RISK GROUP 3
WARNING
 HAZARDOUS OPTICAL RADIATION EMITTED FROM THIS PRODUCT.
 DO NOT LOOK AT OPERATING LIGHT SOURCE.
 EYE INJURY MAY RESULT.
 HAZARD DISTANCE: REFER TO THE MANUAL.
 NO DIRECT EXPOSURE TO BEAM SHALL BE PERMITTED.
 NOT FOR HOUSEHOLD USE.

GROUPE DE RISQUE 3
AVERTISSEMENT
 RADIATIONS OPTIQUES DANGEREUSES EMISES PAR CE PRODUIT.
 NE REGARDER PAS DIRECTEMENT LA SOURCE LUMINEUSE.
 CELA POURRAIT ENTRAÎNER DES BLESSURES AUX YEUX.
 DISTANCE À RISQUE: SE REPORTER AU MANUEL.
 L'EXPOSITION DIRECTE AU RAYON DOIT ÊTRE AUTORISÉE.
 NE CONVIENT PAS À UN USAGE DOMESTIQUE.

IEC/TR 62471-2:2009
 IEC/EN 62471:2006

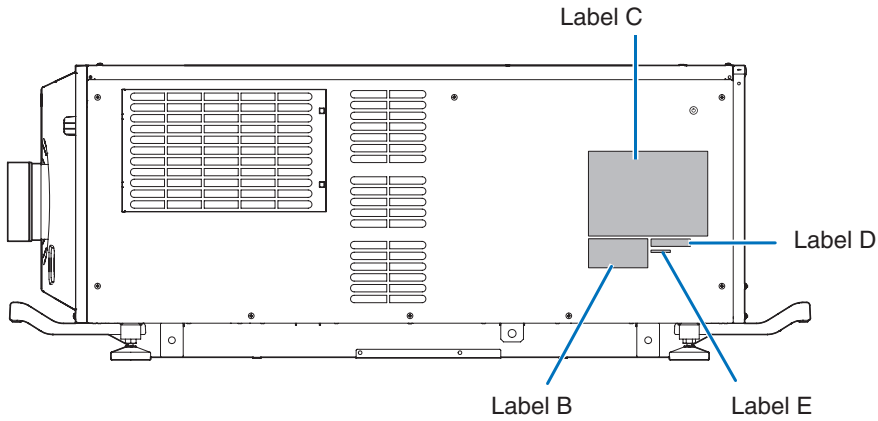

Label B
Laser Explanatory Label



Label C
PH3501QL

NEC MODEL No. NP-PH3501QL C1: 200-240V ~ 50/60Hz 30.0A
 C2: 200-240V ~ 50/60Hz 4.9A for PJ POWER
 200-240V ~ 50/60Hz 25.1A for LIGHT POWER

CE

NEC Display Solutions, Ltd. 4-28, Mita 1-chome, Minato-ku, Tokyo, Japan
 Contact address for EMEA NEC Display Solutions Europe GmbH Landshuter Allee 12-14 80637 Munich, Germany
 Tegangan dan Frekuensi: C1: 200-240V ~ 50/60Hz C2: 200-240V ~ 50/60Hz(PROYEKTOR CATU DAYA) 200-240V ~ 50/60Hz(CAHAYA CATU DAYA) Produksi China

MADE IN CHINA THIS CABINET IS CONSTRUCTED OF METAL(AL)

	警告 高压注意
	サービスマン以外の方は外装パネルを外さないでください。内部には高電圧部分が数多くあり、カーさわると危険です。

使用上の注意
 イ. 通風孔をふさがないでください。内部温度の上昇を招き故障の原因になります。
 ロ. 温度の高い場所や湿気の多い場所での使用はさけてください。

CAUTION: TO PREVENT ELECTRIC SHOCK, DO NOT OPEN TOP COVER. NO USER-SERVICEABLE PARTS INSIDE.
ATTENTION: AFIN DE PREVENIR UN CHOC ELECTRIQUE NE PAS ENLEVER LE COUVERCLE S'ADRESSER A UN REPARATEUR COMPETENT.
ВНИМАНИЕ: ВО ИЗБЕЖАНИЕ УДАРА ЭЛЕКТРИЧЕСКИМ ТОКОМ НЕ ОТКРЫВАЙТЕ ВЕРХНЮЮ КРЫШКУ. ВНУТРИ НЕТ ДЕТАЛЕЙ, ОБСЛУЖИВАЕМЫХ ПОЛЬЗОВАТЕЛЕМ.

주의: 전기충격 방지를 위해 캐비닛을 열지 마십시오. 내부에는 사용자를 위한 서비스가능 부품이 들어있지 않습니다.
ACHTUNG: Zur Vermeidung eines elektrischen Schlages, öffnen Sie das Gehäuse nicht selbst. In diesem Gerät sind keine Teile enthalten, die vom Nutzer gewartet werden können.

この装置は、クラス A 機器です。この装置を住宅環境で使用すると電波妨害を引き起こすことがあります。この場合には使用者が適切な対策を講ずるよう要求されることがあります。 VCCI-A

THIS DEVICE COMPLIES WITH PART 15 OF THE FCC RULES, OPERATION IS SUBJECT TO THE FOLLOWING TWO CONDITIONS:
 (1) THIS DEVICE MAY NOT CAUSE HARMFUL INTERFERENCE, AND
 (2) THIS DEVICE MUST ACCEPT ANY INTERFERENCE RECEIVED, INCLUDING INTERFERENCE THAT MAY CAUSE UNDESIRED OPERATION.
 CAN ICES-3(A)/NMB-3(A)

Label C
PH2601QL

NEC MODEL No. NP-PH2601QL C1: 200-240V ~ 50/60Hz 30.0A
 C2: 200-240V ~ 50/60Hz 4.9A for PJ POWER
 200-240V ~ 50/60Hz 25.1A for LIGHT POWER

CE 

NEC Display Solutions Ltd. Contact address for EMEA Tagangan dan Frekuensi:
 4-28, Mita 1-chome, Minato-ku, Tokyo, Japan NEC Display Solutions Europe GmbH C1: 200-240V ~ 50/60Hz
 Landshuter Allee 12-14 C2: 200-240V ~ 50/60Hz (PROYEKTOR CATU DAYA)
 80637 Munich, Germany 200-240V ~ 50/60Hz (CAHAYA CATU DAYA)
 MADE IN CHINA Produksi China

THIS CABINET IS CONSTRUCTED OF METAL(AL)

	警告 高圧注意
	サービスマン以外の方は外装パネルを外さないでください。内部には高電圧部分が多くあり、万一さわると危険です。

使用上の注意
 イ、通風孔をふさがないでください。内部温度の上昇を招き故障の原因になります。
 ロ、温度の高い場所や湿気の多い場所での使用はさけてください。

CAUTION: TO PREVENT ELECTRIC SHOCK, DO NOT OPEN TOP COVER. NO USER-SERVICEABLE PARTS INSIDE.
ATTENTION: AFIN DE PREVENIR UN CHOC ELECTRIQUE NE PAS ENLEVER LE COUVERCLE S'ADRESSER A UN REPARATEUR COMPETENT.
ВНИМАНИЕ: ВО ИЗБЕЖАНИЕ УДАРА ЭЛЕКТРИЧЕСКИМ ТОКОМ НЕ ОТКРЫВАЙТЕ ВЕРХНЮЮ КРЫШКУ. ВНУТРИ НЕТ ДЕТАЛЕЙ, ОБСЛУЖИВАЕМЫХ ПОЛЬЗОВАТЕЛЕМ.
주의: 전기충격 방지를 위해 캐비닛을 열지 마십시오. 내부에는 사용자를 위한 서비스가능 부품이 들어있지 않습니다.
ACHTUNG: Zur Vermeidung eines elektrischen Schlages, öffnen Sie das Gehäuse nicht selbst. In diesem Gerät sind keine Teile enthalten, die vom Nutzer gewartet werden können.

この装置は、クラスA機器です。この装置を住宅環境で使用すると電波妨害を引き起こすことがあります。この場合には使用者が適切な対策を講ずるよう要求されることがあります。 VCCI-A

THIS DEVICE COMPLIES WITH PART 15 OF THE FCC RULES. OPERATION IS SUBJECT TO THE FOLLOWING TWO CONDITIONS:
 (1) THIS DEVICE MAY NOT CAUSE HARMFUL INTERFERENCE, AND
 (2) THIS DEVICE MUST ACCEPT ANY INTERFERENCE RECEIVED, INCLUDING INTERFERENCE THAT MAY CAUSE UNDESIRE OPERATION. CAN ICES-3(A)/NMB-3(A)

Label D



MODEL NO. NP-XXXXXXX XXXXXXXX

Label E

M/F Date : YYYY. MM. DD

Radiation Range of Emitted Light by the Projector (HD: Hazard Distance)

- The below table describes the radiation range of emitted light by the projector that is classified as Risk Group 3 (RG3) of IEC62471-5 First edition 2015.
- The below table describes the radiation range of emitted light by the projector that is classified as Risk Group 3 (RG3) of IEC62471:2006 (for USA).
- Please keep within bounds for installing the projector.
 Install a barrier for preventing human eyes from entering the RG3 area. For the barrier installation position, keep horizontal safety zone over 1.5m from the RG3 area. In case to install the projector over head, keep over 3m distance at least between the floor surface and the RG3 area.
 Operators shall control access to the beam within the hazard distance or install the product at the height that will prevent exposures of spectators' eyes within the hazard distance.

(IEC62471-5 First edition 2015)

Lens	RG3 HD(m)	Screen size(m)	
		H	V
L2K-10F1	4.1	4.51	2.38
L4K-11ZM	Wide	4.6	2.15
	Tele	7.1	2.18
L4K-15ZM	Wide	6.2	2.25
	Tele	9.1	2.29
L4K-20ZM	Wide	8.2	2.18
	Tele	14.0	2.17
L2K-30ZM	Wide	11.0	2.15
	Tele	16.0	2.16
L2K-43ZM1	Wide	16.0	2.16
	Tele	22.0	2.15
L2K-55ZM1	Wide	21.0	2.21
	Tele	32.0	2.19

(IEC62471:2006 (for USA))

Lens	RG3 HD(m)	Screen size(m)		EHv
		H	V	
L2K-10F1	4.1	4.51	2.38	10
L4K-11ZM	Wide	4.6	2.15	11
	Tele	7.1	2.18	14
L4K-15ZM	Wide	6.2	2.25	12
	Tele	9.1	2.29	17
L4K-20ZM	Wide	8.2	2.18	16
	Tele	14.0	2.17	17
L2K-30ZM	Wide	11.0	2.15	20
	Tele	16.0	2.16	22
L2K-43ZM1	Wide	16.0	2.16	22
	Tele	22.0	2.15	22
L2K-55ZM1	Wide	21.0	2.21	24
	Tele	32.0	2.19	27

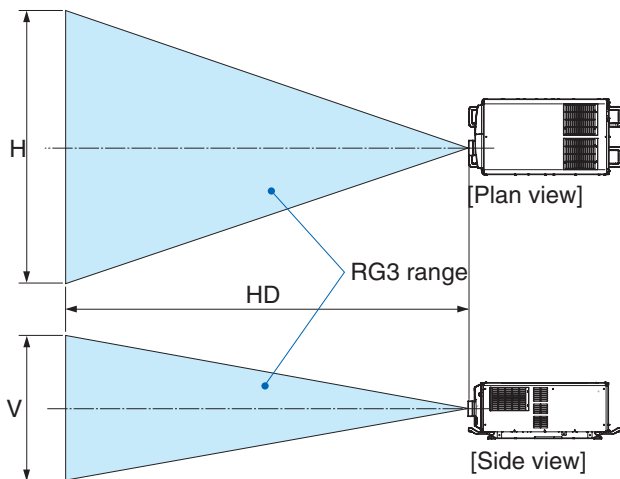

* If lens shift is utilized, please consider the shift of projected image according to the volume of lens shift. (→ page 147)



Please heed all precaution for safety.

To install the projector

- For planning the layout of the projector, make sure to take safety measures instructed on the installation manual.
- In order to refuse danger, install either a wall outlet within easy reach for pulling out the power plug in emergency or a device as a breaker to shut down the power supply to the projector.
- Take safety measures preventing human eyes from entering the RG3 area.
- Considering the installation place, select an appropriate lens and secure safety zone that is determined for each lens. For operation on the powered projector as light adjustment, make sure appropriate safety measures have been taken.
- Check the validity of taken security measures if appropriate safety zone based on the installed lens is secured. Periodically check the validity and keep these results.
- Educate the administrator of the projector (operators) about safety before starting to operate the projector.

To use the projector

- Instruct the administrator of the projector (operators) to perform inspections before powering on the projector. (Including the safety check against emitted light by the projector)
- Instruct the administrator of the projector (operators) to be in circumstances able to control the projector whenever the projector is powered on for an emergency.
- Instruct the administrator of the projector (operators) to keep the installation manual, user's manual and inspection records to a place where they can take these documents out easily.
- Instruct them to clarify if the projector is conformed to standards of each country and region.

Clearance for Installing the Projector

Allow ample clearance between the projector and its surroundings as shown below. The high temperature exhaust coming out of the device may be sucked into the device again. Avoid installing the projector in a place where air movement from the HVAC is directed at the projector. Heated air from the HVAC can be taken in by the projector's intake vent. If this happens, the temperature inside the projector will rise too high causing the over-temperature protector to automatically turn off the projectors power.

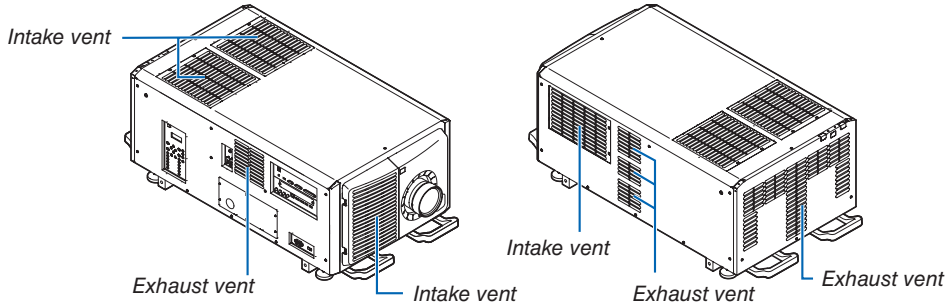

Example 1 - If there are walls on both sides of the projector.

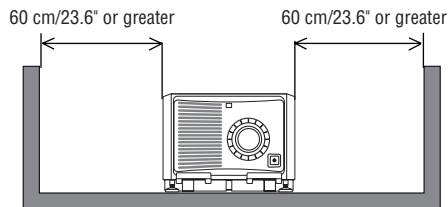

NOTE:

- The drawing shows the proper clearance required for the front, back, and top of the projector.
- The above drawing can also be applied to the required clearance between intake vent and the floor for the portrait projection.
- See page 154 for an installation example on portrait projection.

Example 2 - If there is a wall behind the projector.

(1) For floor installation:

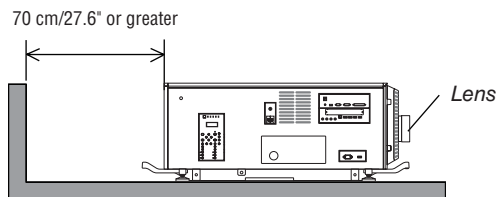

NOTE:

- The drawing shows the proper clearance required for the right, left, and top of the projector.

(2) For ceiling mounting:

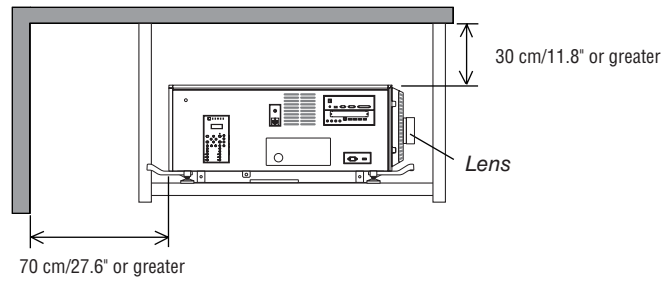

NOTE:

- *The drawing shows the proper clearance required for the front, right, left, and bottom of the projector.*

Health precautions to users viewing 3D images

Before viewing, be sure to read health care precautions that may be found in the user's manual included with your 3D eyeglasses or your 3D compatible content such as Blu-ray Discs, video games, computer's video files and the like. To avoid any adverse symptoms, heed the following:

- Do not use 3D eyeglasses for viewing any material other than 3D images.
- Allow a distance of 2 m/7 feet or greater between the screen and a user. Viewing 3D images from too close a distance can strain your eyes.
- Avoid viewing 3D images for a prolonged period of time. Take a break of 15 minutes or longer after every hour of viewing.
- If you or any member of your family has a history of light-sensitive seizures, consult a doctor before viewing 3D images.
- While viewing 3D images, if you get sick such as nausea, dizziness, queasiness, headache, eyestrain, blurry vision, convulsions, and numbness, stop viewing them. If symptoms still persist, consult a doctor.
- View 3D images from the front of the screen. Viewing from an angle may cause fatigue or eyestrain.

About Copyright of original projected pictures:

Please note that using this projector for the purpose of commercial gain or the attraction of public attention in a venue such as a coffee shop or hotel and employing compression or expansion of the screen image with the following functions may raise concern about the infringement of copyrights which are protected by copyright law.

[ASPECT RATIO], Magnifying feature and other similar features.

Table of Contents

Important Information	i
1. Introduction	1
❶ What's in the Box?	1
❷ Introduction to the Projector.....	3
❸ Part Names of the Projector	6
❹ Part Names of the Remote Control.....	12
2. Projecting an Image (Basic Operation)	16
❶ Flow of Projecting an Image	16
❷ Connecting the Power Cable	17
❸ Connecting Your Computer.....	20
❹ Turning on the Projector.....	21
❺ Selecting a Source	25
❻ Adjusting the Picture Size and Position	28
❼ Turning off the Projector.....	34
3. Convenient Features	36
❶ Stopping projection.....	36
❷ Turning off the light source.....	36
❸ Locking the projector so it cannot be operated.....	36
❹ Muting the Image (AV Mute).....	37
❺ Turning Off the On-Screen Menu (On-Screen Mute)	37
❻ Shift the On-Screen Menu displaying position.....	38
❼ Freezing a Picture.....	39
❽ Magnifying a Picture	40
❾ Adjusting the brightness [LIGHT MODE]	41
❿ Correcting Horizontal and Vertical Keystone Distortion [CORNERSTONE].....	42
⓫ Preventing the Unauthorized Use of the Projector [SECURITY].....	45
⓬ Projecting 3D videos.....	48
⓭ Controlling the Projector by Using an HTTP Browser.....	50
⓮ Storing Changes for Lens Shift, Zoom, and Focus [LENS MEMORY].....	51
4. Multi-Screen Projection	57
❶ Things that can be done using multi-screen projection	57
❷ Using a single projector to project two or four types of videos at the same time [PICTURE BY PICTURE].....	58
❸ Line up multiple projectors to display a high resolution image in a larger screen [TILING]	60
❹ Adjust boundaries of a projected image [EDGE BLENDING].....	64

5. Using On-Screen Menu	70
1 Using the Menus.....	70
2 Menu Elements.....	71
3 List of Menu Items	72
4 Menu Descriptions & Functions [INPUT]	78
5 Menu Descriptions & Functions [ADJUST]	82
6 Menu Descriptions & Functions [DISPLAY]	98
7 Menu Descriptions & Functions [SETUP]	108
8 Menu Descriptions & Functions [INFO.]	132
6. Connecting to Other Equipment	136
7. Maintenance	138
1 Cleaning the Cabinet	138
2 Cleaning the Lens.....	138
3 Cleaning the Air Filters.....	139
8. Appendix	143
1 Throw distance and screen size	143
2 Compatible Input Signal List.....	149
3 Specifications	151
4 Outline Drawing	153
5 Portrait projection (vertical orientation).....	154
6 Pin assignments and signal names of main terminals.....	155
7 About the ASCII Control Command	160
8 Changing the Background Logo (Virtual Remote Tool).....	162
9 Troubleshooting	163
10 Indicator Messages	165
11 Troubleshooting Check List.....	168
12 GPL/LGPL Software Licenses.....	170
13 REGISTER YOUR PROJECTOR! (for residents in the United States, Canada, and Mexico)	171

1. Introduction

① What's in the Box?

Check the content of the accessories.

- Projector
- Lens hole cap

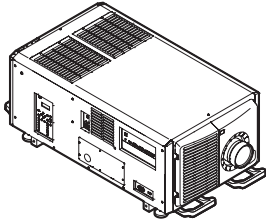

- Service keys × 2

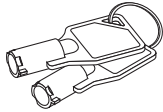

- Administrator key × 2

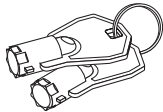

- Controls/Indicator Panel display label

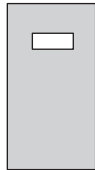

- Plate Inlet Ø35

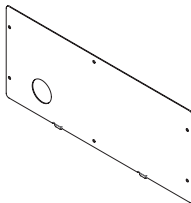

- Power cable stopper

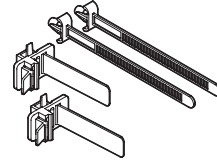

- Important Information

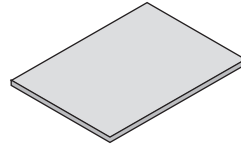

- Lens holder

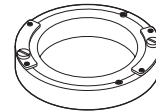

- Gear box cover
- Screw × 2

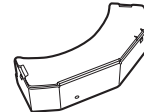

- Warranty
 - For North America
 - For Japan

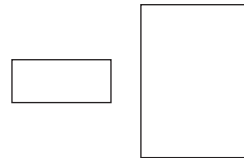

For customers in Europe:
You will find our current valid Guarantee Policy on
our Web Site:
<https://www.nec-display-solutions.com>

LV Kit (NP-LV01BD)

- LV unit
- Remote control
- AA alkaline batteries (× 2)

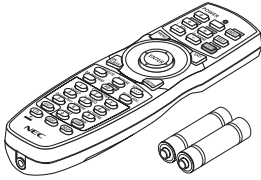

- NEC Projector CD-ROM
User's Manual (PDF)



- Important Information (NP-LV01BD)
- Quick Setup Guide

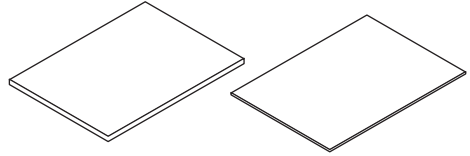

About the LV kit

- This unit cannot be used with the projector unit alone. Be sure to use it in combination with the LV kit (NP-LV01BD).
- Have your distributor install the LV unit.
- Descriptions and illustrations are given in this manual with the LV unit installed.

About the control/indicator panel display label

- Attach the label to the control/indicator panel before using the projector.
- Have your distributor attach the control/indicator panel display label.
- Descriptions and illustrations are given in this manual with the label affixed.

② Introduction to the Projector

This section introduces you to your new projector and describes the features and controls.

General

- **Three-chips DLP projector with high resolution and high brightness**

Model name	Brightness	Resolution	Aspect Ratio
PH3501QL	35,000 lm / 40,000 lm (center)	4096 × 2160 (4K)	17:9
PH2601QL	26,000 lm / 30,000 lm (center)	4096 × 2160 (4K)	17:9

- **Superior dust prevention abilities**

The projector utilizes a circular cooling system when cooling the optical components. It cycles cold air to replace the warm air inside the interior of the airtight case so open air does not touch the optical components. This protects against the device getting dirty with dust and dirt, as well as maintains brightness.

* However, it cannot perfectly insulate against dust.

- **Running cost reduction by using a metal filter**

With regular cleaning, the filter can be repeatedly used without replacement.

On top of reducing running costs, we have implemented this eco-friendly feature so there is no need to dispose of used filters.

- **4K element user logo images can be registered**

4K element images can be registered and output as background logos in real 4K resolution.

Light source • Brightness

- **Employs a long life laser light source**

The projector employs a newly developed laser light source offering excellent reliability and redundancy. Since the laser light source has a long life (approx. 20,000 hours), this delivers low cost operation by removing the need for maintenance such as replacing and adjusting the light module over extended periods of time. Furthermore, it reduces the risk of the light source suddenly shutting off and leaving a black screen.

- **Brightness can be adjusted within a wide range**

Unlike with ordinary light sources, the brightness can be adjusted from 30* to 100% in 1% increments.

* PH2601QL: 40%

- **[CONSTANT BRIGHTNESS] mode**

Brightness normally decreases with use, but by selecting [CONSTANT BRIGHTNESS] mode, sensors inside the projector detect and automatically adjust the output, thereby maintaining constant brightness throughout the life of the light module.

However, if brightness output is set at the maximum, brightness will decrease with use.

Installation

- **Wide range of optional lenses selectable according to the place of installation**

This projector supports 7 types of optional lenses, providing a selection of lenses adapted to a variety of places of installation and projection methods. No lens is mounted at shipping from the factory. Contact your distributor for purchasing and replacing these optional lenses sold separately.

- **Tilt-free, portrait projection**

This projector can be set to any angle within a vertical 360° range.

It can also rotate the picture 90° into portrait orientation, however, it cannot be installed with right or left slant besides the portrait projection.

- **Ceiling installation is easy**

This unit can be suspended using eye bolts. It is easy to install because the structure not only allows it to be moved but also permanently mounted by suspending it from a ceiling.

When installing using eye bolts, have your distributor install the unit.

Videos

- **High quality pictures using Cinema Quality Picture technology**

The device displays high-resolution pictures with its rich gradation expression capability and by improving the contrast in the picture boundary area using the development technology for digital cinema projectors and the unique NEC video processor for image processing.



- **A variety of input terminals such as HDMI, DisplayPort, HDBaseT, SDI, etc.**

Use this unit in combination with the LV kit sold separately. The LV unit is equipped with HDMI (1/2), DisplayPort (1/2), HDBaseT, SDI (1/2/3/4) input terminals. Moreover, You can install optional boards (sold separately) to SLOT.

The projector's HDMI input terminals and DisplayPort input terminals support HDCP.

HDBaseT, promoted and advanced by the HDBaseT Alliance, is a connection standard for home appliances.

- **Displaying two or four images at the same time (PICTURE BY PICTURE)**

With this single projector you can project two or four images at the same time.

When projecting two images, you can adjust its position on the screen. The projector also supports the portrait projection.

- **Multi-screen projection using multiple projectors**

You can line up multiple projectors to display a high resolution image in a larger screen.

Furthermore, the boundaries of the screens are smoothed using an edge blending function.

- **Color calibration function according to the installation environment**

This function reflects a variety of conditions specific to the site such as the type of screen, the color of the surrounding wall (interior), lighting, etc., to reproduce the intended colors faithfully.

Network

- **Supports wired LAN**

Equips the LAN and HDBaseT (RJ-45) ports. Utilizing a wired LAN connected with these ports, it enables to control the projector by a computer.

- **Convenient utility software (User Supportware) provided as standard**

This projector supports our utility software (NaViSet Administrator 2, Virtual Remote Tool, etc.).

NaViSet Administrator 2 helps you control the projector by a computer via wired LAN connection.

Virtual Remote Tool helps you perform operations by a virtual remote control such as projector's power on or off and signal selection via wired LAN connection. Moreover, it has function to send an image to the projector and register it as the logo data.

Please visit our web site for downloading each software.

URL: <https://www.nec-display.com/dl/en/index.html>

About this user's manual

The fastest way to get started is to take your time and do everything right the first time. Take a few minutes now to review the user's manual. This may save you time later on. At the beginning of each section of the manual you'll find an overview. If the section doesn't apply, you can skip it.

③ Part Names of the Projector

Front of the projector

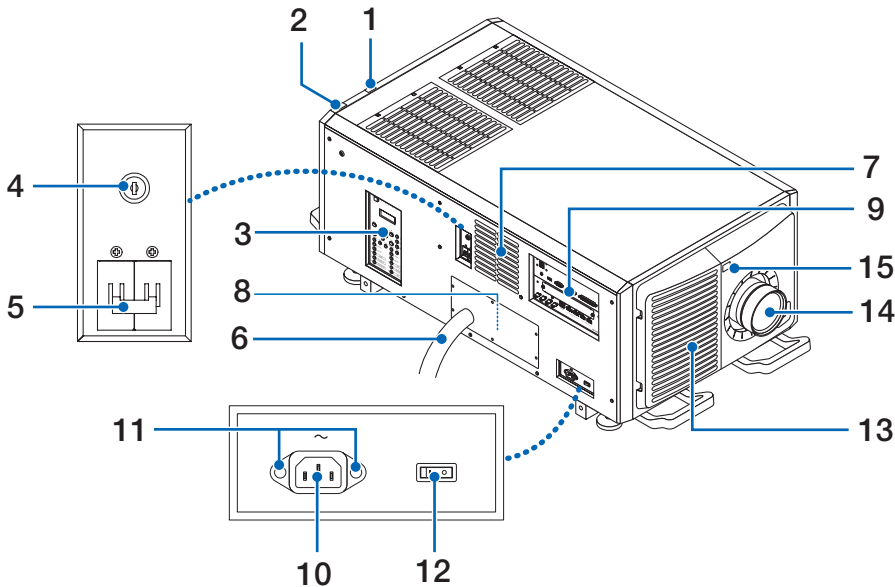

1. Light status indicator

Displays the status of the light source. The indicators turn on when the light source is on and turn off when the light source is off. (→ page 166)

2. System status indicator

Indicates the status of the projector. When the projector is operating normally, these light/blink in green or orange. When an error occurs, they light/blink in red. When an error occurs, check the contents of the display on the LCD screen. (→ page 166)

3. Controls/Indicator panel

- The power supply of the projector and the signal of the picture to project can be turned ON/OFF and switched here.
 - Indicates the status of the unit e.g. Power ON / Standby etc.
- (→ page 11)

4. Administrator switch

The projector can be operated normally by inserting the administrator key vertically and turning it to the horizontal direction.

At this time, the administrator key cannot be removed. The projector will not function unless the administrator key is inserted.

5. Light power switch

While AC power is being supplied, set the projector power switch and light power switch to ON position, then your projector will enter a standby state.

6. AC power cable

This is the cable that supplies AC power to the projector head. Contact your dealer/distributor for connecting the power cable or AC power cable.

7. Air outlet

The air outlet to exhaust heat inside the projector. Do not cover.

8. Remote interlock connector (inside side of projector)

This port is for safely using this device. It is used to externally control the projector. Consult with your dealer/distributor about using this.

9. Connection terminals

Various image signal cable are to be connected here. (→ page 10)

10. AC input

Connects to the AC power cable. The AC power cable is not an accessory. Consult with your dealer/distributor about the AC power cable.

11. Mounting hole for power supply cable stopper

Attach the enclosed power cable stopper to prevent the connector of the power cable from falling out.

12. Projector power switch

While AC power is being supplied, set the projector power switch and light power switch to ON position, then your projector will enter a standby state.

13. Air inlet / Air filter

The air inlet for cooling inside the projector. Do not cover.

An air filter is attached over the air inlet to prevent dust. Refer to “**3** Cleaning the Air Filters” (→ page 139) on how to clean the air filter.

14. Lens (optional)

Images are projected from the lens. Request your dealer/distributor to install or replace the lens.

15. Remote Sensor (located on the front and the rear)

(→ page 14)

NOTE:

- Do not cover the air inlets and outlet while the projector is in operation. Insufficient ventilation leads to a rise of the internal temperature and may cause a fire or malfunction.
-

Rear of the projector

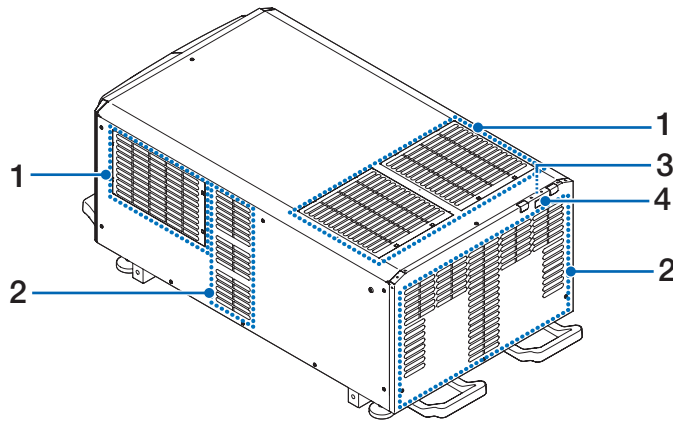

1. Air inlet / Air filter

The air inlet for cooling inside the projector. Do not cover.

Two filters are attached over the air inlet to prevent dust. Refer to “**3** Cleaning the Air Filters” (→ page 139) on how to clean the air filters.

2. Air outlet

The air outlet to exhaust heat inside the projector. Do not cover.

3. Buzzer (inside rear of projector)

The buzzer rings when the power is turned on or an error has occurred.

4. Remote Sensor

NOTE:

- *Do not cover the air inlets and outlet while the projector is in operation. Insufficient ventilation leads to a rise of the internal temperature and may cause a fire or malfunction.*
-

Bottom of the projector

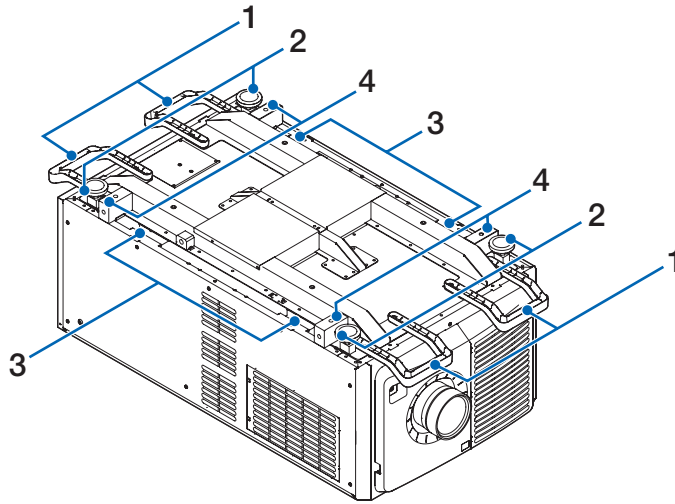

1. Handle (4 locations)

Handles for moving the projector.

2. Level adjusters (in 4 positions)

In the ordinary installation, you can adjust the projector inclination at 4 positions.

3. Handle (4 locations)

Handles for moving the projector.

4. Eyebolt mounting holes (4 locations)

These are used to suspend the projector for movement and installation purposes.
When installing using eye bolts, have your distributor install the unit.

Connection terminals

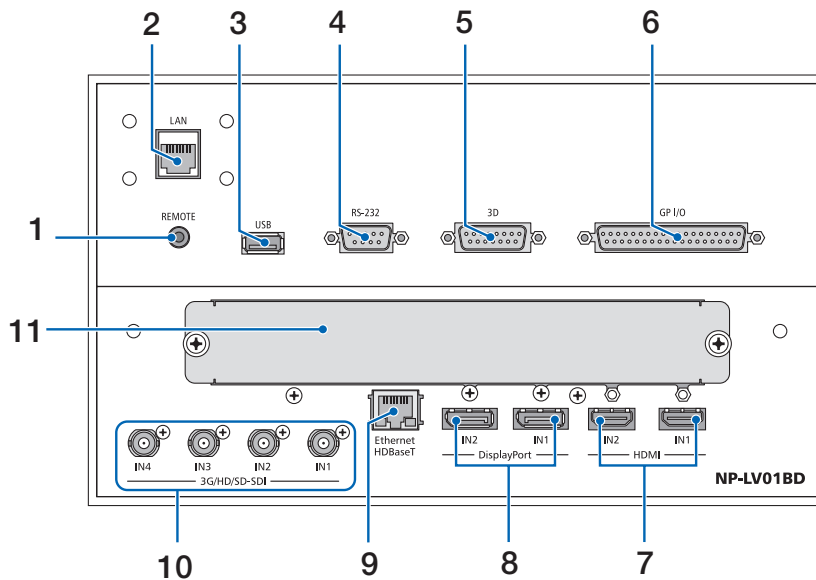

1. REMOTE Terminal [REMOTE] (Stereo Mini)

Use this jack for wired remote control of the projector using a commercially available remote cable with $\varnothing 3.5$ stereo mini-plug (without resistance).

Connect the projector and the supplied remote control using a commercially available wired remote control cable.

(→ page 15)

2. LAN port [LAN] (RJ-45)

The port for controlling the projector from a PC via a network. Connect the projector and the PC with a commercially available shielded Ethernet cable (10/100Base-T).

3. USB port [USB] (type A)

The port for the projector maintenance.

4. PC control terminal [RS-232] (D-sub 9P)

The terminal for operating the projector from a PC via an RS-232C or for service personnel to set data for the projector. Connect the projector and the PC with a commercially available shielded RS-232C straight cable.

5. 3D terminal [3D] (D-sub 15P)

The terminal for connecting a 3D image system to the projector.

Use a shielded 15pin cable (sold commercially).

6. External control terminal [GP I/O] (D-sub 37P)

The terminal for externally controlling the projector.

(→ page 156)

Use a shielded 37pin cable (sold commercially).

7. HDMI1 IN/HDMI2 IN Terminal [HDMI IN1/IN2] (Type A)

(→ page 136)

8. DisplayPort1 IN/DisplayPort2 IN Terminal [DisplayPort IN1/IN2]

(→ page 136)

9. HDBaseT Port [Ethernet HDBaseT] (RJ-45)

(→ page 136)

10. SDI1/SDI2/SDI3/SDI4 IN Terminal [3G/HD/SD-SDI IN1/IN2/IN3/IN4] (BNC)

(→ page 136)

11. SLOT

Expansion slots for installing optional boards sold separately. A plate to plug up the opening is attached when the unit is first shipped from the factory.

Controls/Indicator Panel

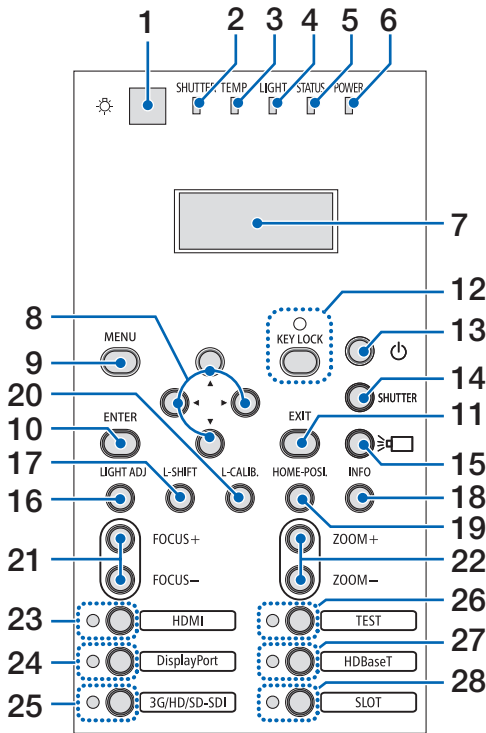

1. (Light) button
Illuminates the control panel and the indicator panel.
2. **SHUTTER** Indicator
(→ page 36, 166)
3. **TEMP.** Indicator
(→ page 166)
4. **LIGHT** Indicator
(→ page 36, 166)
5. **STATUS** Indicator
(→ page 165)
6. **POWER** Indicator
(→ page 22, 34, 165)

7. **Liquid crystal indicator panel**
The projector displays its status, input signal info, and error info whenever connected to a power source.

Information displayed

Projector status	power on/off, light source, temperature, AC in voltage
Input signal info	input terminal, entry list number, source name, horizontal frequency, vertical frequency
Error info	error code, error description

8. **▲▼◀▶** Buttons
(→ page 30, 70)

9. **MENU** Button
(→ page 70)
10. **ENTER** Button
(→ page 70)
11. **EXIT** Button
(→ page 70)
12. **KEY LOCK** Button / **KEY LOCK** Indicator
(→ page 36)
13. (**POWER**) Button
(→ page 22, 34)
14. **SHUTTER** Button
(→ page 36)
15. (**light source**) Button
(→ page 36)
16. **LIGHT ADJ** Button
(→ page 41)
17. **L-SHIFT** Button
(→ page 30)
18. **INFO** Button
 - Press the switch briefly to change the contents displayed in the liquid crystal indicator panel.
 - Press and hold the switch (for 2 seconds or more) to display the INFORMATION screen. (→ page 132)
19. **HOME-POS.** Button
(→ page 30)
20. **L-CALIB.** Button
(→ page 23)
21. **FOCUS +/-** Button
(→ page 32)
22. **ZOOM +/-** Button
(→ page 33)
23. **HDMI** Button / **HDMI** Indicator
(→ page 25)
24. **DisplayPort** Button / **DisplayPort** Indicator
(→ page 25)
25. **3G/HD/SD-SDI** Button / **3G/HD/SD-SDI** Indicator
(→ page 25)
26. **TEST** Button / **TEST** Indicator
TEST Indicator always lights up in white.
(→ page 28, 32)
27. **HDBaseT** Button / **HDBaseT** Indicator
(→ page 25)
28. **SLOT** Button / **SLOT** Indicator
(→ page 25)

4 Part Names of the Remote Control

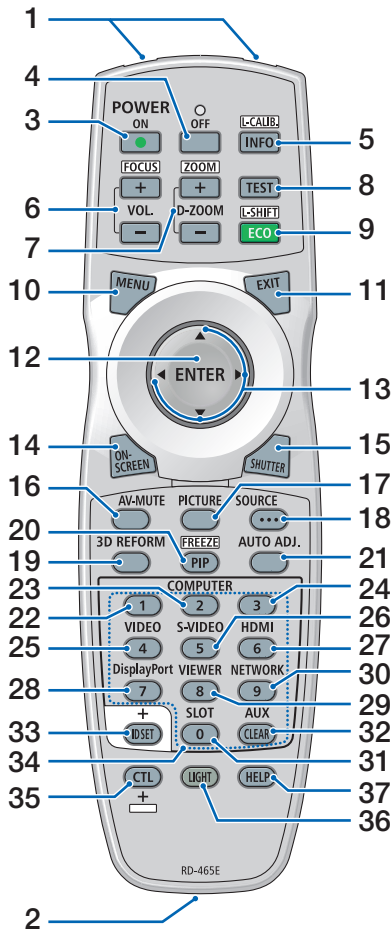

1. Infrared Transmitter

(→ page 14)

2. Remote Jack

Connect a commercially available remote cable here for wired operation. (→ page 15)

3. POWER ON Button

(→ page 22)

4. POWER OFF Button

(→ page 34)

5. INFO/L-CALIB. Button

Display the [SOURCE(1)] screen of the on-screen menu.

(→ page 132)

[LENS CALIBRATION] of the lens unit is carried out when you press the CTL button at the same time. (Applicable lens: L4K-11ZM/L4K-15ZM/L4K-20ZM)

(→ page 23)

6. VOL./FOCUS +/- Buttons

(The VOL. button function cannot be used with this series of projectors.)

(→ page 32)

7. D-ZOOM/ZOOM +/- Buttons

(→ page 40, 33)

8. TEST Button

(→ page 28, 32)

9. ECO/L-SHIFT Button

(→ page 41, 30)

10. MENU Button

(→ page 70)

11. EXIT Button

(→ page 70)

12. ENTER Button

(→ page 70)

13. ▲▼◀▶ Button

(→ page 30, 70)

14. ON-SCREEN Button

(→ page 37)

15. SHUTTER Button

(→ page 36)

16. AV-MUTE Button

(→ page 37)

17. PICTURE Button

(→ page 82)

18. SOURCE Button

(→ page 26)

19. 3D REFORM Button

(→ page 42, 44, 100)

20. PIP/FREEZE Button

(→ page 39)

21. AUTO ADJ. Button

When projecting the HDMI, DisplayPort, HDBaseT, SDI or SLOT screen, the conditions are automatically adjusted to an optimum state.

22, 23, 24. COMPUTER 1/2/3 Button

(not available on this series of projectors)

25. VIDEO Button

(not available on this series of projectors)

26. S-VIDEO Button

(not available on this series of projectors)

27. HDMI Button

(→ page 25)

28. DisplayPort Button

(→ page 25)

29. VIEWER Button

(not available on this series of projectors)

30. NETWORK Button

(→ page 25)

31. SLOT Button

(→ page 25)

32. AUX Button

(→ page 25)

33. ID SET Button

(→ page 120)

34. Numeric (0 to 9/CLEAR) Buttons

(→ page 120)

35. CTL Button

This button is used in conjunction with other buttons, similar to a CTRL key on a computer.

36. LIGHT Button

This button is used to turn on the backlight for the remote control buttons.

The backlight will turn off if no button operation is made for 10 seconds.

37. HELP Button

(→ page 132)

Battery Installation

1. Press the catch and remove the battery cover.
2. Install new ones (AA). Ensure that you have the batteries' polarity (+/-) aligned correctly.
3. Slip the cover back over the batteries until it snaps into place.

NOTE: Do not mix different types of batteries or new and old batteries.

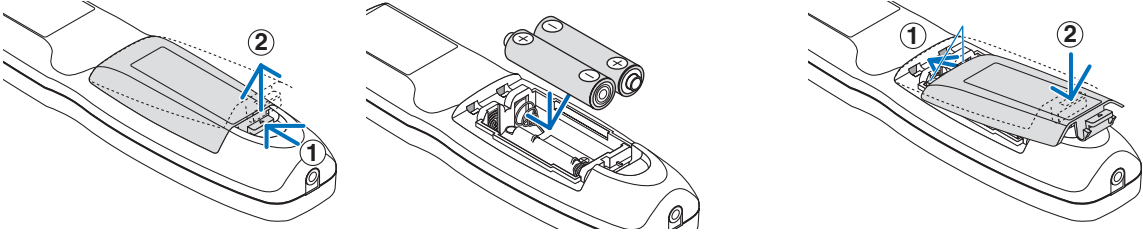

Remote Control Precautions

- Handle the remote control carefully.
- If the remote control gets wet, wipe it dry immediately.
- Avoid excessive heat and humidity.
- Do not short, heat, or take apart batteries.
- Do not throw batteries into fire.
- If you will not be using the remote control for a long time, remove the batteries.
- Ensure that you have the batteries' polarity (+/-) aligned correctly.
- Do not use new and old batteries together, or use different types of batteries together.
- Dispose of used batteries according to your local regulations.

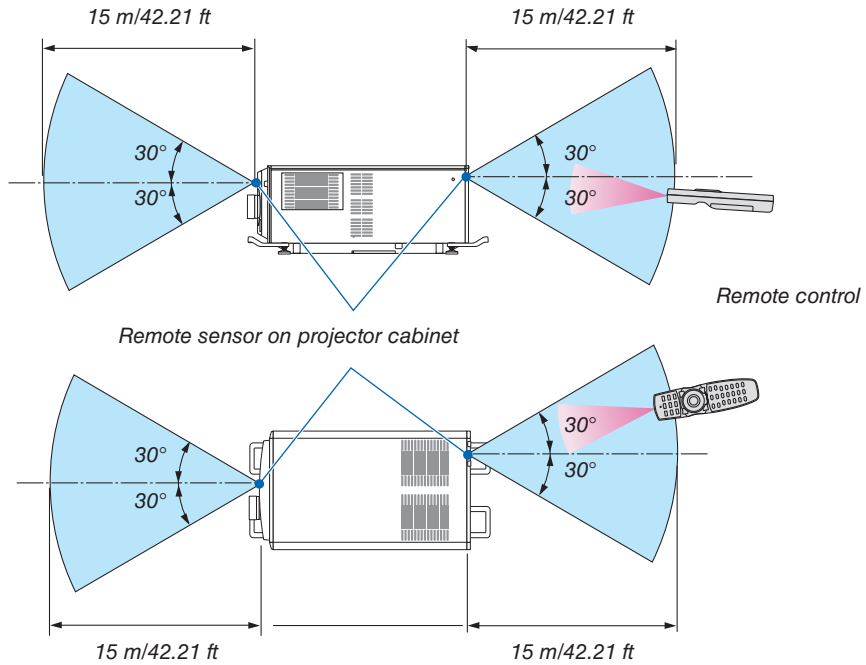
Operating Range for Wireless Remote Control

- The infrared signal operates by line-of-sight up to a distance of above meters and within a 60-degree angle of the remote sensor on the projector cabinet.
- The projector will not respond if there are objects between the remote control and the sensor, or if strong light falls on the sensor. Weak batteries will also prevent the remote control from properly operating the projector.

Using the Remote Control in Wired Operation

Connect one end of the remote cable to the REMOTE terminal and the other end to the remote jack on the remote control.

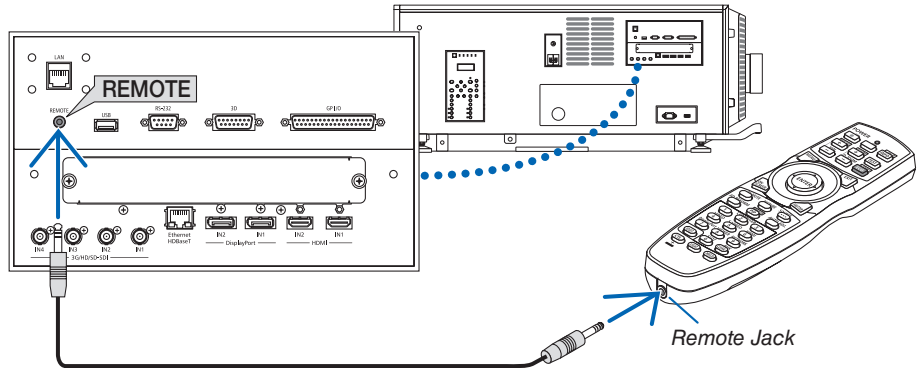

NOTE:

- When a remote cable is inserted into the REMOTE terminal, the remote control does not work for infrared wireless communication.
- Power will not be supplied to the remote control by the projector via the REMOTE jack. Battery is needed when the remote control is used in wired operation.
- When [HDBaseT] is selected in the [REMOTE SENSOR] and the projector is connected to a commercially-available transmission device that supports HDBaseT, remote control operations in infra-red cannot be carried out if transmission of remote control signals has been set up in the transmission device. However, remote control using infrared rays can be carried out when the power supply of the transmission device is switched off.

2. Projecting an Image (Basic Operation)

This section describes how to power on the projector and to project a picture onto the screen.

① Flow of Projecting an Image

Step 1

- *Connecting the power cable* (→ [page 17](#))



Step 2

- *Connecting your computer* (→ [page 20](#))



Step 3

- *Turning on the projector* (→ [page 21](#))



Step 4

- *Selecting a source* (→ [page 25](#))



Step 5

- *Adjusting the picture size and position* (→ [page 28](#))



Step 6

- *Adjusting a picture*



Step 7

- *Turning off the projector* (→ [page 34](#))

② Connecting the Power Cable

Consult your distributor for installing the power cable to the projector.

If AC power is supplied to the projector and light with one power cable (C1 connection), it is not necessary to connect the cable to the projector power supply.

The power cable is not included with the projector. Use a power cable that meets the standards and power supply voltage of the country where you are using the projector. Ask your distributor for the power cable to select and purchase.

WARNING

- Consult your distributor for installing the power cable to the projector. **DO NOT** install the power cable by yourself. Doing so may cause a fire or electric shock.
- Before connecting the power cables, check that the projector power switch and light power switch of the projector is turned off. Implement the connection with AC power shut off.
- Be sure to ground the equipment to ensure safety. Use a power cable that meets the standards and power supply voltage of the country where you are using the projector, and always connect the equipment to the ground. If the ground is not connected, it may cause electrical shocks.
- When connecting the power cable plugs to the AC IN and the electrical outlet, securely insert the plugs all the way in.
For C2 connection, be sure to install the power cable stopper.
If the connection between the power cable plug and the electrical outlet is loose, the plug area may generate heat, causing burns and accidents.

1. Connect the AC power supply cable.

Connect the AC power supply cable to the projector.

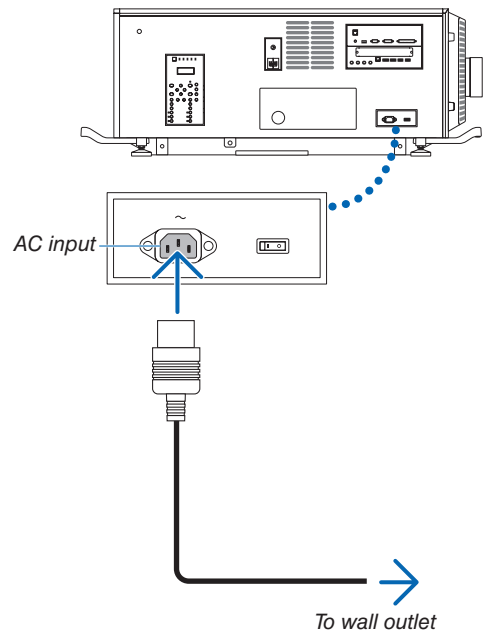

2. Connect the power plug to the electrical outlet.

This completes the connection of the AC power supply cable.

2. Projecting an Image (Basic Operation)

Attaching the power cable stopper

To prevent the power cable from accidentally removing from the AC IN of the projector, attach the supplied power cable stopper to clamp the power cable.

CAUTION

- To prevent the power cable from coming loose, make sure that all the prongs of the power cable are fully inserted into the AC IN terminal of the projector before using the power cable stopper to fix the power cable. A loose contact of the power cable may cause a fire or electric shock.
- Do not bundle the power cable. Doing this could cause heat or a fire.

NOTE

- Do not clamp the power cable with other cables. Doing so can generate noise, which can affect adversely the signal cable.
- Be careful not to insert the band inversely. Once the band is attached, it cannot be removed from the slot.

1. **Set the clamber band to the power cable side, and insert the end of band of the power cable stopper into the slot next to the AC IN on the terminal panel.**

Attach the power cable stopper to the other side in the same way.

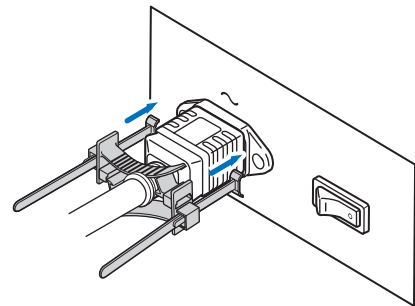

2. **Pass each band through the slits in the power cable stopper.**

Pass the bands through them so that the power cable will be sandwiched from above and below.

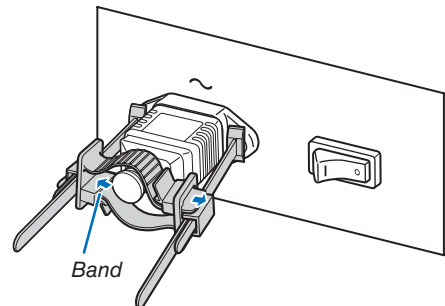

3. **Slide the clamber to the hilt of the power cable.**

Pulling the knob in the arrow direction allows you to adjust the clamber position.

Once the clamber position is adjusted, release the knob to lock the clamber.

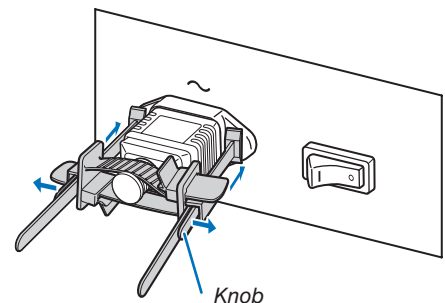

2. Projecting an Image (Basic Operation)

4. Pull the band to hold the power cable.

Pulling the knob in the arrow direction allows you to adjust the band position.

Pull the top and bottom bands by keeping their balance.

Once the band position is adjusted, release the knob to lock.

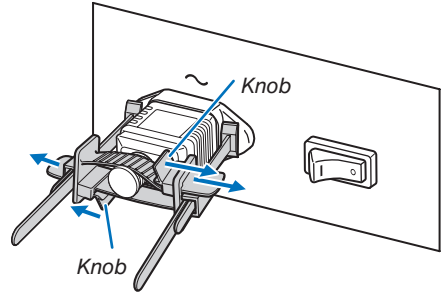

This completes the attachment of the power cable stopper.

Removing the power cable from the power cable stopper

1. Pull the knob of the clammer and loosen the band.

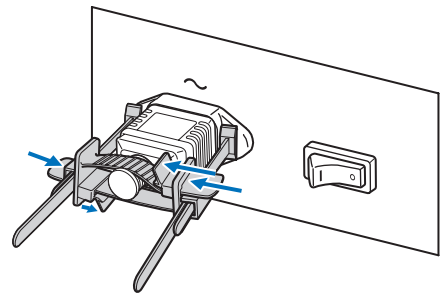

2. Pull the knob and slide the clammer away from the power plug.

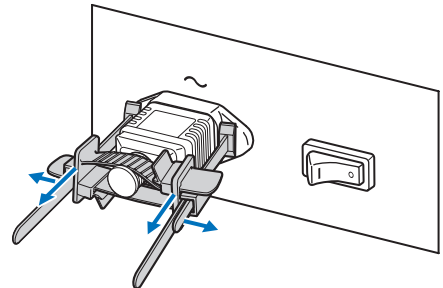

CAUTION

- The projector may become hot temporarily when the power is turned off or if the AC power is disconnected while the projector is projecting. Take care when handling the projector.

③ Connecting Your Computer

- **Connect your computer to the projector.**

This section will show you a basic connection to a computer. For information about other connections, see “6. Connecting to Other Equipment” on page 136.

Connect the HDMI output terminal of the computer to the HDMI1 or HDMI2 input terminal of the unit.

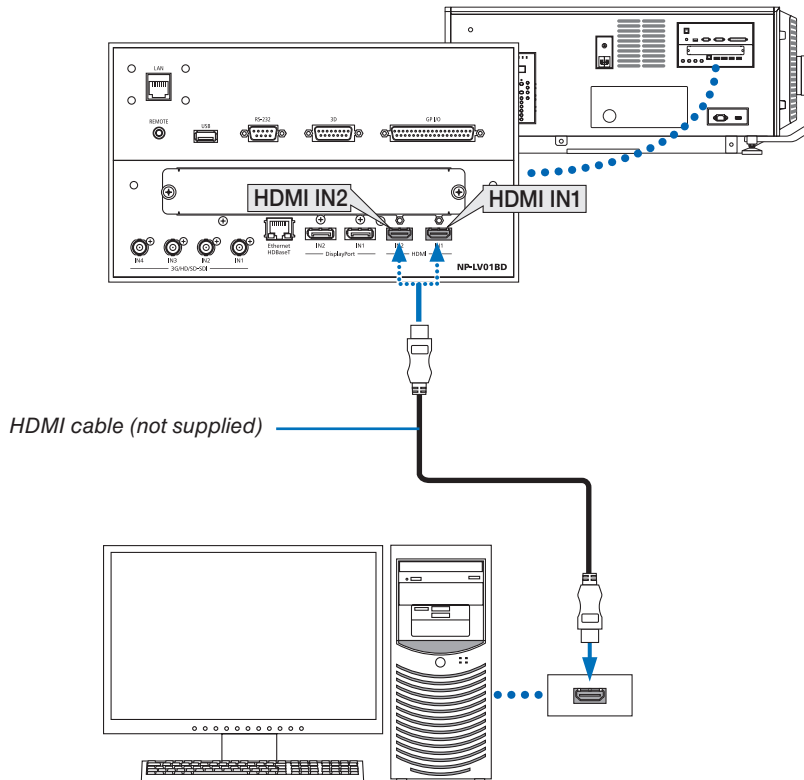

4 Turning on the Projector

Please contact your dealer/distributor to connect the power cable.

Preparation:

- Connect the power cable to the projector. (→ page 17)
- Supply AC power to the projector.

NOTE:

- Turn off the projector power switch and light power switch to the projector when supplying or cutting AC power to the projector. Supplying or shutting down the AC power while the projector power switch and light power switch is on will damage the projector.
- Turning on and off the projector involves a two-step operation; the “projector power switch and light power switch” and the “POWER button” (POWER ON and OFF on the remote control).

Turning power on. (See this page)

1. Turn on the “projector power switch and light power switch” of the projector.

Your projector is set in a standby state.

2. Press the  (POWER) button on the projector cabinet or the POWER ON button on the remote control.

Your projector is turn on.

Turning power off. (→ page 34)

1. Press the  (POWER) button on the projector cabinet or the POWER OFF button on the remote control.

The confirmation message will be displayed.

2. Press the  (POWER) button or the POWER OFF button again.

Your projector is set in a standby state.

3. Turn off the “projector power switch and light power switch” of the projector.

Your projector is turned off.

1. Remove the lens cap.

2. Insert the administrator key vertically, and turn it to the right.

The administrator key can no longer be removed. The projector will not function unless the administrator key is inserted.

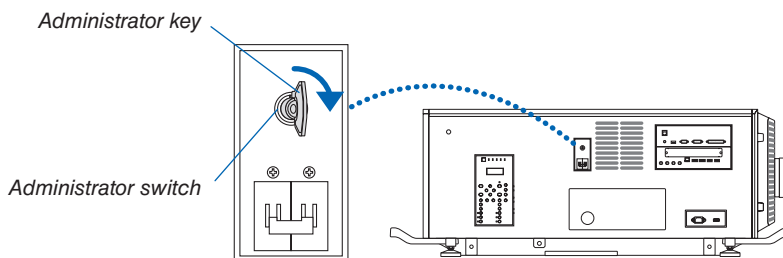

2. Projecting an Image (Basic Operation)

3. Turn on the light power switch ([1]) then the projector power switch ([2]) on the side of the projector.

The POWER indicator lights up orange.

- The buzzer sound is released when [NOTIFICATION SETTING] for [BUZZER] is ON.

(→ page 119)

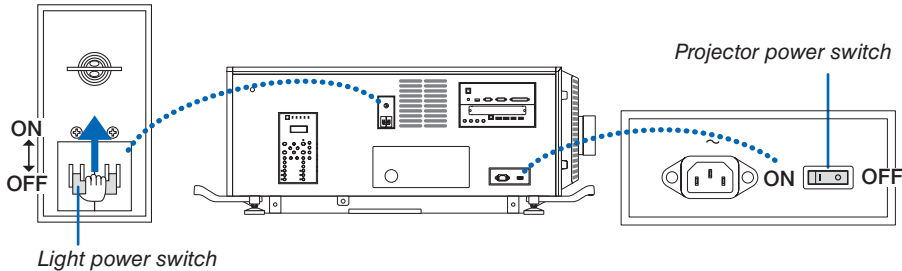

WARNING

The projector produces a strong light. When turning on the power, make sure no one within projection range is looking at the lens.

4. Press the (POWER) button on the projector cabinet or the POWER ON button on the remote control.

The POWER indicator goes from a steady orange light to a steady green light, and the picture is projected on the screen.

- If using the remote control, press the POWER ON button.
- When there is no signal the unit will project a blue screen (factory default menu settings).
- If the picture is blurry, adjust the screen focus. (→ page 32)
- When it is dark press the  (lights) button. The indicator panel backlight and the LED lamp on the right side of the projector will turn on. (→ page 11)

TIP:

- The lens shutter remains closed even when the power is turned on with the Power On Shutter function. (→ page 116)
- Pressing the button will not activate the unit when the KEYLOCK indicator is flashing orange. (→ page 36)
- When the message "PROJECTOR IS LOCKED! ENTER YOUR PASSWORD." is displayed, it means that the [SECURITY] feature is turned on. (→ page 45)

After you power on your projector, ensure that the computer or video source is turned on.

NOTE: The blue screen ([BLUE] background) is displayed when no signal is being input (by factory default menu settings).

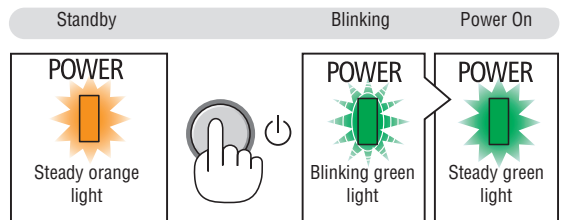
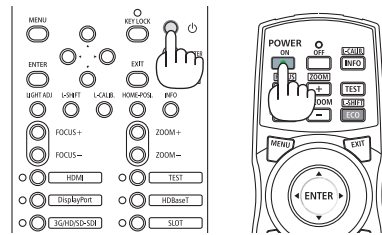

(→ page 165)

2. Projecting an Image (Basic Operation)

Performing Lens Calibration

- After installing the lens unit L4K-11ZM/L4K-15ZM/L4K-20ZM (sold separately), press the L-CALIB. button on the projector, or hold down the CTL button on the remote control then press the INFO/L-CALIB. button to carry out [LENS CALIBRATION].

By carrying out [LENS CALIBRATION], the adjustment range of the zoom of the [LENS MEMORY] is calibrated. If you need to install or replace the lens unit, contact your distributor and have them do it for you.

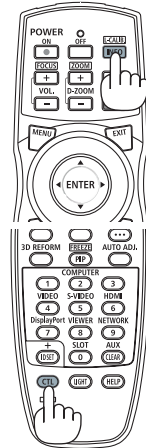
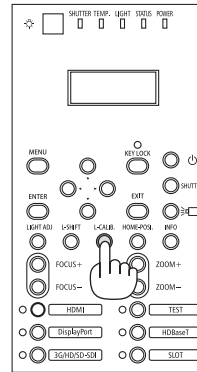

2. Projecting an Image (Basic Operation)

Note on Startup screen (Menu Language Select screen)

When you first power on the projector, you will get the Startup menu. This menu gives you the opportunity to select one of the 30 menu languages.

To select a menu language, follow these steps:

1. Use the ▲, ▼, ◀ or ▶ button to select one of the 30 languages from the menu.

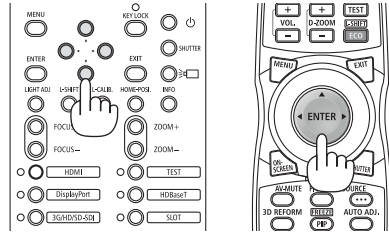

2. Press the ENTER button to execute the selection.

After this has been done, you can proceed to the menu operation.

If you want, you can select the menu language later. (→ [LANGUAGE] on page 74 and 108)

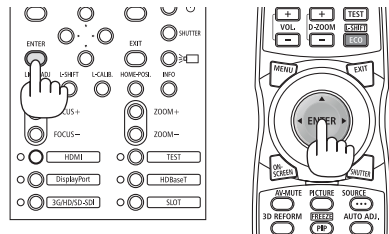

NOTE:

- If the message, [PLEASE SET "DATE AND TIME".] is shown, please set the current date and time. (→ page 119)
- When the KEY LOCK indicator is flashing, that means [CONTROL PANEL LOCK] has been set and pressing the (⏻) button will not cause the unit to power-on. Release [CONTROL PANEL LOCK]. (→ page 36)
- While the POWER indicator is blinking green in short cycles, the power cannot be turned off by using the power button. (While the POWER indicator is blinking green in long cycles, the [OFF TIMER] is functioned and the power can be turned off.)

5 Selecting a Source

Selecting the computer or video source

NOTE: Turn on the computer or video source equipment connected to the projector.

Using the Direct button

Press the Direct button on the projector cabinet or remote control.
Select the input according to the connection terminal.

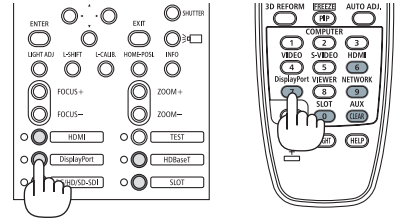

Input connector	Button on the projector cabinet	Button on the remote control	Note
HDMI1/2 IN	HDMI	HDMI	Switches between HDMI1 and HDMI2 each time it is pressed.
DisplayPort 1/2 IN	DisplayPort	DisplayPort	<ul style="list-style-type: none"> Switches between DisplayPort1 and DisplayPort2 each time it is pressed. Select DisplayPort1 for dual link.
SDI 1/2/3/4 IN	3G/HD/SD-SDI	AUX	<ul style="list-style-type: none"> Switches between SDI1, SDI2, SDI3 and SDI4 each time it is pressed. Select SDI1 for quad link or dual link.
HDBaseT	HDBaseT	NETWORK	—
SLOT	SLOT	SLOT	—

NOTE:

- The indicator next to each button on the main unit operation area operates as follows.
 - When a signal is input: lights up in white.
 - * For SLOT, this is when optional boards (sold separately) are installed and the power is on.
 - When an input is selected: lights up in green.

2. Projecting an Image (Basic Operation)

Detecting the Signal Automatically

Press the SOURCE button for 1 second or longer. The projector will search for the available input source and display it. The input source will change as follows:

HDMI1 → HDMI2 → DisplayPort1 → DisplayPort2 → HDBaseT → SDI1 → SDI2 → SDI3 → SDI4 → SLOT.....

TIP: If no input signal is present, the input will be skipped.

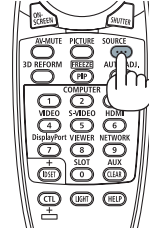

- Press it briefly to display the [INPUT] screen.

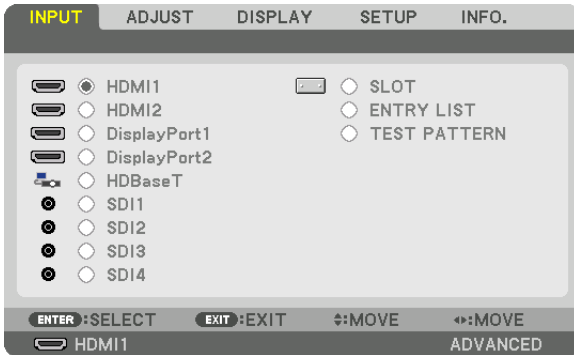

Press the ▼/▲ buttons to match the target input terminal and then press the ENTER button to switch the input. To delete the menu display in the [INPUT] screen, press the MENU or EXIT button.

Selecting Default Source

You can set a source as the default source so that it will be displayed each time the projector is turned on.

1. Press the MENU button.

The menu will be displayed.

2. Press the ► button to select [SETUP] and press the ▼ button or the ENTER button to select [MENU(1)].

3. Press the ► button to select [SOURCE OPTIONS(1)].

4. Press the ▼ button to select [DEFAULT INPUT SELECT] and press the ENTER button.

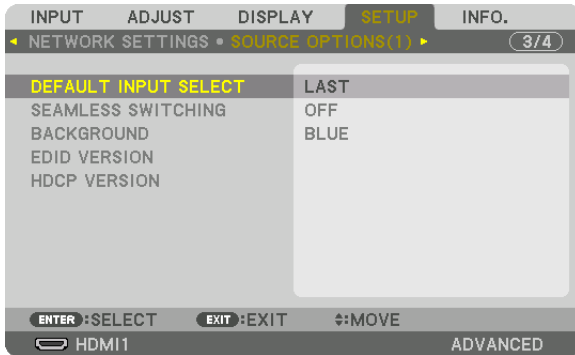

The [DEFAULT INPUT SELECT] screen will be displayed.

(→ page 127)

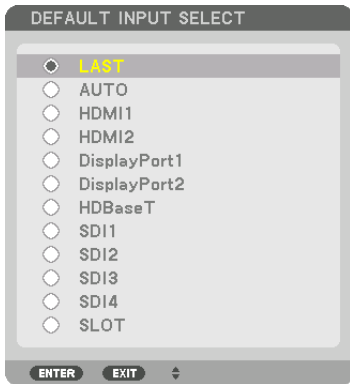

5. Select a source as the default source, and press the ENTER button.

6. Press the EXIT button three times to close the menu.

7. Restart the projector.

The source you selected in step 5 will be projected.

NOTE: Even when [AUTO] is turned on, the [HDBaseT] will not be automatically selected. To set your network as the default source, select [HDBaseT].

TIP:

- When the projector is in Standby mode, applying a computer signal from a computer will power on the projector and simultaneously project the computer's image.

([AUTO POWER ON SELECT] → page 129)

6 Adjusting the Picture Size and Position

Adjusting the projector's settings
[Level adjuster]
(→ page 29)

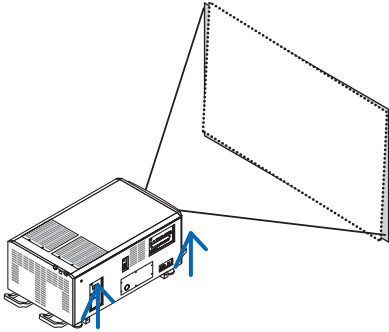

Adjusting the projected image's vertical and horizontal position
[Lens shift]
(→ page 30)

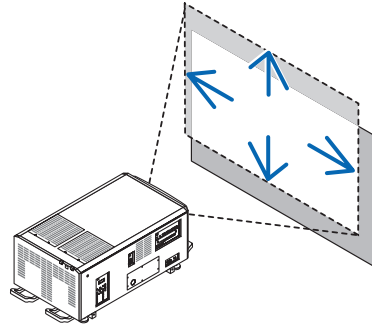

Adjusting the focus
[Focus]
(→ page 32)

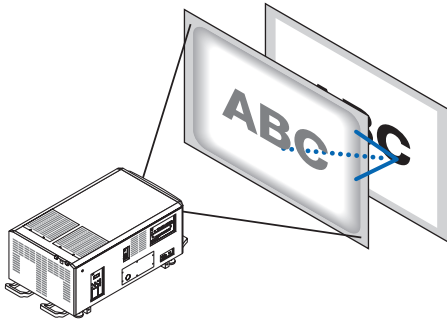

Finely adjusting the size of an image
[Zoom]
(→ page 33)

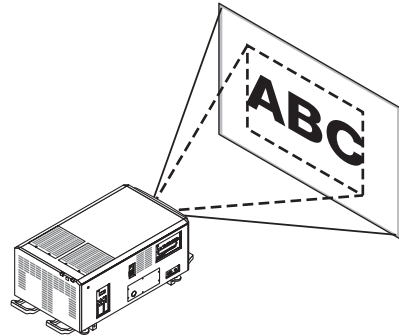

In this chapter drawings and cables are omitted for clarity.

TIP:

- Built-in test patterns can be conveniently used for adjusting the picture size and position. A press of the TEST button will display the test pattern. The ◀ or ▶ button can select one test pattern. To close the test pattern, change the source to another.

2. Projecting an Image (Basic Operation)



CAUTION

- Perform the adjustment from behind or from the side of the projector. Adjusting from the front could expose your eyes to strong light which could injure them.
- Keep hands away from the lens mounting portion while the lens shift is in operation. Failure to do so could result in hands being pinched by the moving lens.

Adjustment of the projector's settings (Level adjusters)

The projector must be placed square to the screen otherwise keystone distortion may appear on the screen. For setting the projector perpendicular to the screen when viewed from the side, utilizing the level adjusters equipped at each corner of the projector bottom. Maximum Adjustable length of the level adjuster is 10 mm/0.39".

Example for adjustment

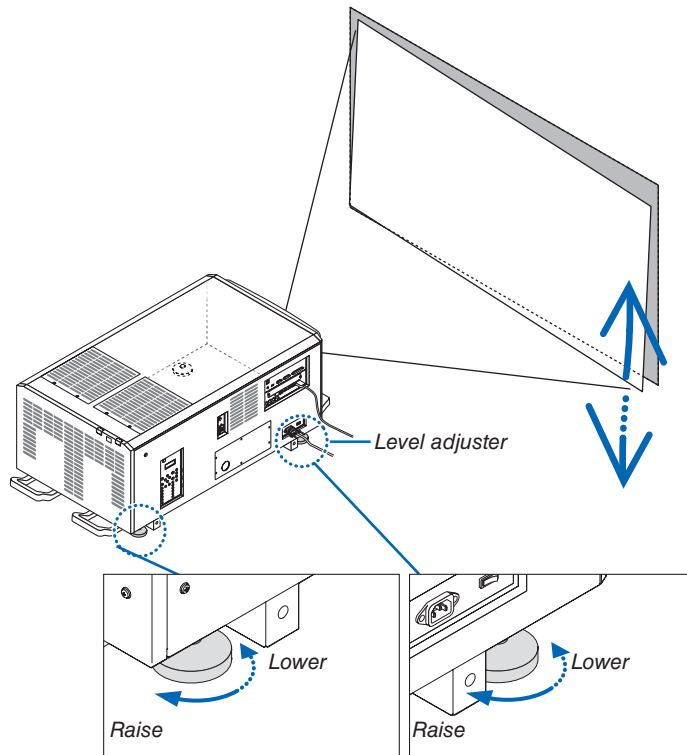

NOTE:

- Do not lengthen each of the level adjusters any more than 10 mm/0.39". The force of doing so may cause the level adjuster to come off, resulting in damage to the projector.
- Pay attention to lengthen or shorten two level adjusters at front at the same time. Same for the rear adjusters, otherwise, the weight of the projector is loaded on one level adjuster and it may cause of damage to it.

2. Projecting an Image (Basic Operation)

Adjusting the vertical position of a projected image (Lens shift)

NOTE:

- Shifting the lens to the maximum in two directions combined will cause the edges of the image to become dark or will cause some shadows.

Adjusting with buttons on the cabinet

1. Press the L-SHIFT button.

The [LENS SHIFT] screen will be displayed.

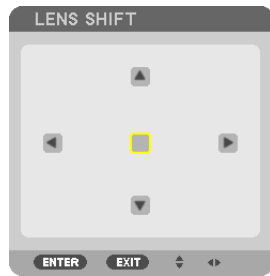

2. Press the ▼▲◀▶ or ▶ button.

Use the ▼▲◀▶ buttons to move the projected image.

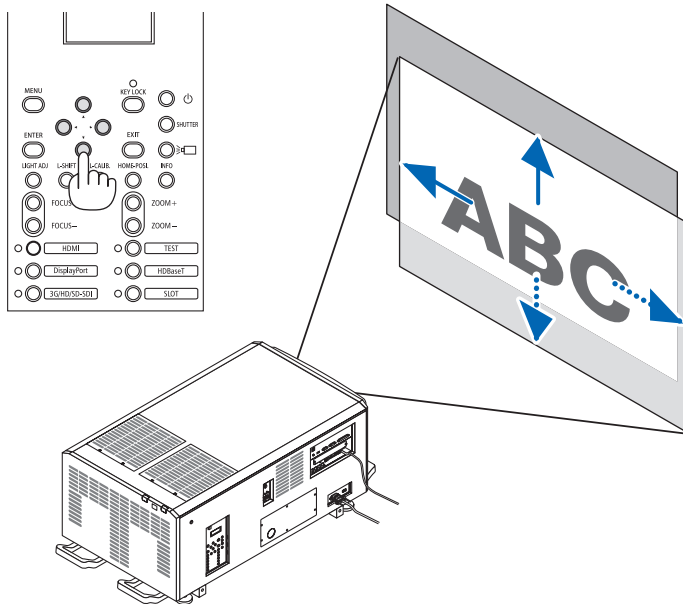

- Returning the lens shift position to the home position

Press the HOME-POS1. button to return the lens shift position to the home position (nearly center position)

2. Projecting an Image (Basic Operation)

Adjusting with the remote control

1. Hold the CTL button and press the ECO/L-SHIFT button.

The [LENS SHIFT] screen will be displayed.

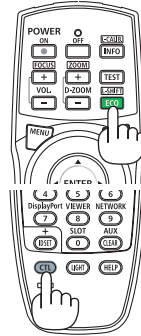
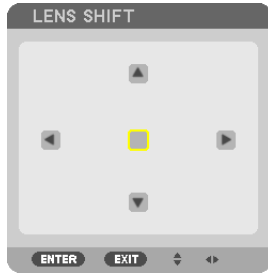

2. Press the \blacktriangledown \blacktriangleleft or \blacktriangleright \blacktriangleup button.

Use the \blacktriangledown \blacktriangleleft \blacktriangleright \blacktriangleup buttons to move the projected image.



TIP:

- The figure below shows the lens shift ranges (projection mode: desktop/front) for 3840×2160 images (16:9 aspect ratio) for the L4K-11ZM, L4K-15ZM and L4K-20ZM lens units. See page 147 for the details of other lenses.

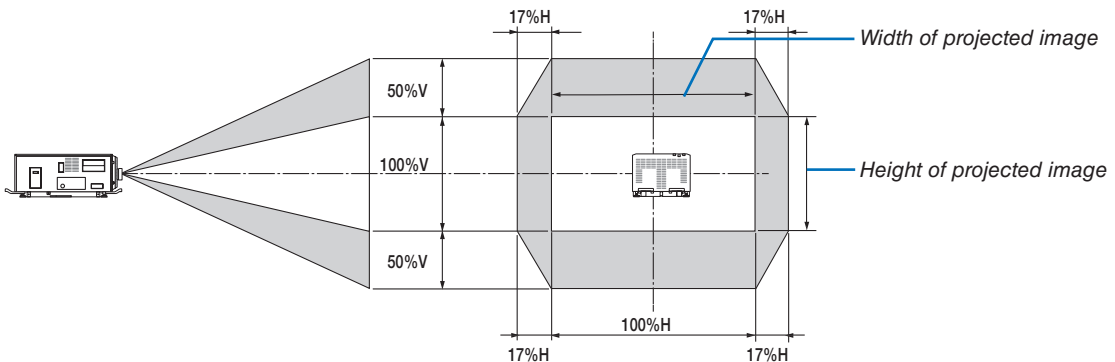

Description of symbols: V indicates vertical (height of the projected image), H indicates horizontal (width of the projected image).

Focus

1. Press the FOCUS +/- button.

The FOCUS adjustment bar will be displayed on.



The focus is adjusted.

- On the remote control, while pressing on the CTL button, press on VOL/FOCUS (+) or (-) button.
- ◀ or ▶ buttons on the cabinet or the remote control are also available to adjust FOCUS while the FOCUS adjustment bar is displayed on.

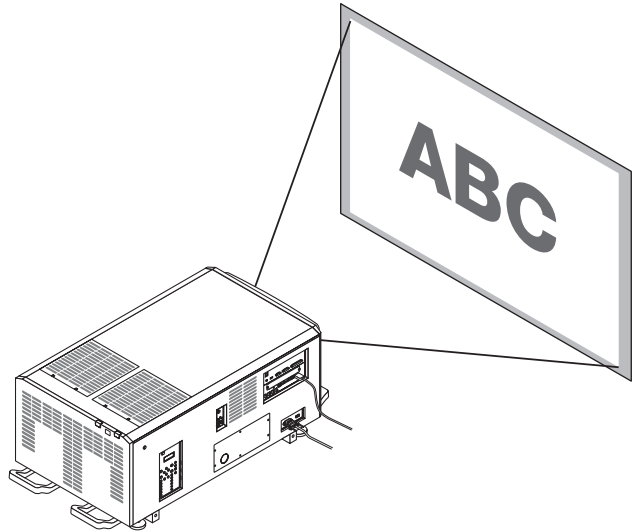
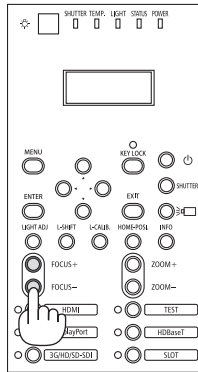
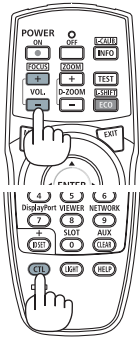

TIP: To obtain the best focus, perform the following (for fixed installation)

Preparation: Warm up the projector for one hour.

1. Use the FOCUS +/- buttons to make sure you obtain the best focus. If you do not, move the projector back and forth.
2. Press the TEST button on the remote control to display the test pattern.
3. Keep pressing the FOCUS - button until the grid of the text pattern is made invisible.
4. Keep pressing the FOCUS + button until you obtain the best focus.

If you adjust beyond the best focal point, go back to step 3 and repeat the procedures.

Zoom

1. Press the ZOOM +/- button.

The ZOOM adjustment bar will be displayed on.



The zoom is adjusted.

- On the remote control, while pressing on the CTL button, press the D-ZOOM/ZOOM (+) or (-) button.
- ◀ or ▶ buttons on the cabinet or the remote control are available to adjust ZOOM while the ZOOM adjustment bar is displayed on.
- The zoom of the lens unit L2K-10F1 cannot be adjusted.

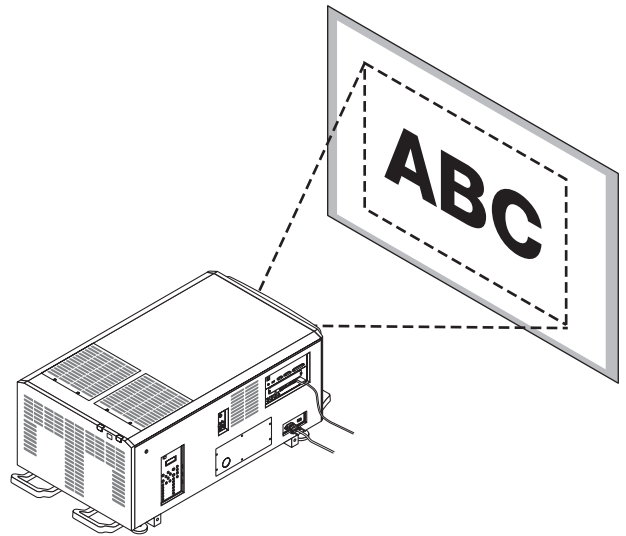
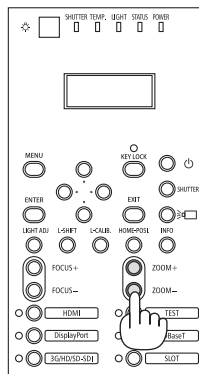
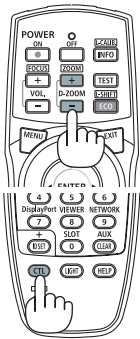

7 Turning off the Projector

To turn off the projector:

1. First, press the  (POWER) button on the projector cabinet or the POWER OFF button on the remote control.

The [POWER OFF / ARE YOU SURE ?] message will appear.

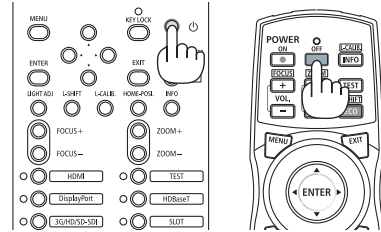

2. Secondly, press the ENTER button or press the  (POWER) or the POWER OFF button again.

When the projector is in STANDBY MODE, the POWER indicator lights up orange.

- Before the POWER indicator lights up orange, the buzzer sound is released when [NOTIFICATION SETTING] for [BUZZER] is ON.

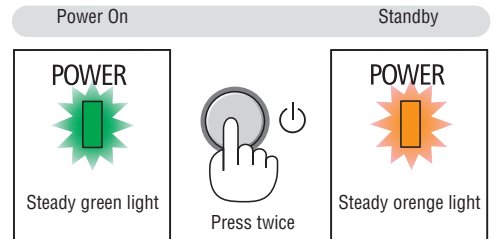

3. After the projector enters the standby state, turn off the projector power switch ([1]), then the light power switch ([2]).

The POWER indicator will go off and the main power will turn off.

- While the POWER indicator is blinking green in short cycles, the power cannot be turned off.

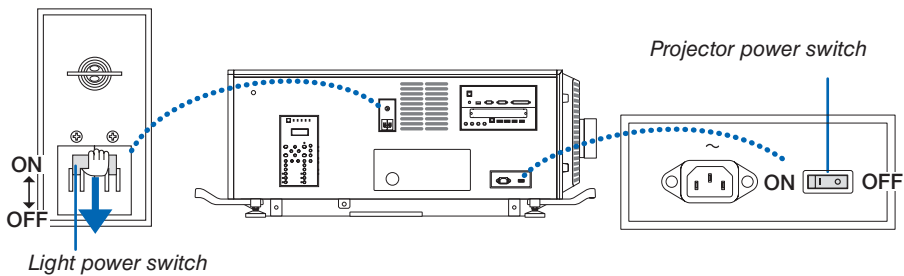

4. Return the administrator switch to the OFF position, then remove the administrator key.

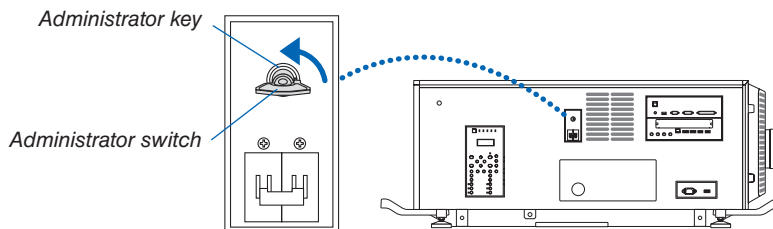

5. Turn off the AC power to the projector.

2. Projecting an Image (Basic Operation)

NOTE:

- *In the following instances, do not turn off the projector power switch and light power switch or disconnect the AC power. Doing so can damage the projector.*
 - *While projecting images*
 - *While the power is on*
 - *During the cooling after the power is turned off.*
 - *After you have made the adjustments and closed the adjustment screen, do not turn off the projector power switch and light source power switch, or pull out the power plug from the wall outlet, or shut down the AC power supply for about 10 seconds. The adjustment values may be initialized if the AC power supply is shut down during this time.*
-

3. Convenient Features

1 Stopping projection

- 1 Press the **SHUTTER** button on the projector or on the remote control.

The lens shutter closes and the projected light disappears temporarily. The **SHUTTER** indicator will turn on in green.

- Press the button again to open the lens shutter and project the picture. The **SHUTTER** indicator will turn off.
- You can set the projection light to gradually fade in or fade out.

On the projector
SHUTTER indicator

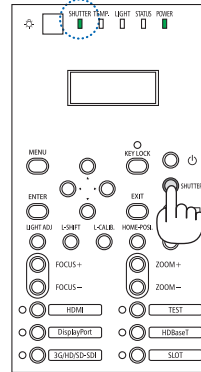

On the remote

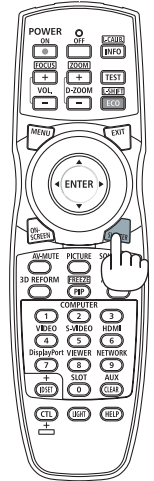

2 Turning off the light source

- 1 Press the  (light source) button on the projector.

Directly turn off the light source. The **LIGHT** indicator will turn off.

- Press the  (light source) button again, the **LIGHT** indicator will flash in green.

LIGHT indicator

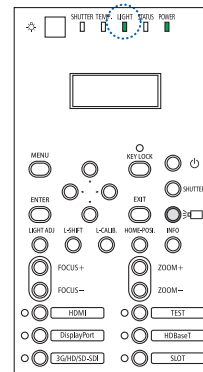

3 Locking the projector so it cannot be operated

- 1 Press the **KEY LOCK** button for over 1 second on the projector.

The **KEY LOCK** indicator will turn on in orange and all the projector's operating buttons will be locked.

- Press the **KEY LOCK** button for over 1 second again to turn off the **KEY LOCK** indicator and unlock the buttons.

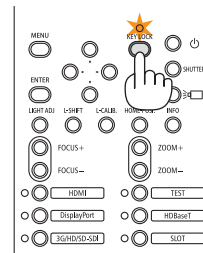

- TIP:
- When [CONTROL PANEL LOCK] is engaged a “” icon appears in the lower right-hand corner of the menu screen.
 - The projector can still be operated using the remote control even when the buttons on the unit are locked.

4 Muting the Image (AV Mute)

Press the AV-MUTE button to turn off the image for a short period of time. Press again to restore the image.

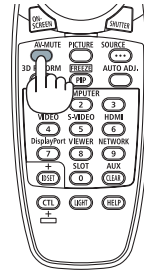

TIP:

- The image will disappear but not the menu display.

5 Turning Off the On-Screen Menu (On-Screen Mute)

A press of the ON-SCREEN button on the remote control will hide the on-screen menu, the source display and other messages. The SHUTTER indicator will turn on in orange. Press again to restore them. The SHUTTER indicator will turn off.

SHUTTER indicator

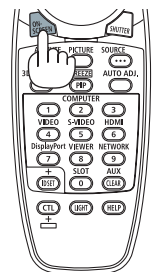
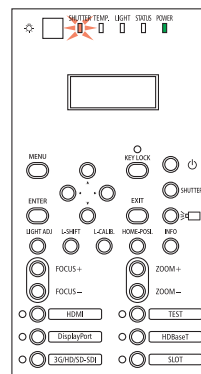

TIP:

- To confirm that the on-screen mute is turned on, press the MENU button. If the on-screen menu is not displayed even though you press the MENU button, it means the on-screen mute is turned on.
- The on-screen mute is maintained even when the projector is turned off,
- Holding down the MENU button for at least 10 seconds will turn off the on-screen mute.

⑥ Shift the On-Screen Menu displaying position

1. Press the **MENU** button.

The On-Screen Menu will be displayed on.

2. Move the cursor by the **▶** button to the **[SETUP]** and then press the **ENTER** button.

The cursor will move to the **[MENU(1)]**.

3. Move the cursor by the **▶** button to the **[MENU(2)]**.

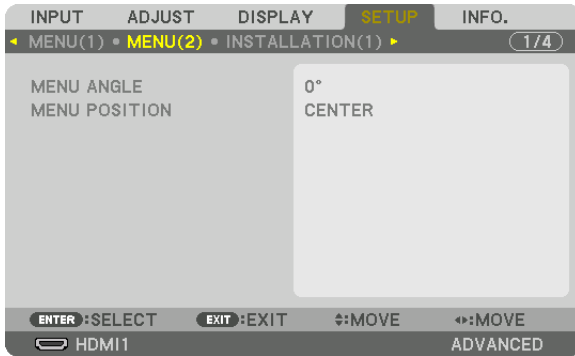

4. Move the cursor by the **▼** button to the **[MENU POSITION]** and then press the **ENTER**.

The On-Screen Menu will go into the **[MENU POSITION]** select screen.



5. Press the **▼▲** button, select the menu position, and press the **ENTER** button.

For finishing the setting on the On-Screen Menu, press the **MENU** button on the remote control.

TIP:

- The display position of the menu is saved even when the power supply of the projector is turned off.
- When you change the **[MENU ANGLE]**, the display position of the menu returns to the original state when it was first shipped from the factory.
- This function does not influence to the display position of input terminal information and message.

7 Freezing a Picture

Hold the CTL button and press the PIP/FREEZE button to freeze a picture.
Press again to resume motion.

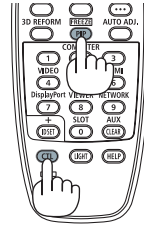

NOTE: The image is frozen but the original video is still playing ahead.

8 Magnifying a Picture

You can magnify the picture up to four times.

NOTE:

- Depending on an input signal, the maximum magnification may be less than four times, or the function may be restricted.

To do so:

1. Press the D-ZOOM (+) button to magnify the picture.

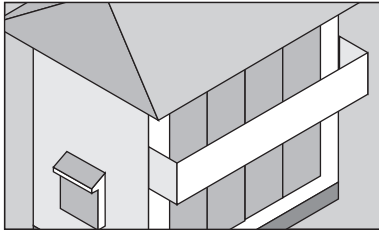
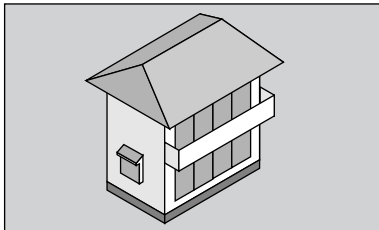

2. Press the ▲▼◀▶ button.

The area of the magnified image will be moved

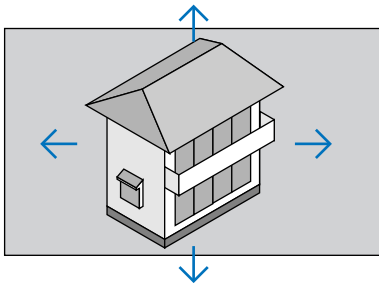

3. Press the D-ZOOM (-) button.

Each time the D-ZOOM (-) button is pressed, the image is demagnified.



NOTE:

- The image will be magnified or demagnified at the center of the screen.
- Displaying the menu will cancel the current magnification.

9 Adjusting the brightness [LIGHT MODE]

When the light mode is set, you can adjust the output of the unit to a range of 30* - 100% (in increments of 1%) and control the brightness after adjustment to keep it constant.

* PH2601QL: 40%

There are two ways to set the light mode.

Function name	Description	Page
REF. LIGHT MODE	Adjust the brightness and save it as a common value for all input signals. Valid when the [MODE] (→ page 82) is set to [STANDARD].	112
LIGHT MODE	Adjust the brightness and save it for each input signal. Valid when the [MODE] (→ page 82) is set to [PROFESSIONAL].	84

1. Press LIGHT ADJ button on the cabinet.

- In another way, press ECO/L-SHIFT button on the remote control.

When [STANDARD] is selected for [MODE]



The [REF. LIGHT MODE] screen will be displayed.

When [PROFESSIONAL] is selected for [MODE]



The [LIGHT MODE] screen will be displayed.

2. Press the ◀▶ button to adjust.

To keep the brightness after adjustment constant, set [CONSTANT BRIGHTNESS] to [ON].

Press the MENU button to cancel the menu screen.

TIP:

- Brightness normally decreases with use, but by selecting [CONSTANT BRIGHTNESS] mode, sensors inside the projector detect brightness and automatically adjust the output, thereby maintaining a constant brightness throughout the life of the light module. However, if output is already at its maximum, brightness will decrease with use.

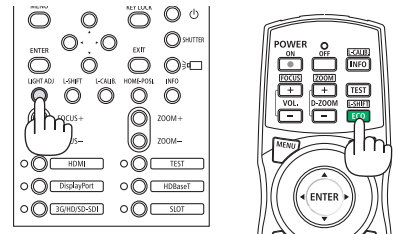

⑩ Correcting Horizontal and Vertical Keystone Distortion [CORNERSTONE]

Use the [CORNERSTONE] feature to correct keystone (trapezoidal) distortion to make the top or bottom and the left or right side of the screen longer or shorter so that the projected image is rectangular.

1. Project an image so that the screen is smaller than the area of the raster.

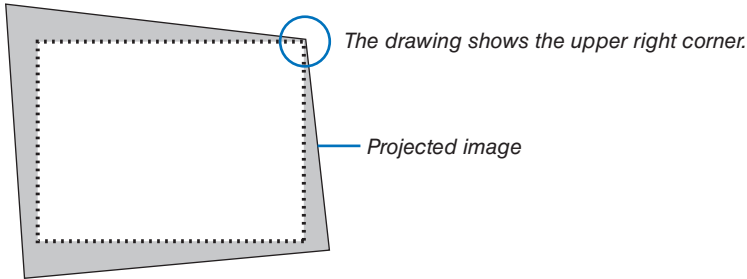

2. Pick up any one of the corners and align the corner of the image with a corner of the screen.

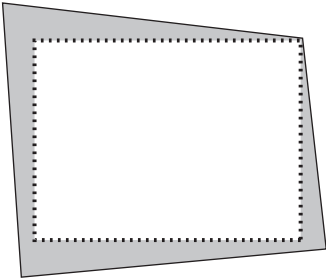

3. Press the 3D REFORM button on the remote control.

Display the [GEOMETRIC CORRECTION] screen of the on-screen menu.

4. Move the cursor onto [MODE] by ▼ button and press the ENTER.

The mode selection screen will displayed on.

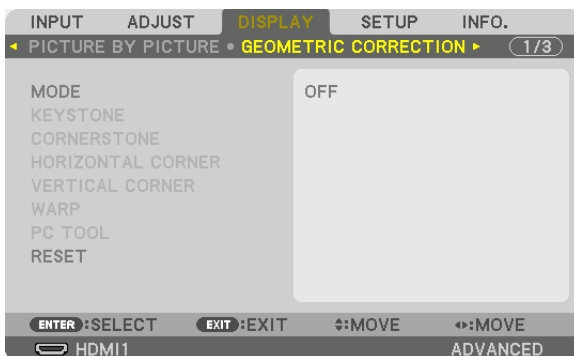

5. Select [CORNERSTONE] and press the ENTER.

Go back to display the [GEOMETRIC CORRECTION] screen of the on-screen menu.

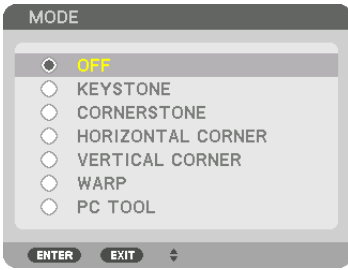

6. Press the ▼ button to align with the [CORNERSTONE] and then press the ENTER button.



The drawing shows the upper left icon (▲) is selected.

The screen will switch to the [CORNERSTONE] screen.

7. Use the ▲▼◀▶ button to select one icon (▲) which points in the direction you wish to move the projected image frame.
8. Press the ENTER button.
9. Use the ▲▼◀▶ button to move the projected image frame as shown on the example.

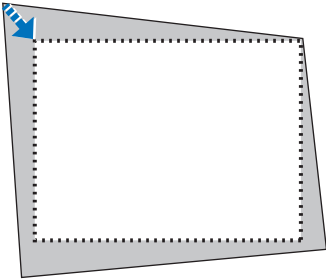

10. Press the ENTER button.

11. Use the ▲▼◀▶ button to select another icon which points in the direction.

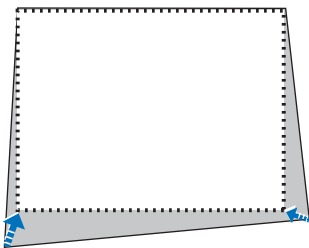

On the [CORNERSTONE] screen, select [EXIT] or press the EXIT button on the remote control.

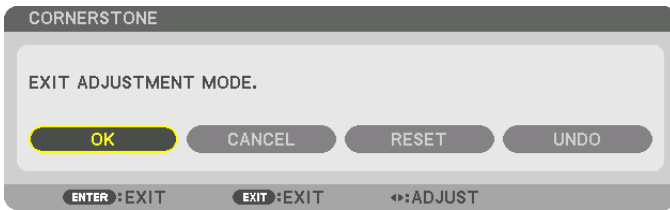

The confirmation screen is displayed.

12. Press the ◀ or ▶ button to highlight the [OK] and press the ENTER button.

This completes the [CORNERSTONE] correction.

- Select [CANCEL] and press the ENTER button to return to the [CORNERSTONE] screen.

Selecting [CANCEL] will return to the adjustment screen without saving changes (Step 3).

Selecting [RESET] will return to the factory default.

Selecting [UNDO] will exit without saving changes.

NOTE:

- Even when the projector is turned on, the last used correction values are applied.
 - Carry out either one of the following actions to clear the adjustment value of [CORNERSTONE].
 - In Step 11, select [RESET] and then press the ENTER button.
 - In the state [CORNERSTONE] has been selected for [MODE] in the [GEOMETRIC CORRECTION]:
 - Press the 3D REFORM button for 2 or more seconds.
 - Run [DISPLAY] → [GEOMETRIC CORRECTION] → [RESET] in the on-screen menu.
 - Using CORNERSTONE correction can cause the image to be slightly blurred because the correction is made electronically.
-

① Preventing the Unauthorized Use of the Projector [SECURITY]

A keyword can be set for your projector using the Menu to avoid operation by an unauthorized user. When a keyword is set, turning on the projector will display the Keyword input screen. Unless the correct keyword is entered, the projector cannot project an image.

- The [SECURITY] setting cannot be cancelled by using the [RESET] of the menu.

To enable the Security function:

1. Press the MENU button.

The menu will be displayed.

2. Press the ► button twice to select [SETUP] and press the ▼ button or the ENTER button to select [MENU(1)].

3. Press the ► button to select [CONTROL].

4. Press the ▼ button to select [SECURITY] and press the ENTER button.

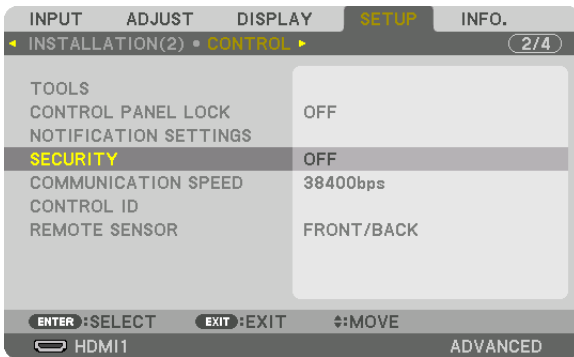

The OFF/ON menu will be displayed.

5. Press the ▼ button to select [ON] and press the ENTER button.



The [SECURITY KEYWORD] screen will be displayed.

6. Type in a combination of the four ▲▼◀▶ buttons and press the ENTER button.

NOTE: A keyword must be 4 to 10 digits in length.



The [CONFIRM KEYWORD] screen will be displayed.

NOTE: Make a note of your password and store it in a safe place.

7. Type in the same combination of ▲▼◀▶ buttons and press the ENTER button.

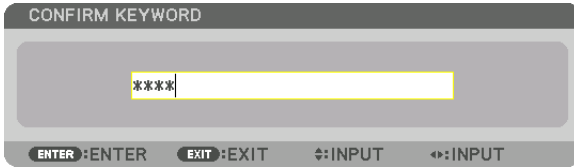

The confirmation screen will be displayed.

8. Select [YES] and press the ENTER button.



The SECURITY function has been enabled.

To power on the projector when [SECURITY] is enabled:

1. Press the  (POWER) button.

- If using the remote control, press the POWER ON button.

The projector will be turned on and display a message to the effect that the projector is locked.

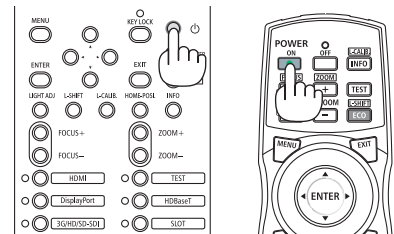

2. Press the MENU button.

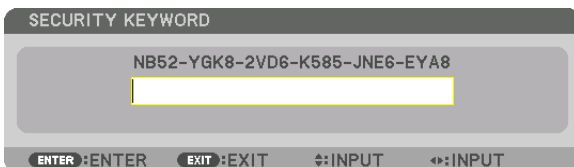

3. Type in the correct keyword and press the ENTER button. The projector will display an image.

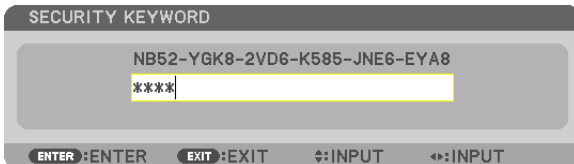

NOTE:

- The security disable mode is maintained until the main power is turned off or unplugging the power cable.

To disable the SECURITY function:

1. Press the MENU button.

The menu will be displayed.

2. Select [SETUP] → [CONTROL] → [SECURITY] and press the ENTER button.

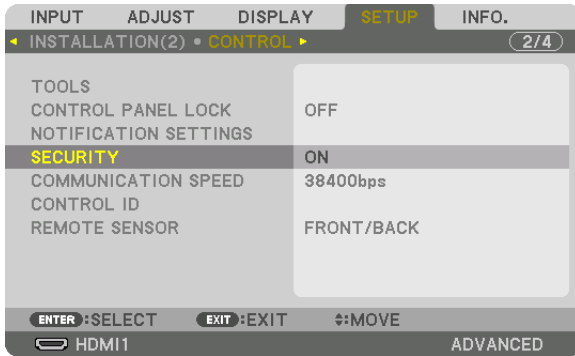

The OFF/ON menu will be displayed.

3. Select [OFF] and press the ENTER button.

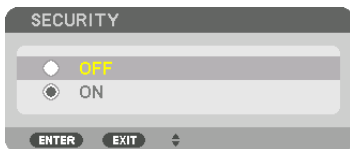

The SECURITY KEYWORD screen will be displayed.

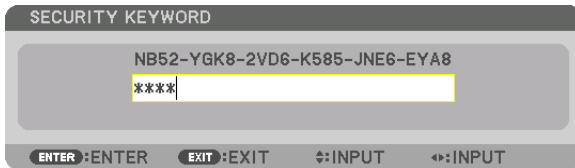

4. Type in your keyword and press the ENTER button.

When the correct keyword is entered, the SECURITY function will be disabled.

NOTE: If you forget your keyword, contact your distributor. Your distributor will provide you with your keyword in exchange for your request code. Your request code is displayed in the Keyword Confirmation screen. In this example [NB52-YGK8-2VD6-K585-JNE6-EYA8] is a request code.

12 Projecting 3D videos

The projector can connect a 3D image system to project 3D images.
The ports that support 3D image are DisplayPort1 IN, DisplayPort2 IN Terminals and HDBaseT Port.

CAUTION

Health precautions

Before use, please make sure to read any health precautions that may be stated in the operating manuals enclosed with the 3D eyewear and 3D video software (Blu-ray player, games, computer animation files, etc.).

Please take note of the following in order to avoid adverse health effects.

- Please do not use the 3D eyewear for purposes other than to watch 3D videos.
- Please keep a distance of at least 2 m away from the screen when watching videos. Watching a video too close to the screen will increase eye fatigue.
- Please do not watch videos continuously for a long period of time. Please take a 15 minutes' break after every hour of watching.
- Please consult a doctor before watching if you or any of your family members have a history of suffering from seizures caused by light sensitivity.
- Please stop watching immediately and take a rest when you feel physically unwell while watching (vomiting, giddiness, nausea, headaches, sore eyes, blurred vision, cramps and numbness in the limbs, etc.). Please consult a doctor if the symptoms persist.
- Please watch a 3D video directly in front of the screen. If you watch a 3D video obliquely from the sides, this may result in physical and eye fatigue.

Procedure to watch 3D videos using this projector

1. Connect a 3D image system to the projector.
2. Switch on the projector and the 3D image system.
3. Perform advanced settings for 3D.

Perform each advanced setting according to your 3D image system.

If you do this incorrectly, your 3D image will not be displayed correctly.

(1) Press the MENU button.

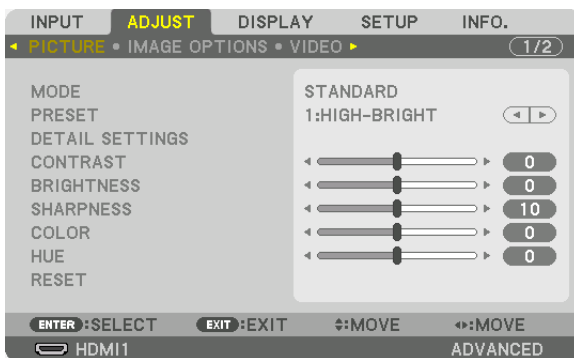

The MENU will be displayed.

(2) Press the ► button, select [ADJUST], then press ENTER.

[PICTURE] will be highlighted.

(3) Use the ► button to select [3D SETTINGS(1)].

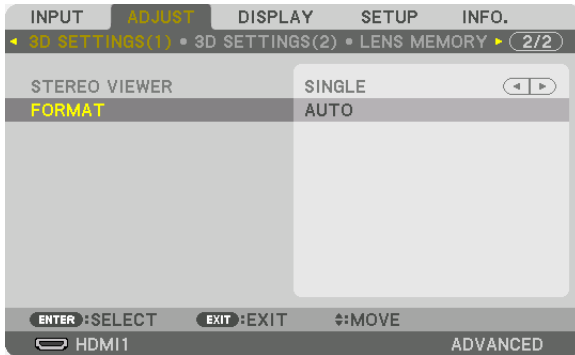

The [3D SETTINGS(1)] screen will be displayed.

(4) Press the ▼ button to select the menu and set each item. (→ page 94)

(5) Perform the same steps as (3) and (4) to set each item for [3D SETTINGS (2)]. (→ page 95)

Press the MENU button to return to the original screen.

- The 3D caution message screen will be displayed when switching to a 3D video (default factory setting when shipped). Please read the “Health Precautions” on the previous page to watch videos in the correct manner. The screen will disappear after 60 seconds or when the ENTER button is pressed. (→ page 108)

4. Play a 3D video and wear the 3D eyewear to watch the 3D video.

A normal video will be shown when a 2D video is input.

To watch a 3D video in 2D, select [OFF(2D)] in the [FORMAT] screen.

NOTE:

- Do not perform special features such as fast-forward, rewind, or pause during 3D viewing. If you do this, you may not play 3D video correctly. If this happens, set the item for [L/R OUTPUT REF. POLARITY] again.
 - Upon switching to 3D image, the following functions will be cancelled and disabled. [BLANKING], [PICTURE BY PICTURE], [GEOMETRIC CORRECTION], [EDGE BLENDING] ([GEOMETRIC CORRECTION] and [EDGE BLENDING] adjustment values will be maintained.)
 - The output may not automatically switch to a 3D video depending on the 3D input signal.
 - Check the operating conditions described in the user manual of the Blu-ray player.
 - The 3D eyewear allows videos to be viewed in 3D by receiving synchronized optical signals output from the 3D emitter. As a result, the 3D image quality may be affected by conditions such as the brightness of the surroundings, screen size, viewing distance, etc.
-

13 Controlling the Projector by Using an HTTP Browser

Overview

Using the web browser on the computer, the HTTP server screen of the projector can be displayed to operate the projector.

Possible operations on the HTTP server screen

- Configure the settings required for connecting the projector to the network (wired LAN). (NETWORK SETTINGS)
- Configure the email notification. (ALERT MAIL)
When the projector is connected to a network (wired LAN), notifications on various errors are sent to the email address that has been set up.
- Operate the projector.
Operations such power on/off of the projector, input terminal switchover, picture control, and lens control etc. can be carried out.
- Configure the [PJLink PASSWORD] and [AMX BEACON] etc.

For details about settings and adjustments, see the explanation on the screen menu.

To view the HTTP server screen

1. Connect the projector to the computer with a LAN cable sold commercially.

Connect the LAN cable to the LAN port or HDBaseT port of the projector. (→ page 10)

2. Select [SETUP] → [NETWORK SETTINGS] → [WIRED LAN] in the on-screen menu to configure the network settings. (→ page 122)

3. Start up the web browser on your computer and enter the address or URL in the input field.

Specify the address or URL as “http://<IP Address of Projector>/index.html”.

The basic HTTP server screen will be displayed.

TIP: The factory setting IP address is [DHCP ON].

NOTE:

- To use the projector in a network, consult with your network administrator about network settings.
 - The display's or button's response can be slowed down or operation may not be accepted depending the settings of your network. Should this happen, consult your network administrator. The projector may not respond if its buttons are repeatedly pressed in rapid intervals. Should this happen, wait a moment and repeat. If you still can't get any response, turn off and back on the projector.
 - If the PROJECTOR NETWORK SETTINGS screen does not appear in the web browser, press the Ctrl+F5 keys to refresh your web browser (or clear the cache).
 - This projector uses “JavaScript” and “Cookies” and the browser should be set to accept these functions. The setting method will vary depending on the version of browser. Please refer to the help files and the other information provided in your software.
-

Preparation before Use

Connect the projector to a commercially available LAN cable before engaging in browser operations. (→ page 10)
Operation with a browser that uses a proxy server may not be possible depending on the type of proxy server and the setting method. Although the type of proxy server will be a factor, it is possible that items that have actually been set will not be displayed depending on the effectiveness of the cache, and the contents set from the browser may not be reflected in operation. It is recommended that a proxy server not be used unless it is unavoidable.

Handling of the Address for Operation via a Browser

Regarding the actual address that is entered for the address or entered to the URL column when operation of the projector is via a browser, the host name can be used as it is when the host name corresponding to the IP address of the projector has been registered to the domain name server by a network administrator, or the host name corresponding to the IP address of the projector has been set in the "HOSTS" file of the computer being used.

Example 1: When the host name of the projector has been set to "pj.nec.co.jp", access is gained to the network setting by specifying
http://pj.nec.co.jp/index.html
for the address or the entry column of the URL.

Example 2: When the IP address of the projector is "192.168.73.1", access is gained to the network setting by specifying
http://192.168.73.1/index.html
for the address or the entry column of the URL.

14 Storing Changes for Lens Shift, Zoom, and Focus [LENS MEMORY]

This function serves to store the adjusted values when using the LENS SHIFT, ZOOM and FOCUS buttons of the projector. Adjusted values can be applied to the signal you selected. This will eliminate the need to adjust lens shift, focus, and zoom at the time of source selection. There are two ways to save adjusted values for lens shift, zoom, and focus.

Function name	Description	page
REF. LENS MEMORY	Adjusted values common to all input signals. At the time of installation, two kinds of adjusted values can be stored. If no adjusted values have been saved to [LENS MEMORY], the lens will apply [REF.LENS MEMORY] adjusted values.	→ page 113
LENS MEMORY	Adjusted values for each input signal. Use the adjusted values for the signal with a different aspect ratio or resolution. The adjusted values can be applied at the time of source selection.	→ page 96

NOTE:

- Be sure to carry out [LENS CALIBRATION] after installing the lens unit L4K-11ZM/L4K-15ZM/L4K-20ZM. If you need to replace the lens unit, contact your distributor and have them do it for you.

To store your adjusted values in [REF. LENS MEMORY]:

1. Press the **MENU** button.

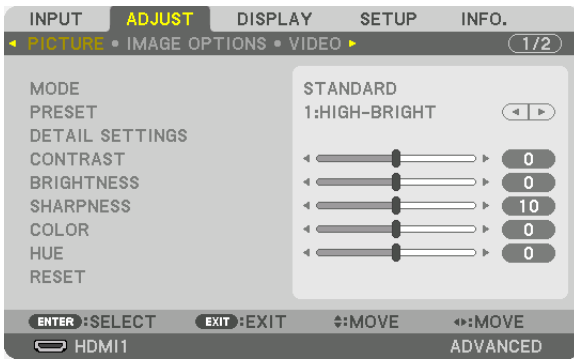

The menu will be displayed.

2. Press the **▶** button to select [SETUP] and press the **ENTER** button.



3. Press the **▶** button to select [INSTALLATION(2)].



4. Press the ▼ button to select [REF. LENS MEMORY] and press the ENTER button.

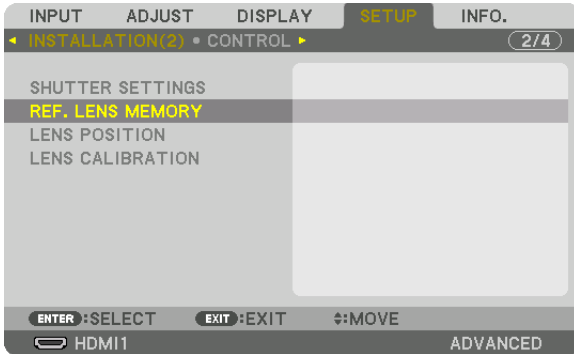

The [REF. LENS MEMORY] screen will be displayed.

5. Make sure [PROFILE] is highlighted, then press the ENTER button.



The [PROFILE] selection screen appears.

6. Press the ▼/▲ buttons to select the [PROFILE] number, then press the ENTER button.



Return to the [REF. LENS MEMORY] settings screen.

7. Select [STORE] and press the ENTER button.



The confirmation screen will be displayed.

8. Press the ◀ button to select and [YES] and press the ENTER button.

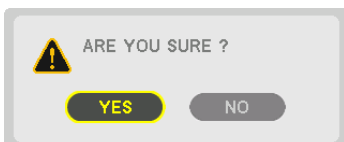

Select a [PROFILE] number and save the adjusted [LENS SHIFT], [ZOOM], and [FOCUS] values to it.

9. Press the MENU button.

The menu will be closed.

TIP:

- To store adjusted values for each input source, use the Lens Memory function. (→ page 96)

To call up your adjusted values from [REF. LENS MEMORY]:

1. Press the MENU button.

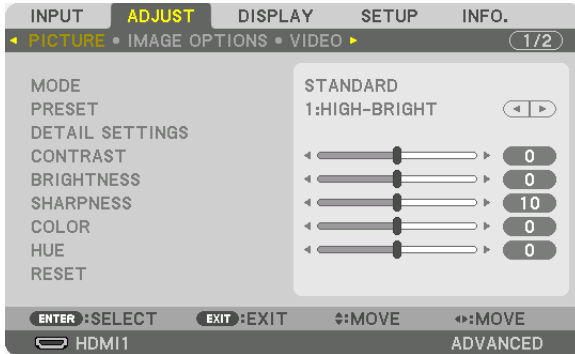

The menu will be displayed.

2. Press the ► button to select [SETUP] and press the ENTER button.



3. Press the ► button to select [INSTALLATION(2)].

4. Press the ▼ button to select [REF. LENS MEMORY] and press the ENTER button.

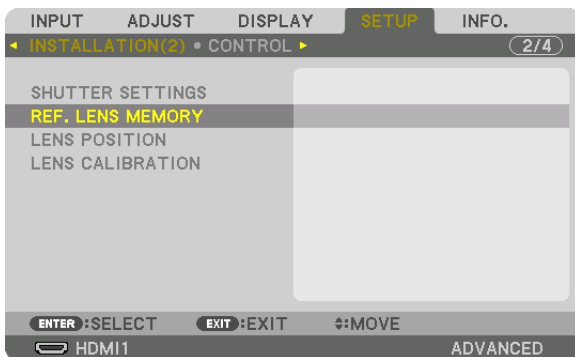

The [REF. LENS MEMORY] screen will be displayed.

5. Make sure [PROFILE] is highlighted, then press the ENTER button.

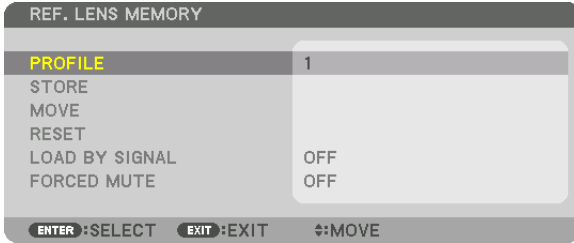

The [PROFILE] selection screen appears.

6. Press the ▼/▲ buttons to select the [PROFILE] number, then press the ENTER button.



Return to the [REF. LENS MEMORY] settings screen.

7. Select [MOVE] and press the ENTER button.



The lens will shift based on the adjusted values stored in the selected [PROFILE].

8. Press the ◀ button to select and [YES] and press the ENTER button.

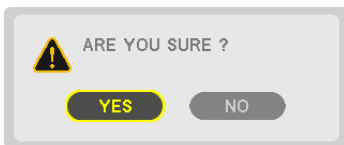

The adjusted values will be applied to the current signal. .

9. Press the MENU button.

The menu will be closed.

TIP:

To call up the stored values from [LENS MEMORY]:

1. From the menu, select [ADJUST] → [LENS MEMORY] → [MOVE] and press the ENTER button.



The confirmation screen will be displayed.

2. Press the ◀ button to select and [YES] and press the ENTER button.

During projection, if the adjusted values for an input signal have been saved, the lens will shift. If not, the lens will shift according to the adjusted values stored in the selected [REF. LENS MEMORY] [PROFILE] number.

To automatically apply the stored values at the time of source selection:

1. From the menu, select [SETUP] → [REF. LENS MEMORY] → [LOAD BY SIGNAL] and press the ENTER button.



2. Press the ▼ button to select and [ON] and press the ENTER button.

This will move the lens automatically to the position at the time of source selection according to the adjusted values.

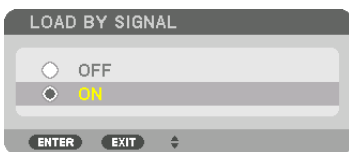

NOTE: The Lens Memory function may not produce a completely aligned image (due to tolerances in the lenses) using the adjusted values stored in the projector. After calling up and applying the stored values from the Lens Memory function, finely adjust the lens shift, zoom and focus to produce the best possible image.

4. Multi-Screen Projection

This projector can be used singly or arranged in multiple units for multi-screen projection.

① Things that can be done using multi-screen projection

Case 1

Using a single projector to project two or four types of videos at the same time [PICTURE BY PICTURE]

Connection example and projection image

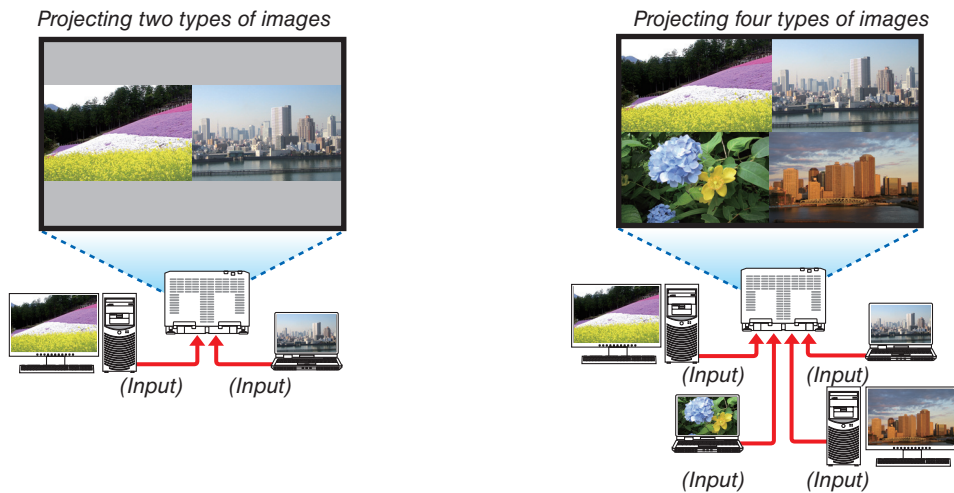

Case 2

Lien up multiple projectors to project a high-resolution image in a larger screen. [TILING]

Connection example and projection image

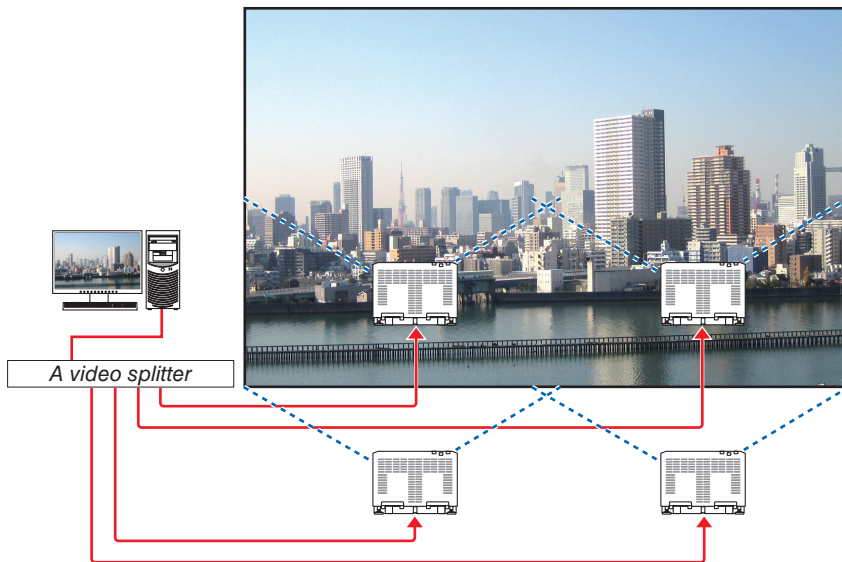

② Using a single projector to project two or four types of videos at the same time [PICTURE BY PICTURE]

The projection video in the first screen display is known as the MAIN display while the projection video that is called out subsequently is known as the SUB1, SUB2 and SUB3 display.

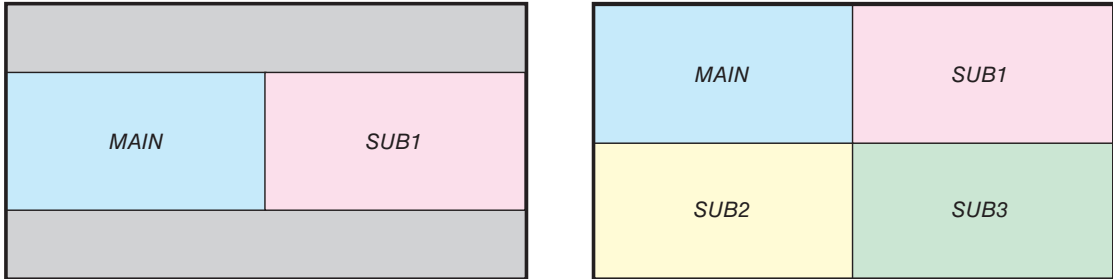

- The PICTURE BY PICTURE function supports the following input terminals and input signals.

Input terminals

Two screens: SDI1, SDI2, SDI3, SDI4, HDMI1, HDMI2, DisplayPort1, DisplayPort2, HDBaseT, SLOT
Four screens: SDI1, SDI2, SDI3, SDI4, HDMI1, HDMI2, DisplayPort1, DisplayPort2

Input signals

Two screens: up to 4K 30Hz
Four screens: up to 1920x1080 60Hz/50Hz

Projecting four screens

This section provides procedures for projecting four types of images at the same time.

Preparation:

Connect the projector to devices that output four types of images and turn on the power of all the devices.

1. Press the MENU button to display the on-screen menu and select [DISPLAY] → [PICTURE BY PICTURE].

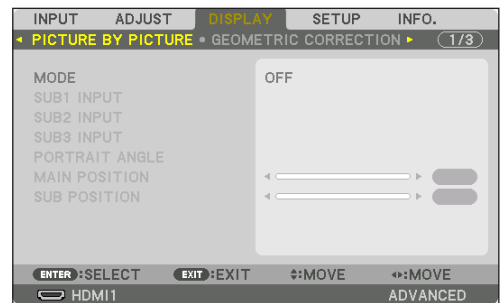

2. Select [MODE] using the ▼/▲ buttons, and press the ENTER button.

This displays the [MODE] screen.

3. Select [QUAD] using the ▼/▲ buttons, and press the ENTER button.

The display returns to the PICTURE BY PICTURE screen.

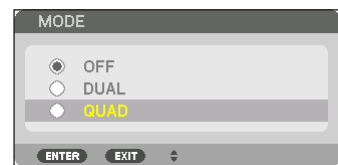

4. Select [SUB1 INPUT] using the ▼/▲ buttons, and press the ENTER button.

This displays the [SUB1 INPUT] screen.

5. Select an input signal for SUB 1 using the ▼/▲ buttons and press the ENTER button.

The display returns to the PICTURE BY PICTURE screen.

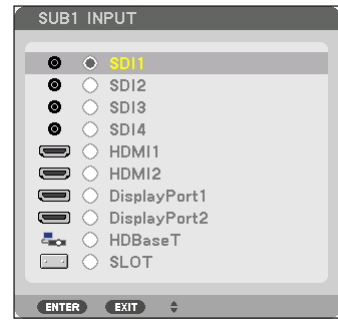

6. Perform the same steps as 4 and 5 to select input signals for SUB2 and SUB3.

7. Press the MENU button.

The on-screen menu will disappear.

- To return to a single screen, select [OFF] from the MODE select screen in Step 3.

TIP:

- To project two screens, select [DUAL] in the step 3, and select the input signal for SUB1 in the steps 4 and 5.
- In the case of projecting two screens, you can set the orientation of screen to the portrait position or adjust the display position. (→ page 98, 99)

Restrictions

- The following operations are enabled only for the main display.
 - Visual adjustments
 - TEST PATTERN
- The following operations are enabled for MAIN, SUB1, SUB2, and SUB3. These operations cannot be applied individually.
 - Momentary deletion of video (AV Mute)
 - Video pause (Freeze)
- [PICTURE BY PICTURE] cannot be used when a 3D video is being displayed.
- The following operations cannot be made when [PICTURE BY PICTURE] is used.
 - Video magnification / demagnification using the partial D-ZOOM/ZOOM +/- buttons.
 - DYNAMIC CONTRAST

③ Line up multiple projectors to display a high resolution image in a larger screen [TILING]

This section provides procedures for projecting an image with a resolution of 4096 x 2160 (4K) by using four projectors.

Preparation:

- Arrange four projectors in a 2 × 2 layout.
- Connect your video output equipment to the four projectors via a video splitter.
- Turn on the power of all devices to project the same four images

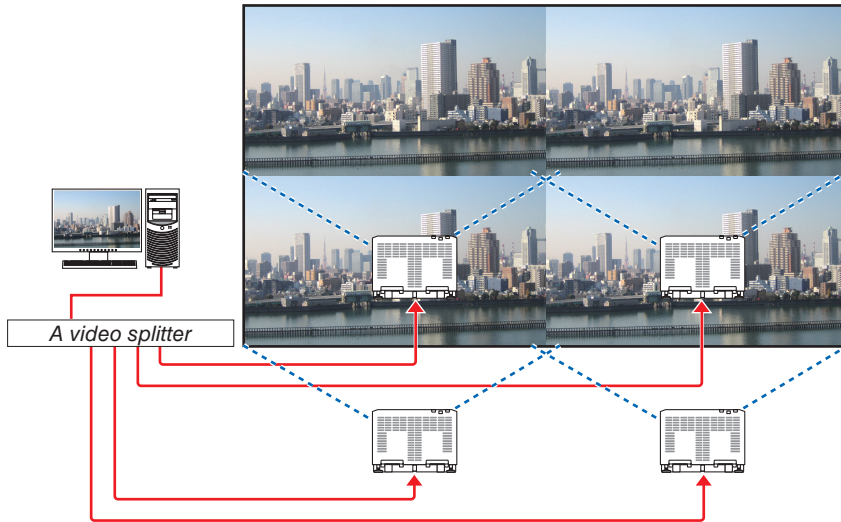

When performing settings or adjustments using one remote control, enable the [CONTROL ID] for assigning ID to each projector so as not to activate the other projectors. (→ page 120)

Things to note when installing projectors

- Leave sufficient space on the left and right of the projector so that the intake and exhaust vents of the projector are not obstructed. When the intake and exhaust vents are obstructed, the temperature inside the projector will rise and this may result in a malfunction.

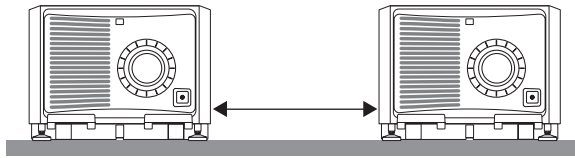

- Please do not pile up the projectors directly on top of one another when installing them. When the projectors are piled up on top of one another, they may fall down, resulting in damage and failure. The following installation is recommended when combining the installation of two projectors. Please leave sufficient space on the left and right of the projector.

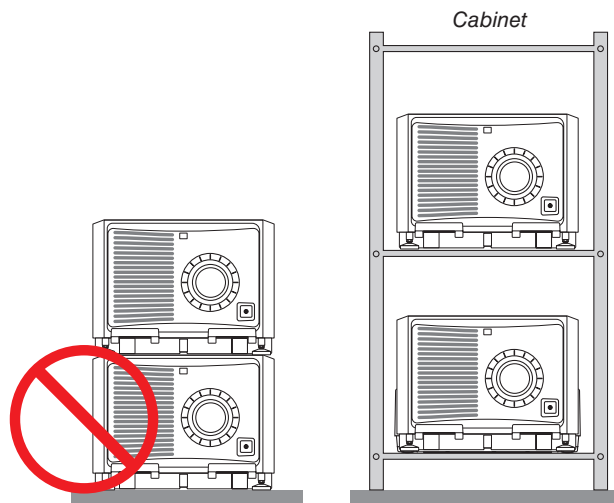

WARNING

Please request the retail store for special installation services such as when mounting the projector to the ceiling or suspending from the ceiling using eye bolts. Never carry out the installation by yourself. The projector may fall down and result in injury. Please use a sturdy cabinet that can withstand the weight of the projector for the installation. Please do not pile up the projectors directly on top of one another.

NOTE:

- For the range of the projection distance, please refer to the Appendix "Throw distance and screen size". (→ page 143)

Setting TILING

1. Press the **MENU** button to display the on-screen menu and select **[DISPLAY]** → **[PICTURE SETTING]** → **[MODE]**.

This displays the **[MODE]** screen.

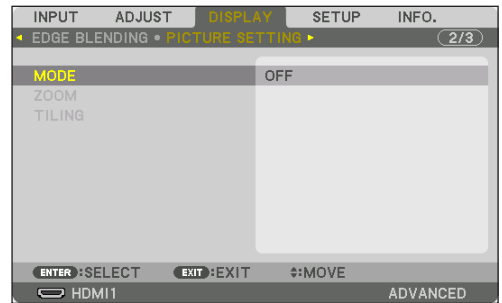

2. Select **[TILING]** using the **▼/▲** buttons, and press the **ENTER** button.

The display returns to the **PICTURE SETTING** screen.

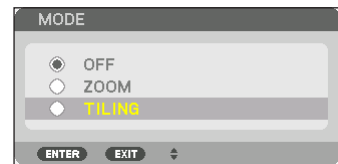

3. Select **[TILING]** using the **▼/▲** buttons, and press the **ENTER** button.

This displays the **[TILING]** screen.

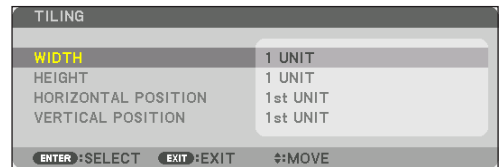

4. Set **[WIDTH]**, **[HEIGHT]**, **[HORIZONTAL POSITION]**, and **[VERTICAL POSITION]**

- (1) In the screen for setting the number of horizontal units, select **[2 UNITS]**. (number of units in the horizontal direction)
- (2) In the screen for setting the number of vertical units, select **[2 UNITS]**. (number of units in the vertical direction)
- (3) In the screen for setting the horizontal order, select **[1st UNIT]** or **[2nd UNIT]**.
(look at the screens, the one on the left is the **[1st UNIT]** while the one on the right is the **[2nd UNIT]**)
- (4) In the screen for setting the vertical order, select the **[1st UNIT]** or the **[2nd UNIT]**.
(look at the screens, the one at the top is the **[1st UNIT]** while the one at the bottom is the **[2nd UNIT]**)

4. Multi-Screen Projection

After completing setting for the steps 1 to 4, a single image will be displayed to fill the screen.



5. Press the MENU button.

The on-screen menu will disappear.

6. Adjust the lens shift of each projector to fine-tune the boundaries of the screen.

To make boundaries less noticeable of a projected image, use [EDGE BLENDING] to adjust them. (→ [next page](#))

④ Adjust boundaries of a projected image [EDGE BLENDING]

This projector is equipped with an “EDGE BLENDING Function” that makes the edges (boundaries) of the projection screen indistinguishable.

NOTE:

- Before performing the Edge Blending function, place the projector in the correct position so that the image becomes square in the appropriate size, and then make optical adjustments (lens shift, focus, and zoom).
- Adjust the brightness of each projector using [REF. LIGHT ADJUST] under [LIGHT MODE]. In addition, use [REF. WHITE BALANCE] to adjust the [CONTRAST], [BRIGHTNESS] and [UNIFORMITY].

The following procedure shows an example of four projectors in a 2×2 layout.

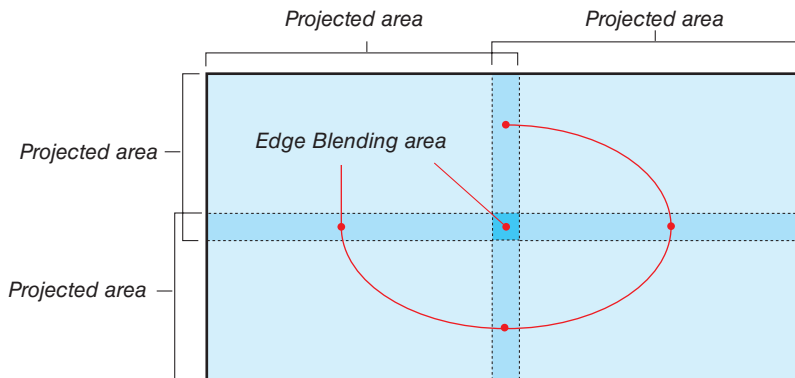

Setting the overlap of projection screens

① Enable [EDGE BLENDING].

1. Press the MENU button.

The menu will be displayed.

2. Select [DISPLAY] → [EDGE BLENDING].

The [EDGE BLENDING] screen will be displayed. Align the cursor with [MODE] and then press the ENTER button. The mode screen will be displayed.



3. Select [MODE] → [ON] and press the ENTER button.

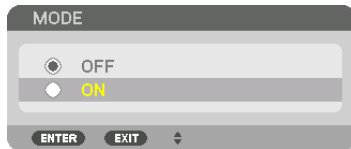

This enables the Edge Blending function. The following menu items are available:

[MARKER], [TOP], [BOTTOM], [LEFT], [RIGHT], [BLEND CURVE], and [BLACK LEVEL]

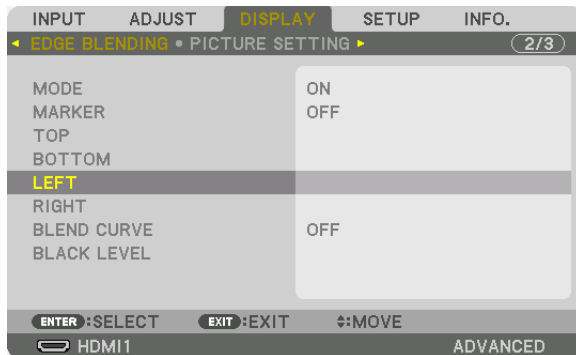

4. Multi-Screen Projection

4. Select an appropriate item from [TOP], [BOTTOM], [LEFT], and [RIGHT] for an area of overlapped edges, and turn on [CONTROL].

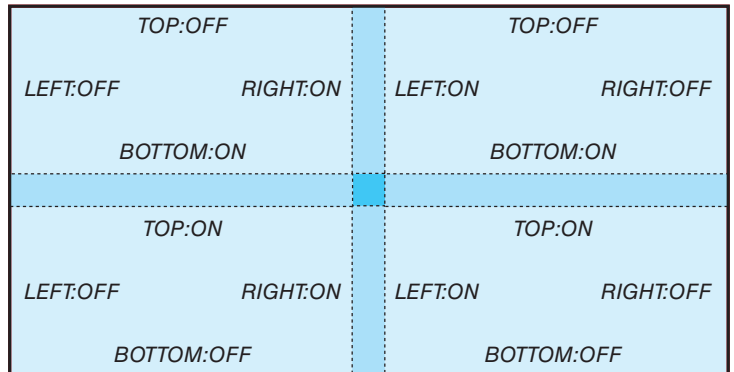
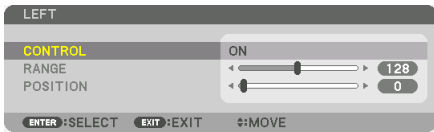

② Adjust [RANGE] and [POSITION] to determine an area of overlapped edges of images projected from each projector.

Turning on [MARKER] will display markers in magenta and green.
The magenta marker is used for [RANGE] and green one for [POSITION].

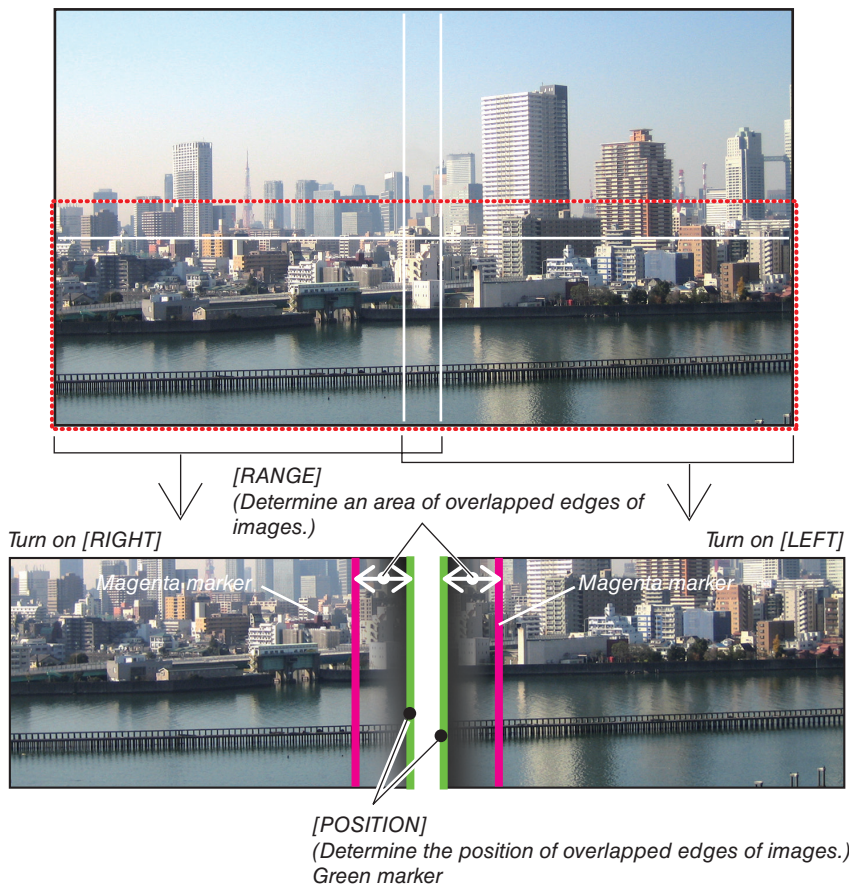

* The 2 screens are separated in the diagram for explanatory purposes.

1 Adjust [RANGE].

Use the ◀ or ▶ button to adjust the overlapped area.

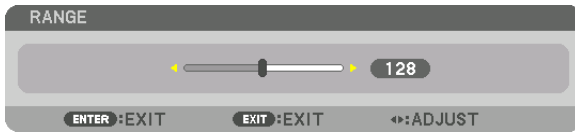

TIP:

- Adjust to overlap one projector's marker with the other projector's marker.

2 Adjust [POSITION].

Use the ◀ or ▶ button to align one edge with the other edge of overlapped images.

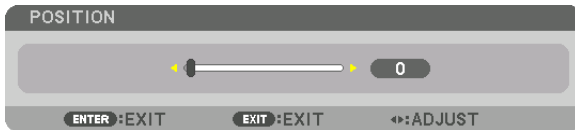

TIP:

- When displaying a signal with a different resolution, perform the Edge Blending function from the start.
- Setting of [MARKER] will not be saved and return to [OFF] when the projector is turned off.
- To display or hide the marker while the projector is running, turn on or off [MARKER] from the menu.

[BLEND CURVE]

Adjust the brightness of the overlapped section on the screens. According to the necessity, adjust the brightness of the overlapped section on the screens by the [BLEND CURVE] AND [BLACK LEVEL].

- Set the [MODE] to [ON] for selecting [BLEND CURVE] and [BLACK LEVEL].

Selecting an option for the [BLEND CURVE]

By controlling the graduation of the overlapped section on the screens, it makes the border on the projected screens inconspicuous. Select the optimal option among nine.

1. On the On-Screen Menu, move the cursor onto the [DISPLAY] → [EDGE BLENDING] → [BLEND CURVE] and then press the ENTER. The option setting screen for the [BLEND CURVE] is displayed on.



2. Select one option among nine by ▲ or ▼.

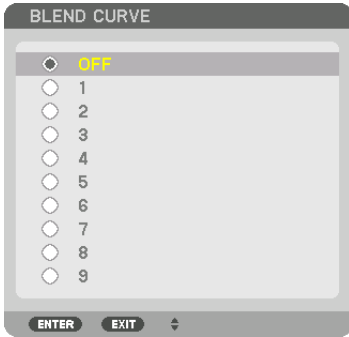

Black Level Adjustment

This adjusts the black level of the overlapping area and the non-overlapping area of the multi-screen (EDGE BLENDING). Adjust the brightness level if you feel the difference is too large.

NOTE:

Adjustable area varies depending on what combination of [TOP], [BOTTOM], [LEFT] and [RIGHT] are turned on.

The black level of the lower left projector is adjusted as shown in the figure.

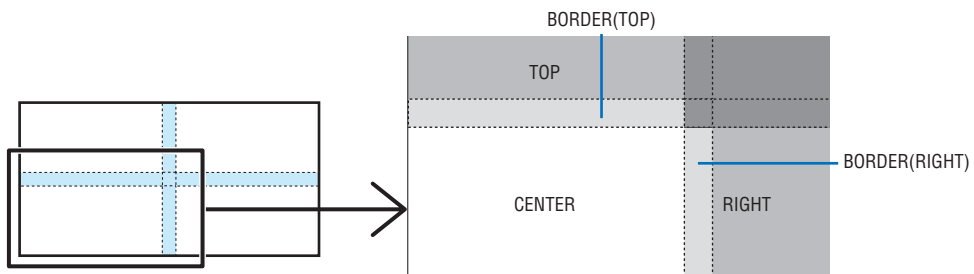

1. Select [DISPLAY] → [EDGE BLENDING] → [BLACK LEVEL] and press the ENTER button.

The screen will switch to the black level adjustment screen.



2. Use the ◀, ▶, ▼ or ▲ button to select an item and use the ◀ or ▶ to adjust the black level.

Do this for the other projector if necessary.

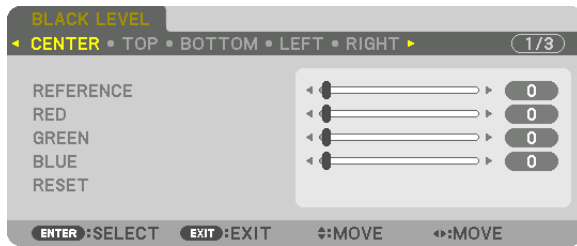

TIP:

9-segmented portions for Black Level adjustment

The black level of the center projector is adjusted as shown in the figure.

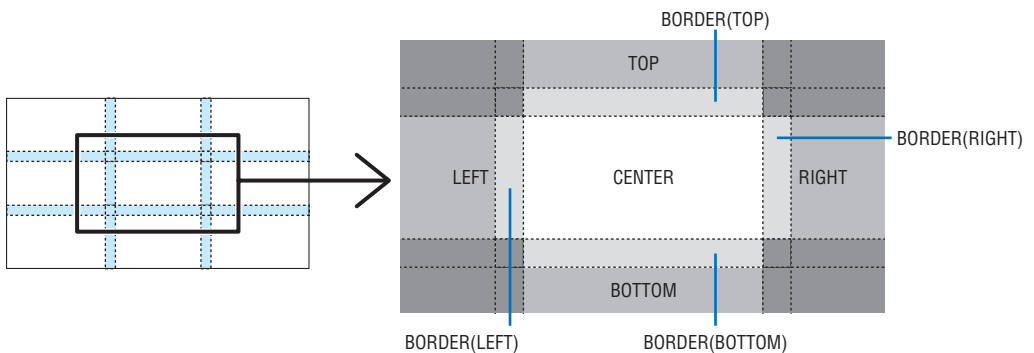

TIP:

- The number of black level division screens changes depending on the number of edge blending positions selected (top, bottom, right, left). In addition, when the top / bottom and left / right ends are selected, the corner division screen appears.
- The edge blending width is the width set in the range and the corner is formed by the intersecting area of the top / bottom ends or left / right ends.
- The [BLACK LEVEL] can be adjusted to make it brighter only.

5. Using On-Screen Menu

① Using the Menus

NOTE: The on-screen menu may not be displayed correctly while interlaced motion video image is projected.

1. Press the **MENU** button on the remote control or the projector cabinet to display the menu.

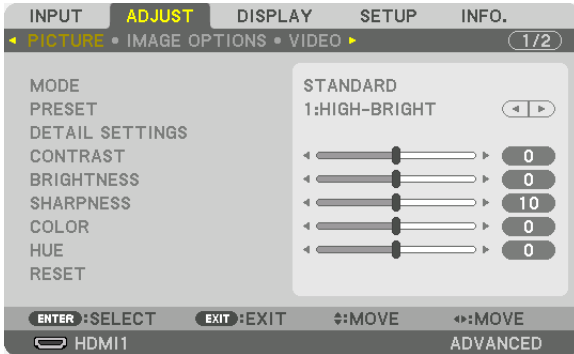

NOTE: The commands such as ENTER, EXIT, ▲▼, ◀▶ in the bottom show available buttons for your operation.

2. Press the ◀▶ buttons on the remote control or the projector cabinet to display the submenu.
3. Press the ENTER button on the remote control or the projector cabinet to highlight the top item or the first tab.
4. Use the ▲▼ buttons on the remote control or the projector cabinet to select the item you want to adjust or set.
You can use the ◀▶ buttons on the remote control or the projector cabinet to select the tab you want.
5. Press the ENTER button on the remote control or the projector cabinet to display the submenu window.
6. Adjust the level or turn the selected item on or off by using the ▲▼◀▶ buttons on the remote control or the projector cabinet.
Changes are stored until adjusted again.
7. Repeat steps 2-6 to adjust an additional item, or press the EXIT button on the remote control or the projector cabinet to quit the menu display.

NOTE: When a menu or message is displayed, several lines of information may be lost, depending on the signal or settings.

8. Press the **MENU** button to close the menu.
To return to the previous menu, press the **EXIT** button.

2 Menu Elements

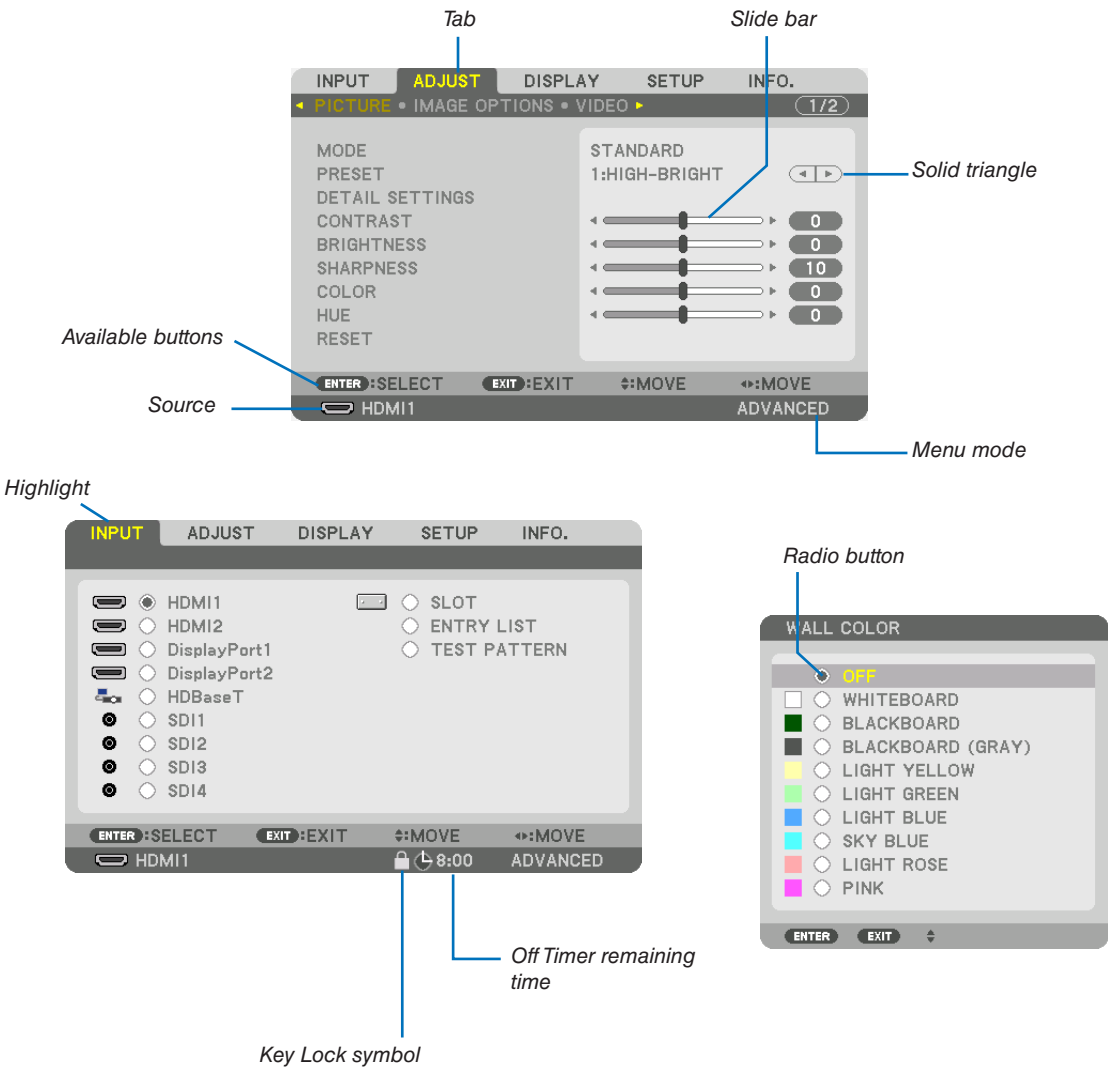

Menu windows or dialog boxes typically have the following elements:

- Highlight.....Indicates the selected menu or item.
- Solid triangleIndicates further choices are available. A highlighted triangle indicates the item is active.
- Tab.....Indicates a group of features in a dialog box. Selecting on any tab brings its page to the front.
- Radio button.....Use this round button to select an option in a dialog box.
- SourceIndicates the currently selected source.
- Menu modeIndicates the current menu mode: BASIC or ADVANCED.
- Off Timer remaining time....Indicates the remaining countdown time when the [OFF TIMER] is preset.
- Slide barIndicates settings or the direction of adjustment.
- Key Lock symbolIndicates the [CONTROL PANEL LOCK] is enabled.

3 List of Menu Items

• Basic menu items are indicated by shaded area.

Some menu items are not available depending on the input source.

Menu Item	Default	Options		
INPUT	HDMI1			
	HDMI2			
	DisplayPort1			
	DisplayPort2			
	HDBaseT			
	SDI1			
	SDI2			
	SDI3			
	SDI4			
	SLOT			
	ENTRY LIST			
TEST PATTERN				
ADJUST	MODE	STANDARD	STANDARD, PROFESSIONAL	
	PRESET	*	AUTO, 1:HIGH-BRIGHT, 2:PRESENTATION, 3:REC709, 4:CINEMA, 5:REC2020, 6:sRGB, 7:DICOM SIM.	
	DETAIL SETTINGS	GENERAL		
		REFERENCE	*	HIGH-BRIGHT, PRESENTATION, REC709, CINEMA, REC2020, sRGB, DICOM SIM.
		GAMMA SETTING*1		
		SCREEN SIZE*2	*	LARGE, MEDIUM, SMALL
		COLOR TEMPERATURE*3	*	
		DYNAMIC CONTRAST	*	OFF, MOTION IMAGE, STILL IMAGE
		LIGHT MODE		
		LIGHT ADJUST		
		CONSTANT BRIGHTNESS	OFF	OFF, ON
		WHITE BALANCE		
		CONTRAST R	0	
		CONTRAST G	0	
		CONTRAST B	0	
		BRIGHTNESS R	0	
		BRIGHTNESS G	0	
		BRIGHTNESS B	0	
		COLOR CORRECTION		
		RED	0	HUE, SATURATION
		GREEN	0	HUE, SATURATION
		BLUE	0	HUE, SATURATION
	YELLOW	0	HUE, SATURATION	
	MAGENTA	0	HUE, SATURATION	
	CYAN	0	HUE, SATURATION	
	COLOR SETTING			
	SETTINGS		ON, OFF	
	MCGD		REFERENCE, RED, GREEN, BLUE, WHITE, OK, CHANCEL	
	TCGD		REFERENCE, RED, GREEN, BLUE, CYAN, MAGENTA, YELLOW, WHITE, SAVE, OK, CHANCEL	
	CONTRAST	50		
	BRIGHTNESS	50		
	SHARPNESS	10		
	COLOR	50		
	HUE	0		
	RESET			
	IMAGE OPTIONS	HORIZONTAL	*	
		VERTICAL	*	
		BLANKING	*	TOP, BOTTOM, LEFT, RIGHT
		OVERSCAN		AUTO, 0[%], 5[%], 10[%]
		ASPECT RATIO	AUTO	(HDTV/SDTV) AUTO, NORMAL, 4:3, LETTERBOX, WIDE SCREEN, ZOOM, FULL
	VIDEO	NOISE REDUCTION	OFF	OFF, LOW, MEDIUM, HIGH
DEINTERLACE		NORMAL	NORMAL, MOVIE, STILL	
CONTRAST ENHANCEMENT		MODE	AUTO	OFF, AUTO, NORMAL
SIGNAL TYPE		GAIN	AUTO	AUTO, RGB, REC601, REC709, REC2020
VIDEO LEVEL			AUTO	AUTO, NORMAL, ENHANCED, SUPER WHITE
HDR MODE			AUTO	AUTO, OFF, ON

* The asterisk (*) indicates that the default setting varies depending on the signal.

*1 The [GAMMA SETTING] item is available when an item other than [DICOM SIM.] is selected for [REFERENCE].

*2 The [SCREEN SIZE] item is available when [DICOM SIM.] is selected for [REFERENCE].

*3 When [HIGH-BRIGHT] or [PRESENTATION] is selected in [REFERENCE], the [COLOR TEMPERATURE] is not available.

5. Using On-Screen Menu

Menu Item		Default	Options	
ADJUST	3D SETTINGS(1)	STEREO VIEWER	SINGLE	
		FORMAT	AUTO	
	3D SETTINGS(2)	3D DETAIL SETTINGS	OFF	OFF, ON
		L/R DISPLAY REF.	NOT USE	NOT USED, USE GPI(TRUE), USE GPI(INVERT)
		DELAY		
		TIME		
		PHASE		
		FRAME RATE RATIO	1:1	1 : 1, 4 : 1, 6 : 1, 2 : 2, 4 : 2, 6 : 2
		INPUT FRAME DOMINANCE	LEFT(L1R1 L2R2)	LEFT(L1R1 L2R2), RIGHT(R1L1 R2L2)
	L/R OUTPUT REF. POLARITY	TRUE	TRUE, INVERT	
	DARK TIME			
	L/R INPUT REF.	USE PORT(TURE)	NONE PROVIDED, USE GPI(TRUE), USE GPI(INVERT), USE PORT(TURE), USE PORT(INVERT)	
	LENS MEMORY	STORE		
		MOVE		
		RESET		
LOAD BY SIGNAL		OFF	OFF, ON	
FORCED MUTE		OFF	OFF, ON	
DISPLAY	PICTURE BY PICTURE	MODE	OFF	
		SUB1 INPUT	SDI1, SDI2, SDI3, SDI4, HDMI1, HDMI2, DisplayPort1, DisplayPort2, HDBaseT, SLOT	
		SUB2 INPUT	SDI1, SDI2, SDI3, SDI4, HDMI1, HDMI2, DisplayPort1, DisplayPort2	
		SUB3 INPUT	SDI1, SDI2, SDI3, SDI4, HDMI1, HDMI2, DisplayPort1, DisplayPort2	
		PORTRAIT ANGLE	0°	0°, 90°, 270°
		MAIN POSITION		
	GEOMETRIC CORRECTION	MODE	OFF	OFF, KEYSTONE, CORNERSTONE, HORIZONTAL CORNER, VERTICAL CORNER, WARP, PC TOOL
		KEYSTONE	HORIZONTAL	
			VERTICAL	
			TILT	
			THROW RATIO	
		CORNERSTONE		TOP-LEFT, TOP, TOP-RIGHT, LEFT, RIGHT, BOTTOM-LEFT, BOTTOM, BOTTOM-RIGHT
		HORIZONTAL CORNER		TOP-LEFT, TOP, TOP-RIGHT, LEFT, RIGHT, BOTTOM-LEFT, BOTTOM, BOTTOM-RIGHT
		VERTICAL CORNER		TOP-LEFT, TOP, TOP-RIGHT, LEFT, RIGHT, BOTTOM-LEFT, BOTTOM, BOTTOM-RIGHT
		WARP		TOP-LEFT, TOP, TOP-RIGHT, LEFT, RIGHT, BOTTOM-LEFT, BOTTOM, BOTTOM-RIGHT
PC TOOL		OFF	OFF, 1, 2, 3	
RESET				
EDGE BLENDING	MODE	OFF	OFF, ON	
	MARKER	OFF	OFF, ON	
	TOP	CONTROL	OFF	OFF, ON
		RANGE		
		POSITION		
	BOTTOM	CONTROL	OFF	OFF, ON
		RANGE		
		POSITION		
	LEFT	CONTROL	OFF	OFF, ON
		RANGE		
		POSITION		
	RIGHT	CONTROL	OFF	OFF, ON
		RANGE		
		POSITION		
BLEND CURVE	5	OFF, 1, 2, 3, 4, 5, 6, 7, 8, 9		
BLACK LEVEL	CENTER		REFERENCE, RED, GREEN, BLUE, RESET	
	TOP			
	BOTTOM			
	LEFT			
	RIGHT			
	BORDER(TOP)			
	BORDER(BOTTOM)			
	BORDER(LEFT)			
BORDER(RIGHT)				

5. Using On-Screen Menu

Menu Item		Default	Options		
DISPLAY	PICTURE SETTING	MODE	OFF	OFF, ZOOM	
		ZOOM	HORIZONTAL ZOOM		
			VERTICAL ZOOM		
			HORIZONTAL POSITION		
			VERTICAL POSITION		
		TILING	WIDTH		
			HEIGHT		
			HORIZONTAL POSITION		
	VERTICAL POSITION				
	MULTI SCREEN	WHITE BALANCE	MODE		
			CONTRAST W		
			CONTRAST R		
			CONTRAST G		
			CONTRAST B		
BRIGHTNESS W					
BRIGHTNESS R					
BRIGHTNESS G					
BRIGHTNESS B					
SETUP	MENU(1)	LANGUAGE	ENGLISH	ENGLISH, DEUTSCH, FRANÇAIS, ITALIANO, ESPAÑOL, SVENSKA, 日本語 DANSK, PORTUGUÊS, ČEŠTINA, MAGYAR, POLSKI, NEDERLANDS, SUOMI NORSK, TÜRKÇE, РУССКИЙ, عربي, Ελληνικά, 简体中文, 한국어 ROMÂNĂ, HRVATSKA, БЪЛГАРСКИ, INDONESIA, हिन्दी, ไทย, ភ្នំខ្មែរ, 繁體中文, Tiếng Việt	
		COLOR SELECT	COLOR	COLOR, MONOCHROME	
		INPUT DISPLAY	ON	OFF, ON	
		MESSAGE DISPLAY	ON	OFF, ON	
		ID DISPLAY	OFF	OFF, ON	
		3D CAUTION MESSAGE	ON	OFF, ON	
		DISPLAY TIME	AUTO 45 SEC	MANUAL, AUTO 5 SEC, AUTO 15 SEC, AUTO 45 SEC	
	FILTER MESSAGE	OFF	OFF, 100[H], 500[H], 1000[H], 2000[H], 5000[H], 10000[H], 20000[H]		
	MENU(2)	MENU ANGLE	0°	0°, 90°, 270°	
		MENU POSITION	CENTER	TOP-LEFT, TOP-CENTER, TOP-RIGHT, CENTER-LEFT, CENTER, CENTER-RIGHT, BOTTOM-LEFT, BOTTOM-CENTER, BOTTOM-RIGHT	
	INSTALLATION(1)	ORIENTATION	DESKTOP FRONT	DESKTOP FRONT, CEILING REAR, DESKTOP REAR, CEILING FRONT	
		SCREEN TYPE	FREE	FREE, 4:3 SCREEN, 16:9 SCREEN, 16:10 SCREEN	
		WALL COLOR	OFF	OFF, WHITEBOARD, BLACKBOARD, BLACKBOARD (GRAY), LIGHT YELLOW, LIGHT GREEN, LIGHT BLUE, SKY BLUE, LIGHT ROSE, PINK	
		FAN MODE	AUTO	AUTO, HIGH, LOW	
		REF. LIGHT MODE	REF. LIGHT ADJUST		
			CONSTANT BRIGHTNESS	OFF	OFF, ON
		REF. WHITE BALANCE	CONTRAST R		
			CONTRAST G		
			CONTRAST B		
			BRIGHTNESS R		
			BRIGHTNESS G		
			BRIGHTNESS B		
		STATIC CONVERGENCE	UNIFORMITY R		
	UNIFORMITY B				
	HORIZONTAL R				
	HORIZONTAL G				
	HORIZONTAL B				
VERTICAL R					
VERTICAL G					
VERTICAL B					
INSTALLATION(2)	SHUTTER SETTINGS	POWER ON SHUTTER	OPEN	OPEN, CLOSE	
		PICTURE MUTE SHUTTER	OPEN	OPEN, CLOSE	
		FADE IN TIME		0-10 SEC	
		FADE OUT TIME		0-10 SEC	
	REF. LENS MEMORY	PROFILE	1	1, 2	
		STORE			
		MOVE			
		RESET			
		LOAD BY SIGNAL	OFF	OFF, ON	
		FORCED MUTE	OFF	OFF, ON	
LENS POSITION	HOME				
LENS CALIBRATION					

5. Using On-Screen Menu

Menu Item				Default	Options			
SETUP	CONTROL	TOOLS	ADMINISTRATOR MODE	MENU MODE	ADVANCED	ADVANCED, BASIC		
			NOT SAVE SETTING VALUES	OFF	OFF, ON			
			NEW PASSWORD					
			CONFIRM PASSWORD					
			PROGRAM TIMER	SETTINGS	EDIT	ENABLE	OFF	OFF, ON
						ACTIVE	OFF	OFF, ON
						DAY	SUN	SUN, MON, TUE, WED, THU, FRI, SAT, MON-FRI, MON-SAT, EVERY DAY
						TIME		
						FUNCTION	POWER	POWER, INPUT
						ADVANCED SETTINGS		
						POWER	OFF	OFF, ON
						INPUT	HDMI1	HDMI1, HDMI2, DisplayPort1, DisplayPort2, HDBaseT, SDI1, SDI2, SDI3, SDI4, SLOT
						REPEAT	OFF	OFF, ON
						DELETE		
						UP		
						DOWN		
						BACK		
			DATE AND TIME SETTINGS	TIME ZONE SETTINGS	UTC		-12:00, -11:30, -11:00, -10:30, -10:00, -09:30, -09:00, -08:30, -08:00, -07:30, -07:00, -06:30, -06:00, -05:30, -05:00, -04:30, -04:00, -03:30, -03:00, -02:30, -02:00, -01:30, -01:00, -00:30, 00:00, +00:30, +01:00, +01:30, +02:00, +02:30, +03:00, +03:30, +04:00, +04:30, +05:00, +05:30, +06:00, +06:30, +07:00, +07:30, +08:00, +08:30, +09:00, +09:30, +10:00, +10:30, +11:00, +11:30, +12:00, +12:30, +13:00	
				DATE AND TIME SETTINGS	DATE MM/DD/YYYY			
					TIME HH:MM			
					INTERNET TIME SERVER		OFF, ON	
					IP ADDRESS UPDATE			
				SUMMER TIME SETTINGS	ENABLE		OFF, ON	
					MON(START)		1, 2, 3, 4, 5, 6, 7, 8, 9, 10, 11, 12	
					DAY(START)		FIRST WEEK, SECOND WEEK, THIRD WEEK, FOURTH WEEK, LAST WEEK	
							SUN, MON, TUE, WED, THU, FRI, SAT	
					TIME(START)			
					MON(EXIT)		1, 2, 3, 4, 5, 6, 7, 8, 9, 10, 11, 12	
					DAY(EXIT)		FIRST WEEK, SECOND WEEK, THIRD WEEK, FOURTH WEEK, LAST WEEK	
				SUN, MON, TUE, WED, THU, FRI, SAT				
			TIME(EXIT)					
			TIME DIFFERENCE		+01:00, +00:30, -00:30, -01:00			
			CONTROL PANEL LOCK			OFF	OFF, ON	
			NOTIFICATION SETTINGS	REAR LED		ON	OFF, ON	
				BUZZER		ON	OFF, ON	
			SECURITY			OFF	OFF, ON	
			COMMUNICATION SPEED			38400bps	4800bps, 9600bps, 19200bps, 38400bps, 115200bps	
			CONTROL ID	CONTROL ID NUMBER		1	1-254	
				CONTROL ID		OFF	OFF, ON	
			REMOTE SENSOR			FRONT/BACK	FRONT/BACK, FRONT, BACK, HDBaseT	

5. Using On-Screen Menu

Menu Item		Default	Options			
SETUP	NETWORK SETTINGS	WIRED LAN	INTERFACE	LAN, HDBaseT		
			PROFILES	PROFILE 1, PROFILE 2		
			DHCP	OFF, ON		
			IP ADDRESS			
			SUBNET MASK			
			GATEWAY			
			AUTO DNS	OFF, ON		
			DNS CONFIGURATION			
		RECONNECT				
		PROJECTOR NAME	PROJECTOR NAME	PJ-*****		
		DOMAIN	HOST NAME	pj-*****		
			DOMAIN NAME			
		ALERT MAIL	ALERT MAIL	OFF, ON		
			HOST NAME	pj-*****		
			DOMAIN NAME			
			SENDER'S ADDRESS			
			SMTP SERVER NAME			
			RECIPIENT'S ADDRESS 1			
			RECIPIENT'S ADDRESS 2			
			RECIPIENT'S ADDRESS 3			
		TEST MAIL				
		NETWORK SERVICE	HTTP SERVER	NEW PASSWORD		
				CONFIRM PASSWORD		
			PJLink	NEW PASSWORD		
				CONFIRM PASSWORD		
			CLASS	CLASS1, CLASS2		
			DESTINATION			
		AMX BEACON	OFF, ON			
		Extron XTP	OFF, ON			
		SOURCE OPTIONS(1)	DEFAULT INPUT SELECT		LAST	LAST, AUTO, HDMI1, HDMI2, DisplayPort1, DisplayPort2, HDBaseT, SDI1, SDI2, SDI3, SDI4, SLOT
			SEAMLESS SWITCHING		OFF	OFF, ON
			BACKGROUND		BLUE	BLUE, BLACK, LOGO
	EDID VERSION		HDMI1	MODE2	MODE1, MODE2	
			HDMI2	MODE2	MODE1, MODE2	
	HDCP VERSION		HDMI1	HDCP2.2	HDCP2.2, HDCP1.4	
			HDMI2	HDCP2.2	HDCP2.2, HDCP1.4	
			HDBaseT	HDCP1.4	HDCP2.2, HDCP1.4	
	SOURCE OPTIONS(2)	SDI LINK			SINGLE, QUAD, QUAD (2SI), DUAL	
		DP LINK			SINGLE, DUAL	
	POWER OPTIONS	DIRECT POWER ON		OFF	OFF, ON	
		AUTO POWER ON SELECT		OFF	OFF, HDMI1, HDMI2, DisplayPort1, DisplayPort2, HDBaseT, SDI1, SDI2, SDI3, SDI4, SLOT	
		AUTO POWER OFF		OFF	OFF, 0:05, 0:10, 0:15, 0:20, 0:30, 1:00	
OFF TIMER		OFF	OFF, 0:30, 1:00, 2:00, 4:00, 8:00, 12:00, 16:00			
SLOT POWER		PROJECTOR ON		ON	OFF, ON	
		PROJECTOR STANDBY		ENABLE	DISABLE, ENABLE	
RESET	CURRENT SIGNAL					
	ALL DATA					
	ALL DATA (INCLUDING ENTRY LIST)					
	CLEAR FILTER HOURS					

5. Using On-Screen Menu

Menu Item		Default	Options
INFO.	USAGE TIME	LIGHT HOURS USED	
		FILTER HOURS USED	
		LOW FAN MODE HOURS USED	
	SOURCE(1)	INPUT TERMINAL	
		RESOLUTION	
		HORIZONTAL FREQUENCY	
		VERTICAL FREQUENCY	
		SYNC POLARITY	
		SCAN TYPE	
		SOURCE NAME	
	SOURCE(2)	ENTRY NO.	
		SIGNAL TYPE	
		BIT DEPTH	
		VIDEO LEVEL	
	WIRED LAN(1)	3D FORMAT	
		NETWORK INTERFACE	
		IP ADDRESS	
		SUBNET MASK	
		GATEWAY	
	WIRED LAN(2)	MAC ADDRESS	
		DNS	
		NETWORK INTERFACE	
		IP ADDRESS	
		SUBNET MASK	
	VERSION(1)	GATEWAY	
		MAC ADDRESS	
		DNS	
	OTHERS	FIRMWARE	
		DATA	
		FIRMWARE2	
		DATE TIME	
		PROJECTOR NAME	
	CONDITIONS	MODEL NO.	
		SERIAL NUMBER	
		CONTROL ID*4	
		LENS ID	
		INTAKE TEMPERATURE1	
		INTAKE TEMPERATURE2	
	HDBaseT	INTAKE TEMPERATURE3	
		INTAKE TEMPERATURE4	
		ATMOSPHERIC PRESSURE	
		ACIN VOLTAGE	
HDBaseT	SIGNAL QUALITY		
	OPERATION MODE		
	LINK STATUS		
	HDMI STATUS		

*4 [CONTROL ID] will be displayed when [CONTROL ID] has been set up.

4 Menu Descriptions & Functions [INPUT]

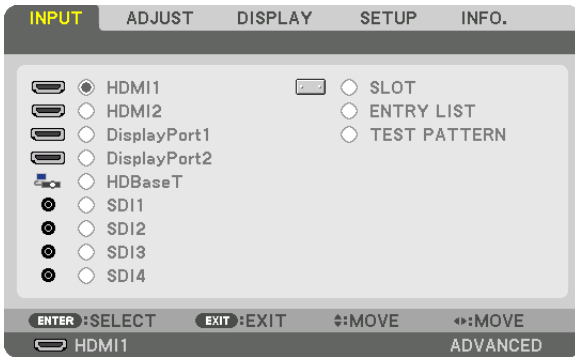

HDMI1

This projects the video of the device connected to the HDMI 1 IN terminal.

HDMI2

This projects the video of the device connected to the HDMI 2 IN terminal.

DisplayPort1

This projects the video of the device connected to the DisplayPort1 IN terminal. Select this port also when DisplayPort is connected in the dual link mode.

DisplayPort2

This projects the video of the device connected to the DisplayPort2 IN terminal.

HDBaseT

Projecting the HDBaseT signal.

SDI1

This projects the video of the device connected to the SDI1 IN terminal. Select this port also when SDI is connected in the quad link or dual link mode.

SDI2

This projects the video of the device connected to the SDI2 IN terminal.

SDI3

This projects the video of the device connected to the SDI3 IN terminal.

SDI4

This projects the video of the device connected to the SDI4 IN terminal.

SLOT

Projects the picture via the optional board (sold separately) inserted into the SLOT.

ENTRY LIST

Displays a list of signals. See the following pages.

TEST PATTERN

Closes the menu and switches to the test pattern screen. Select the pattern using the ◀▶ buttons.

Using the Entry List

When screen settings are made or lens memory registration is conducted, the signal adjustments are automatically registered in the unit's signal list. The (adjustment values of) registered signals can be loaded from the Entry List whenever necessary.

However, only up to 100 patterns can be registered in the Entry List. When 100 patterns have been registered in the Entry List, an error message is then displayed and no additional patterns can be registered. You should thus delete (adjustment values of) signals that are no longer needed.

Displaying the Entry list

1. Press the MENU button.

The menu will be displayed.

2. Press the ◀ or ▶ button to select [INPUT].

The INPUT list will be displayed.

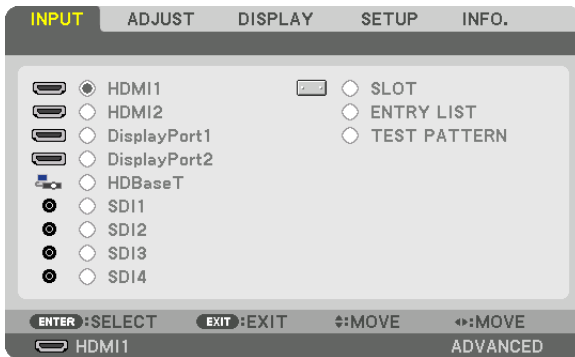

3. Use the ◀, ▶, ▲, or ▼ to select [ENTRY LIST] and press the ENTER button.

The ENTRY LIST windows will be displayed.

If the ENTRY LIST window is not displayed, switch the menu to [ADVANCED].

To switch the menu between [ADVANCED] and [BASIC], select [SETUP] → [CONTROL] → [TOOLS] → [ADMINISTRATOR MODE] → [MENU MODE]. (→ page 115)

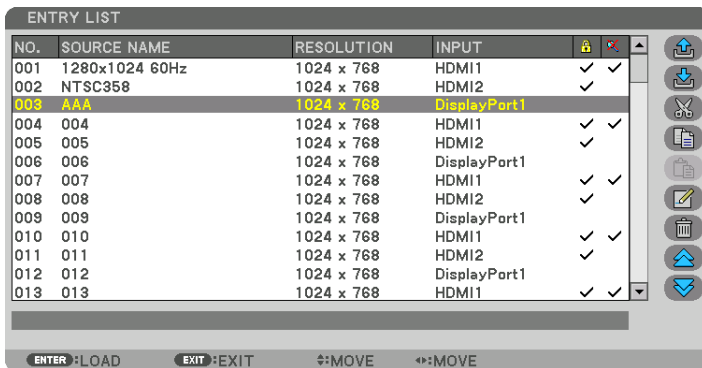

Entering the currently projected signal into the Entry List [ (STORE)]

1. Press the ▲ or ▼ button to select any number.
2. Press the ◀ or ▶ button to select [ (STORE)] and press the ENTER button.

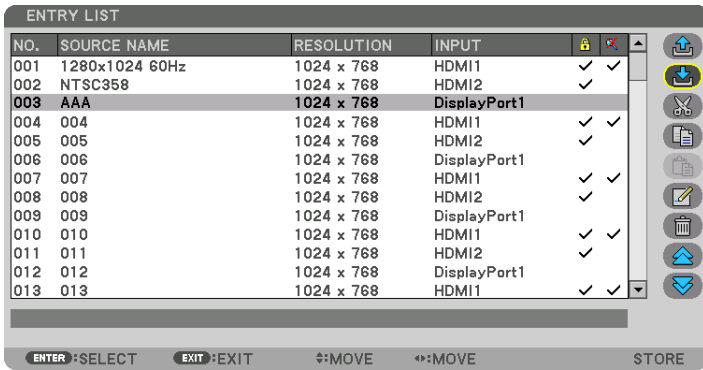

Calling up a signal from the Entry List [ (LOAD)]



Press the ▲ or ▼ button to select a signal and press the ENTER button.

Editing a signal from the Entry List [ (EDIT)]

1. Press the ▲ or ▼ button to select a signal you wish to edit.
2. Press the ◀, ▶, ▲, or ▼ button to select [ (EDIT)] and press the ENTER button.

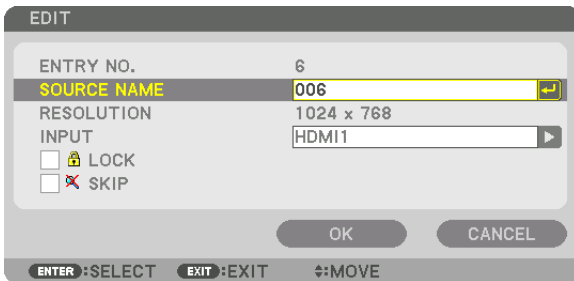
The EDIT window will be displayed.



SOURCE NAME	Enter a signal name. Up to 18 alphanumeric characters can be used.
INPUT	The input terminal can be changed.
 LOCK	Set so that the selected signal cannot be deleted when [ (ALL DELETE)] is executed. The changes made after LOCK execution cannot be saved.
 SKIP	Set so that the selected signal will be skipped during auto search.

3. Set the above items and select [OK] and press the ENTER button.

NOTE: The input terminal cannot be changed to the currently projected signal.

Cutting a signal from the Entry List [(CUT)]

1. Press the ▲ or ▼ button to select a signal you wish to delete.
2. Press the ◀, ▶, ▲, or ▼ button to select [ (CUT)] and press the ENTER button.

The signal will be deleted from the Entry List and the deleted signal will be displayed on the clipboard at the bottom of the Entry List.



NOTE:

- The currently projected signal cannot be deleted.
 - When the locked signal is selected, it will be displayed in gray which indicates it is not available.
-

TIP:

- Data on the clipboard can be passed onto the Entry List.
- Data on the clipboard will not be lost after the Entry List is closed.

Copying and pasting a signal from the Entry List [(COPY)] / [(PASTE)]

1. Press the ▲ or ▼ button to select a signal you wish to copy.
2. Press the ◀, ▶, ▲, or ▼ button to select [ (COPY)] and press the ENTER button.
The copied signal will be displayed on the clipboard at the bottom of the Entry List.
3. Press the ◀ or ▶ button to move to the list.
4. Press the ▲ or ▼ button to select a signal.
5. Press the ◀, ▶, ▲, or ▼ button to select [ (PASTE)] and press the ENTER button.

Data on the clipboard will be pasted to the signal.

Deleting all the signals from the Entry List [(ALL DELTE)]

1. Press the ◀, ▶, ▲, or ▼ button to select [ (ALL DELETE)] and press the ENTER button.
The confirmation message will be displayed.
2. Press the ◀ or ▶ button to select [YES] and press the ENTER button.

NOTE: The locked signal cannot be deleted.

Using Test Pattern [TEST PATTERN]

Displays the test pattern for adjusting distortion on the screen and the focus at the time of the projector setup. Once the [TEST PATTERN] on the onscreen menu is selected, the pattern for adjustment will be displayed on. If you find distortion on the pattern, adjust the projector installation angle or correct distortion by pressing the Geometric. button on the remote. If the focus adjustment is required, press the FOCUS button on the remote control for displaying the FOCUS adjustment screen and then adjust FOCUS by ◀ or ▶ button. Recommend to perform the focus adjustment after leaving the projector under the state the TEST PATTERN has been projected for over 30 minutes. Press EXIT button to close the test pattern and return to the menu.

5 Menu Descriptions & Functions [ADJUST] [PICTURE]

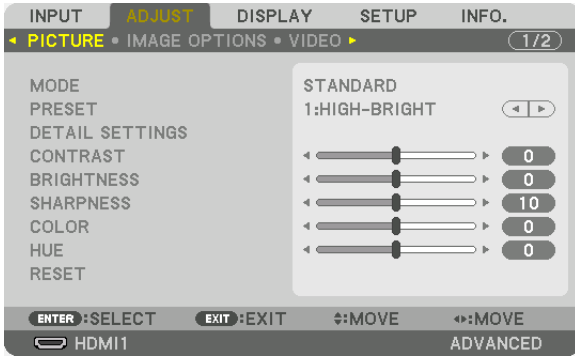

[MODE]

This function allows you to determine how to save settings for [DETAIL SETTINGS] of [PRESET] for each input.

- STANDARD Saves settings for each item of [PRESET] (Preset 1 through 7)
- PROFESSIONAL..... Saves all the settings of [PICTURE] for each input.

NOTE:

- When [TEST PATTERN] is displayed, [MODE] cannot be selected.

[PRESET]

This function allows you to select optimized settings for your projected image. You can adjust neutral tint for yellow, cyan or magenta.

There are seven factory presets optimized for various types of images. You can also use [DETAIL SETTINGS] to set user adjustable settings to customize each gamma or color.

Your settings can be stored in [PRESET 1] to [PRESET 7].

- AUTO This option automatically selects the appropriate mode for the signal type (for PC/VIDEO) based on the frequency, resolution, and color information of an input signal.
- HIGH-BRIGHT Recommended for use in a brightly lit room.
- PRESENTATION Recommended for making a presentation using a PowerPoint file.
- REC709..... Display colors conforming to the ITU-R BT.709 standard.
- CINEMA Display colors conforming to DCI-P3.
- REC2020..... Display colors close to the ITU-R BT.2020 standard.
- sRGB Standard color values
- DICOM SIM. Recommended for DICOM simulation format.

NOTE:

- The [DICOM SIM.] option is for training/reference only and should not be used for actual diagnosis.
- DICOM stands for Digital Imaging and Communications in Medicine. It is a standard developed by the American College of Radiology (ACR) and the National Electrical Manufacturers Association (NEMA).
The standard specifies how digital image data can be moved from system to system.

[DETAIL SETTINGS]

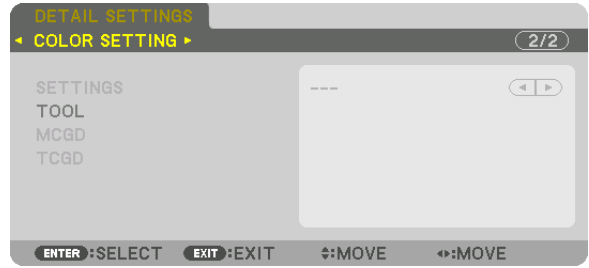
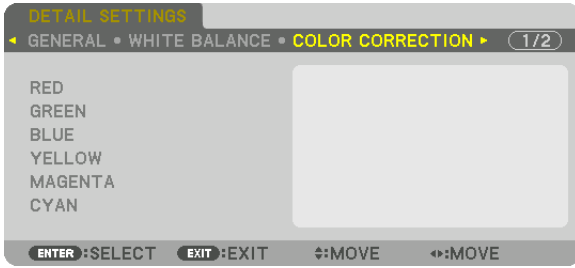
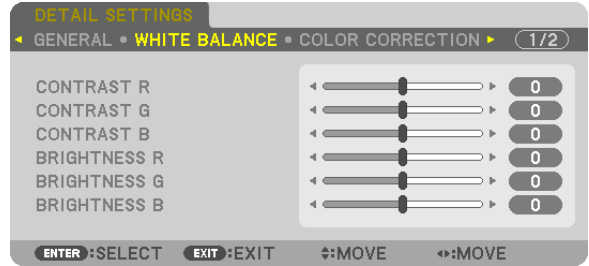
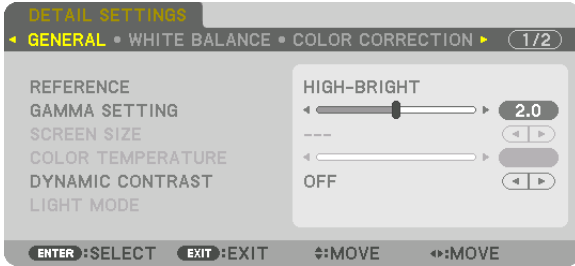

[GENERAL]

Storing Your Customized Settings [REFERENCE]

This function allows you to store your customized settings in [PRESET 1] to [PRESET 7].

First, select a base preset mode from [REFERENCE], then set [GAMMA SETTING] and [COLOR TEMPERATURE].

- HIGH-BRIGHT Recommended for use in a brightly lit room.
- PRESENTATION Recommended for making a presentation using a PowerPoint file.
- REC709..... Display colors conforming to the ITU-R BT.709 standard.
- CINEMA Display colors conforming to DCI-P3.
- REC2020..... Display colors close to the ITU-R BT.2020 standard.
- sRGB Standard color values.
- DICOM SIM. Recommended for DICOM simulation format.

Adjusting the gradation of the picture [GAMMA SETTING]

Adjusts the gradation of the picture. With this, even dark areas can be reproduced vividly.

NOTE: This function is not available when [DICOM SIM.] is selected for [DETAIL SETTINGS].

Selecting Screen Size for DICOM SIM [SCREEN SIZE]

This function will perform gamma correction appropriate for the screen size.

- LARGE For screen size of 300"
- MEDIUM For screen size of 200"
- SMALL..... For screen size of 100"

NOTE: This function is available only when [DICOM SIM.] is selected for [DETAIL SETTINGS].

Adjusting Color Temperature [COLOR TEMPERATURE]

This option allows you to select the color temperature of your choice.
A value from 3200K to 10500K can be set.

NOTE:

- When [HIGH-BRIGHT] or [PRESENTATION] is selected in [REFERENCE], this function is not available.
-

Adjusting Brightness and Contrast [DYNAMIC CONTRAST]

When set, the most optimal contrast ratio is adjusted according to the video.

OFF Dynamic contrast is disabled.

MOTION IMAGE..... Most optimal settings for moving images.

STILL IMAGE Most optimal settings for static images. Rapidly follows any changes in the video.

NOTE:

- Depending on the conditions, projector settings such as [DYNAMIC CONTRAST] may not be able to be selected.
-

Adjusting Brightness [LIGHT MODE]

Adjust the brightness of the projector and save it for each input signal. (→ page 41)

The adjustment is effective when [PROFESSIONAL] is selected for [MODE].

[LIGHT ADJUST]

Brightness can be adjusted in 1% increments from 30* to 100%.

* PH2601QL: 40%

[CONSTANT BRIGHTNESS]

OFF [CONSTANT BRIGHTNESS] mode will be canceled.

ON Maintains the brightness that is in effect at the time [ON] is selected. Unless [OFF] is selected, the same settings will remain in effect even when the projector is turned off.

- To re-adjust the brightness, first turn this setting OFF before making further adjustments.

NOTE:

- [CONSTANT BRIGHTNESS] mode is a function used to maintain the brightness at a constant level. Color will not be fixed.
 - The [CONSTANT BRIGHTNESS] setting will not be saved for each input signal.
-

Adjusting White Balance [WHITE BALANCE]

This allows you to adjust the white balance. Contrast for each color (RGB) to adjust the white level of the screen; Brightness for each color (RGB) is used to adjust the black level of the screen.

[COLOR CORRECTION]

Corrects the color for all signals.

Adjusts the tone for the colors red, green, blue, yellow, magenta and cyan.

RED	HUE	+ Direction	Magenta direction
		- Direction	Yellow direction
	SATURATION	+ Direction	Vivid
		- Direction	Weak
GREEN	HUE	+ Direction	Yellow direction
		- Direction	Cyan direction
	SATURATION	+ Direction	Vivid
		- Direction	Weak
BLUE	HUE	+ Direction	Cyan direction
		- Direction	Magenta direction
	SATURATION	+ Direction	Vivid
		- Direction	Weak
YELLOW	HUE	+ Direction	Red direction
		- Direction	Green direction
	SATURATION	+ Direction	Vivid
		- Direction	Weak
MAGENTA	HUE	+ Direction	Blue direction
		- Direction	Red direction
	SATURATION	+ Direction	Vivid
		- Direction	Weak
CYAN	HUE	+ Direction	Green direction
		- Direction	Blue direction
	SATURATION	+ Direction	Vivid
		- Direction	Weak

[COLOR SETTING]

The color range (color reproduction range) of the projected image can be adjusted by inputting the red, green, blue and white color coordinates of the projection light using a chroma meter that can measure color coordinates.

The specified color (target color: [TCGD]) can be reproduced by measuring the value of the native color (color without color compensation) and registering it in [MCGD].

Leave the light source on for at least 15 minutes before performing the [COLOR SETTING] in order to stabilize the brightness.

First set the [MCGD] color coordinates using the chroma meter, then set the color coordinates you want to display as the [TCGD]s.

We recommend using a spectral radiance meter with a narrow wavelength range that is capable of measuring the color range.

NOTE:

- The color setting cannot be performed when [HIGH-BRIGHT] has been selected for [DETAIL SETTINGS].

[SETTING]

Enables/disables the color setting.

When enabled, [MCGD] and [TCGD] can be set.

[MCGD]

Enter the color coordinates of the projected image.

REFERENCE..... Read the setting values of the RED/GREEN/BLUE/WHITE color coordinates.

STANDARD: This loads the factory settings. The red, green, blue and white color coordinates cannot be input.

USER1/USER2: Two user settings can be registered here.

RED/GREEN/BLUE/WHITE

..... Set the color coordinates.

Setting procedure:

1. Select red and press the ENTER button to switch to the red test pattern display.
2. Measure the center of the test pattern screen with a chroma meter.
3. Press the ENTER button again to switch to the color coordinate input screen.
4. Enter the measured value.

Move the cursor with the ◀▶ button and use the ▼▲ buttons to change the value.

5. Press the ENTER button to return to the [MCGD] setting screen.

Next, use the same procedure to input the green, blue and white color coordinates, and set the color coordinates for all four colors.

OK..... When [YES] is selected on the confirmation screen, the setting is entered and reflected on the projected image. The set values are stored under [USER1] or [USER2], whichever was selected for [REFERENCE], overwriting the values that were previously stored.

CANCEL When [YES] is selected on the confirmation screen, the values that were input are canceled.

NOTE:

- The value of [MCGD] will change with the projection environment; therefore, when the setup location or illumination conditions change, the value should be measured again.
 - Turn on the light at least 15 minutes before performing the color setting in order to stabilize the brightness.
-

[TCGD]

Sets the target color.

REFERENCE..... This displays the preset values (6 types) or the red, green, blue, cyan, magenta, yellow and white color coordinates of the previously set settings (USER1 to 10) as reference for inputting the target values.

RED/GREEN/BLUE/CYAN/MAGENTA/YELLOW/WHITE

..... Set the gain and color coordinates.

1. When red is selected and the ENTER button is pressed, the gain and color coordinate input screen is displayed.

Use the ◀▶ buttons to move the cursor, the ▼▲ buttons to change the values.

2. Press the ENTER button to return to the [TCGD] setting screen.

Next, use the same procedure to make the inputs for green, blue, cyan, magenta, yellow and white, and set the gain and color coordinates for all seven colors.

If [0] is input for each of cyan, magenta and yellow, the values are automatically calculated from the red, green and blue color coordinates, and these values are set.

SAVE..... Select where to save the RED/GREEN/BLUE/CYAN/MAGENTA/YELLOW/WHITE gain and color coordinates. Ten different settings can be saved.

OK..... When [YES] is selected on the confirmation screen, the settings are entered. The set values are saved in the location selected for [SAVE], overwriting the previously saved values.

NOTE:

- If no location for saving the values is selected for [SAVE] (i.e. is [---] is displayed), the set values are reflected temporarily, but they cannot be loaded subsequently. Be sure to select a location for saving the values (USER1 to 10).
-

CANCEL When [YES] is selected on the confirmation screen, the values that were input are canceled.

NOTE

- The value of [MCGD] will change with the projection environment; therefore, when the setup location or illumination conditions change, the value should be measured again.
 - The proper color cannot be displayed if the [TCGD] is outside of the range of colors that can be displayed with this unit.
 - There may be a discrepancy between the [TCGD] color coordinates and the values measured with the chroma meter, depending on the chroma meter being used and the environment in which the measurements are made.
-

[CONTRAST]

Adjusts the intensity of the image according to the incoming signal.

[BRIGHTNESS]

Adjusts the brightness level or the back raster intensity.

[SHARPNESS]

Controls the detail of the image.

[COLOR]

Increases or decreases the color saturation level.

[HUE]

Varies the color level from +/- green to +/- blue. The red level is used as reference.

NOTE:

- *When [TEST PATTERN] is displayed, [CONTRAST], [BRIGHTNESS], [SHARPNESS], [COLOR] and [HUE] cannot be adjusted.*
-

[RESET]

The settings and adjustments for [PICTURE] will be returned to the factory default settings with the exception of the following; Preset numbers and [REFERENCE] within the [PRESET] screen.

The settings and adjustments under [DETAIL SETTINGS] within the [PRESET] screen that are not currently selected will not be reset.

[IMAGE OPTIONS]

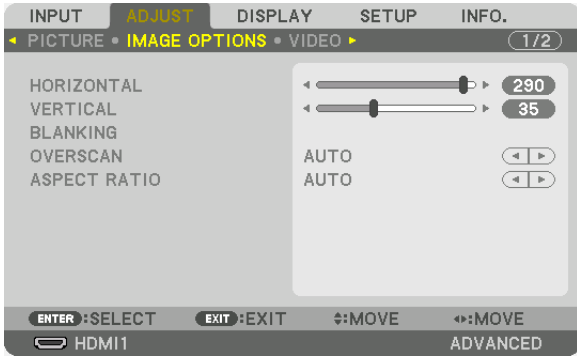

Adjusting Horizontal/Vertical Position [HORIZONTAL/VERTICAL]

Adjusts the image location horizontally and vertically.

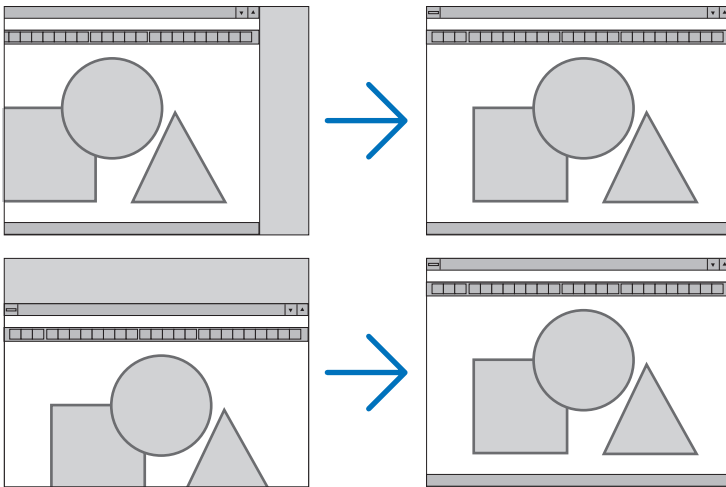

- The adjustments for [HORIZONTAL] and [VERTICAL] will be stored in memory for the current signal. The next time you project the signal with the same resolution, horizontal and vertical frequency, its adjustments will be called up and applied.

To delete adjustments stored in memory, from the menu, you select [SETUP] → [RESET] → [CURRENT SIGNAL] and reset the adjustments.

[BLANKING]

Adjusts the display range (blanking) at the top, bottom, left and right edges of the input signal.

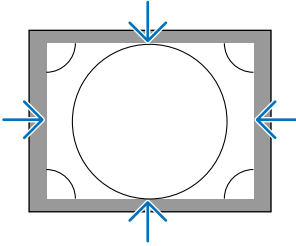

Selecting Overscan Percentage [OVERSCAN]

Select overscan percentage (Auto, 0%, 5% and 10%) for signal.

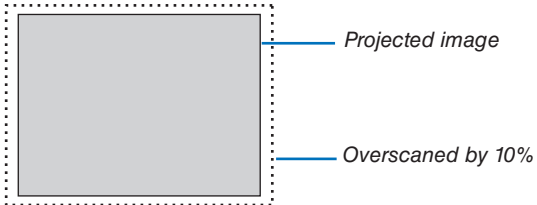

NOTE:

- The [OVERSCAN] item is not available:
 - when [NATIVE] is selected for [ASPECT RATIO].
-

Selecting the Aspect Ratio [ASPECT RATIO]

Use this function to select the screen's lateral:longitudinal aspect ratio. The projector automatically identifies the signal being input and sets the optimum aspect ratio.

For Computer signal

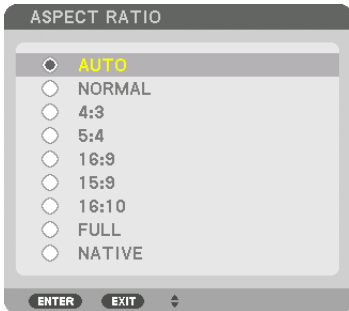

For HDTV/SDTV signals

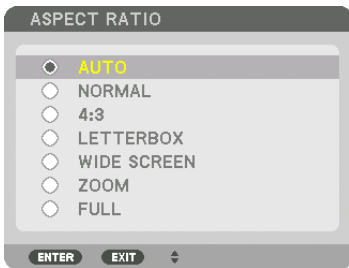

	Resolution	Aspect Ratio
VGA	640 × 480	4:3
SVGA	800 × 600	4:3
XGA	1024 × 768	4:3
WXGA	1280 × 768	15:9
WXGA	1280 × 800	16:10
HD(FWXGA)	1366 × 768	approx. 16:9
WXGA+	1440 × 900	16:10
SXGA	1280 × 1024	5:4
SXGA+	1400 × 1050	4:3
WXGA++	1600 × 900	16:9
UXGA	1600 × 1200	4:3
WSXGA+	1680 × 1050	16:10
FHD(1080P)	1920 × 1080	16:9
WUXGA	1920 × 1200	16:10
WQXGA	2560 × 1600	16:10
Quad HD	3840 × 2160	16:9
Quad HD	4096 × 2160	19:7

Options	Function
AUTO	The projector will automatically determine the incoming signal and display it in its aspect ratio. The projector may erroneously determine the aspect ratio depending on its signal. If this occurs, select the appropriate aspect ratio from the following.
NORMAL	The image is displayed in its original aspect ratio of its input signal..
4:3	The image is displayed in 4:3 aspect ratio.
5:4	The image is displayed in 5:4 aspect ratio
16:9	The image is displayed in 16:9 aspect ratio

5. Using On-Screen Menu

Options	Function
15:9	The image is displayed in 15:9 aspect ratio
16:10	The image is displayed in 16:10 aspect ratio
NATIVE	<p>The projector displays the current image in its true resolution when the incoming computer signal has a lower or higher resolution than the projector's native resolution. (→ page 3)</p> <p>When the incoming computer signal has a higher resolution than the projector's native resolution, the center of an image will be displayed.</p> <div data-bbox="569 415 1008 556" style="text-align: center;"> </div>
LETTER BOX	<p>The image of a letterbox signal (16:9) is stretched equally in the horizontal and vertical directions to fit the screen.</p> <div data-bbox="569 656 1008 788" style="text-align: center;"> </div>
WIDE SCREEN	<p>The image of a squeeze signal (16:9) is stretched left and right in 16:9.</p> <div data-bbox="569 859 1008 991" style="text-align: center;"> </div>
ZOOM	<p>The image of a squeeze signal (16:9) is stretched left and right in 4:3. Parts of the displayed image are cropped at the left and right edges and therefore not visible.</p> <div data-bbox="583 1091 994 1217" style="text-align: center;"> </div>
FULL	Project to full screen size.

[VIDEO]

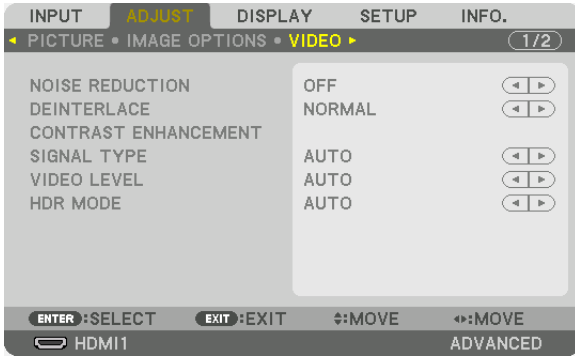

Using Noise Reduction [NOISE REDUCTION]

When projecting a video image, you can use the [NOISE REDUCTION] function to reduce the screen noise (roughness and distortion). Depending on the noise level, the noise reduction effect can be set to [OFF], [LOW], [MEDIUM] or [HIGH]. [NOISE REDUCTION] can be selected for SDTV, HDTV signal input.

Selecting Interlaced Progressive Conversion Process Mode [DEINTERLACE]

This function allows you to select an interlaced-to-progressive conversion process for video signals.

- NORMAL..... Automatically distinguishes a moving image from a static image to create a distinct image. Please select [MOVIE] if there are any obvious jitter and noises.
- MOVIE Select when projecting moving images. This is suitable for signals with a lot of jitter and noise.
- STILL..... Select when projecting static images. The video will flicker when a moving image is projected.

[CONTRAST ENHANCEMENT]

Using the characteristics of the human eye, a picture quality with a sense of contrast and resolution is achieved.

- OFF Suite vision is switched off.
- AUTO Contrast and picture quality are automatically improved using the suite vision function.
- NORMAL..... Adjust the gain manually.

[SIGNAL TYPE]

Selection of RGB and component signals. Normally, this is set to [AUTO]. Please change the setting if the color of the image remains unnatural.

- AUTO Automatically distinguishes RGB and component signals.
- RGB Switches to the RGB input.
- REC601 Switches to the component signal conforming to the ITU-R BT.601 standard.
Setting appropriate to SDTV images.
- REC709 Switches to the component signal conforming to the ITU-R BT.709 standard.
Setting appropriate to HDTV images.
- REC2020 Switches to the component signal conforming to the ITU-R BT.2020 standard.
Setting appropriate to 4K images.

[VIDEO LEVEL]

Selection of the video signal level when connecting an external device to the HDMI 1 IN terminal, HDMI 2 IN terminal, DisplayPort1 IN terminal, DisplayPort2 IN terminal, and HDBaseT IN terminal of the projector.

- AUTO The video level is switched automatically based on the information from the device outputting the signal.
Depending on the connected device, this setting may not be made properly. In this case, switch to [NORMAL] or [ENHANCED] from the menu and view with the optimum setting.
- NORMAL This disables the enhanced mode.
- ENHANCED This improves the image's contrast, expressing the dark and light sections more dynamically.
- SUPER WHITE The video contrast is improved and the dark areas appear more dynamic.

[HDR MODE]

- AUTO Automatically distinguishes HDR signal.
- OFF Projects the image based on the input signal
- ON Projects the image conforming to the HDR signal

NOTE: These options are available exclusively for 4K signal.

[3D SETTINGS(1)]

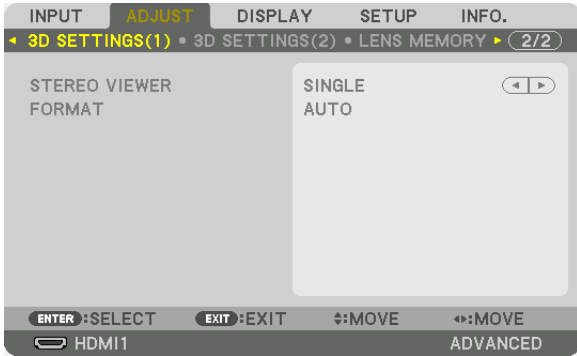

STEREO VIEWER

Adjusting the settings for projecting a 3D picture with one or multiple projectors. For 3D glasses right-eye and left-eye settings, select [STEREO VIEWER].

- SINGLE Use a single projector to project 3D videos.
- DUAL LEFT Use a dedicated projector for displaying videos on the left.
- DUAL RIGHT..... Use a dedicated projector for displaying videos on the right.

FORMAT

Select the 3D video format (recording / transmission format). Select to match the 3D broadcast and 3D media. Normally, [AUTO] is selected. Please select the 3D input signal format when the 3D detection signal of the format cannot be distinguished.

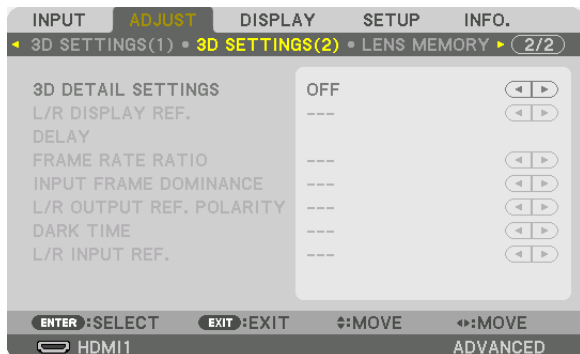
[3D SETTINGS(2)]**3D DETAIL SETTINGS**

Turning on this item enables the detailed settings of 3D so that you can set each item for 3D. Set [3D DETAIL SETTING] to meet your 3D image system requirements. If you do this incorrectly, your 3D image will not be displayed correctly.

L/R DISPLAY REF.

Select when displaying a 3D image using L/R timing (left eye/right eye) of a 3D signal from the DISPLAY REFERENCE terminal.

DELAY

Adjust delay values (time or phase) of output reference.

TIME -32768 to 36767 μ s

PHASE -180 to 180 deg

FRAME RATE RATIO

Select a frame rate ratio of 3D.

INPUT FRAME DOMINANCE

Select the order of L/R (left eye/right eye) of an input image.

L/R OUTPUT REF. POLARITY

Select the polarity of 3D output image information (left eye/right eye).

DARK TIME

Specify a time between 0 and 65535 μ s.

L/R INPUT REF.

Select when displaying a 3D image using L/R timing (left eye/right eye) of a 3D signal from the INPUT REFERENCE terminal.

Using the Lens Memory Function [LENS MEMORY]

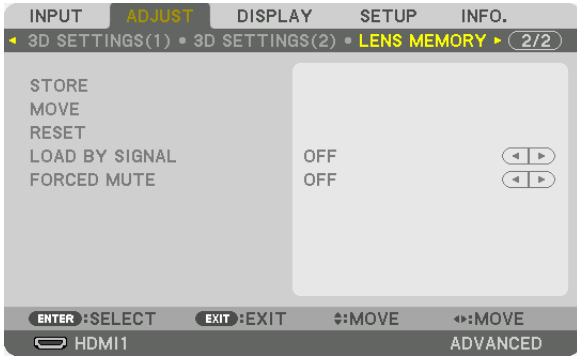

This function serves to store the adjusted values for each input signal when using the LENS SHIFT, ZOOM and FOCUS buttons of the projector. Adjusted values can be applied to the signal you selected. This will eliminate the need to adjust lens shift, focus, and zoom at the time of source selection.

- STORE Stores the current adjusted values in memory for each input signal.
- MOVE Applies the adjusted values to the current signal.
- RESET..... Returns the adjusted values to the last condition.
- LOAD BY SIGNAL .. When you switch signals the lens will shift to the adjusted values of lens shift, zoom, and focus.
- FORCED MUTE To turn off the image during lens shift, select [ON].

NOTE:

- Lens memory adjustments will be automatically registered the ENTRY LIST. These lens memory adjustments can be loaded from the ENTRY LIST. (→ page 79)
Note that performing [CUT] or [ALL DELETE] in the ENTRY LIST will delete lens memory adjustments as well as source adjustments. This deletion will not take effect until other adjustments is loaded.
- For storing each adjustment of lens shift, zoom and focus as common value for all input signal, store them as reference lens memory.

To store your adjusted values in [LENS MEMORY]:

1. **Project the connected device signal you want to adjust.**
2. **Adjust the projecting image of position, size and focus by the L-SHIFT, ZOOM +/-, and FOCUS +/- buttons.**
 - Adjustment can be performed by the remote control. Please refer to “6 Adjusting the Picture Size and Position” on page 28.
 - Slight adjustment by moving the projector position and by the tilt foot is not subject of [LENS MEMORY].
3. **Move the cursor on [STORE] and press ENTER.**

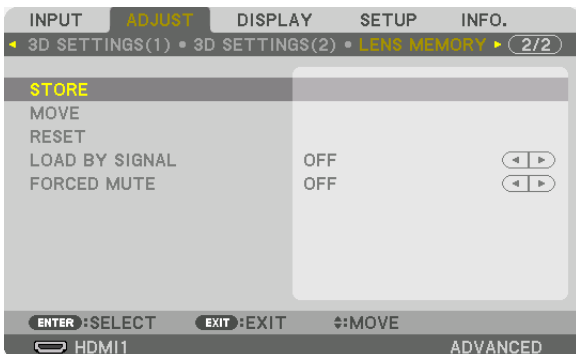

4. **Move the cursor on [YES] and press ENTER.**

To call up the adjusted values from [LENS MEMORY]:

1. From the menu, select [ADJUST] → [LENS MEMORY] → [MOVE] and press the ENTER button.



The confirmation screen will be displayed.

2. Press the ◀ button to select and [YES] and press the ENTER button.

To automatically apply the adjusted values at the time of source selection:

1. From the menu, select [ADJUST] → [LENS MEMORY] → [LOAD BY SIGNAL] and press the ENTER button.

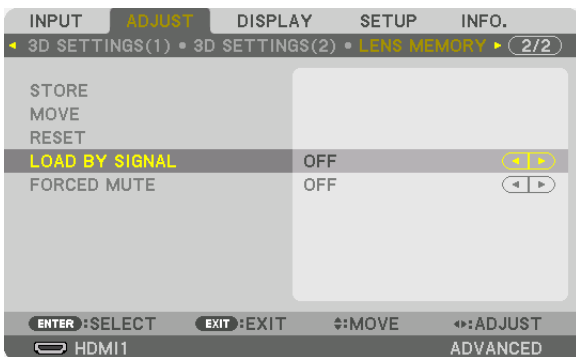

2. Press the ▼ button to select and [ON] and press the ENTER button.

This will move the lens automatically to the position at the time of source selection according to the adjusted values.

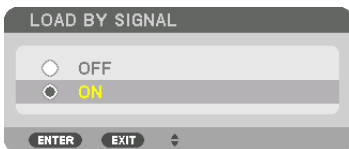

NOTE:

- The Lens Memory function may not produce a completely aligned image (due to tolerances in the lenses) using the adjusted values stored in the projector. After calling up and applying the adjusted values from the Lens Memory function, finely adjust the lens shift, zoom and focus to produce the best possible image.

⑥ Menu Descriptions & Functions [DISPLAY] [PICTURE BY PICTURE]

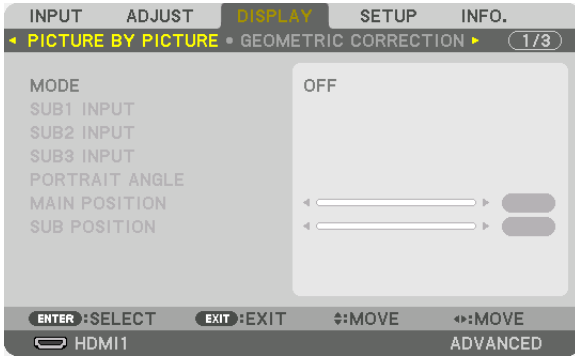

Please refer to "② Using a single projector to project two or four types of videos at the same time [PICTURE BY PICTURE]" (→ page 58) for the operation.

MODE

Switch to a single-screen display, a two-screen display, or a four-screen display.

SUB1 INPUT/SUB2 INPUT/SUB3 INPUT

Select an input signal to be displayed on the sub screen.

Two-screen display

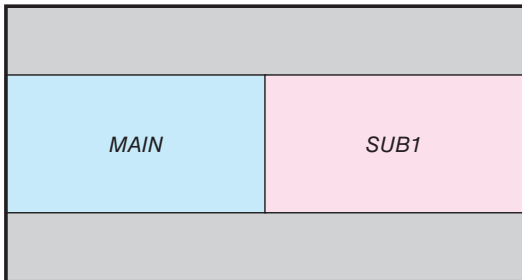

Four-screen display

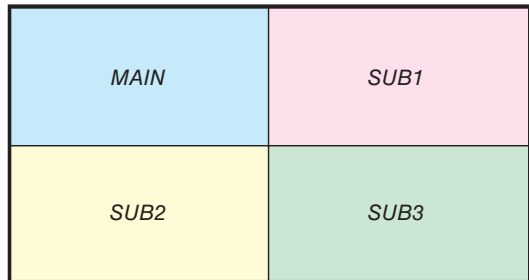

SUB1 INPUT	Select an input signal to be displayed in the SUB 1 screen for a two-screen display or a four-screen display. <i>NOTE:</i> • <i>HDBaseT and SLOT are available only when [MODE] is set to [DUAL].</i>
SUB2 INPUT	Select an input signal to be displayed in the SUB 2 screen for a four-screen display.
SUB3 INPUT	Select an input signal to be displayed in the SUB 3 screen for a four-screen display.

PORTRAIT ANGLE

Select the angle of screen orientation for a two-screen display in the portrait projection.

MAIN POSITION/SUB POSITION

Adjust the vertical position of image for a two-screen display.

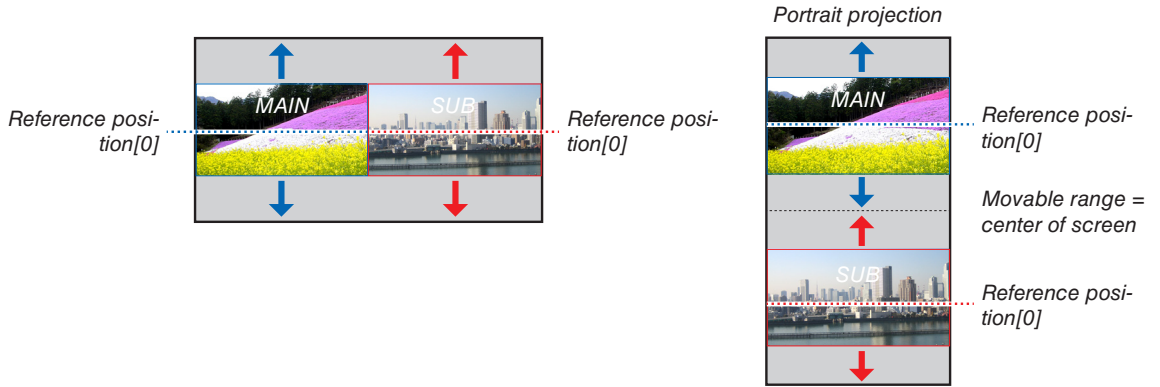

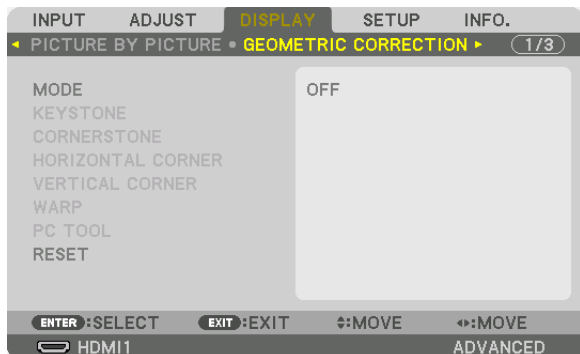
[GEOMETRIC CORRECTION]**MODE**

Set pattern for correcting distortion. If [OFF] is selected, the [GEOMETRIC CORRECTION] becomes ineffective. If you need to change the [MENU ANGLE], make sure to change it before performing the [GEOMETRIC CORRECTION]. If [MENU ANGLE] is changed after performing the [GEOMETRIC CORRECTION], corrected values will be reset to the default values.

KEYSTONE

Correct distortion in horizontal and vertical directions.

HORIZONTAL..... Adjustments when projecting from a diagonal direction to the screen.

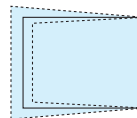

VERTICAL Adjustments when projecting from the top or bottom direction to the screen.

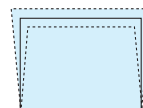

TILT Adjusts the distortion when performing trapezoidal correction with the screen moved in the vertical direction using the lens shift.

THROW RATIO..... Adjusts according to the projection ratio of the optional lens used.

Model name of lens unit	Adjustment range
L2K-10F1	9
L4K-11ZM	12-17
L4K-15ZM	15-21
L4K-20ZM	20-33
L2K-30ZM	27-39
L2K-43ZM1	39-55
L2K-55ZM1	50-78

NOTE:

- When power is supplied to the device, the adjustment value of the [KEYSTONE] used previously is retained even if the gradient of the device is changed.
- As electrical correction is carried out by [KEYSTONE], the brightness may be reduced or the screen quality may deteriorate sometimes.

CORNERSTONE

Display the 4-point correction screen and adjust the trapezoidal distortion of the projection screen. Please refer to "Correcting Horizontal and Vertical Keystone Distortion [CORNERSTONE]" (→ page 42) for details on the operation.

HORIZONTAL CORNER/VERTICAL CORNER

Distortion correction for corner projection such as wall surfaces.

HORIZONTAL CORNER

..... Performs correction for projection onto a wall lying at an angle to the horizontal direction.

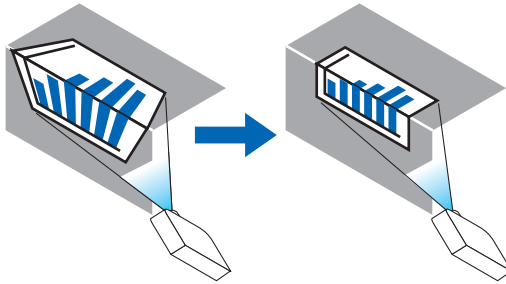

* Reverse angle correction is also possible.

VERTICAL CORNER

..... Performs correction for projection onto a wall lying at an angle to the vertical direction.

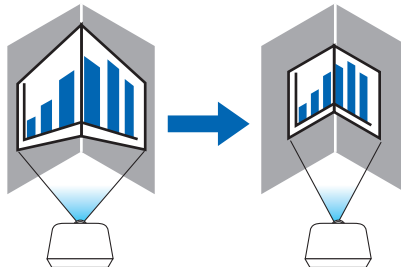

* Reverse angle correction is also possible.

NOTE:

- When the maximum adjustment range is exceeded, distortion adjustment is disabled. Set up the projector at an optimal angle as the deterioration in the image quality increases as the distortion adjustment volume gets larger.
 - Please note that the image will go out of focus due to the difference in the distance between the upper and lower or left and right sides and the center of the screen for projections cutting across corners. Lenses with short focal points are also not recommended for projections cutting across corners as the image will go out of focus.
-

Adjustment method

1. **Align the cursor with the [HORIZONTAL CORNER] or [VERTICAL CORNER] of the [GEOMETRIC CORRECTION] menu and then press the ENTER button.**
 - The adjustment screen will be displayed.
2. **Press the ▼▲◀▶ buttons to align the cursor (yellow box) with the target adjustment point and then press the ENTER button.**
 - The cursor will change into an adjustment point (yellow in color).
3. **Press the ▼▲◀▶ buttons to adjust the corners or sides of the screen and then press the ENTER button.**
 - The adjustment point will go back to being a cursor (yellow box).

Explanation of screen transition

- The adjustment points of the four corners (a, c, f and h in the drawing) will move independently.
- The following adjustment points differ at the [HORIZONTAL CORNER] and [VERTICAL CORNER].
HORIZONTAL CORNER: When Point b in the drawing is moved, and the upper side and Point g are moved, the lower side will move in a parallel manner.
VERTICAL CORNER: When Point d in the drawing is moved, and the left side and Point e are moved, the right side will move in a parallel manner.

[Adjustment points of the [HORIZONTAL CORNER] screen and movement points of the projection screen]

Point b will be displaced in a parallel manner at the same time as Points a, b, c

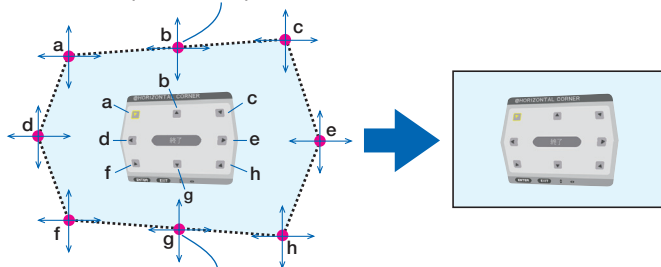

Point g will be displaced in a parallel manner at the same time as Points f, g, h

[Adjustment points of the [VERTICAL CORNER] screen and movement points of the projection screen]

Point d will be displaced in a parallel manner at the same time as Points a, d, f

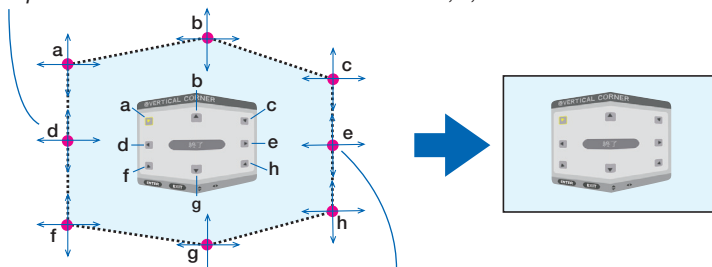

Point e will be displaced in a parallel manner at the same time as Points f, g, h

4. **Start from Step 2 onwards to adjust the other points.**
5. **When the adjustment is completed, press the ▼▲◀▶ buttons to align the cursor with the [EXIT] in the adjustment screen and then press the ENTER button.**
 - Switch to the [GEOMETRIC CORRECTION] menu screen.

WARP

Correct projected image distortion on a specific surface as a column or a sphere.

NOTE:

- When the maximum adjustment range is exceeded, distortion adjustment is disabled. Set up the projector at an optimal angle since the more the adjustment volume gets large, the more image quality gets deterioration.
- Please note that the image will go out of focus due to the difference in the distance between peripheries and the center of the screen for projections cutting across corners as on a column or a sphere. Lenses with short focal points are also not recommended for projections cutting across corners as the image will go out of focus.

Adjustment method

1. **Align the cursor with the [WARP] of the [GEOMETRIC CORRECTION] menu and then press the ENTER.**
 - Adjustment screen will be displayed on.
2. **Press the ▼▲◀▶ buttons to align the cursor (blue box) with the target adjustment point and then press the ENTER.**
 - The cursor will change into an adjustment point (yellow in color).
3. **Press the ▼▲◀▶ buttons to adjust the corners or sides of the screen and then press the ENTER.**
 - The cursor will back to yellow box.

Explanation for correcting distortion

- Eight adjustment points can be moved independently.
- For left and right sides, use ◀▶ buttons for adjusting the range of distortion, and ▼/▲ buttons for adjusting the distortion peak.
- For top and bottom sides, use ▼/▲ buttons for adjusting the range of distortion, and ◀▶ buttons for adjusting the distortion peak.
- For corners, use ▼▲◀▶ buttons for moving positions.

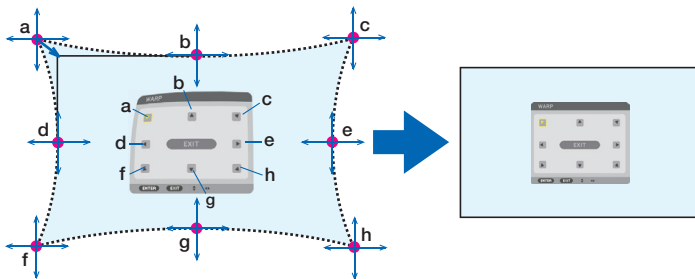

4. **For adjusting other points, repeat Step2 onwards.**
5. **When the adjustment is completed, move the cursor onto the [EXIT] on the adjustment screen and press the ENTER.**
 - The screen will be switched to the [GEOMETRIC CORRECTION] menu.
The adjustment completion screen will be displayed on.
6. **Press ◀ or ▶ button to move the cursor onto [OK] then press [ENTER].**
 - The adjusted values for WARP are stored and the screen display goes back to the [GEOMETRIC CORRECTION].

PC TOOL

Recall the geometric correction data that is registered in the projector beforehand.
Three types of correction data can be registered.

NOTE:

- *As electrical correction is carried out in geometric correction, the brightness may be affected and the picture quality may be degraded.*
-

RESET

Reset the adjustment value that has been set up as MODE in GEOMETRIC CORRECTION (return to the initial value).

- This is ineffective when MODE is set OFF.
- Reset can be executed by pressing and holding the 3D REFORM button on the remote control for over 2 seconds.

[EDGE BLENDING]

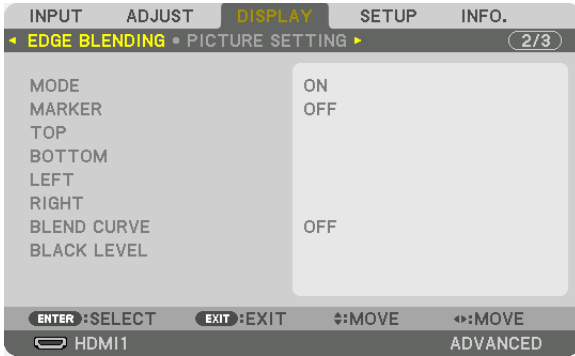

This adjusts the edges (boundaries) of the projection screen when projecting high resolution videos using a combination of several projectors in the up, down, left and right positions.

MODE

This enables or disables the EDGE BLENDING function. When [MODE] is set to [ON], the [MARKER], [TOP], [BOTTOM], [LEFT], [RIGHT], [BLACK LEVEL] and [BLEND CURVE] settings can be adjusted.

MARKER

Set whether to display marker or not when adjusting the range and display position. When turned on, a magenta marker for adjusting the range adjustment and a green marker for adjusting the display position will be displayed.

TOP/BOTTOM/LEFT/RIGHT

This selects the EDGE BLENDING locations on the left, right, top and bottom on the screen. The following settings can be adjusted when an item is selected. (→ page 65)

- CONTROL Enable TOP, BOTTOM, LEFT and RIGHT functions.
- RANGE..... Adjust the range (width) of the edge blending.
- POSITION Adjust the display position of the edge blending.

BLEND CURVE

Set brightness for the [EDGE BLENDING] sections. (→ page 67)

BLACK LEVEL

Adjust the black level of the [EDGE BLENDING] section. (→ page 68)

[PICTURE SETTING]

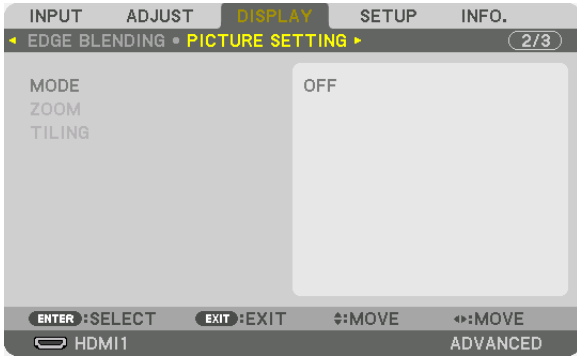

This sets the division conditions for reducing or enlarging the image area and displaying it in the desired position or for projecting using a combination of several projectors. Please refer to "4. Multi-Screen Projection" (→ page 57) for details.

MODE	OFF	Use the projector in a standalone state.
	ZOOM	This adjusts the position and width of the video area that you wish to divide. The edge blending width will also be automatically set to that width.
ZOOM	HORIZONTAL ZOOM	This enlarges the video area in the horizontal direction.
	VERTICAL ZOOM	This enlarges the video area in the vertical direction.
	HORIZONTAL POSITION	This shifts the video area in the horizontal direction.
	VERTICAL POSITION	This shifts the video area in the vertical direction.
TILING	WIDTH	This selects the number of projectors to be arranged horizontally.
	HEIGHT	This selects the number of projectors to be arranged vertically.
	HORIZONTAL POSITION	This selects the position of the projector starting from the left among those arranged horizontally.
	VERTICAL POSITION	This selects the position of the projector starting from the top among those arranged vertically.

Conditions for using tiling

- All the projectors need to fulfil the following conditions.
 - The panel size must be the same
 - The projection screen size must be the same
 - The left and right ends or top and bottom ends of the projection screen must be consistent.
 - The settings for the left and right edges of the edge blending are the same
 - The settings for the top and bottom edges of the edge blending are the same

If the tiling conditions are satisfied, the video screen of the projector at each installation position will be automatically extracted and projected.

If the tiling conditions are not satisfied, adjust the video screen of the projector at each installation position using the zoom function.

- Assign a unique control ID to each projector.
- Set the “Color setting” and “DeepColor setting” on your Blu-ray player or computer to “Auto”. Refer to the owner’s manual accompanied with your Blu-ray player or computer for more information.

Tiling setting example) Number of horizontal units = 2, Number of vertical units = 2

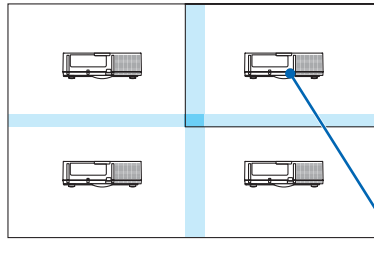

Horizontal order = Second unit
Vertical order = First unit

[MULTI SCREEN]

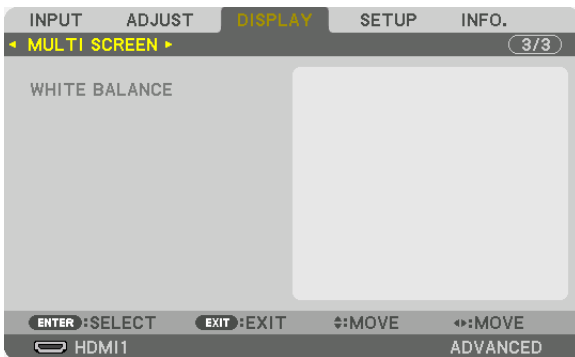

WHITE BALANCE

This adjusts the white balance for each projector when projecting using a combination of several projectors. This can be adjusted when [MODE] is set to [ON].

- CONTRAST W, CONTRAST R, CONTRAST G, CONTRAST B
..... Adjusting the white color of the video.
- BRIGHTNESS W, BRIGHTNESS R, BRIGHTNESS G, BRIGHTNESS B
..... Adjusting the black color of the video.

7 Menu Descriptions & Functions [SETUP]

[MENU(1)]



Selecting Menu Language [LANGUAGE]

You can choose one of 30 languages for on-screen instructions.

NOTE: Your setting will not be affected even when [RESET] is done from the menu.

Selecting Menu Color [COLOR SELECT]

You can choose between two options for menu color: COLOR and MONOCHROME.

Turning On / Off Source Display [INPUT DISPLAY]

This option turns on or off input name display such as HDMI1 to be displayed on the top right of the screen.

Turning messages on and off [MESSAGE DISPLAY]

This option selects whether or not to display projector messages at the bottom of the projected image. Even when "OFF" is selected, the security lock warning is displayed. The security lock warning turns off when the security lock is canceled.

Turning ON/OFF Control ID [ID DISPLAY]

This option turns on or off the ID number which is displayed when the ID SET button on the remote control is pressed. (→ page 120)

[3D CAUTION MESSAGE]

This selects whether to display a caution message or not when switching to a 3D video. The default condition when shipped from the factory is ON.

- OFF The 3D caution message screen will not be displayed.
- ON The 3D caution message screen will be displayed when switching to a 3D video. Press the ENTER button to cancel the message.
 - The message will disappear automatically after 60 seconds or when other buttons are pressed. If it disappears automatically, the 3D caution message will be displayed again when switching to a 3D video.

Selecting Menu Display Time [DISPLAY TIME]

This option allows you to select how long the projector waits after the last touch of a button to turn off the menu. The preset choices are [MANUAL], [AUTO 5 SEC], [AUTO 15 SEC], and [AUTO 45 SEC]. The [AUTO 45 SEC] is the factory preset.

Selecting Interval Time for Filter Message [FILTER MESSAGE]

This option allows you to select the time preference between displaying the message for cleaning the filters. Clean the filter when you get the message "PLEASE CLEAN FILTER." (→ page 139)

Eight options are available: OFF, 100[H], 500[H], 1000[H], 2000[H], 5000[H], 10000[H], 20000[H]

The default setting is [OFF].

NOTE: Your setting will not be affected even when [RESET] is done from the menu.

[MENU(2)]

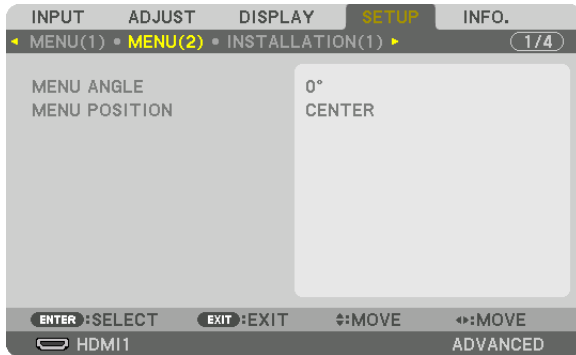

[MENU ANGLE]

Select the direction for displaying the menu.

[MENU POSITION]

Shift the menu displaying position. You can choose from 9 locations.

TIP

- The display position of the menu is saved even when the power supply of the projector is turned off.
- When you change the [MENU ANGLE], the display position of the menu returns to the original state when it was first shipped from the factory.
- Input terminal and message displaying position are not influenced by the [MENU POSITION].

[INSTALLATION(1)]

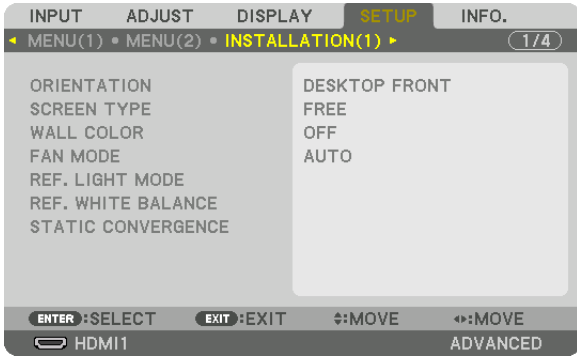

Selecting Projector Orientation [ORIENTATION]

This reorients your image for your type of projection. The options are: desktop front projection, ceiling rear projection, desktop rear projection, and ceiling front projection.

NOTE:

- Please consult the distributor if you require special installation services e.g. when mounting the projector to a ceiling or suspending from the ceiling using eye bolts. Never install the projector on your own. This may result in the projector falling down and causing injury to people.

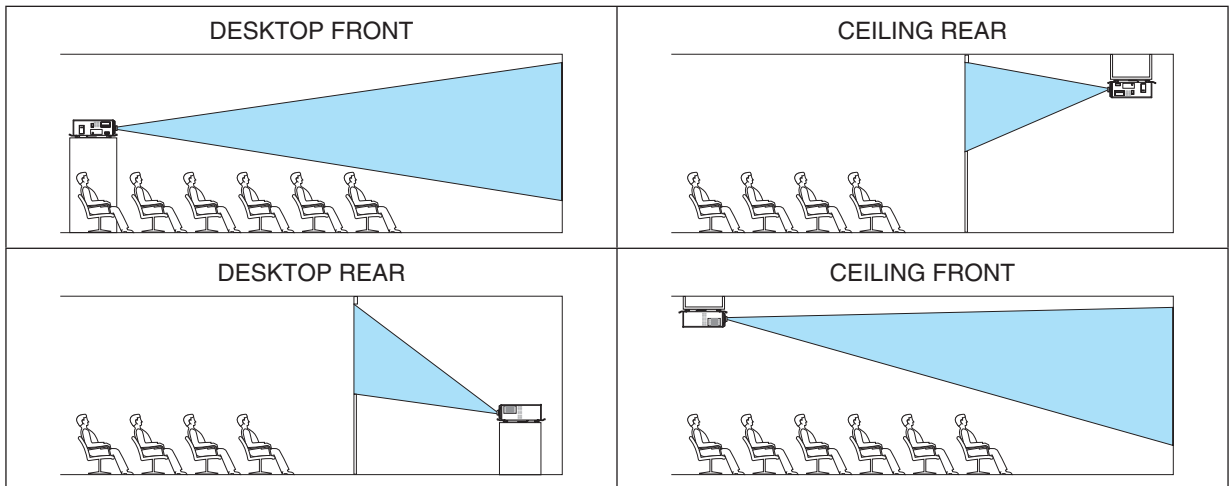

Selecting Aspect Ratio and Position for Screen [SCREEN TYPE]

Sets the aspect ratio of the projection screen.

- FREE The ratio of panel is selected. Select this when projecting 17:9 screen (4K).
- 4:3 SCREEN For a screen with a 4:3 aspect ratio
- 16:9 SCREEN For a screen with a 16:9 aspect ratio
- 16:10 SCREEN For a screen with a 16:10 aspect ratio

NOTE:

- After changing the screen type, check the setting of [ASPECT RATIO] in the menu. (→ page 90)

Using the Wall Color Correction [WALL COLOR]

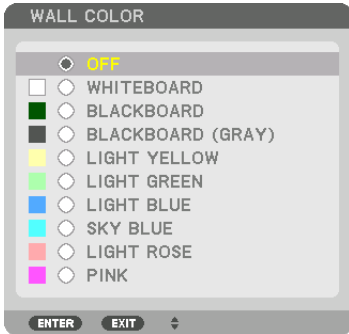

This function allows for quick adaptive color correction in applications where the screen material is not white.

NOTE: Selecting [WHITEBOARD] reduces light source brightness.

Selecting Fan Mode [FAN MODE]

Fan Mode is used to set the speed of the internal cooling fan.

- AUTO The built-in fans automatically run at variable speed according to the detected temperature and atmospheric pressure by the built-in sensor.
- HIGH The built-in fans run at high speed
- LOW The fan speed is decreased, reducing noise.

NOTE:

- Make sure the speed is set to [HIGH] when you are using this device continuously for several days.
- Set [FAN MODE] to [AUTO] when using the projector at altitudes approximately 5500 feet/1700 meters or higher.
- Using the projector at altitudes approximately 5500 feet/1700 meters or higher without setting to [AUTO] can cause the projector to overheat and the protector could shut down. If this happens, wait a couple minutes and turn on the projector.
- Internal parts may need to be replaced earlier in the following situations.
 - When using this unit at a high altitude
 - When the unit is used in a high temperature environment
 - When the unit is used with the fan mode set to [LOW]
- Your setting will not be affected even when [RESET] is done from the menu.
- Using the unit continuously with the fan mode set to [LOW] will reduce the service life of the light source.

[REF. LIGHT MODE]

Adjust this when you want to use the unit with a lower brightness or when you want to save energy. This can also be used to adjust the brightness between the different projectors when using a combination of multiple projectors.

REF. LIGHT ADJUST		Brightness can be adjusted in 1% increments from 30* to 100%.
CONSTANT BRIGHTNESS	OFF	[CONSTANT BRIGHTNESS] mode will be canceled.
	ON	Maintains the brightness that is in effect at the time [ON] is selected. Unless [OFF] is selected, the same settings will remain in effect even when the projector is turned off. <ul style="list-style-type: none"> To re-adjust the brightness, first turn this setting OFF before making further adjustments. <p><i>NOTE:</i></p> <ul style="list-style-type: none"> [CONSTANT BRIGHTNESS] mode is a function used to maintain the brightness at a constant level. Color will not be fixed.

* PH2601QL: 40%

TIP:

- When using multi-screen projection, it is recommended to adjust the brightness to a slightly lower level, then setting the [CONSTANT BRIGHTNESS] mode to [ON].

[REF. WHITE BALANCE]

This feature allows you to adjust the white balance for all signals.

The white and black levels of the signal are adjusted for optimum color reproduction.

Uniformity is also adjusted when the redness (R) and blueness (B) of the white color in the screen's horizontal (left/right) direction are uneven.

CONTRAST R/CONTRAST G/CONTRAST B

..... These adjust the picture's white color.

BRIGHTNESS R/BRIGHTNESS G/BRIGHTNESS B

..... These adjust the picture's black color.

UNIFORMITY R..... The further this is set to the + side, the stronger the redness on the left side of the picture (increasing towards the left edge) and the weaker the redness on the right side of the picture (decreasing towards the right edge).

This is reversed when set to the – side.

UNIFORMITY B..... The further this is set to the + side, the stronger the blueness on the left side of the picture (increasing towards the left edge) and the weaker the blueness on the right side of the picture (decreasing towards the right edge).

This is reversed when set to the – side.

[STATIC CONVERGENCE]

This features allows you to adjust for color deviation in the picture.

This can be adjusted in units of –3 to 0 pixel in the horizontal direction for HORIZONTAL R, G and B, in the vertical direction for VERTICAL R, G and B.

[INSTALLATION(2)]**[SHUTTER SETTINGS]**

Enabling and disabling the lens shutter function. You can also set how long the light will take to fade in and fade out when either the SHUTTER button.

POWER ON SHUTTER	OPEN	When the power is turned on, the lens shutter opens and the picture is projected.
	CLOSE	The lens shutter remains closed even when the power is turned on. Press the SHUTTER button to open the shutter and project the picture.
PICTURE MUTE SHUTTER	OPEN	The lens shutter remains open when the picture disappears e.g. when the input terminal is switched and so on.
	CLOSE	The lens shutter closes when the picture disappears e.g. when the input terminal is switched and so on.
FADE IN TIME	Set how long the light will take to fade in after the SHUTTER button is pressed. The time can be set from 0 to 10 seconds in increments of 1 second.	
FADE OUT TIME	Set how long the light will take to fade out after the SHUTTER button is pressed. The time can be set from 0 to 10 seconds in increments of 1 second.	

Using the Reference Lens Memory Function [REF. LENS MEMORY]

This function serves to store the adjusted values common to all input sources when using the LENS SHIFT, ZOOM and FOCUS buttons of the projector or the remote control. The adjusted values stored in memory can be used as a reference to the current.

PROFILE Select a stored [PROFILE] number.

STORE Stores the current adjusted values in memory as a reference.

MOVE Applies the adjusted reference values stored in [STORE] to the current signal.

RESET..... Reset selected [PROFILE] number [REF. LENS MEMORY] to the factory default settings.

LOAD BY SIGNAL .. When you switch signals the lens will shift to the lens shift, zoom, and focus values for the selected [PROFILE] number.

If no adjusted values have been saved to [LENS MEMORY], the lens will apply [REF. LENS MEMORY] adjusted values. Alternatively, if no adjusted values have been saved to [REF. LENS MEMORY], the unit will return to factory default settings.

FORCED MUTE To turn off the image during lens shift, select [YES].

NOTE:

- Adjusted values in [REF. LENS MEMORY] will not be returned to default when performing [CURRENT SIGNAL] or [ALL DATA] for [RESET] from the menu.
- To store adjusted values for each input source, use the Lens Memory function. (→ page 96)

[LENS POSITION]

Set back the lens to the home position.

[LENS CALIBRATION]

The adjustment range of the zoom, focus, and shift of the mounted lens is calibrated.

The SHUTTER indicator flashes green while lens calibration is being performed.

Be sure to carry out [LENS CALIBRATION] after installing the lens unit L4K-11ZM/L4K-15ZM/L4K-20ZM.

[CONTROL]

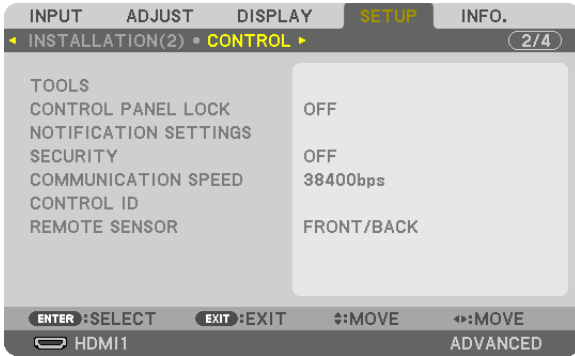

TOOLS

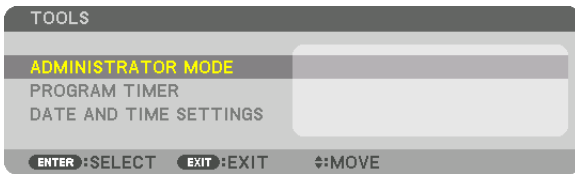

ADMINISTRATOR MODE

This allows you to select MENU MODE, save settings, and set a password for the administrator mode.

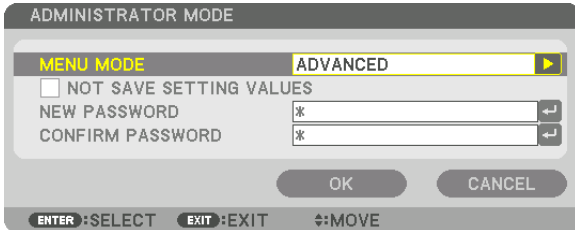

MENU MODE	Select either [BASIC] or [ADVANCED] menu. (→ page 72)	—
NOT SAVE SETTING VALUES	Placing a check mark will not save your projector settings. Clear this check box to save your projector settings.	—
NEW PASSWORD/ CONFIRM PASS- WORD	Assign a password for the administrator mode.	Up to 10 alphanumeric characters

PROGRAM TIMER

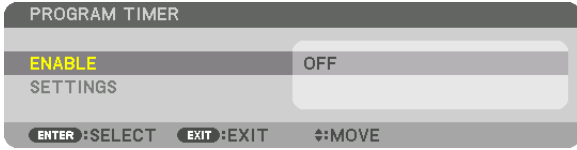

This option turns on/standby the projector and changes video signals automatically at a specified time.

NOTE:

- Before using [PROGRAM TIMER], make sure that the [DATE AND TIME] feature is set. (→ page 119)
 Make sure that the projector is in the standby condition with the POWER cable connected.
 The projector has a built-in clock. The clock will keep working for about a month after the main power is turned off. If the main power is not supplied to the projector for a month or more, it requires to set [DATE AND TIME SETTINGS] feature again.

Setting a new program timer

1. On the PROGRAM TIMER screen, use the ▲ or ▼ button to select [SETTINGS] and press the ENTER button.

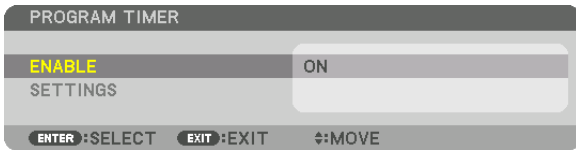

The [PROGRAM LIST] screen will be displayed.

2. Select a blank program number and press the ENTER button.



The [EDIT] screen will be displayed.

3. Make settings for each item as required.

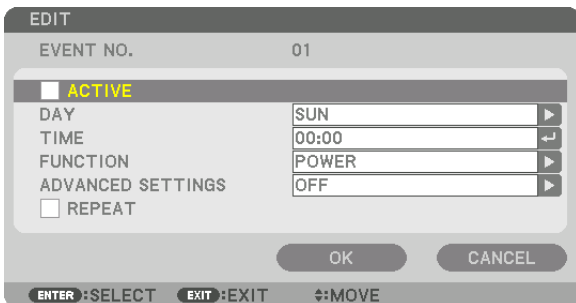

ACTIVE Place a check mark to enable the program.

DAY..... Select days of the week for the program timer. To execute the program from Monday to Friday, select [MON-FRI]. To execute the program in everyday basis, select [EVERYDAY].

5. Using On-Screen Menu

TIME Set the time to execute the program. Enter time in 24-hour format.

FUNCTION Select a function to be executed. Selecting [POWER] will allow you to turn on or off the projector by setting [ADVANCED SETTINGS]. Selecting [INPUT] will allow you to select an input terminal by setting [ADVANCED SETTINGS].

ADVANCED SETTINGS

..... Select one option for the selected item in [FUNCTION].

REPEAT..... Place a check mark to repeat the program continuing basis. To use the program this week only, clear the check mark.

4. Select [OK] and press the ENTER button.

This will complete the settings.

You will be returned to the [PROGRAM LIST] screen.

5. Select [(BACK)] and press the ENTER button.



You will be returned to the [PROGRAM TIMER] screen.

6. Select [EXIT] and press the ENTER button.

You will be returned to the [TOOLS] screen.

NOTE:

- Up to 30 different timer settings can be programmed.
- The Program Timer is executed on a set time basis, not in a program basis.
- Once the program not marked with a check in [REPEAT] has been executed, the check mark in the [ACTIVE] check box will be cleared automatically and the program will be disabled.
- When the on-time and the off-time set for the same time, the off-time setting will take preference.
- When two different sources are set for the same time, the larger program number will take preference.
- The on-time setting will not be executed while the cooling fans are running or an error is occurring.
- If the off-time setting is expired under the condition in which the power off is not possible, the off-timer setting will not be executed until the power off becomes possible.
- Programs not marked with a check mark in [ACTIVE] of the [EDIT] screen will not be executed even if the Program Timer is enabled.
- When the projector is turned on by using the program timer and if you want to turn off the projector, set the off-time or do it manually so as not to leave the projector on for a long period of time.

Activating the program timer

1. Select **[ENABLE]** on the **[PROGRAM TIMER]** screen and press the **ENTER** button.

The selection screen will be displayed.

2. Press the **▼** button to align the cursor with **[ON]** and then press the **ENTER** button.

Return to the [PROGRAM TIMER] screen.

NOTE:

- When the effective settings of the **[PROGRAM TIMER]** have not been set to **[ON]**, the program will not be executed even if the **[ACTIVE]** items in the program list have been ticked.
 - Even when the effective settings of the **[PROGRAM TIMER]** are set to **[ON]**, the **[PROGRAM TIMER]** will not work until the **[PROGRAM TIMER]** screen is closed.
-

Editing the programmed settings

1. On the **[PROGRAM LIST]** screen, select a program you want to edit and press the **ENTER** button.

2. Change the settings on the **[EDIT]** screen.

3. Select **[OK]** and press the **ENTER** button.

The programmed settings will be changed.

You will be returned to the [PROGRAM LIST] screen.

Changing the order of programs

1. On the **[PROGRAM LIST]** screen, select a program whose order you want to change and press the **►** button.

2. Press the **▼** button to select **▲** or **▼**.

3. Press the **ENTER** button a few times to select a row to which you wish to move the program.

The order of the programs will be changed.

Deleting the programs

1. On the **[PROGRAM LIST]** screen, select a program number you want to delete and press the **►** button.

2. Press the **▼** button to select **[ (DELETE)]**.

3. Press the **ENTER** button.

The confirmation screen will be displayed.

4. Select **[YES]** and press the **ENTER** button.

The program will be deleted.

This will complete deleting the program.

DATE AND TIME SETTINGS

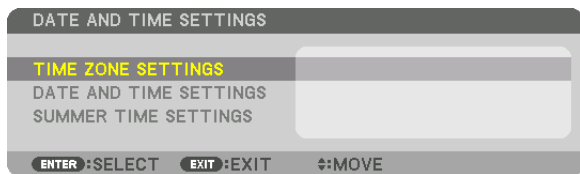

You can set the current time, month, date, and year.

NOTE: The projector has a built-in clock. The clock will keep working for about a month after the main power is turned off. If the main power is off for a month or more, the built-in clock will cease. If the built-in clock ceases, set the date and time again. The built-in clock will not cease while in the standby mode. In order to activate the built-in clock continuously even when the projector is not used, leave it in the standby state not plugging off the power cable.

TIME ZONE SETTINGS..... Select your time zone.

DATE AND TIME SETTINGS Set your current date (MM/DD/YYYY) and time (HH:MM).

INTERNET TIME SERVER: If you place a check mark, the projector's built-in clock will be synchronized with an Internet time server in every 24 hours and at the time of projector's startup.

UPDATE: Synchronizes the projector's built-in clock immediately. The UPDATE button is not available unless the INTERNET TIME SERVER check box is turned on.

SUMMER TIME SETTINGS If you place a check mark, the clock for daylight saving will be enabled.

Disabling the Cabinet Buttons [CONTROL PANEL LOCK]

This option turns on or off the CONTROL PANEL LOCK function.

NOTE:

- How to cancel the [CONTROL PANEL LOCK]
When the [CONTROL PANEL LOCK] is set to [ON], press the KEY LOCK button on the cabinet for 1 second or longer to cancel the [CONTROL PANEL LOCK] setting.

TIP:

- When the [CONTROL PANEL LOCK] is turned on, a key lock icon [] will be displayed at the bottom right of the menu.
- This CONTROL PANEL LOCK does not affect the remote control functions.

[NOTIFICATION SETTINGS]

This setting is to enable/disable the notification by the buzzer and rear LED (Light status indicator/System status indicator).

REAR LED	OFF	[REAR LED] is deactivated.
	ON	The [REAR LED] informs you of the unit's status just like the status indicator.
BUZZER	OFF	The buzzer goes off
	ON	The buzzer stops.

Enabling Security [SECURITY]

This feature turns on or off the SECURITY function.

Unless the correct keyword is entered, the projector cannot project an image. (→ page 45)

NOTE: Your setting will not be affected even when [RESET] is done from the menu.

Selecting Communication Speed [COMMUNICATION SPEED]

This feature sets the communication speed for the PC Control port (D-Sub 9P). Make sure to set the appropriate speed for the device to connect.

NOTE:

- Select [38400bps] or less when using our utility software "NaViSet Administrator 2".
- Your selected communication speed will not be affected even when [RESET] is done from the menu.

Setting ID to the Projector [CONTROL ID]

You can operate multiple projectors separately and independently with the single remote control that has the CONTROL ID function. If you assign the same ID to all the projectors, you can conveniently operate all the projectors together using the single remote control. To do so, you have to assign an ID number to each projector.

CONTROL ID NUMBER..... Select a number from 1 to 254 you wish to assign to your projector.

CONTROL ID..... Select [OFF] to turn off the CONTROL ID setting and select [ON] to turn on the CONTROL ID setting.

NOTE:

- When [ON] is selected for [CONTROL ID], the projector cannot be operated by using the remote control that does not support the CONTROL ID function. (In this case the buttons on the projector cabinet can be used.)
- Your setting will not be affected even when [RESET] is done from the menu.
- Pressing and holding the ENTER button on the projector cabinet for 10 seconds will display the menu for canceling the Control ID.

Assigning or Changing the Control ID

1. Turn on the projector.

2. Press the ID SET button on the remote control.

The CONTROL ID screen will be displayed.



If the projector can be operated with the current remote control ID, the [ACTIVE] will be displayed. If the projector cannot be operated with the current remote control ID, the [INACTIVE] will be displayed. To operate the inactive projector, assign the control ID used for the projector by using the following procedure (Step 3).

3. Press one of numeric keypad buttons while pressing and holding the ID SET button on the remote control.

Example:

To assign "3", press the "3" button on the remote control.

No ID means that all the projectors can be operated together with a single remote control. To set "No ID", enter "000" or press the CLEAR button.

TIP: The range of IDs is from 1 to 254.

4. Release the ID SET button.

The updated CONTROL ID screen will be displayed.

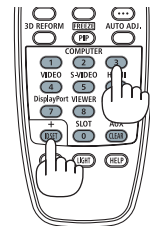

NOTE:

- The IDs can be cleared in a few days after the batteries are run down or removed.
- Accidentally pressing any one of the buttons of the remote control will clear currently specified ID with batteries removed.

Turning On or Off Remote Sensor [REMOTE SENSOR]

This option determines which remote sensor on the projector is enabled in wireless mode. The options are: FRONT/BACK, FRONT, BACK, and HDBaseT*.

NOTE:

- *The remote control of the projector will not be able to receive signals if the power supply of the HDBaseT transmission device connected to the projector is switched on when this has been set to "HDBaseT".*
-

TIP:

- *If the remote control system does not function when direct sunlight or strong illumination strikes the remote control sensor of the projector, change to other option.*

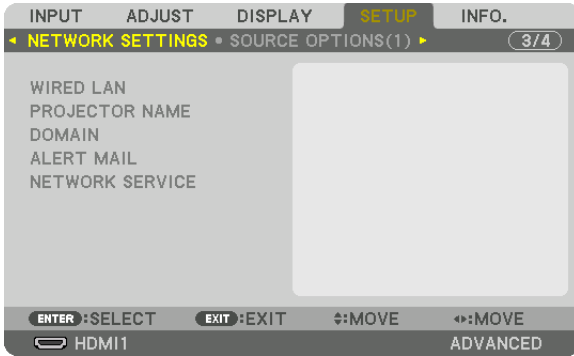
[NETWORK SETTINGS]*Important:*

- Consult with your network administrator about these settings.
- When using a wired LAN, connect the Ethernet cable (LAN cable) to the LAN port or HDBaseT port on the projector. (→ page 10)
- Please use a shielded twisted pair (STP) cable of Category 5e or higher for the LAN cable (sold commercially).

TIP: The network settings you make will not be affected even when [RESET] is done from the menu.

Hints on How to Set Up LAN Connection**To set up the projector for a LAN connection:**

Select [WIRED LAN] → [PROFILES] → [PROFILE 1] or [PROFILE 2].

Two settings can be set for wired LAN.

Next turn on or off for [DHCP], [IP ADDRESS], [SUBNET MASK], and [GATEWAY] and select [OK] and press the ENTER button. (→ page 123)

To recall LAN settings stored in the profile number:

Select [PROFILE 1] or [PROFILE 2] for wired LAN, and then select [OK] and press the ENTER button. (→ page 123)

To connect a DHCP server:

Turn on [DHCP] for wired LAN. Select [ON] and press the ENTER button. To specify IP address without using the DHCP server, turn off [DHCP]. (→ page 123)

To receive error messages via e-mail:

Select [ALERT MAIL], and set [SENDER'S ADDRESS], [SMTP SERVER NAME], and [RECIPIENT'S ADDRESS]. Last, select [OK] and press the ENTER button. (→ page 125)

WIRED LAN

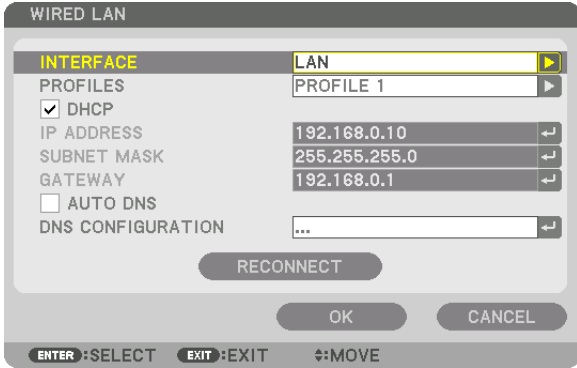

INTERFACE	To configure the LAN port, select [LAN]. To configure the HDBaseT port, select[HDBaseT].	—
PROFILES	<ul style="list-style-type: none"> The settings for the wired LAN can be recorded in the projector memory in two ways. Select [PROFILE 1] or [PROFILE 2] and then do settings for [DHCP] and the other options. After doing this, select [OK] and press the ENTER button. This will store your settings in memory. To recall the settings from memory: After selecting [PROFILE 1] or [PROFILE 2] from the [PROFILES] list. Select [OK] and press the ENTER button. 	—
DHCP	Place a check mark to automatically assign an IP address to the projector from your DHCP server. Clear this check box to register the IP address or subnet mask number obtained from your network administrator.	—
IP ADDRESS	Set your IP address of the network connected to the projector when [DHCP] is turned off. <i>NOTE:</i> <ul style="list-style-type: none"> System IP addresses such as 192.168.254.XXX cannot be set. 	Up to 12 numeric characters
SUBNET MASK	Set your subnet mask number of the network connected to the projector when [DHCP] is turned off.	Up to 12 numeric characters
GATEWAY	Set the default gateway of the network connected to the projector when [DHCP] is turned off.	Up to 12 numeric characters
AUTO DNS	Place a check mark to automatically assign the IP address of your DNS server connected to the projector from your DHCP server. Clear this check box to set the IP address of your DNS server connected to the projector. AUTO DNS can be set for the HDBaseT port only.	Up to 12 numeric characters
DNS CONFIGURATION	Set the IP address of your DNS server on the network connected to the projector when [AUTO DNS] is cleared.	Up to 12 numeric characters
RECONNECT	Retry to connect the projector to a network. Try this if you have changed [PROFILES].	—

PROJECTOR NAME

PROJECTOR NAME	Set a unique projector name.	Up to 16 alphanumeric characters and symbols
----------------	------------------------------	--

DOMAIN

Set a host name and domain name of the projector.

HOST NAME	Set a host name of the projector.	Up to 16 alphanumeric characters
DOMAIN NAME	Set a domain name of the projector.	Up to 60 alphanumeric characters

ALERT MAIL

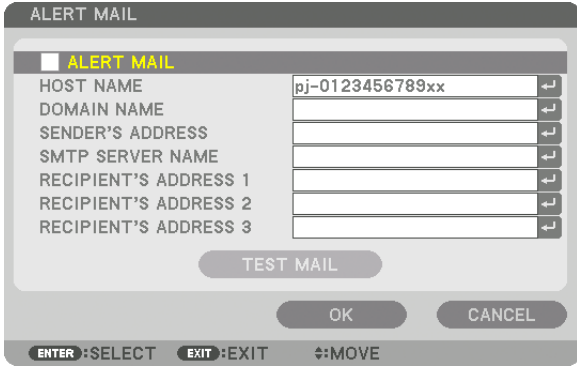

ALERT MAIL	<p>This option will notify your computer of error messages via e-mail when using wireless or wired LAN.</p> <p>Placing a checkmark will turn on the Alert Mail feature.</p> <p>Clearing a checkmark will turn off the Alert Mail feature.</p> <p>Sample of a message to be sent from the projector:</p> <div style="border: 1px solid black; padding: 5px;"> <p>Subject: [Projector] Projector Information THE COOLING FAN HAS STOPPED. [INFORMATION] PROJECTOR NAME: xxxxx LIGHT HOURS USED: xxxxx[H]</p> </div>	—
HOST NAME	Type in a host name.	Up to 16 alphanumeric characters
DOMAIN NAME	Type in a domain name of the network connected to the projector.	Up to 60 alphanumeric characters
SENDER'S ADDRESS	Specify the sender's address.	Up to 60 alphanumeric characters and symbols
SMTP SERVER NAME	Type in the SMTP server name to be connected to the projector.	Up to 60 alphanumeric characters
RECIPIENT'S ADDRESS 1, 2, 3	Type in your recipient's address.	Up to 60 alphanumeric characters and symbols
TEST MAIL	<p>Send a test mail to check if your settings are correct.</p> <p><i>NOTE:</i></p> <ul style="list-style-type: none"> • If you entered an incorrect address in a test, you may not receive an Alert mail. Should this happen, check if the Recipient's Address is correctly set. • Unless any one of the [SENDER'S ADDRESS], [SMTP SERVER'S NAME] or [RECIPIENT'S ADDRESS 1-3] is selected, [TEST MAIL] is not available. • Be sure to highlight [OK] and press the ENTER button before executing [TEST MAIL]. 	—

NETWORK SERVICE

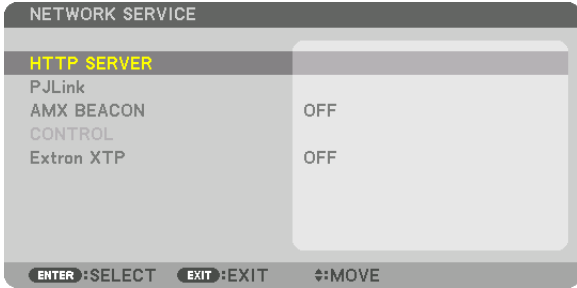

HTTP SERVER	Set a password for your HTTP server.	Up to 10 alphanumeric characters
PJLink	<p>Configure the settings for using PJLink. To use this function, connect the LAN cable to the HDBaseT port.</p> <p>PASSWORD Set the password.</p> <p>CLASS To use functions with PJLink Class 2 specifications, set [CLASS 2].</p> <p>DESTINATION When the CLASS is set to "CLASS 2", input the IP address of the destination.</p> <hr/> <p>NOTE:</p> <ul style="list-style-type: none"> • Do not forget your password. However, if you forget your password, consult with your distributor. • What is PJLink? PJLink is a standardization of protocol used for controlling projectors of different manufacturers. This standard protocol is established by Japan Business Machine and Information System Industries Association (JBMA) in 2005. The projector supports all the commands of PJLink Class 1. • Setting of PJLink will not be affected even when [RESET] is done from the menu. 	Up to 32 alphanumeric characters
AMX BEACON	<p>Turn on or off for detection from AMX Device Discovery when connecting to the network supported by AMX's NetLinx control system. To use this function, connect the LAN cable to the HDBaseT port.</p> <p>TIP: When using a device that supports AMX Device Discovery, all AMX NetLinx control system will recognize the device and download the appropriate Device Discovery Module from an AMX server.</p> <p>ON will enable detecting the projector from AMX Device Discovery. OFF will disable detecting the projector from AMX Device Discovery.</p>	—
Extron XTP	<p>Set for connecting this projector to the Extron XTP transmitter. To use this function, connect the LAN cable to the HDBaseT port.</p> <p>ON will enable to connect with the XTP transmitter. OFF will disable to connect with the XTP transmitter.</p>	—

[SOURCE OPTIONS(1)]

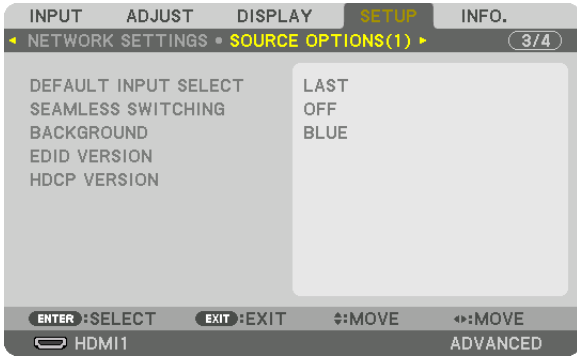

Selecting Default Source [DEFAULT INPUT SELECT]

You can set the projector to default to any one of its inputs each time the projector is turned on.

- LAST Sets the projector to default to the previous or last active input each time the projector is turned on.
- AUTO Searches for an active source in order of HDMI1 → HDMI2 → DisplayPort1 → DisplayPort2 → HDBaseT → SDI1 → SDI2 → SDI3 → SDI4 → SLOT and displays the first found source.
- HDMI1 Displays the digital source from the HDMI 1 IN connector every time the projector is turned on.
- HDMI2 Displays the digital source from the HDMI 2 IN connector every time the projector is turned on.
- DisplayPort1 Displays the digital source from the DisplayPort1 IN connector every time the projector is turned on.
- DisplayPort2 Displays the digital source from the DisplayPort2 IN connector every time the projector is turned on.
- HDBaseT Project the HDBaseT signal.
- SDI1 Displays the digital source from the SDI1 IN terminal every time the projector is turned on.
- SDI2 Displays the digital source from the SDI2 IN terminal every time the projector is turned on.
- SDI3 Displays the digital source from the SDI3 IN terminal every time the projector is turned on.
- SDI4 Displays the digital source from the SDI4 IN terminal every time the projector is turned on.
- SLOT Displays the picture via the optional board (sold separately) inserted into the SLOT.

[SEAMLESS SWITCHING]

When the input connector is switched, the image displayed before switching is held to switch to the new image without a break due to absence of a signal.

NOTE:

- This function will not perform properly when the input signal is selected to a value other than 60/30 Hz for vertical frequency.

Selecting a Color or Logo for Background [BACKGROUND]

Use this feature to display a blue/black screen or logo when no signal is available. The default background is [BLUE].

NOTE:

- To change the image displayed as the logo, see page 162.

[EDID VERSION]

Switch the EDID version for the HDMI 1 IN and HDMI 2 IN terminals.

- MODE1 Supports general signal
- MODE2 Supports 4K signal
 Select this mode for displaying 4K image using the device supporting 4K

NOTE:
 If image and sound can not be output in [MODE2], switch to [MODE1].

[HDCP VERSION]

Switch the HDCP version for the HDMI 1 IN, HDMI 2 IN and HDBaseT IN/Ethernet terminals.

- HDCP2.2 Automatically switch the mode HDCP2.2 and HDCP1.4
- HDCP1.4 Forcedly perform transmission with HDCP1.4

[SOURCE OPTIONS(2)]

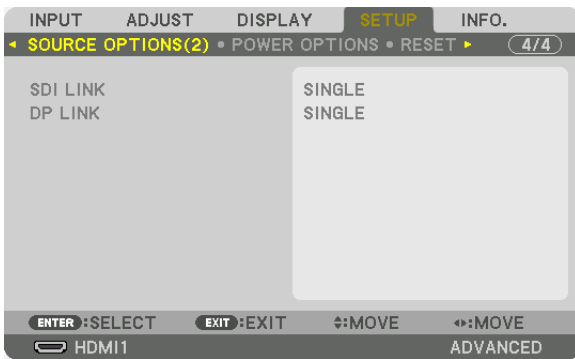

[SDI LINK]

Select the display method of the signal input to the SDI1/SDI2/SDI3/SDI4 input terminal.
 Set [QUAD] to display 4K signals with four SDI connections.

- SINGLE Set the SDI1 input and SDI2 input and SDI3 input and SDI4 input to the respective single link (one input signal is displayed as one image).
- QUAD Set the SDI1 input and SDI2 input and SDI3 input and SDI4 input to quad link (the four input signals are displayed as one image). Select when the transmission format is set to Square Division.
- QUAD(2SI) Set the SDI1 input and SDI2 input and SDI3 input and SDI4 input to quad link (the four input signals are displayed as one image). Select when the transmission format is set to 2 Sample Interleave.
- DUAL Dual display with SDI1 input and SDI 2 input.

NOTE:
 To display images in the quad link, quad (2SI) link, or dual link mode, select the SDI1 input.

[DP LINK]

Select the display method of the signal input to the DisplayPort1/DisplayPort2 input terminal.

- SINGLE Set the DisplayPort1 input and DisplayPort2 input to the respective single link (one input signal is displayed as one image).
- DUAL Dual display with DisplayPort1 input and DisplayPort1 input.

NOTE:
 To display images in the dual link mode, select the DisplayPort 1 input.

[POWER OPTIONS]

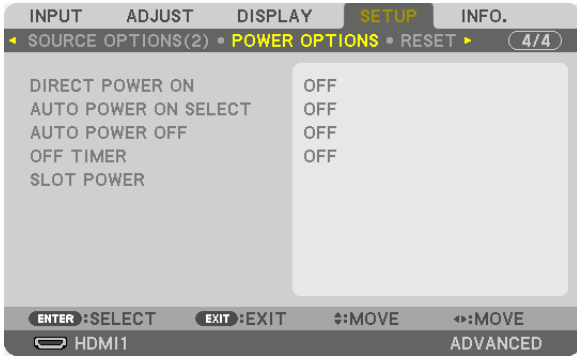

Enabling Direct Power On [DIRECT POWER ON]

Turns the projector on automatically when the power cable is inserted into an active power outlet. This eliminates the need to always use the POWER button on the remote control or projector cabinet.

Turning On the Projector by Detecting Input Signal [AUTO POWER ON SELECT]

Under the state of standby, the projector automatically detects and projects synchronizing signal input from the selected terminals by this function.

- OFF AUTO POWER ON SELECT function becomes inactive.
- HDMI1, HDMI2, DisplayPort1, DisplayPort2, HDBaseT, SDI1, SDI2, SDI3, SDI4, SLOT
 When the projector detects the computer signal input from the selected terminal, automatically it will be turned ON and will project the computer screen.

NOTE:

- *If you want to activate this AUTO POWER ON SELECT function after powering OFF the projector, interrupt signal from input terminals or pull out the computer cable from the projector and wait for over 3 seconds and then input signal from the selected terminal.*

Enabling Power Management [AUTO POWER OFF]

When this option is selected you can enable the projector to automatically turn off (at the selected time: 0:05, 0:10, 0:15, 0:20, 0:30, 1:00) if there is no signal received by any input or if no operation is performed.

Using Off Timer [OFF TIMER]

1. **Select your desired time between 30 minutes and 16 hours: OFF, 0:30, 1:00, 2:00, 4:00, 8:00, 12:00, 16:00.**
2. **Press the ENTER button on the remote control.**
3. **The remaining time starts counting down and it is displayed at the bottom of the On-Screen Menu.**
4. **The projector will turn off after the countdown is complete.**

NOTE:

- *To cancel the preset time, set [OFF] for the preset time or turn off the power.*
 - *When the remaining time reaches 3 minutes before the projector is turned off, the [THE PROJECTOR WILL TURN OFF WITHIN 3 MINUTES] message will be displayed on the bottom of the screen.*
-

Setting for the Optional Board [SLOT POWER]

When using the optional board installed in the slot, set the following options.

PROJECTOR ON This feature will turn on or off the power to the optional board.

OFF: Forcibly turn off the power to the optional board installed in the slot.

ON: Turn on the power to the optional board installed in the slot.

PROJECTOR STANDBY

..... This feature will automatically enable or disable the optional board installed in the slot when the projector is in standby.

DISABLE: Select this option to disable the optional board in the projector standby.

ENABLE: Select this option to enable the optional board in the projector standby.

Returning to Factory Default [RESET]

The RESET feature allows you to change adjustments and settings to the factory preset for a (all) source (s) except the following:

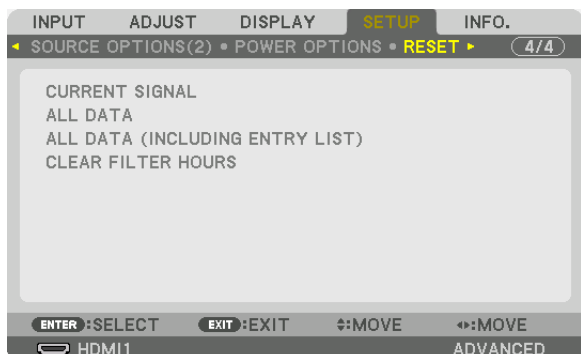

[CURRENT SIGNAL]

Resets the adjustments for the current signal to the factory preset levels.

NOTE:

- Adjustment values of a signal locked in ENTRY LIST cannot be reset.
-

[ALL DATA]

Reset all the adjustments and settings for all the signals to the factory preset.

All items can be reset **EXCEPT** [ENTRY LIST], [GEOMETRIC CORRECTION], [EDGE BLENDING], [PICTURE SETTING], [MULTI SCREEN], [LANGUAGE], [FILTER MESSAGE], [SCREEN TYPE], [FAN MODE], [REF. WHITE BALANCE], [STATIC CONVERGENCE], [REF. LENS MEMORY], [ADMINISTRATOR MODE], [DATE AND TIME SETTINGS], [CONTROL PANEL LOCK], [SECURITY], [COMMUNICATION SPEED], [CONTROL ID], [NETWORK SETTINGS], [BACKGROUND], [EDID VERSION], [HDCP VERSION], [SDI LINK], [DP LINK], [OFF TIMER], [LIGHT HOURS USED], [FILTER HOURS USED], [LOW FAN MODE HOURS USED].

[ALL DATA (INCLUDING ENTRY LIST)]

Reset all the adjustments and settings for all the signals including the [ENTRY LIST] to the factory preset except [GEOMETRIC CORRECTION], [EDGE BLENDING], [PICTURE SETTING], [MULTI SCREEN], [LANGUAGE], [FILTER MESSAGE], [SCREEN TYPE], [FAN MODE], [REF. WHITE BALANCE], [STATIC CONVERGENCE], [REF. LENS MEMORY], [ADMINISTRATOR MODE], [DATE AND TIME SETTINGS], [CONTROL PANEL LOCK], [SECURITY], [COMMUNICATION SPEED], [CONTROL ID], [NETWORK SETTINGS], [BACKGROUND], [EDID VERSION], [HDCP VERSION], [SDI LINK], [DP LINK], [OFF TIMER], [LIGHT HOURS USED], [FILTER HOURS USED], [LOW FAN MODE HOURS USED].

Also deletes all the signals in the [ENTRY LIST] and returns to the factory preset.

NOTE: Locked signals in Entry List cannot be reset.

Clearing the Filter Usage Hours [CLEAR FILTER HOURS]

Resets the filter usage back to zero. Selecting this option displays submenu for a confirmation. Select [YES] and press the ENTER button.

The [OFF] item is selected for [FILTER MESSAGE] at the time of shipment. When [OFF] is selected, you do not need to clear the filter usage hour.

NOTE: Elapsed time of the filter use will not be affected even when [RESET] is done from the menu.

8 Menu Descriptions & Functions [INFO.]

Displays the status of the current signal and light module usage. This item has ten pages. The information included is as follows:

TIP: Pressing the HELP button on the remote control will show the [INFO.] menu items.

[USAGE TIME]

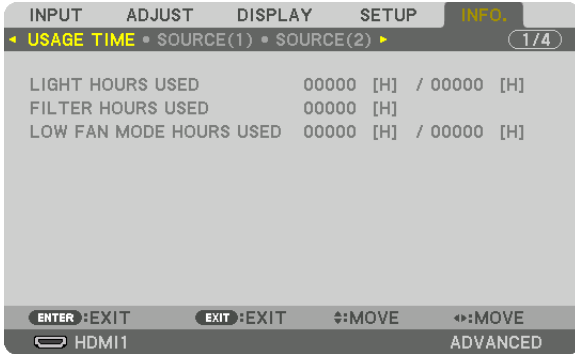

- [LIGHT HOURS USED] (H)
- [FILTER HOURS USED] (H)
- [LOW FAN MODE HOURS USED] (H)

[SOURCE(1)]

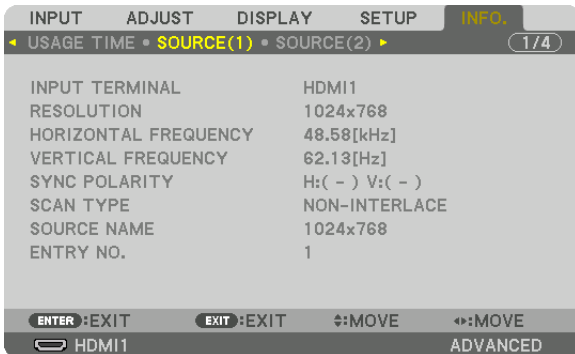

- INPUT TERMINAL
- HORIZONTAL FREQUENCY
- SYNC POLARITY
- SOURCE NAME

- RESOLUTION
- VERTICAL FREQUENCY
- SCAN TYPE
- ENTRY NO.

[SOURCE(2)]

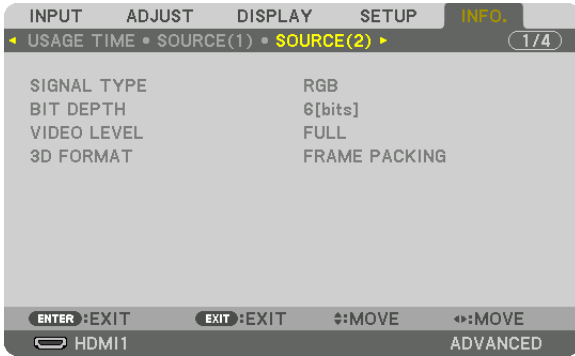

SIGNAL TYPE
VIDEO LEVEL

BIT DEPTH
3D FORMAT

[WIRED LAN(1)]

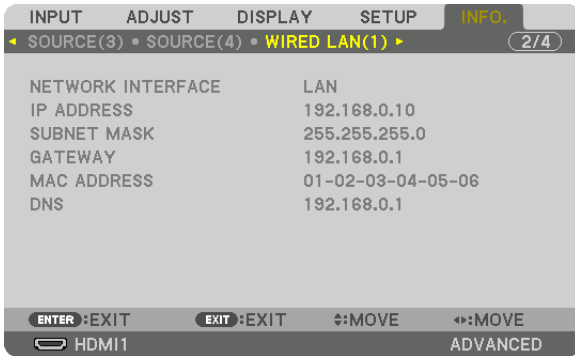

NETWORK INTERFACE
SUBNET MASK
MAC ADDRESS

IP ADDRESS
GATEWAY
DNS

[WIRED LAN(2)]

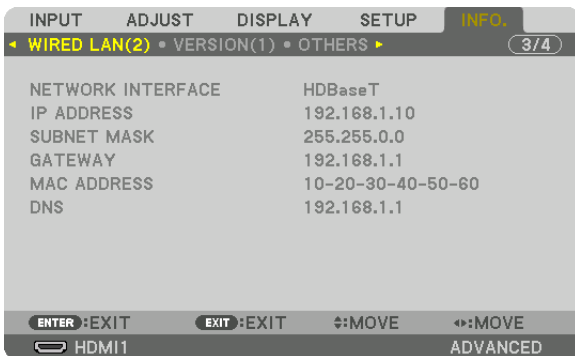

NETWORK INTERFACE
SUBNET MASK
MAC ADDRESS

IP ADDRESS
GATEWAY
DNS

[VERSION(1)]

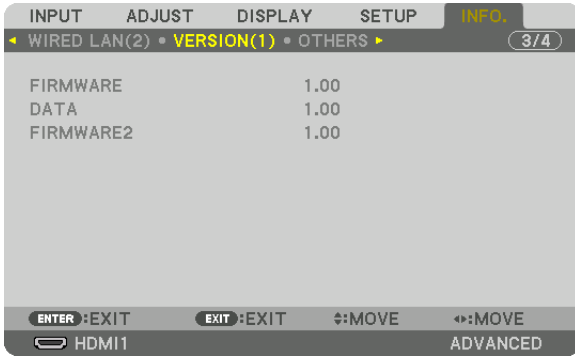

FIRMWARE
FIRMWARE2

DATA

[OTHERS]

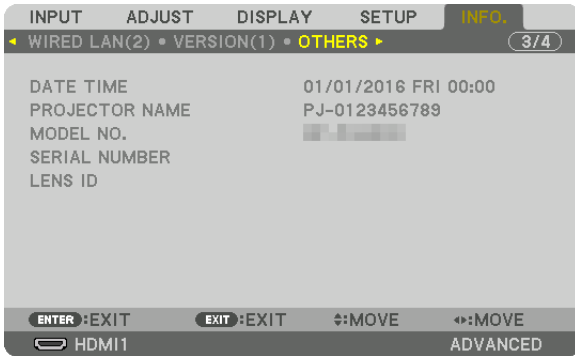

DATE TIME
MODEL NO.
LENS ID

PROJECTOR NAME
SERIAL NUMBER

[CONDITIONS]

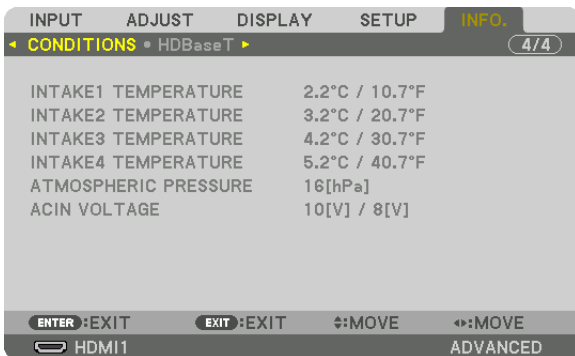

INTAKE TEMPERATURE1
INTAKE TEMPERATURE3
ATMOSPHERIC PRESSURE

INTAKE TEMPERATURE2
INTAKE TEMPERATURE4
ACIN VOLTAGE

[HDBaseT]

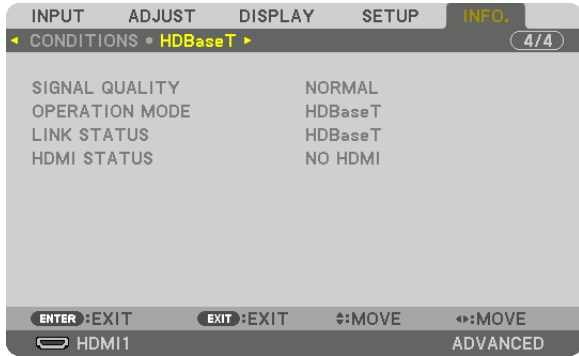

SIGNAL QUALITY
LINK STATUS

OPERATION MODE
HDMI STATUS

6. Connecting to Other Equipment

Below is an example of connections to external equipment.

No connection cables are included with this unit. Use the appropriate cables for the connections.



CAUTION

For HDMI, DisplayPort, BNC and LAN, please use a shielded cable.

Use of other cables may cause interference with radio and television reception.

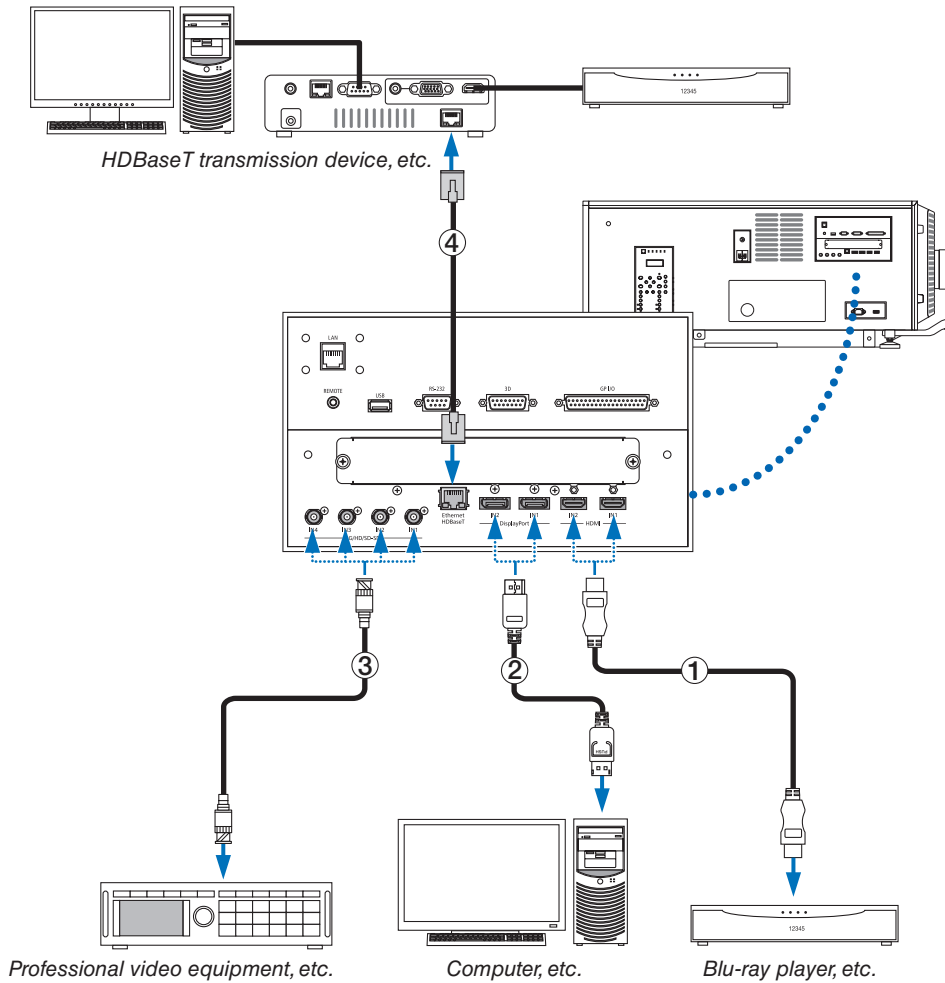

① HDMI cable (not supplied)

- Use a certified High Speed HDMI® Cable or High Speed HDMI® Cable with Ethernet.
- When connecting the HDMI 1 IN or HDMI 2 IN connector of the projector to the Blu-ray player, the projector's video level can be made settings in accordance with the Blu-ray player's video level. In the menu select [ADJUST] → [VIDEO] → [VIDEO LEVEL] and make necessary settings.

② DisplayPort cable (not supplied)

- Use a certified DisplayPort cable.



③ BNC cable (not supplied)

- Use cables that are 5C-FB or higher (5C-FB, 7C-FB, etc.) or Belden 1694A or higher. In addition, use cables with a cable length 100m or less.
- The length of cables that can be used may differ, depending on the signal.

④ LAN cable (not supplied)

- Please use a shielded twisted pair (STP) cable of Category 5e or higher for the LAN cable (sold commercially).
- The HDBaseT port of the projector supports HDMI signals (HDCP) from transmission devices, control signals from external devices (serial, LAN) and remote control signals (IR commands).
- The maximum transmission distance over the LAN cable is 100 m. (the maximum distance is 70 m for a 4K signal)
- Please do not use other transmission equipment between the projector and transmission equipment. The picture quality may be degraded as a result.
- This projector is not guaranteed to work with all HDBaseT transmission devices sold commercially.

After turning on the power of the unit, select the input according to the connection terminal.

Input connector	Button on the projector cabinet	Button on the remote control	Note
HDMI1/2 IN	HDMI	HDMI	Switches between HDMI1 and HDMI2 each time it is pressed.
DisplayPort 1/2 IN	DisplayPort	DisplayPort	<ul style="list-style-type: none"> • Switches between DisplayPort1 and DisplayPort2 each time it is pressed. • Select DisplayPort1 for dual link.
SDI 1/2/3/4 IN	3G/HD/SD-SDI	AUX	<ul style="list-style-type: none"> • Switches between SDI1, SDI2, SDI3 and SDI4 each time it is pressed. • Select SDI1 for quad link or dual link.
HDBaseT	HDBaseT	NETWORK	—

7. Maintenance

NOTE

- Please request your distributor to perform cleaning of the projector inside.
-

① Cleaning the Cabinet

 **WARNING**

- Please do not use a spray containing flammable gas to remove dust attached to the cabinet, etc. Doing so may result in fires.

Be sure to always check that the AC power supply of the projector is disconnected before carrying out maintenance of the projector.

- Wipe with a dry, soft cloth without nap.
When the cabinet is excessively dirty, wipe with cloth well wrung after being dampened with a neutral detergent diluted with water and then finish up with a dry cloth.
When you use a chemical dust cloth, follow the instructions in the manual attached to it.
- Do not use a solvent, such as thinner or benzene. The coating may deteriorate or peel off.
- When removing dust on the ventilation opening, suck it off using an adapter with a brush on a vacuum cleaner. Never allow the cleaner without an adapter to come into direct contact or use a nozzle adapter in cleaning.
- Clean the ventilation opening at regular intervals. Dust, if allowed to accumulate there, may cause heating inside, which leads to functional trouble. The interval, which can vary with the location of your projector, is about 100 hours.
- Do not damage the cabinet by scratching it or allowing hard objects to hit it. This can scratch the projector.
- Consult your dealer/distributor about cleaning the inside of the projector.

NOTE

- Do not allow insecticide or other volatile liquid to splash on the cabinet, lens or screen. Also, do not allow any rubber or plastic object to remain in contact with the cabinet for a long time. The coating may deteriorate or peel off.
-

② Cleaning the Lens

Clean the lens the same way as with camera lens (using a commercially available camera blower or cleaning paper for glasses). Take care not to damage the lens when cleaning.

 **WARNING**

- Do not look into the light source while the projector is ON. Strong light is emitted from the projector and visual impairment could result.
- Please do not use a spray containing flammable gas to remove dust attached to the lens, etc. Doing so may result in fires.

 **CAUTION**

- Before cleaning the lens, first turn off the power, make sure the cooling fan has completely stopped, then turn off the AC power. Make sure the unit has cooled down completely before cleaning the lens.

3 Cleaning the Air Filters

Air filters are attached over the air inlet of the projector to prevent dust. The air filters should be cleaned periodically in order to maintain projector performance.

WARNING

- Dust in air filters will hinder ventilation of the projector, lead to a rise of the internal temperature and can cause a fire or malfunction.
- Please do not use a spray containing flammable gas to remove dust attached to the filters, etc. Doing so may result in fires.

CAUTION

- Before cleaning the filter, first turn off the power, make sure the cooling fan has completely stopped, then turn off the AC power. Make sure the unit has cooled down completely before cleaning the filter. Removing the filter cover while the unit is running could result in burns or electric shock from contact with internal parts.

The unit uses a two layer metal-mesh filter installed behind the filter cover. With regular cleaning it can be used repeatedly.

When cleaning the air filter, clean it all at the same time.

Air inlet (Filter cover / Filter)

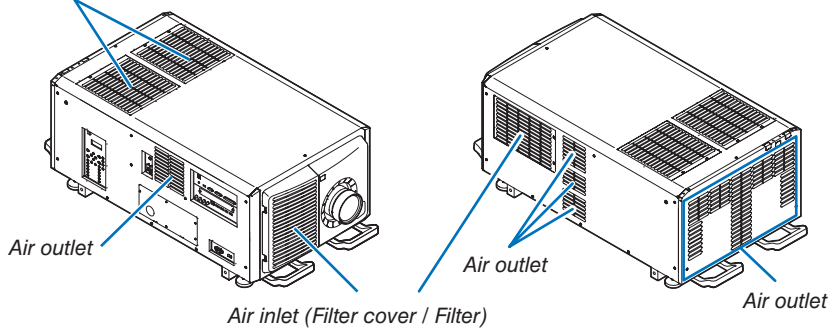

Cleaning the Air Filter

1. Remove the front filter cover.

Pull the front filter cover in the direction of the arrow to remove.

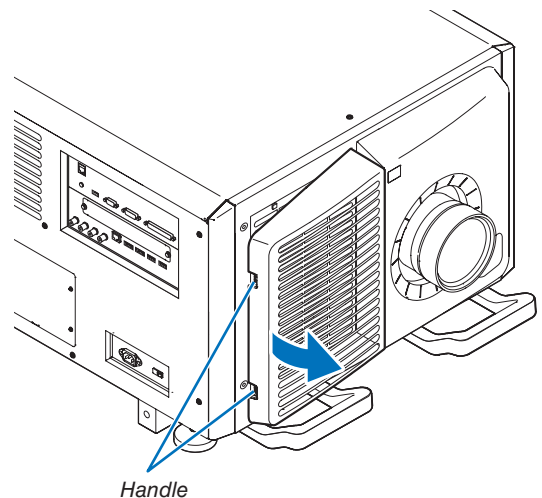

2. Remove the air filter.

(1) Press the stopper button (2 places).

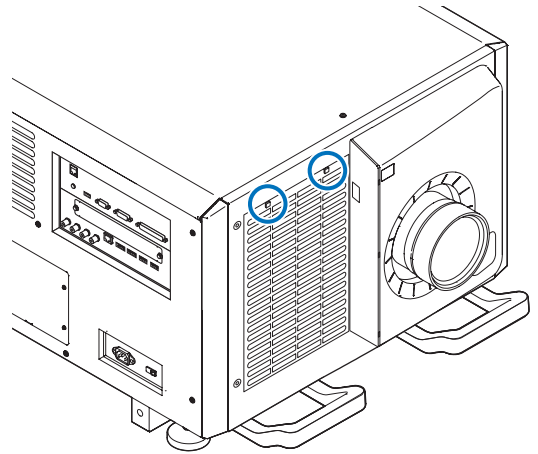

(2) Pull the top part of the air filter towards you. Once you have freed the upper half of the air filter, remove the filter by pulling it diagonally upwards.

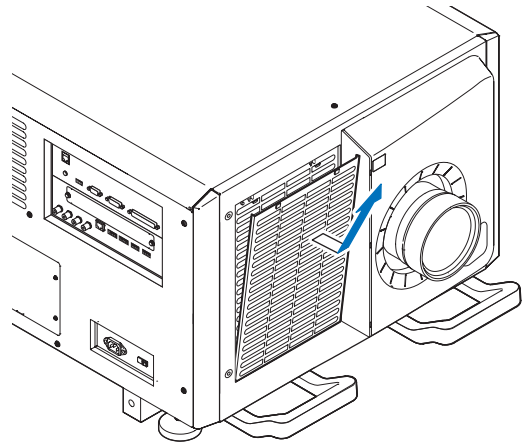

3. Lift the air filter in the direction of the arrow and remove it.

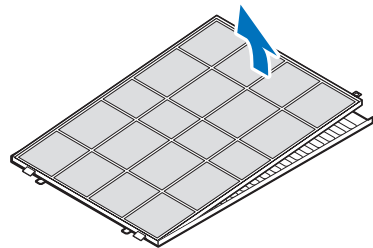

4. Remove the air filters.

(1) Slide the upper air filter to the position shown below.

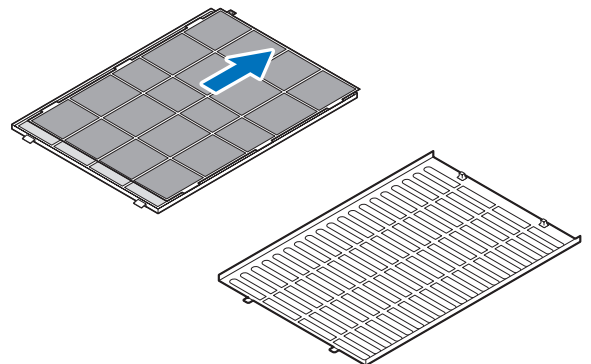

(2) Lift the upper air filter in the direction of the arrow and remove it.

NOTE

- Do not apply a high degree of force or attempt to pry it open. This could deform the flange making it impossible to reattach the filter cover.

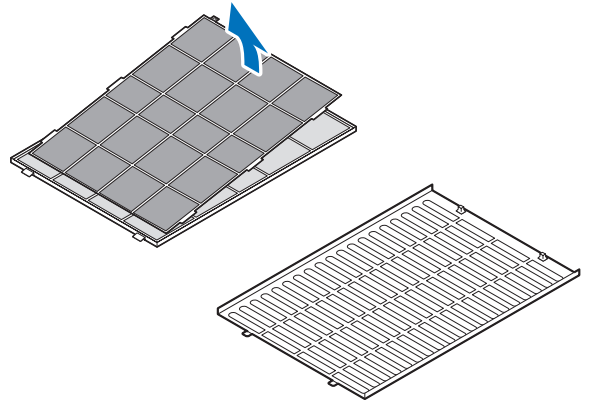

5. Clean all the dust from the filters using a vacuum cleaner.

(1) Carefully remove the dust from the filter covers as well as from both sides of all the filters.

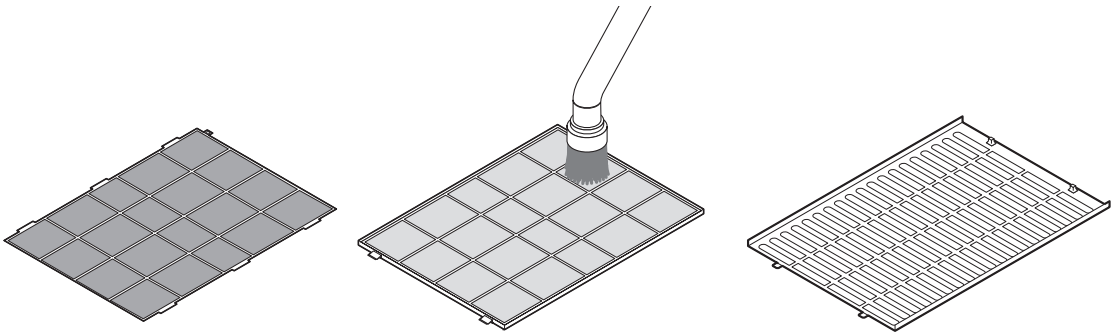

(2) Remove the dust from the grates on the outside of the projector as well.

Be sure to also remove any dust stuck to the louver (blind with angled horizontal slats) with a vacuum cleaner.

NOTE

- Whenever you vacuum the filter, use the soft brush attachment to vacuum. This is to avoid damage to the filter.
- Do not wash the filter with water. Doing so can result in damage to the filter membrane and also cause clogging.

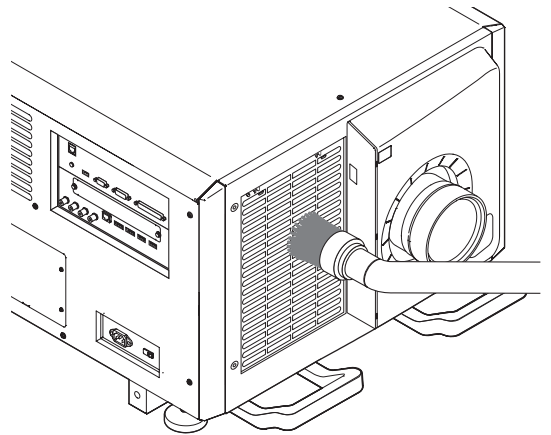

6. Put the various parts of the filter together and fit them inside the filter cover.

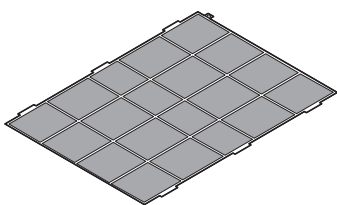

Coarse grade filter

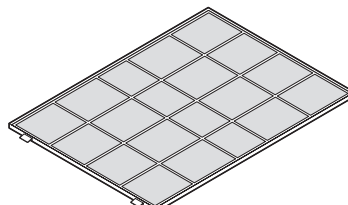

Fine grade filter

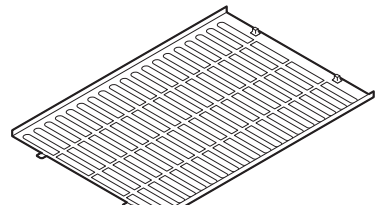

Filter cover

7. Fix the filter inside the projector unit.

- (1) Snap the filter cover tabs into the cutout portion of the projector unit to secure it.
- (2) Seat the air filter aligned with the air inlet.

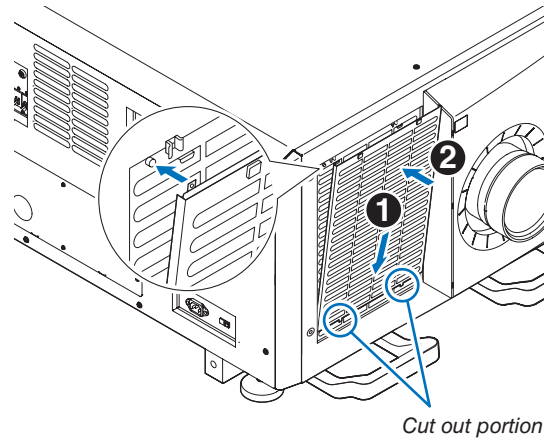

8. Attach the front filter cover.

- Push the front filter cover in the direction of the arrow to install.

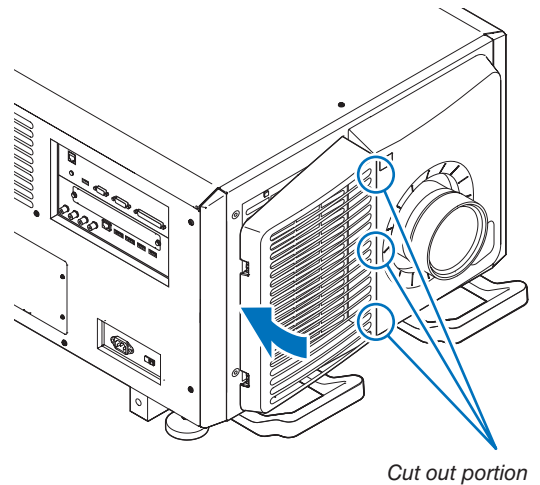

9. Clean the other intake vent air filters in the same way.

- Clean the other intake vent air filters in the same way as in steps (2) to (7).

NOTE

- Before turning on the power, make sure that all filter covers are in place. If they are not fitted properly dust could get inside the projector causing it to malfunction.
- Reset air filter usage time after cleaning the filters.

Resetting the Air Filter Usage Time

1. Turn on the power to the projector.
2. Select [SETUP] → [RESET] and perform [CLEAR FILTER HOURS].

This completes resetting the air filter usage time.

8. Appendix

① Throw distance and screen size

Seven separate bayonet style lenses can be used on this projector. Refer to the information on this page and use a lens suited for the installation environment (screen size and throw distance). For installation and replacement of lens units contact your distributor.

Each number provided in the table below means the throw distance between the lens surface and the screen.

Lens types and throw distance

4096 × 2160 (Aspect ratio: 17:9)

unit: inch

Screen size	Lens model name						
	L2K-10F1	L4K-11ZM	L4K-15ZM	L4K-20ZM	L2K-30ZM	L2K-43ZM1	L2K-55ZM1
100"	78.7	105.9–149.6	131.2–181.1	185.0–303.1	232.3–338.6	338.6–476.4	433.1–677.2
120"	94.5	128.0–181.1	158.4–220.5	216.5–362.2	279.5–409.4	405.5–574.8	519.7–818.9
150"	122.0	161.2–224.4	199.1–275.6	271.7–448.8	354.3–511.8	511.8–720.5	653.5–1027.6
200"	161.4	216.6–303.1	267.0–370.1	358.3–598.4	476.4–689.0	685.0–968.5	874.0–1374.0
250"	204.7	271.9–378.0	334.8–460.6	444.9–744.1	594.5–862.2	858.3–1212.6	1098.4–1720.5
300"	244.1	327.2–456.7	402.7–555.1	531.5–889.8	716.5–1035.4	1031.5–1456.7	1318.9–2070.9
350"	287.4	382.5–492.1	470.5–649.6	618.1–1039.4	838.6–1212.6	1208.7–1704.7	1543.3–2417.3
400"	326.8	437.9–610.2	538.4–744.1	704.7–1185.0	956.7–1385.8	1381.9–1948.8	1763.8–2763.8
500"	409.4	548.5–763.8	674.1–929.1	878.0–1476.4	1200.8–1736.2	1728.3–2440.9	2208.7–3460.6
600"	492.1	659.2–917.3	809.8–1118.1	1051.2–1771.7	1440.9–2086.6	2078.7–2929.1	2653.5–4153.5
800"	657.5	880.5–1224.4	1081.2–1492.1	1397.6–2358.3	1925.2–2783.5	2775.6–3913.4	3543.3–5547.2
1000"	822.8	1101.8–1531.5	1352.6–1866.1	1744.1–2944.9	2409.4–3484.3	3468.5–4893.7	4433.1–6937.0

unit: m

Screen size	Lens model name						
	L2K-10F1	L4K-11ZM	L4K-15ZM	L4K-20ZM	L2K-30ZM	L2K-43ZM1	L2K-55ZM1
100"	2.0	2.7–3.8	3.3–4.6	4.7–7.7	5.9–8.6	8.6–12.1	11.0–17.2
120"	2.4	3.3–4.6	4.0–5.6	5.5–9.2	7.1–10.4	10.3–14.6	13.2–20.8
150"	3.1	4.1–5.7	5.1–7.0	6.9–11.4	9.0–13.0	13.0–18.3	16.6–26.1
200"	4.1	5.5–7.7	6.8–9.4	9.1–15.2	12.1–17.5	17.4–24.6	22.2–34.9
250"	5.2	6.9–9.6	8.5–11.7	11.3–18.9	15.1–21.9	21.8–30.8	27.9–43.7
300"	6.2	8.3–11.6	10.2–14.1	13.5–22.6	18.2–26.3	26.2–37.0	33.5–52.6
350"	7.3	9.7–12.5	12.0–16.5	15.7–26.4	21.3–30.8	30.7–43.3	39.2–61.4
400"	8.3	11.1–15.5	13.7–18.9	17.9–30.1	24.3–35.2	35.1–49.5	44.8–70.2
500"	10.4	13.9–19.4	17.1–23.6	22.3–37.5	30.5–44.1	43.9–62.0	56.1–87.9
600"	12.5	16.7–23.3	20.6–28.4	26.7–45.0	36.6–53.0	52.8–74.4	67.4–105.5
800"	16.7	22.4–31.1	27.5–37.9	35.5–59.9	48.9–70.7	70.5–99.4	90.0–140.9
1000"	20.9	28.0–38.9	34.4–47.4	44.3–74.8	61.2–88.5	88.1–124.3	112.6–176.2

TIP

- Calculation of the throw distance from the screen size

L2K-10F1 lens throw distance (m) = $H \times 0.93$: 78.7"/2.0 m (min.) to 822.8"/20.9 m (max.)

L4K-11ZM lens throw distance (m) = $H \times 1.24$ to $H \times 1.73$: 105.9"/2.7 m (min.) to 1531.5"/38.9 m (max.)

L4K-15ZM lens throw distance (m) = $H \times 1.52$ to $H \times 2.10$: 131.2"/3.3 m (min.) to 1866.1"/47.4 m (max.)

L4K-20ZM lens throw distance (m) = $H \times 1.98$ to $H \times 3.34$: 185.0"/4.7 m (min.) to 2944.9"/74.8 m (max.)

L2K-30ZM lens throw distance (m) = $H \times 2.71$ to $H \times 3.92$: 232.3"/5.9 m (min.) to 3484.3"/88.5 m (max.)

L2K-43ZM1 lens throw distance (m) = $H \times 3.91$ to $H \times 5.52$: 338.6"/8.6 m (min.) to 4893.7"/124.3 m (max.)

L2K-55ZM1 lens throw distance (m) = $H \times 4.99$ to $H \times 7.82$: 433.1"/11.0 m (min.) to 6937.0"/176.2 m (max.)

"H" (Horizontal) refers to the screen width.

* Figures differ by several % with the table above because the calculation is approximate.

Ex.: Throw distance when projecting on a 300" screen using the L4K-15ZM lens:

According to the "Tables of screen sizes and dimensions" in case of 4096 × 2160 (Aspect Ratio 17:9) (→ page 146), H (screen width) = 265.4"/6.74 m.

The throw distance is 265.4"/6.74 m × 1.52 to 265.4"/6.74 m × 2.10 = 403.41"/10.24 m to 557.34"/14.15 m (because of the zoom lens).

3840 × 2160 (Aspect ratio: 16:9)

unit: inch

Screen size	Lens model name						
	L2K-10F1	L4K-11ZM	L4K-15ZM	L4K-20ZM	L2K-30ZM	L2K-43ZM1	L2K-55ZM1
100"	82.7	111.5–157.5	138.2–192.9	192.9–318.9	244.1–354.3	354.3–500.0	452.8–712.6
120"	102.4	134.9–189.0	166.6–232.3	228.3–381.9	295.3–429.1	429.1–602.4	547.2–858.3
150"	126.0	169.8–240.2	209.2–291.3	283.5–472.4	370.1–539.4	535.4–759.8	689.0–1078.7
200"	169.3	228.0–318.9	280.3–389.8	374.0–629.9	500.0–720.5	720.5–1015.7	921.3–1444.9
250"	212.6	286.3–401.6	351.3–488.2	464.6–783.5	626.0–905.5	901.6–1275.6	1153.5–1811.0
300"	255.9	344.6–480.3	422.3–586.6	555.1–937.0	752.0–1090.6	1086.6–1531.5	1385.8–2173.2
350"	299.2	402.8–559.1	493.3–685.0	645.7–1090.6	881.9–1271.7	1267.7–1791.3	1622.0–2539.4
400"	342.5	461.1–641.7	564.4–783.5	736.2–1248.0	1007.9–1456.7	1452.8–2047.2	1854.3–2905.5
500"	433.1	577.5–803.1	706.4–976.4	921.3–1555.1	1259.8–1822.8	1818.9–2563.0	2322.8–3637.8
600"	519.7	694.1–964.6	848.4–1173.2	1102.4–1862.2	1515.7–2192.9	2185.0–3078.7	2787.4–4366.1
800"	692.9	927.1–1287.4	1132.5–1566.9	1464.6–2480.3	2023.6–2925.2	2917.3–4110.2	3724.4–5830.7
1000"	866.1	1160.0–1610.2	1416.6–1960.6	1830.7–3098.4	2531.5–3661.4	3645.7–5141.7	4657.5–7291.3

unit: m

Screen size	Lens model name						
	L2K-10F1	L4K-11ZM	L4K-15ZM	L4K-20ZM	L2K-30ZM	L2K-43ZM1	L2K-55ZM1
100"	2.1	2.8–4.0	3.5–4.9	4.9–8.1	6.2–9.0	9.0–12.7	11.5–18.1
120"	2.6	3.4–4.8	4.2–5.9	5.8–9.7	7.5–10.9	10.9–15.3	13.9–21.8
150"	3.2	4.3–6.1	5.3–7.4	7.2–12.0	9.4–13.7	13.6–19.3	17.5–27.4
200"	4.3	5.8–8.1	7.1–9.9	9.5–16.0	12.7–18.3	18.3–25.8	23.4–36.7
250"	5.4	7.3–10.2	8.9–12.4	11.8–19.9	15.9–23.0	22.9–32.4	29.3–46.0
300"	6.5	8.8–12.2	10.7–14.9	14.1–23.8	19.1–27.7	27.6–38.9	35.2–55.2
350"	7.6	10.2–14.2	12.5–17.4	16.4–27.7	22.4–32.3	32.2–45.5	41.2–64.5
400"	8.7	11.7–16.3	14.3–19.9	18.7–31.7	25.6–37.0	36.9–52.0	47.1–73.8
500"	11.0	14.7–20.4	17.9–24.8	23.4–39.5	32.0–46.3	46.2–65.1	59.0–92.4
600"	13.2	17.6–24.5	21.6–29.8	28.0–47.3	38.5–55.7	55.5–78.2	70.8–110.9
800"	17.6	23.5–32.7	28.8–39.8	37.2–63.0	51.4–74.3	74.1–104.4	94.6–148.1
1000"	22.0	29.5–40.9	36.0–49.8	46.5–78.7	64.3–93.0	92.6–130.6	118.3–185.2

TIP

- Calculation of the throw distance from the screen size

L2K-10F1 lens throw distance (m) = $H \times 0.99$: 82.7"/2.1 m (min.) to 866.1"/22.0 m (max.)

L4K-11ZM lens throw distance (m) = $H \times 1.33$ to $H \times 1.84$: 111.5"/2.8 m (min.) to 1610.2"/40.9 m (max.)

L4K-15ZM lens throw distance (m) = $H \times 1.62$ to $H \times 2.24$: 138.2"/3.5 m (min.) to 1960.6"/49.8 m (max.)

L4K-20ZM lens throw distance (m) = $H \times 2.11$ to $H \times 3.57$: 192.9"/4.9 m (min.) to 3098.4"/78.7 m (max.)

L2K-30ZM lens throw distance (m) = $H \times 2.89$ to $H \times 4.19$: 244.1"/6.2 m (min.) to 3661.4"/93.0 m (max.)

L2K-43ZM1 lens throw distance (m) = $H \times 4.17$ to $H \times 5.88$: 354.3"/9.0 m (min.) to 5141.7"/130.6 m (max.)

L2K-55ZM1 lens throw distance (m) = $H \times 5.33$ to $H \times 8.34$: 452.8"/11.5 m (min.) to 7291.3"/185.2 m (max.)

"H" (Horizontal) refers to the screen width.

* Figures differ by several % with the table above because the calculation is approximate.

Ex.: Throw distance when projecting on a 300" screen using the L4K-15ZM lens:

According to the "Tables of screen sizes and dimensions" in case of 3840 × 2160 (Aspect Ratio 16:9) (→ page 146), H (screen width) = 261.5"/6.64 m.

The throw distance is $261.5"/6.64 \text{ m} \times 1.62$ to $261.5"/6.64 \text{ m} \times 2.24 = 423.63"/10.76 \text{ m}$ to $585.76"/14.87 \text{ m}$ (because of the zoom lens).

Projection range for the different lenses
4096 × 2160 (Aspect ratio: 17:9)

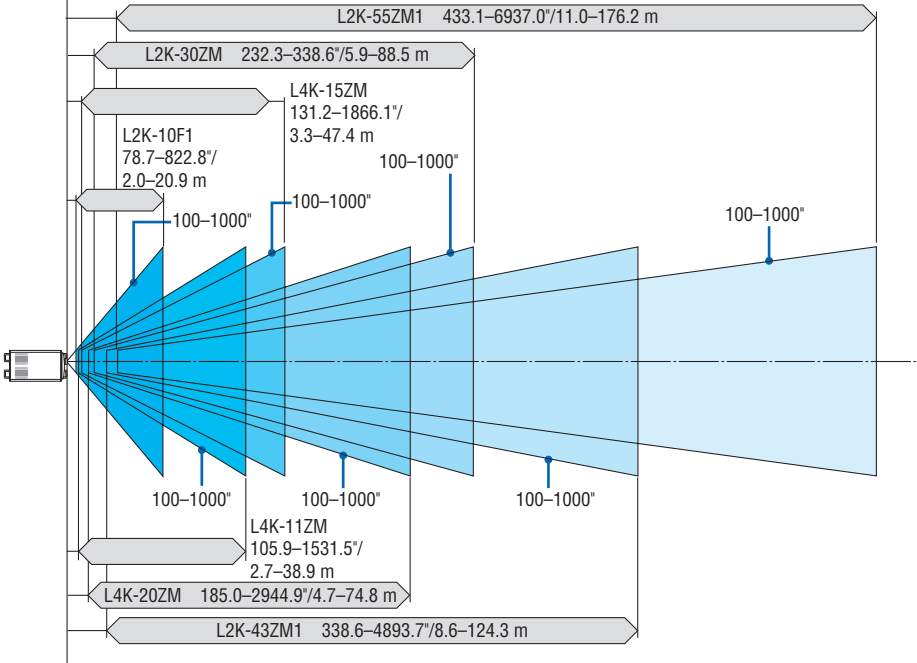

3840 × 2160 (Aspect ratio: 16:9)

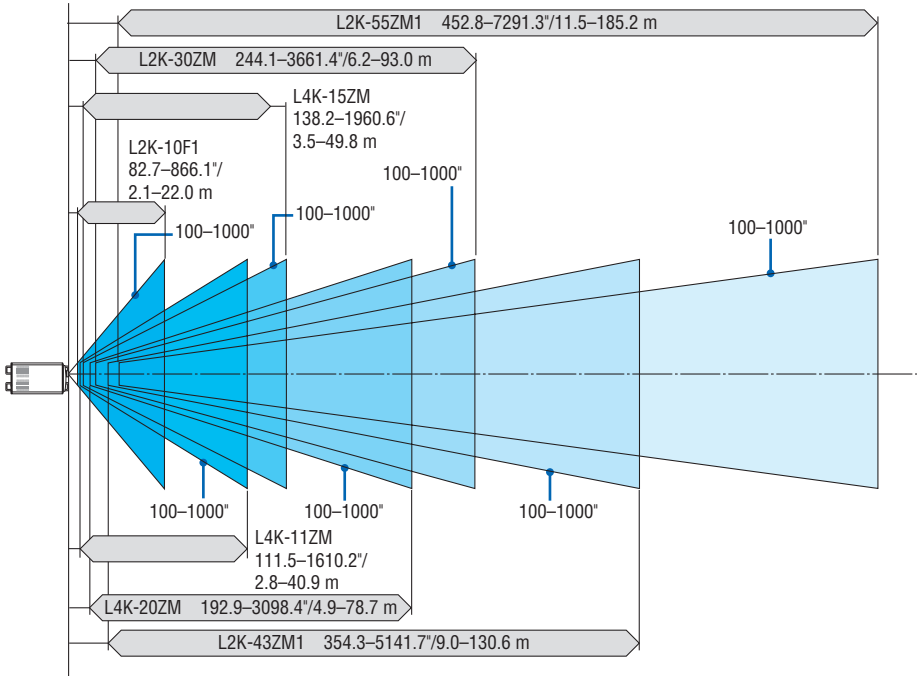

Tables of screen sizes and dimensions

4096 × 2160 (Aspect ratio: 17:9)

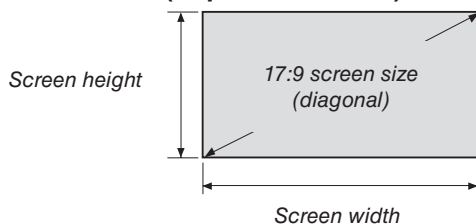

Size (inches)	Screen width		Screen height	
	(inches)	(cm)	(inches)	(cm)
100	88.5	224.7	46.6	118.5
120	106.1	269.6	56.0	142.2
150	132.7	337.0	70.0	177.7
200	176.9	449.3	93.3	237.0
250	221.1	561.7	116.6	296.2
300	265.4	674.0	139.9	355.4
350	309.6	786.4	163.3	414.7
400	353.8	898.7	186.6	473.9
450	398.0	1011.0	209.9	533.2
500	442.3	1123.4	233.2	592.4
550	486.5	1235.7	256.6	651.6
600	530.7	1348.0	279.9	710.9
650	575.0	1460.4	303.2	770.1
700	619.2	1572.7	326.5	829.4
750	663.4	1685.1	349.8	888.6
800	707.6	1797.4	373.2	947.8
850	751.9	1909.7	396.5	1007.1
900	796.1	2022.1	419.8	1066.3
950	840.3	2134.4	443.1	1125.6
1000	884.5	2246.7	466.5	1184.8

3840 × 2160 (Aspect ratio: 16:9)

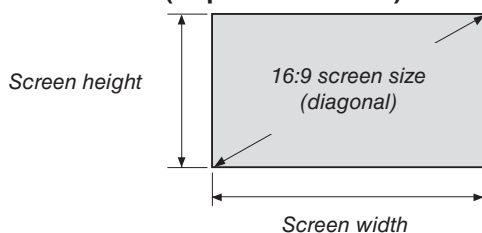

Size (inches)	Screen width		Screen height	
	(inches)	(cm)	(inches)	(cm)
100	87.2	221.4	49.0	124.5
120	104.6	265.7	58.8	149.4
150	130.7	332.1	73.5	186.8
200	174.3	442.8	98.1	249.1
250	217.9	553.5	122.6	311.3
300	261.5	664.1	147.1	373.6
350	305.1	774.8	171.6	435.8
400	348.6	885.5	196.1	498.1
450	392.2	996.2	220.6	560.4
500	435.8	1106.9	245.1	622.6
550	479.4	1217.6	269.6	684.9
600	522.9	1328.3	294.2	747.2
650	566.5	1439.0	318.7	809.4
700	610.1	1549.7	343.2	871.7
750	653.7	1660.4	367.7	933.9
800	697.3	1771.0	392.2	996.2
850	740.8	1881.7	416.7	1058.5
900	784.4	1992.4	441.2	1120.7
950	828.0	2103.1	465.7	1183.0
1000	871.6	2213.8	490.3	1245.3

Lens shifting range

This projector is equipped with a lens shift function for adjusting the position of the projected image by using the LENS SHIFT buttons (→ page 30). The lens can be shifted within the range shown below.

NOTE:

- Please do not use the lens shift function when projecting portrait images. Please use it with the lens in the center.

Legend: V “Vertical” refers to the screen height and H “Horizontal” refers to the screen width. The lens shift range is expressed as a ratio of height and width, respectively.

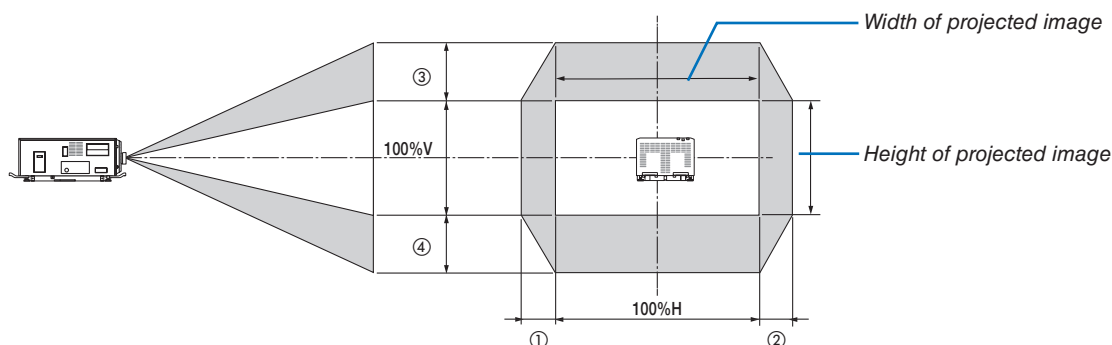

* The lens shift range is the same for ceiling installation.

4096 × 2160 (Aspect ratio: 17:9)

Lens unit	Drawing number	
	①②	③④
L2K-10F1	8%H	27%V
L4K-11ZM	17%H	50%V
L4K-15ZM	17%H	50%V
L4K-20ZM	17%H	50%V
L2K-30ZM	8%H	27%V
L2K-43ZM1	8%H	27%V
L2K-55ZM1	10%H	31%V

(Example calculation) If projecting on a 300 inch screen using an L4K-15ZM lens unit

According to the “Table of screen sizes and dimensions” (→ page 146), H = 265.4"/674.0 cm, V = 139.9"/355.4 cm. Adjustment range in the vertical direction: the projected image can be moved upwards $0.5 \times 139.9"/355.4 \text{ cm} \approx 70"/178 \text{ cm}$, downwards approximately 70"/178 cm (when the lens is at the center position). Adjustment range in the horizontal direction: the projected image can be moved to the left $0.17 \times 265.4"/674.0 \text{ cm} \approx 45"/115 \text{ cm}$, to the right approximately 45"/115 cm.

* Figures differ by several % because the calculation is approximate.

3840 × 2160 (Aspect ratio: 16:9)

Lens unit	Drawing number	
	①②	③④
L2K-10F1	12%H	34%V
L4K-11ZM	22%H	55%V
L4K-15ZM	22%H	55%V
L4K-20ZM	22%H	55%V
L2K-30ZM	12%H	34%V
L2K-43ZM1	12%H	34%V
L2K-55ZM1	14%H	37%V

(Example calculation) If projecting on a 300 inch screen using an L4K-15ZM lens unit

According to the "Table of screen sizes and dimensions" (→ page 146), $H = 261.5"/664.1 \text{ cm}$, $V = 147.1"/373.6 \text{ cm}$.
 Adjustment range in the vertical direction: the projected image can be moved upwards $0.55 \times 147.1"/373.6 \text{ cm} \approx 81"/205 \text{ cm}$, downwards approximately $81"/205 \text{ cm}$ (when the lens is at the center position). Adjustment range in the horizontal direction: the projected image can be moved to the left $0.22 \times 261.5"/664.1 \text{ cm} \approx 58"/146 \text{ cm}$, to the right approximately $58"/146 \text{ cm}$.

* Figures differ by several % because the calculation is approximate.

② Compatible Input Signal List

HDMI/HDBaseT

Signal	Resolution (dots)	Aspect Ratio	Refresh Rate (Hz)
VGA	640 × 480	4 : 3	60/72/75/85/iMac
SVGA	800 × 600	4 : 3	56/60/72/75/85/iMac
XGA	1024 × 768	4 : 3	60/70/75/85/iMac
HD	1280 × 720	16 : 9	60
WXGA	1280 × 768	15 : 9	60
	1280 × 800	16 : 10	60
Quad-VGA	1280 × 960	4 : 3	60
SXGA	1280 × 1024	5 : 4	60
FWXGA	1366 × 768	16 : 9	60
	1366 × 768	16 : 9	60
SXGA+	1400 × 1050	4 : 3	60
WXGA+	1440 × 900	16 : 10	60
WXGA++	1600 × 900	16 : 9	60
WSXGA+	1680 × 1050	16 : 10	60
UXGA	1600 × 1200	4 : 3	60
Full HD	1920 × 1080	16 : 9	60
WUXGA	1920 × 1200 *1	16 : 10	60 (Reduced Blanking)
2K	2048 × 1080 *1	17 : 9	60
WQHD iMac 27"	2560 × 1440 *1	16 : 9	60
WQXGA	2560 × 1600 *1	16 : 10	60 (Reduced Blanking)
	3840 × 2160	16 : 9	24/25/30/50*/1/60*1
4K	4096 × 2160 *2	17 : 9	24/25/30/50*/1/60*1
	1920 × 1080	16 : 9	24/25/30/50/60
HDTV (1080p)	1920 × 1080	16 : 9	24/25/30/50/60
HDTV (1080i)	1920 × 1080	16 : 9	48/50/60
HDTV (720p)	1280 × 720	16 : 9	50/60
SDTV (480p)	720/1440 × 480	4:3 / 16:9	60
SDTV (576p)	720/1440 × 576	4:3 / 16:9	50
SDTV (480i)	1440 × 480	4:3 / 16:9	60
SDTV (576i)	1440 × 576	4:3 / 16:9	50

DisplayPort

Signal	Resolution (dots)	Aspect Ratio	Refresh Rate (Hz)
VGA	640 × 480	4 : 3	60
SVGA	800 × 600	4 : 3	60
XGA	1024 × 768	4 : 3	60
HD	1280 × 720	16 : 9	60
WXGA	1280 × 768	15 : 9	60
	1280 × 800	16 : 10	60
Quad-VGA	1280 × 960	4 : 3	60
SXGA	1280 × 1024	5 : 4	60
FWXGA	1366 × 768	16 : 9	60
	1366 × 768	16 : 9	60
SXGA+	1400 × 1050	4 : 3	60
WXGA+	1440 × 900	16 : 10	60
WXGA++	1600 × 900	16 : 9	60
WSXGA+	1680 × 1050	16 : 10	60
UXGA	1600 × 1200	4 : 3	60
Full HD	1920 × 1080	16 : 9	60
WUXGA	1920 × 1200	16 : 10	60 (Reduced Blanking)
2K	2048 × 1080	17 : 9	60
WQHD iMac 27"	2560 × 1440	16 : 9	60
WQXGA	2560 × 1600	16 : 10	60 (Reduced Blanking)
	3840 × 2160	16 : 9	24/25/30/50/60
4K	4096 × 2160 *2	17 : 9	24/25/30/50/60
	1920 × 1080	16 : 9	24/25/30/50/60
HDTV (1080p)	1920 × 1080	16 : 9	24/25/30/50/60
HDTV (720p)	1280 × 720	16 : 9	50/60
SDTV (480i/p)	720/1440 × 480	4:3 / 16:9	60
SDTV (576i/p)	720/1440 × 576	4:3 / 16:9	50

SDI

Signal	Resolution (dots)	Aspect Ratio	Refresh Rate (Hz)
HD-SDI (1035i)	1920 × 1035	16 : 9	60
HD-SDI (1080i)	1920 × 1080	16 : 9	50/60
HD-SDI (1080p)	1920 × 1080	16 : 9	24pSF
HD-SDI (1080p)	1920 × 1080	16 : 9	24/25/30
HD-SDI (720p)	1280 × 720	16 : 9	24/25/30/50/60
3G-SDI (1080p)	1920 × 1080	16 : 9	50/60
3G-SDI (1080p)	1920 × 1080	16 : 9	24/25/30
3G-SDI (1080p)	1920 × 1080	16 : 9	24pSF
3G-SDI (1080i)	1920 × 1080	16 : 9	50/60
Quad SDI	3840 × 2160	16 : 9	24/25/30/50/60
Quad SDI	4096 × 2160 *2	17 : 9	24/25/30/50/60

HDBaseT / DisplayPort 3D

Signal Resolution (dots)	Aspect Ratio	Refresh Rate (Hz)	3D Format
1920 × 1080p	16 : 9	23.98/24	Frame Packing
			Side By Side (Half)
			Top and Bottom
		25	Frame Packing
			Side By Side (Half)
			Top and Bottom
29.97/30	Frame Packing		
	Side By Side (Half)		
	Top and Bottom		
1280 × 720p	16 : 9	23.98/24	Frame Packing
			Side By Side (Half)
			Top and Bottom
		25	Frame Packing
			Side By Side (Half)
			Top and Bottom
29.97/30	Frame Packing		
	Side By Side (Half)		
	Top and Bottom		

*1 HDBaseT does not support this signal.

*2 Native resolution

- Upon shipment, the projector is set for signals with standard display resolutions and frequencies, but adjustments may be required depending on the type of computer.

3 Specifications

Model name	PH3501QL		PH2601QL
Projection method	3 chip DLP® method		
DMD panel	Size	1.38", aspect ratio 17:9	
	Pixels ^(*)	8,847,360 (4096 dots × 2160 lines)	
Light source	Laser Diode		
Light output ^(*)	35,000 lm ^(*) / 40,000 lm (center)		26,000 lm ^(*) / 30,000 lm (center)
Contrast ratio ^(*) (all white/all black)	30,000:1 with dynamic contrast		
Lens adjustment function	Motorized lens shift (vertical/horizontal), motorized zoom, motorized focus		
External Control	RS-232C (D-sub 9pin) × 1 GP I/O port (D-sub 37 pin) × 1 3D CTL (D-sub 15 pin) × 1 Service USB (Type A) × 1	Remote terminal (Stereo mini jack) × 1 Ethernet port (RJ-45) × 1 Remote interlock port × 1	
Power supply voltage	For C1 connection ^(*) : Single phase AC 200V-240V 50/60Hz (projector power supply + light power supply) For C2 connection ^(*) : Single phase AC 200V-240V 50/60Hz (projector power supply) Single phase AC 200V-240V 50/60Hz (light power supply)		
Power consumption ^(*)	4,705 W		3,665 W
Input current ^(*)	For C1 connection ^(*) projector power supply + light power supply: 30.0A For C2 connection ^(*) projector power supply: 4.9A light power supply: 25.1A		
Cooling method	Cooling fluid system, Cooling air system		
Noise level	Less than 55 dB		
Installation	Orientation: Desktop/front, Desktop/rear, Ceiling/front, Ceiling/rear		
Net weight	169 kg (Does not include lens and LV unit)		
Dimensions	697 mm (W) × 1180 mm (D) × 455 mm (H) / 27.4 inch (W) × 46.5 inch (D) × 17.9 inch (H) (Does not including protruding portions, includes foot.)		
Environment ^(*)	Operating temperature: 5 to 40°C		
	Operating humidity: 20 to 80% (non-condensing)		
	Storage temperature: -10 to 50°C		
	Storage humidity: 20 to 80% (non-condensing)		
Operating altitude: 0 to 2600 m/8500 feet			

Model name	NP-LV01BD		
Color reproducibility	10-bit color processing (approx. 1.07 billion colors)		
Scanning frequency	Horizontal	15 kHz, 24 to 153 kHz, conforming to VESA standards	
	Vertical	24, 25, 30, 48 Hz, 50 to 85 Hz, 100, 120 Hz conforming to VESA standards	
Max. display resolution (horizontal × vertical)	Digital 4096 × 2160		
Input connectors			
HDMI	Video input	HDMI® Connector type A × 2 Deep Color (color depth): 8-/10-/12-bit compatible Colorimetry: RGB, YCbCr444, YCbCr422 Supports HDCP ^(*) and 4K	
DisplayPort	Video input	DisplayPort × 2 Data rate: 5.4 Gbps/2.7 Gbps/1.62 Gbps No. lanes: 1 lane/2 lanes/4 lanes Color depth: 8 bits, 10 bits Colorimetry: RGB, YCbCr444, YCbCr422 Supports HDCP ^(*) and 4K	
Ethernet/HDBaseT	Video input	RJ-45 × 1, 100BASE-TX Deep Color (color depth): 8-/10-/12-bit compatible Colorimetry: RGB, YCbCr444, YCbCr422 Supports HDCP ^(*) and 4K	
3G/HD/SD-SDI	Video input	BNC × 4 Input signals: SMPTE292M, SMPTE424M Colorimetry: RGB, YCbCr444, YCbCr422	
SLOT	For mounting separately sold options		
Net weight	1.1 kg		
Dimensions	320 mm (W) × 220 mm (D) × 81.5 mm (H) / 12.6 inch (W) × 8.7 inch (D) × 3.2 inch (H)		

- *1 Effective pixels are more than 99.99%.
- *2 This is the light output value that results from setting [PRESET] to [HIGH-BRIGHT] and setting [LIGHT ADJUST] to [100%]. If any other mode is selected for [PRESET], the brightness becomes lower.
- *3 This indicates the average value in the total shipment of the product. Compliance with ISO21118-2012.
- *4 Numerical value with the LV unit NP-LV01BD installed.
- *5 C1 connection is the case when the AC power to the projector power supply and the light power supply is provided by a single cable.
C2 connection is the case when the AC power to the projector power supply and the light power supply is provided by separate cables.
- *6 If you are unable to view material via the HDMI input, DisplayPort input and HDBaseT input, this does not necessarily mean the projector is not functioning properly. With the implementation of HDCP technology, there may be cases in which certain content is protected with HDCP and might not be displayed due to the decision/intention of the HDCP community (Digital Content Protection, LLC).
Video: Deep Color, 8/10/12-bit
HDMI: Supports HDCP 1.4/2.2
DisplayPort: Supports HDCP 1.4
HDBaseT: Supports HDCP 1.4/2.2
- * Described the certification standard for laser products in "Important Information" of this manual.
- * Note that these specifications and design can change without prior notice.

For additional information visit:

US: <https://www.necdisplay.com/>

Europe: <https://www.nec-display-solutions.com/>

Global: <https://www.nec-display.com/global/index.html>

For information on our optional accessories, visit our website or see our brochure.

Option lens (sold separately)

L2K-10F1	Power lens shift, Power focus (Throw ratio 0.93:1, F2.5, f = 28.95 mm)
L4K-11ZM	Power lens shift, Power zoom, Power focus, [LENS MEMORY] support (Throw ratio 1.24–1.73:1, F2.5/2.5, f = 35.2–53.7 mm)
L4K-15ZM	Power lens shift, Power zoom, Power focus, [LENS MEMORY] support (Throw ratio 1.52–2.10:1, F2.5/2.5, f = 45.3–65.6 mm)
L4K-20ZM	Power lens shift, Power zoom, Power focus, [LENS MEMORY] support (Throw ratio 1.98–3.34:1, F2.5/2.5, f = 61.4–105.2 mm)
L2K-30ZM	Power lens shift, Power zoom, Power focus, [LENS MEMORY] support (Throw ratio 2.71–3.92:1, F2.5/2.5, f = 85.0–121.63 mm)
L2K-43ZM1	Power lens shift, Power zoom, Power focus, [LENS MEMORY] support (Throw ratio 3.91–5.52:1, F2.5/2.5, f = 122.76–172.33 mm)
L2K-55ZM1	Power lens shift, Power zoom, Power focus, [LENS MEMORY] support (Throw ratio 5.00–7.80:1, F2.5/2.5, f = 156.54–243.12 mm)

4 Outline Drawing

Unit: mm (inch)

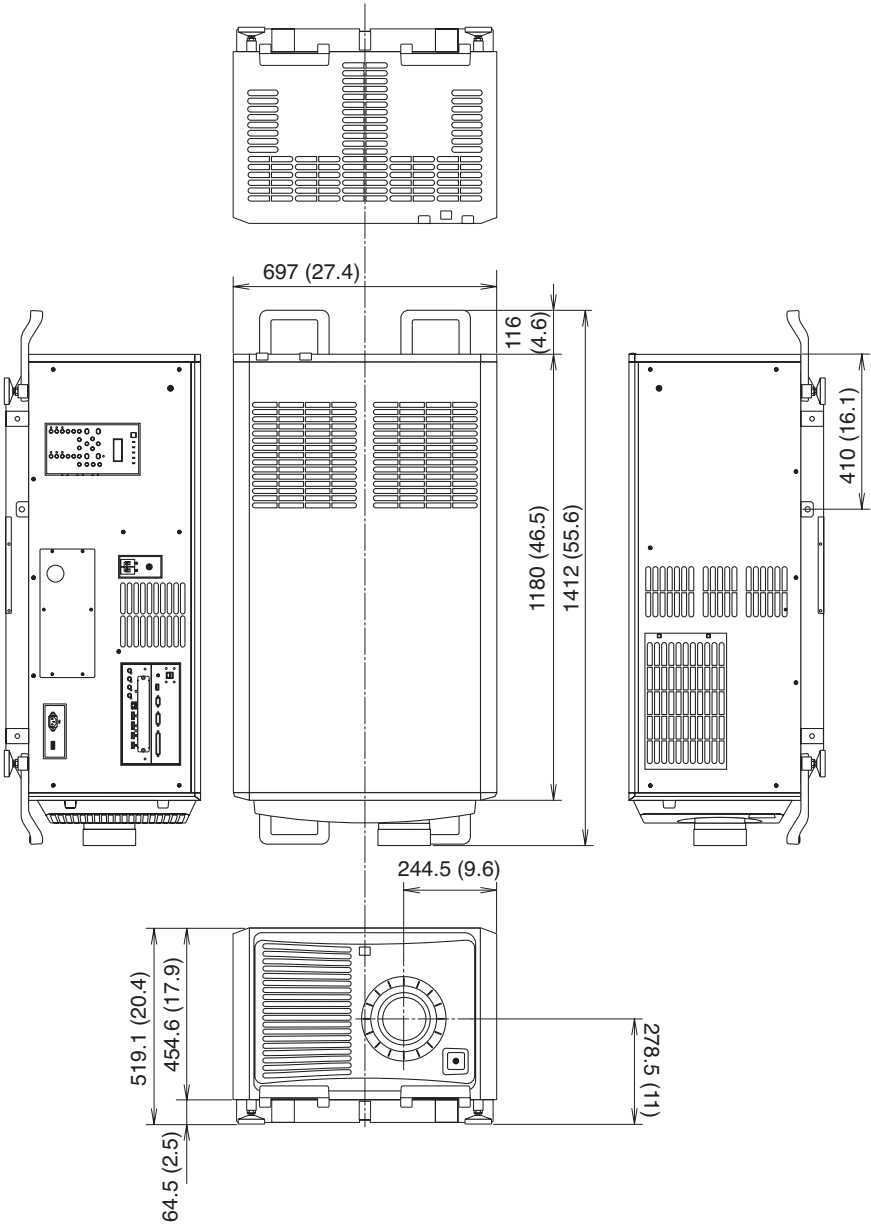

5 Portrait projection (vertical orientation)

If you install the projector vertically you can project screens from your computer and other sources in portrait orientation.

- Be sure to install the device with the side where the Connection terminals and Controls/Indicator Panel are located facing the top.
- Angle to display all the screens such as the on-screen menu can be changed by the menu [SETUP] → [MENU (2)] → [MENU ANGLE].

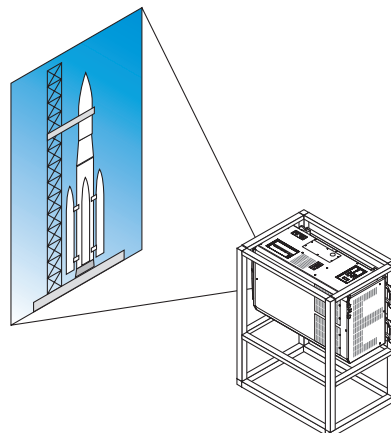

⚠ Precautions during installation

- Do not simply set the projector vertically on the floor or on a table. The projector may fall over, resulting in injury, damage or malfunction. Also the intake vent may become blocked causing the unit's internal temperature to rise resulting in malfunction and risk of fire.
- For portrait installation the intake vents must be installed at the top and bottom. To ensure air flow to the bottom intake vent, a rack to support the unit is necessary. Please hire an installation service provider (for a fee) to make a custom portrait projection stand.
- When installed in portrait orientation the projector can be tilted forward or backward within a range of $\pm 10^\circ$. Tilting the projector forward or backward outside of this range, or tilting it to the left or to the right could cause it to malfunction.

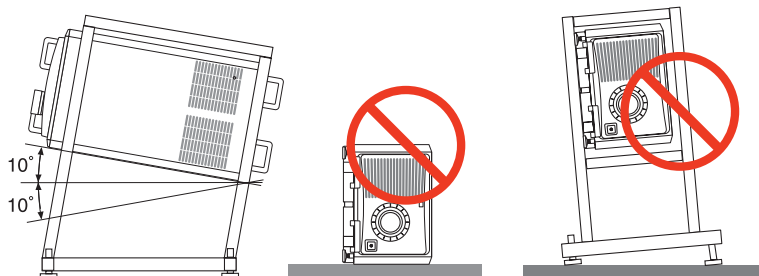

- To ensure air flow, maintain 60 cm/23.6" of space between the intake vent and the installation surface.

(NOTE) In the figure to the right there is plenty of space behind, above, and on either side of the projector unit.

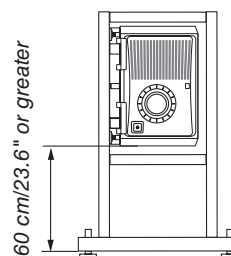

6 Pin assignments and signal names of main terminals

HDMI1/2 IN Terminal (Type A)

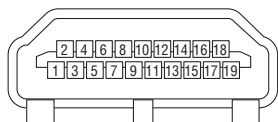

Pin No.	Signal	Pin No.	Signal
1	TMDS Data 2+	11	TMDS Clock Shield
2	TMDS Data 2 Shield	12	TMDS Clock-
3	TMDS Data 2-	13	CEC
4	TMDS Data 1+	14	Disconnection
5	TMDS Data 1 Shield	15	SCL
6	TMDS Data 1-	16	SDA
7	TMDS Data 0+	17	DDC/CEC grounding
8	TMDS Data 0 Shield	18	+5 V power supply
9	TMDS Data 0-	19	Hot plug detection
10	TMDS Clock +		

DisplayPort1/2 IN Terminal

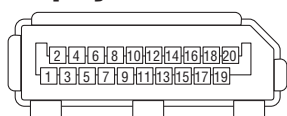

Pin No.	Signal	Pin No.	Signal
1	Main link lane 3-	11	Grounding 0
2	Grounding 3	12	Main link lane 0+
3	Main link lane 3+	13	Configuration 1
4	Main link lane 2-	14	Configuration 2
5	Grounding 2	15	Supplementary channel +
6	Main link lane 2+	16	Grounding 4
7	Main link lane 1-	17	Supplementary channel -
8	Grounding 1	18	Hot plug detection
9	Main link lane 1+	19	Return
10	Main link lane 0-	20	+3.3 V power supply

HDBaseT Port (RJ-45)

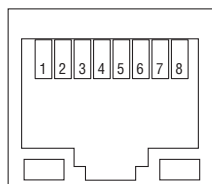

Pin No.	Signal
1	TxD+/HDBT0+
2	TxD-/HDBT0-
3	RxD+/HDBT1+
4	Disconnection/HDBT2+
5	Disconnection/HDBT2-
6	RxD-/HDBT1-
7	Disconnection/HDBT3+
8	Disconnection/HDBT3-

USB Port (Type A)

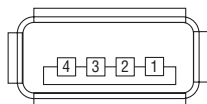

Pin No.	Signal
1	V _{BUS}
2	D-
3	D+
4	Grounding

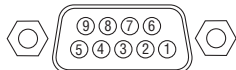
RS-232C terminal (PC control) (D-Sub 9 Pin)

Pin No.	Signal
1	Unused
2	Transmission data
3	Reception data
4	Connection/Pin 6
5	Grounding
6	Connection/Pin 4
7	Unused
8	Unused
9	Unused

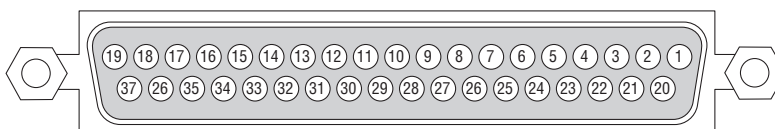
GP I/O terminal (External control) (D-sub 37 pin)

Pin No.	Signal Name	I/O
1	reserved	IN
2	reserved	IN
3	reserved	IN
4	reserved	IN
5	EXT_GPIN1+ (Control)	IN
6	EXT_GPIN2+ (Control)	IN
7	EXT_GPIN3+ (Control)	IN
8	EXT_GPIN4+ (Control)	IN
9	GPOUT1+ (External 3D L/R Output Reference +)	OUT
10	reserved	OUT
11	reserved	OUT
12	reserved	OUT
13	reserved	OUT
14	reserved	OUT
15	reserved	OUT
16	reserved	OUT
17	NC (not connected)	—
18	GND	PWR
19	GND	PWR

Pin No.	Signal Name	I/O
20	reserved	IN
21	reserved	IN
22	reserved	IN
23	reserved	IN
24	EXT_GPIN1- (Control)	IN
25	EXT_GPIN2- (Control)	IN
26	EXT_GPIN3- (Control)	IN
27	EXT_GPIN4- (Control)	IN
28	GPOUT1- (External 3D L/R Output Reference -)	OUT
29	reserved	OUT
30	reserved	OUT
31	reserved	OUT
32	reserved	OUT
33	reserved	OUT
34	reserved	OUT
35	reserved	OUT
36	NC (not connected)	—
37	GND	PWR

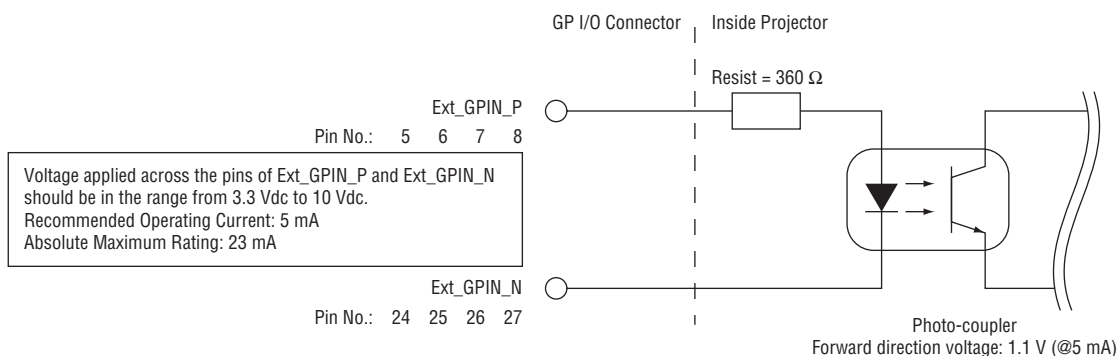

Using GP I/O Control

Momentary “ON” pulse enables you to control projector. To enable “ON” pulse, hold it for at least 300 ms. Hold “OFF” for at least 300 ms before “ON”. (→ page 158)

Here is function list to control projector by using GP I/O port.

Photo-coupler ON/OFF				Function
8-27	7-26	6-25	5-24	The following functions apply depending on the combination of input terminals.
OFF	OFF	OFF	ON	Power ON
OFF	OFF	ON	OFF	Power OFF
OFF	OFF	ON	ON	Shutter CLOSE
OFF	ON	OFF	OFF	Shutter OPEN
OFF	ON	OFF	ON	Select HDMI1
OFF	ON	ON	OFF	Select DisplayPort1
OFF	ON	ON	ON	Select SDI1
ON	OFF	OFF	OFF	Select SDI2
ON	OFF	OFF	ON	Select SDI3
ON	OFF	ON	OFF	Select SDI4
ON	OFF	ON	ON	Select HDBaseT
ON	ON	OFF	OFF	Select SLOT
ON	ON	OFF	ON	Select HDMI2
ON	ON	ON	OFF	Select DisplayPort2
ON	ON	ON	ON	reserved

Example for setting the shutter to CLOSE: Input ON to 6-25 and 5-24 while 8-27 and 7-26 are OFF.

NOTE:

- The operation command coming from GP I/O port will be canceled when the projector is processing other tasks.
- Set all other pins than those in use to “OFF”.
- The operation command is executed upon continuous input of the “ON” pulse for approximately 300 ms.

Timing chart of GP I/O control
Example of Select HDMI1

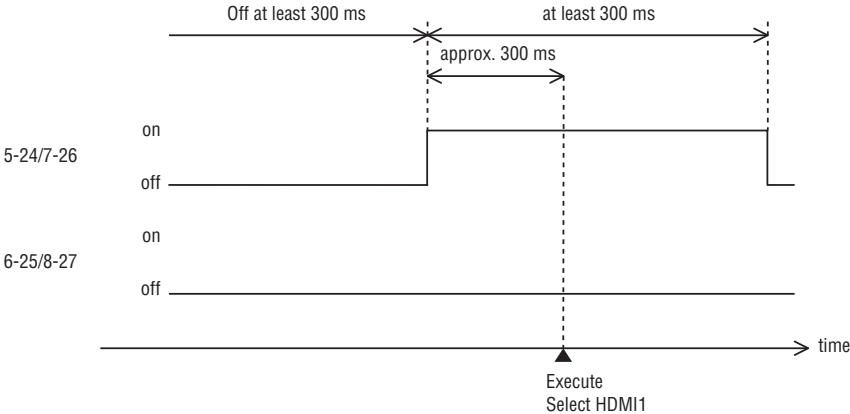

3D terminal (D-sub 15 pin)

This is used to connect a 3D image system to the projector.

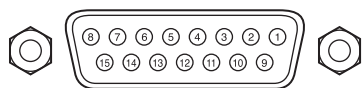

Pin view of a female connector

Pin No.	Signal Name	I/O	Function
1	+12V	PWR	Supplies power (+12V) to the 3D image system
2	GNDC	GND	Ground
3	GNDC	GND	Ground
4	RS232_RX	IN	Data transmission from the 3D image system (1200 Baud, 8 bits, No Parity)
5	RS232_TX	OUT	Data transmission to the 3D image system (1200 Baud, 8 bits, No Parity)
6	CONN_3D_MODE+	OUT	3D mode status (+) (Connects to the collector of the output transistor of the photo coupler inside the projector)
7	CONN_SYNC+	OUT	3D L/R switching timing signal (+) (Connects to the collector of the output transistor of the photo coupler inside the projector)
8	3D_INPUT_REFER- ENCE+	IN	3D L/R timing signal (+) (Connects to the anode of the input diode of the photo coupler inside the projector)
9	+12V	PWR	Supplies power (+12V) to the 3D image system
10	3D_INPUT_REFER- ENCE-	IN	3D L/R timing signal (-) (Connects to the cathode of the input diode of the photo coupler inside the projector)
11	3D_DISPLAY_REFER- ENCE+	IN	3D L/R display timing signal (+) (Connects to the anode of the input diode of the photo coupler inside the projector)
12	3D_DISPLAY_REFER- ENCE-	IN	3D L/R display timing signal (-) (Connects to the cathode of the input diode of the photo coupler inside the projector)
13	CONN_3D_MODE-	OUT	3D mode status (-) (Connects to the emitter of the output transistor of the photo coupler inside the projector)
14	CONN_SYNC-	OUT	3D L/R switching timing signal (-) (Connects to the emitter of the output transistor of the photo coupler inside the projector)
15	N/C	-	Unused

7 About the ASCII Control Command

This device supports the common ASCII Control Command for controlling our projector and monitor. Please visit our web site for detailed information about the command.

https://www.nec-display.com/dl/en/pj_manual/lineup.html

HOW TO CONNECT WITH AN EXTERNAL DEVICE

There are two methods to connect the projector with an external device such as a computer.

1. Connection thru the serial port.
Connects the projector to a computer by a serial cable (straight cable).
2. Connection via network (LAN/HDBaseT)
Connects the projector to a computer by a LAN cable.
Concerning to the type of LAN cable, please ask to your network administrator.

CONNECTION INTERFACE

1. Connection thru the serial port.

Communication Protocol

Item	Information
Baud rate	115200/38400/19200/9600/4800 bps
Data length	8 bits
Parity bit	No parity
Stop bit	1 bit
Flow control	None
Communications procedure	Full duplex

2. Connection via network

Communication Protocol (Connection via LAN)

Item	Information
Communication speed	Set automatically (10/100 Mbps)
Supported standard	IEEE802.3 (10BASE-T) IEEE802.3u (100BASE-TX, Auto-Negotiation)

Use the TCP port number 7142 for transmitting and receiving command.

Communication Protocol (Connection via HDBaseT)

Item	Information
Communication speed	100 Mbps
Supported standard	IEEE802.3u (100BASE-TX, Auto-Negotiation)

Use the TCP port number 7142 for transmitting and receiving command.

PARAMETERS FOR THIS DEVICE**Input command**

Input terminal	Response	Parameter
HDMI1	hdmi1	hdmi1 or hdmi
HDMI2	hdmi2	hdmi2
DisplayPort1	displayport1	displayport1 or displayport
DisplayPort2	displayport2	displayport2
HDBaseT	hdbaset	hdbaset or hdbaset1
SDI1	sdi1	sdi1 or sdi
SDI2	sdi2	sdi2
SDI3	sdi3	sdi3
SDI4	sdi4	sdi4
SLOT	slot	slot or slot1

Status command

Response	Error Status
error:temp	Temperature error
error:fan	Fan trouble
error:light	Light source trouble
error:lens	Lens trouble
error:system	System trouble

8 Changing the Background Logo (Virtual Remote Tool)

This will help you perform operations such as projector's power on or off and signal selection via a LAN connection. It is also used to send an image to the projector and register it as the logo data of the projector. After registering it, you can lock the logo to prevent it from changing.

Control Functions

Power On/Off, signal selection, picture freeze, picture mute, Logo transfer to the projector, and remote control operation on your PC.

Virtual Remote screen



Remote Control Window

Use this button for changing the background logo.



Toolbar

For getting the Virtual Remote Tool, please visit our web site and download it:

<https://www.nec-display.com/dl/en/index.html>

NOTE:

- Remote Control Window is not available for changing the background logo.
Please see the HELP menu of the Virtual Remote Tool about how to display the Toolbar.
- Logo data (graphics) that can be sent to the projector with Virtual Remote Tool has the following restrictions:
(Only via serial or LAN connection)
 - * File size: Within 512 kilobytes
 - * Image size: Within the resolution of the projector
 - * File format: PNG (Full color)
- Logo data (image) sent using the Virtual Remote Tool will be displayed in the center with the surrounding area in black.
- To put the default "NEC logo" back in the background logo, you need to register it as the background logo by using the image file (Logo\NEC_logo2018_4096x2160.png) included on the supplied NEC Projector CD-ROM.

9 Troubleshooting

Before asking for repair, please check your connection, settings and operation once again. If the trouble cannot be corrected, please contact your dealer/distributor for instructions or repair.

Problems and where to check

Problem	Check These Items
The projector cannot be turned on.	<ul style="list-style-type: none"> • Check to see if AC power is supplied to the projector. • Make certain that the projector power switch and light power switch is ON. • Check to see whether the panel key lock function is activated. If so, the main unit's control buttons are locked and do not work. • Is the temperature inside the projector too high? When the inside temperature is too high, the protective function does not allow your projector to be turned on. Wait some time and then turn it on. • Is the administrator key inserted? The projector will not function unless the administrator key is inserted.
Will turn off	<ul style="list-style-type: none"> • Ensure that the [OFF TIMER], [AUTO POWER OFF] or [PROGRAM TIMER] is off. (→ page 116, 130)
The image cannot be projected.	<ul style="list-style-type: none"> • Check to see if the connected input has been selected. • Check to see if a cable is properly connected to the input terminal. • Is the [POWER ON SHUTTER] in the on-screen menu set to [CLOSE]? • Check that the SHUTTER (lens shutter), the LIGHT SOURCE, or AV MUTE (image off) buttons are not pressed. • Check to see if the settings are all adjusted properly. • If the HDMI1/2 IN or the DisplayPort1/2 IN signal cannot be displayed, try the following. <ul style="list-style-type: none"> - Reinstall your driver for the graphics card built in your computer, or use the updated driver. For reinstalling or updating your driver, refer to the user guide accompanied with your computer or graphics card, or contact the support center for your computer manufacturer. Install the updated driver or OS on your own responsibility. We are not liable for any trouble and failure caused by this installation. • Signals may not be supported depending on the HDBaseT transmission device. IR and RS232C cannot be used in certain cases as well. • See also the page 164.
The image is distorted.	<ul style="list-style-type: none"> • Check to see if the protractor is properly set up.
The image is blurred.	<ul style="list-style-type: none"> • Make certain that the lens is properly focused. • Check to see if the screen and a projector are installed at correct angles. • The projection distance may be larger than the focusing range. • Has the lens been shifted by an amount exceeding the guaranteed range? (→ page 147) • See if the lens and other parts have condensation on them. If the projector is turned on in a warm place after storage in a cold place, the lens and other optical components inside may develop condensation. In such a case, please wait several minutes until the condensation disappears.
Video image is disturbed.	<ul style="list-style-type: none"> • Check whether the signal cable connected to the projector is disconnected.
Remote control does not work	<ul style="list-style-type: none"> • Install new batteries. (→ page 13) • Make sure there are no obstacles between you and the projector. • Stand within 42.21 ft (15 m) of the projector. (→ page 14)
Indicator is lit or blinking	<ul style="list-style-type: none"> • See the POWER/STATUS/LIGHT/TEMP./SHUTTER/KEY LOCK Indicator. (→ page 165, 166)
An error code is displayed.	<ul style="list-style-type: none"> • Please contact your dealer/distributor for instructions.

If there is no picture, or the picture is not displayed correctly.

- Power on process for the projector and the PC.

Be sure to connect the projector and notebook PC while the projector is in standby mode and before turning on the power to the notebook PC.

In most cases the output signal from the notebook PC is not turned on unless connected to the projector before being powered up.

NOTE: You can check the horizontal frequency of the current signal in the projector's menu under Information. If it reads "0kHz", this means there is no signal being output from the computer. (→ page 132 or go to next step)

- Enabling the computer's external display.

Displaying an image on the notebook PC's screen does not necessarily mean it outputs a signal to the projector. When using a PC compatible laptop, a combination of function keys will enable/disable the external display. Usually, the combination of the "Fn" key along with one of the 12 function keys gets the external display to come on or off. For example, NEC laptops use Fn + F3, while Dell laptops use Fn + F8 key combinations to toggle through external display selections.

- Non-standard signal output from the computer

If the output signal from a notebook PC is not an industry standard, the projected image may not be displayed correctly. Should this happen, deactivate the notebook PC's LCD screen when the projector display is in use. Each notebook PC has a different way of deactivate/reactivate the local LCD screens as described in the previous step. Refer to your computer's documentation for detailed information.

- Image displayed is incorrect when using a Mac

When using a Mac with the projector, set the DIPswitch of the Mac adapter (not supplied with the projector) according to your resolution. After setting, restart your Mac for the changes to take affect.

For setting display modes other than those supported by your Mac and the projector, changing the DIP switch on a Mac adapter may bounce an image slightly or may display nothing. Should this happen, set the DIP switch to the 13" fixed mode and then restart your Mac. After that, restore the DIP switches to a displayable mode and then restart the Mac again.

NOTE: A Video Adapter cable manufactured by Apple Computer is needed for a MacBook which does not have a mini D-Sub 15-pin connector.

- Mirroring on a MacBook

* When using the projector with a MacBook, output may not be set to 4096 × 2160 unless "mirroring" is off on your MacBook. Refer to owner's manual supplied with your Mac computer for mirroring.

- Folders or icons are hidden on the Mac screen

Folders or icons may not be seen on the screen. Should this happen, select [View] → [Arrange] from the Apple menu and arrange icons.

10 Indicator Messages

This section helps you resolve problems you may encounter while setting up or using the projector.

POWER Indicator

Indicator display		Projector status	Procedure
Off		Power is off.	–
Flashing	Green (short flashes)	Preparing to power up or cooling the main unit When the projector is in the standby state, the firmware is ready to be updated	Wait a while.
	Green (twice per cycle)	Firmware is ready to be updated	–
	Green (long flashes)	Off timer (enabled) Program timer (off time enabled)	–
	Orange (long flashes)	Program timer (on time enabled)	–
Lit	Green	Power on	–
	Orange	Standby mode	–

STATUS Indicator

Indicator display		Projector status	Procedure
Off		No problem	–
Flashing	Green (short flashes)	Shutter is closed	–
	Green (long flashes)	Power on (The light module is turned off.)	–
	Orange	Button has been pressed while projector is in key lock mode	The projector's keys are locked. The setting must be canceled to operate the projector. (→ page 36, 119)
		Projector's ID number and remote control's ID number do not match	Check the control IDs. (→ page 120)
		Projector cooling	Wait a while.
	Red	Error occurring	Contact your distributor or service personnel. Let us know the details displayed on the liquid crystal indicator panel then.
Lit	Green	Power on	–
	Orange	Standby mode	–
	Red	Error requiring service support	Ask your distributor or service personnel for repair. Let us know the details displayed on the liquid crystal indicator panel then.

LIGHT Indicator

Indicator display		Projector status	Procedure
Off		The light module is turned off.	–
Lit	Green	Light module lit	–

TEMP. Indicator

Indicator display		Projector status	Procedure
Off		No problem	
Flashing	Red	Temperature problem	Ambient temperature is out of the operation temperature. Check if any obstruction stays near the exhaust vent.
Lit	Red	High surrounding temperature	The surrounding temperature is high. Lower the room temperature.

SHUTTER Indicator

Indicator display		Projector status
Off		Shutter is open.
Flashing	Green	Performing the lens calibration.
	Orange	Lens calibration implement request.
Lit	Green	Shutter is closed.
	Orange	On screen muting

KEY LOCK Indicator

Indicator display		Projector status
Off		[CONTROL PANEL LOCK] [OFF]
Lit	Orange	[CONTROL PANEL LOCK] [ON]

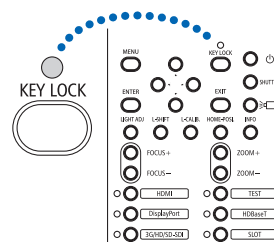

REAR LED

When [REAR LED] under [NOTIFICATION SETTINGS] is set to [ON], the operation is as shown below. When set to [OFF], the rear LED is always off.

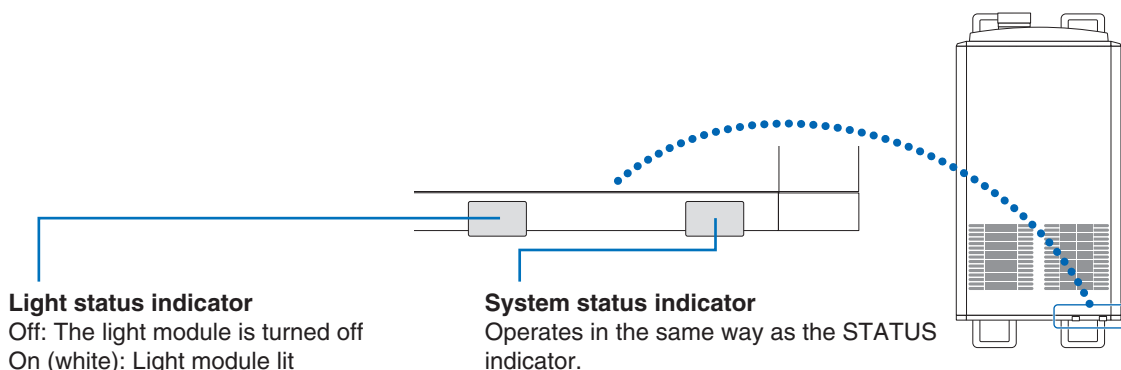

If the temperature protector is activated

If the projector's internal temperature rises abnormally, the light module turns off and the temperature indicator flashes. It may happen that the projector's temperature protector is simultaneously activated and the projector's power turns off. If this happens, do the following:

- Unplug the power cable from the power outlet.
- If using in a place where the surrounding temperature is high, move the projector to a different, cool place.
- If there is dust in the ventilation holes, clean. (→ page [138](#))
- Wait as such about 1 hour for the projector's internal temperature to lower.

11 Troubleshooting Check List

Before contacting your distributor or service personnel, check the following list to be sure repairs are needed also by referring to the “Troubleshooting” section in your user’s manual. This checklist below will help us solve your problem more efficiently.

* Print this page and the next page for your check.

Frequency of occurrence always sometimes (How often? _____) other (_____)

Power

- No power (POWER indicator does not light blue). See also “Status Indicator (STATUS)”.
- Power cord’s plug is fully inserted into the wall outlet.
- No power even though you press and hold the POWER button.
- The main power switch is in the “ON (I)” position.
- Shut down during operation.
 - Power cord’s plug is fully inserted into the wall outlet.
 - [AUTO POWER OFF] is turned off (only models with the [AUTO POWER OFF] function).
 - [OFF TIMER] is turned off (only models with the [OFF TIMER] function).

Video and Audio

- No image is displayed from your PC or video equipment to the projector.
 - Still no image even though you connect the projector to the PC first, then start the PC.
 - Enabling your notebook PC’s signal output to the projector.
 - *A combination of function keys will enable/disable the external display. Usually, the combination of the “Fn” key along with one of the 12 function keys turns the external display on or off.*
 - No image (blue or black background, no display).
 - Still no image even though you press the AUTO ADJUST button.
 - Still no image even though you carry out [RESET] in the projector’s menu.
 - Signal cable’s plug is fully inserted into the input terminal
 - A message appears on the screen.
(_____)
 - The source connected to the projector is active and available.
 - Still no image even though you adjust the brightness and/or the contrast.
 - Input source’s resolution and frequency are supported by the projector.
- Image is too dark.
 - Remains unchanged even though you adjust the brightness and/or the contrast.
- Image is distorted.
 - Image appears to be trapezoidal (unchanged even though you carry out the [KEYSTONE] adjustment).
- Parts of the image are lost.
 - Still unchanged even though you press the AUTO ADJUST button.
 - Still unchanged even though you carry out [RESET] in the projector’s menu.
- Image is shifted in the vertical or horizontal direction.
 - Horizontal and vertical positions are correctly adjusted on a computer signal.
 - Input source’s resolution and frequency are supported by the projector.
 - Some pixels are lost.
- Image is flickering.
 - Still unchanged even though you press the AUTO ADJUST button.
 - Still unchanged even though you carry out [RESET] in the projector’s menu.
 - Image shows flickering or color drift on a computer signal.
 - Still unchanged even though you change [FAN MODE] from [HIGH] to [AUTO].
- Image appears blurry or out of focus.
 - Still unchanged even though you checked the signal’s resolution on PC and changed it to projector’s native resolution.
 - Still unchanged even though you adjusted the focus.

Other

- Remote control does not work.
 - No obstacles between the sensor of the projector and the remote control.
 - Projector is placed near a fluorescent light that can disturb the infrared remote controls.
 - Batteries are new and are not reversed in installation.
- Buttons on the projector cabinet do not work (only models with the [CONTROL PANEL LOCK] function)
 - [CONTROL PANEL LOCK] is not turned on or is disabled in the menu.
 - Problem persists even when the KEY LOCK button on the projector cabinet is pressed for over 1 second.

In the space below please describe your problem in detail.

Information on application and environment where your projector is used

Projector

Model number:

Serial No.:

Date of purchase:

Light module operating time (hours):

Information on input signal:

Horizontal synch frequency [] kHz

Vertical synch frequency [] Hz

Synch polarity H (+) (-)

V (+) (-)

Synch type Separate Composite

Sync on Green

STATUS Indicator:

Steady light Orange Green

Flashing light [] cycles

Remote control model number:

Installation environment

Screen size: inch

Screen type: White matte Beads Polarization
 Wide angle High contrast

Throw distance: feet/inch/m

Orientation: Ceiling mount Desktop

Power outlet connection:

Connected directly to wall outlet

Connected to power cord extender or other (the number of connected equipment _____)

Connected to a power cord reel or other (the number of connected equipment _____)

Computer

Manufacturer:

Model number:

Notebook PC / Desktop

Native resolution:

Refresh rate:

Video adapter:

Other:

Video equipment

VCR, Blu-ray player, Video camera, Video game or other

Manufacturer:

Model number:

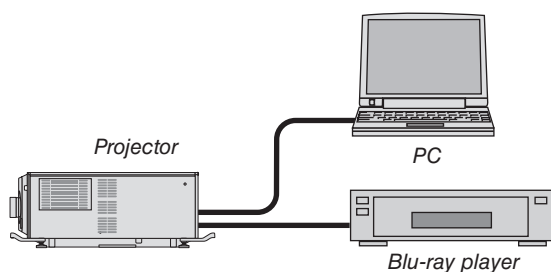

Signal cable

NEC standard or other manufacturer's cable?

Model number: Length: inch/m

Distribution amplifier

Model number:

Switcher

Model number:

Adapter

Model number:

12 GPL/LGPL Software Licenses

The product includes software licensed under GNU General Public License (GPL), GNU Lesser General Public License (LGPL), and others.

For more information on each software, see “readme.pdf” inside the “about GPL&LGPL” folder in the CD-ROM supplied with the LV Kit.

13 REGISTER YOUR PROJECTOR! (for residents in the United States, Canada, and Mexico)

Please take time to register your new projector. This will activate your limited parts and labor warranty and InstaCare service program.

Visit our web site at www.necdisplay.com, click on support center/register product and submit your completed form online.

Upon receipt, we will send a confirmation letter with all the details you will need to take advantage of fast, reliable warranty and service programs from the industry leader, NEC Display Solutions of America, Inc.

NEC