

Projector

PA803UL/PA653UL

User's Manual

Please visit our web site for User's Manual in the latest version:
http://www.nec-display.com/dl/en/pj_manual/lineup.html

Model No.
NP-PA803UL/NP-PA653UL

- Apple, Mac, Mac OS, and MacBook are trademarks of Apple Inc. registered in the U.S. and other countries.
- Microsoft, Windows, Windows Vista, Internet Explorer, .NET Framework and PowerPoint are either a registered trademark or trademark of Microsoft Corporation in the United States and/or other countries.
- MicroSaver is a registered trademark of Kensington Computer Products Group, a division of ACCO Brands.
- Adobe, Adobe PDF, Adobe Reader, and Acrobat are either registered trademarks or trademarks of Adobe Systems Incorporated in the United States and/or other countries.
- AccuBlend, NaViSet, and Virtual Remote are trademarks or registered trademarks of NEC Display Solutions, Ltd. in Japan, in the United State and other countries.
- The terms HDMI and HDMI High-Definition Multimedia Interface, and the HDMI Logo are trademarks or registered trademarks of HDMI Licensing, LLC in the United States and other countries.



- DisplayPort and DisplayPort Compliance Logo are trademarks owned by the Video Electronics Standards Association.



- HDBaseT™ is a trademark of HDBaseT Alliance.



- Trademark PJLink is a trademark applied for trademark rights in Japan, the United States of America and other countries and areas.
- Blu-ray is a trademark of Blu-ray Disc Association.
- CRESTRON and ROOMVIEW are registered trademarks of Crestron Electronics, Inc. in the United States and other countries.
- Extron and XTP are registered trademarks of RGB Systems, Inc. in the United States.
- Ethernet is either a registered trademark or trademark of Fuji Xerox Co., Ltd.
- Other product and company names mentioned in this user's manual may be the trademarks or registered trademarks of their respective holders.
- Virtual Remote Tool uses WinI2C/DDC library, © Nicomsoft Ltd.

NOTES

- (1) The contents of this user's manual may not be reprinted in part or whole without permission.
- (2) The contents of this user's manual are subject to change without notice.
- (3) Great care has been taken in the preparation of this user's manual; however, should you notice any questionable points, errors or omissions, please contact us.
- (4) Notwithstanding article (3), NEC will not be responsible for any claims on loss of profit or other matters deemed to result from using the Projector.

Important Information

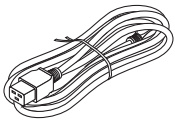

Please use the power cord supplied with this projector. If the supplied power cord does not satisfy requirements of your country's safety standard, and voltage and current for your region, make sure to use the power cord that conforms to and satisfies them.

- The power cord you use must be approved by and comply with the safety standards of your country. Please refer to the page [159](#) about the power cord specification.

Rated voltage by country is listed below for your reference. For selecting an appropriate power cord, please check rated voltage for your region by yourself.

AC 230 V : European countries
AC 120 V : North America

Safety Cautions

Precautions

Please read this manual carefully before using your NEC projector and keep the manual handy for future reference.

CAUTION



To turn off main power, be sure to remove the plug from power outlet.

The power outlet socket should be installed as near to the equipment as possible, and should be easily accessible.

CAUTION



TO PREVENT SHOCK, DO NOT OPEN THE CABINET.

THERE ARE HIGH-VOLTAGE COMPONENTS INSIDE.

REFER SERVICING TO QUALIFIED SERVICE PERSONNEL.



This symbol warns the user that uninsulated voltage within the unit may be sufficient to cause electrical shock. Therefore, it is dangerous to make any kind of contact with any part inside of the unit.



This symbol alerts the user that important information concerning the operation and maintenance of this unit has been provided.

The information should be read carefully to avoid problems.

WARNING: TO PREVENT FIRE OR SHOCK, DO NOT EXPOSE THIS UNIT TO RAIN OR MOISTURE. DO NOT USE THIS UNIT'S PLUG WITH AN EXTENSION CORD OR IN AN OUTLET UNLESS ALL THE PRONGS CAN BE FULLY INSERTED.

Machine Noise Information Regulation - 3. GPSGV,

The highest sound pressure level is less than 70 dB (A) in accordance with EN ISO 7779.

CAUTION



Avoid displaying stationary images for a prolonged period of time.

Doing so can result in these images being temporarily sustained on the surface of the LCD panel.

If this should happen, continue to use your projector. The static background from previous images will disappear.

Disposing of your used product



In the European Union

EU-wide legislation as implemented in each Member State requires that used electrical and electronic products carrying the mark (left) must be disposed of separately from normal household waste. This includes projectors and their electrical accessories. When you dispose of such products, please follow the guidance of your local authority and/or ask the shop where you purchased the product.

After collecting the used products, they are reused and recycled in a proper way. This effort will help us reduce the wastes as well as the negative impact to the human health and the environment at the minimum level. The mark on the electrical and electronic products only applies to the current European Union Member States.

Outside the European Union

If you wish to dispose of used electrical and electronic products outside the European union, please contact your local authority and ask for the correct method of disposal.



For EU: The crossed-out wheeled bin implies that used batteries should not be put to the general household waste! There is a separate collection system for used batteries, to allow proper treatment and recycling in accordance with legislation.

According to the EU directive 2006/66/EC, the battery can't be disposed improperly. The battery shall be separated to collect by local service.

WARNING TO CALIFORNIA RESIDENTS:

Handling the cables supplied with this product will expose you to lead, a chemical known to the State of California to cause birth defects or other reproductive harm. WASH HANDS AFTER HANDLING.

DOC Compliance Notice (for Canada only)

This Class A digital apparatus complies with Canadian ICES-003.

WARNING:

This equipment is compliant with Class A of CISPR 32. In a residential environment this equipment may cause radio interference.

CAUTION

- In order to reduce any interference with radio and television reception use a signal cable with ferrite core attached. Use of signal cables without a ferrite core attached may cause interference with radio and television reception.
- This equipment has been tested and found to comply with the limits for a Class A digital device, pursuant to Part 15 of the FCC Rules. These limits are designed to provide reasonable protection against harmful interference when the equipment is operated in a commercial environment. This equipment generates, uses, and can radiate radio frequency energy and, if not installed and used in accordance with the installation manual, may cause harmful interference to radio communications. Operation of this equipment in a residential area is likely to cause harmful interference in which case the user will be required to correct the interference at his own expense.

Important Safeguards

These safety instructions are to ensure the long life of your projector and to prevent fire and shock. Please read them carefully and heed all warnings.

Installation

- Do not place the projector in the following conditions:
 - on an unstable cart, stand, or table.
 - near water, baths, or damp rooms.
 - in direct sunlight, near heaters, or heat radiating appliances.
 - in a dusty, smoky or steamy environment.
 - on a sheet of paper or cloth, rugs or carpets.
- Do not install and store the projector in the below circumstances. Failure to do so may cause of malfunction.
 - In powerful magnetic fields
 - In corrosive gas environment
 - Outdoors
- If you wish to have the projector installed on the ceiling:
 - Do not attempt to install the projector yourself.
 - The projector must be installed by qualified technicians in order to ensure proper operation and reduce the risk of bodily injury.
 - In addition, the ceiling must be strong enough to support the projector and the installation must be in accordance with any local building codes.
 - Please consult your dealer for more information.

WARNING

- Do not cover the lens with the lens cap or equivalent while the projector is on. Doing so can lead to melting of the cap due to the heat emitted from the light output.
- Do not place any objects, which are easily affected by heat, in front of the projector lens. Doing so could lead to the object melting from the heat that is emitted from the light output.

The below pictogram indicated on the cabinet means the precaution for avoiding to place objects in front of the projector lens.

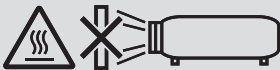

⚠ Fire and Shock Precautions ⚠

- Ensure that there is sufficient ventilation and that vents are unobstructed to prevent the build-up of heat inside your projector. Allow enough space between your projector and a wall. (→ page xi)
- Prevent foreign objects such as paper clips and bits of paper from falling into your projector. Do not attempt to retrieve any objects that might fall into your projector. Do not insert any metal objects such as a wire or screwdriver into your projector. If something should fall into your projector, disconnect it immediately and have the object removed by a qualified service personnel.
- Do not place any objects on top of the projector.
- Do not touch the power plug during a thunderstorm. Doing so may cause electrical shock.
- The projector is designed to operate on a power supply of 100-240V AC 50/60 Hz. Ensure that your power supply fits this requirement before attempting to use your projector.
- Make sure to mount the power cord stopper before attempting to use your projector. Please refer to page 15 about the power cord stopper.
- Do not look into the light source using optical instruments (such as magnifying glasses and mirrors). Visual impairment could result.
- When turning on the projector, ensure that nobody is facing towards the lens in the path of the light emitted from the laser. Do not look into the lens while the projector is on. Serious damage to your eyes could result. The following label, that is indicated at the lens-mounting-section on the projector cabinet, describes this projector is categorized in the risk group 2 of IEC 62471-5:2015. As with any bright light source, do not stare into the beam, RG2 IEC 62471-5:2015.

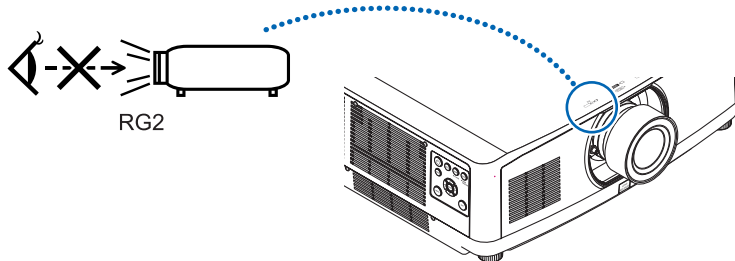

- Perform the adjustment from behind or from the side of the projector. Adjusting from the front could expose your eyes to strong light which could injure them.
- Keep any items (magnifying glass etc.) out of the light path of the projector. The light path being projected from the lens is extensive, therefore any kind of abnormal objects that can redirect light coming out of the lens, can cause an unpredictable outcome such as a fire or injury to the eyes.
- Do not place any objects, which are easily affected by heat, in front of a projector exhaust vent. Doing so could lead to the object melting or getting your hands burned from the heat that is emitted from the exhaust vent.
- Handle the power cord carefully. A damaged or frayed power cord can cause electric shock or fire.
 - Do not bend or tug the power cord excessively.
 - Do not place the power cord under the projector, or any heavy object.
 - Do not cover the power cord with other soft materials such as rugs.
 - Do not heat the power cord.
 - Do not handle the power plug with wet hands.
- Turn off the projector, unplug the power cord and have the projector serviced by a qualified service personnel under the following conditions:
 - When the power cord or plug is damaged or frayed.
 - If liquid has been spilled into the projector, or if it has been exposed to rain or water.
 - If the projector does not operate normally when you follow the instructions described in this user's manual.
 - If the projector has been dropped or the cabinet has been damaged.
 - If the projector exhibits a distinct change in performance, indicating a need for service.
- Disconnect the power cord and any other cables before carrying the projector.
- Turn off the projector and unplug the power cord before cleaning the cabinet or cleaning or replacing the lens.
- Turn off the projector and unplug the power cord if the projector is not to be used for an extended period of time.
- When using a LAN cable:
For safety, do not connect to the connector for peripheral device wiring that might have excessive voltage.
- Do not use the malfunctioned projector. It may cause of not only electric shock or fire but also serious damage to your eye sight.

- Do not let children to operate the projector by themselves. If the projector is operated by children, adults need to attend and keep their eyes on children.
- If damage or malfunction of the projector is found, immediately stop to use it and consult your dealer for repair.
- Never disassemble, repair, and remodel by end users. If these are performed by end users, it may cause of serious problem on users' safety.
- Consult your dealer for disposing the projector. Never disassemble the projector before disposing it.

CAUTION

- Do not use the tilt-foot for purposes other than originally intended. Misuses such as gripping the tilt-foot or hanging on the wall can cause damage to the projector.
- Do not hold the cable cover while moving the projector or do not apply excessive force to the cable cover. Doing so may damage the cable cover, resulting in injury.
- Be sure to tighten the screws after attaching the cable cover. Failure to do so may cause the cable cover to come off and fall, resulting in injury or damage to the cable cover.
- Do not put bundled cables in the cable cover. Doing so may damage the power cord, resulting in a fire.
- Select [HIGH] in Fan mode if you continue to use the projector for consecutive days. (From the menu, select [SETUP] → [OPTIONS(1)] → [FAN MODE] → [MODE] → [HIGH].)
- Do not unplug the power cable from the wall outlet or projector when the projector is powered on. Doing so can cause damage to the AC IN terminal of the projector and (or) the prong plug of the power cable.
To turn off the AC power supply under the state the projector is ON, use a power strip equipped with a switch and a breaker.
- A minimum of two persons are required to carry the projector. Otherwise the projector may tumble or drop, causing personal injury.

Caution on Handling the Optional Lens

When shipping the projector with the lens, remove the lens before shipping the projector. Always attach the dust cap to the lens whenever it is not mounted on the projector. The lens and the lens shift mechanism may encounter damage caused by improper handling during transportation.

Do not hold the lens part when carrying the projector.

Doing so could cause the focus ring to rotate, resulting in accidental dropping of the projector.

In the condition the projector is no lens mounted, do not put your hands in the lens mount opening for carrying the projector.

Keep hands away from the lens mounting portion while performing a lens shift. Failure to do so could result in fingers being pinched by the moving lens.

Remote Control Precautions

- Handle the remote control carefully.
- If the remote control gets wet, wipe it dry immediately.
- Avoid excessive heat and humidity.
- Do not short, heat, or take apart batteries.
- Do not throw batteries into fire.
- If you will not be using the remote control for a long time, remove the batteries.
- Ensure that you have the batteries' polarity (+/-) aligned correctly.
- Do not use new and old batteries together, or use different types of batteries together.
- Dispose of used batteries according to your local regulations.
- Replace two batteries at the same time with the quite same ones that has been installed in the remote control or AA sized alkalis battery that is conformed to IEC 60086-5.

About High Altitude mode

- Set [FAN MODE] to [HIGH ALTITUDE] when using the projector at altitudes approximately 5500 feet/1700 meters or higher.

Using the projector at altitudes approximately 5500 feet/1700 meters or higher without setting to [HIGH ALTITUDE] can cause the projector to overheat and the protector could shut down. If this happens, wait a couple minutes and turn on the projector.

Important Information

- Using the projector at altitudes less than approximately 5500 feet/1700 meters and setting to [HIGH ALTITUDE] can cause the light module to overcool, causing the image to flicker. Switch [FAN MODE] to [AUTO].
- Using the projector at altitudes approximately 5500 feet/1700 meters or higher can shorten the life of optical components such as the light module.

Light Module

1. A light module containing multiple laser diodes is equipped in the product as the light source.
2. These laser diodes are sealed in the light module. No maintenance or service is required for the performance of the light module.
3. End user is not allowed to replace the light module.
4. Contact qualified distributor for light module replacement and further information.

Laser Safety Caution

• For USA

This product is classified as Class 3R of IEC 60825-1 Second edition 2007-03

Complies with FDA performance standards for laser products except for deviations pursuant to Laser Notice No. 50, dated June 24, 2007.

For other regions

This product is classified as Class 1 of IEC 60825-1 Third edition 2014-05 and RG2 of IEC 62471-5 First edition 2015-06.

Obey the laws and regulations of your country in relation to the installation and management of the device.

- Outline of laser emitted from the built-in light module:
 - Wave length: 455 nm
 - Maximum power: 140 W (PA653UL), 168 W (PA803UL)
- Radiation pattern from the protective housing:
 - Wave length: 455 nm
 - Maximum laser radiation output: 333 mW
- The laser module is equipped in this product. Use of controls or adjustments of procedures other than those specified herein may result in hazardous radiation exposure.

CAUTION

- Use of controls or adjustments or performance of procedures other than those specified herein may result in hazardous radiation exposure.

CAUTION – CLASS 3R OF IEC 60825-1 SECOND EDITION LASER PRODUCT

LASER LIGHT – AVOID DIRECT EYE EXPOSURE

Applicable lens unit: NP40ZL/NP41ZL/NP42ZL

Horizontal angle (unit: degree)

Lens unit	Zoom	Lens position		
		Right most	Center (Reference value)	Left most
		HR	HC	HL
NP40ZL	Tele	31.7	23.8	31.7
	Wide	41.0	31.9	41.0
NP41ZL	Tele	12.8	9.2	12.8
	Wide	27.7	20.6	27.7
NP42ZL	Tele	6.6	4.7	6.6
	Wide	12.9	9.3	12.9

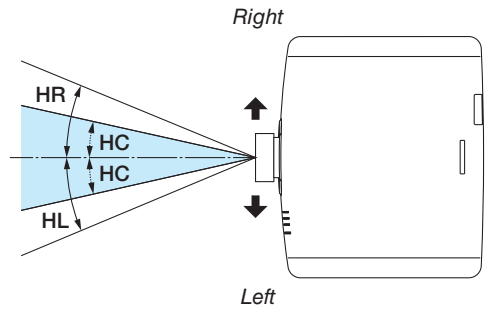

Vertical angle (unit: degree)

Lens unit	Zoom	Lens position		
		Upper most	Center (Reference value)	Lower most
		VU	VC	VD
NP40ZL	Tele	29.3	18.3	21.6
	Wide	38.4	25.0	29.2
NP41ZL	Tele	11.7	6.9	8.3
	Wide	25.6	15.7	18.7
NP42ZL	Tele	6.0	3.5	4.2
	Wide	11.8	7.0	8.4

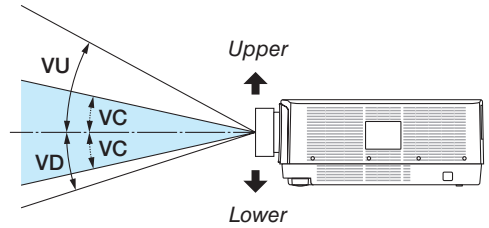

Important Information

- The caution and the explanatory labels of the LASER PRODUCT in CLASS 3R conforming to IEC 60825-1 Second edition, and in Class 1 conforming to IEC 60825-1 Third edition are stuck on the below indicated positions.

For USA

Label 1

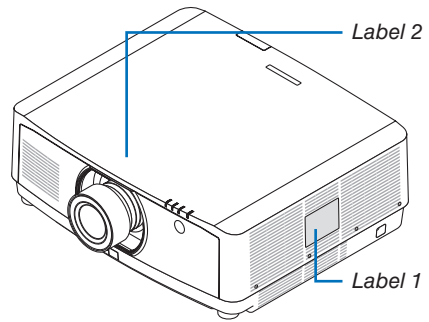
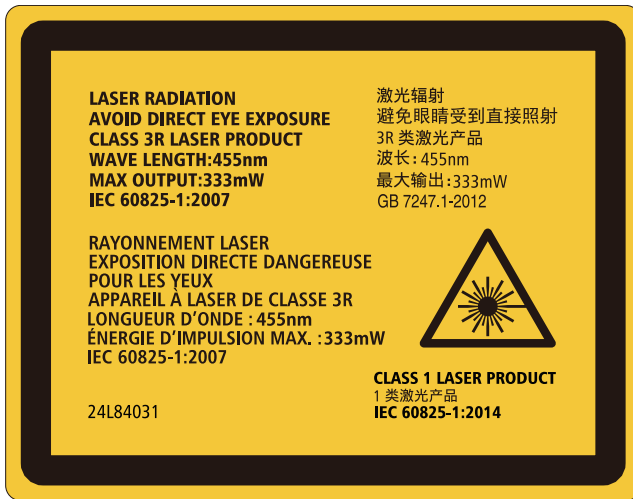

Label 2





For other regions

Label 1





• **Manufacturer's ID Label (for USA)**

(For PA803UL)

<p>NEC MODEL No. NP-PA803UL 100-240V~ 50/60Hz 11.8-5.2A</p>		<p>CAN ICES-3(A)/NMB-3(A)</p>
 <p>I.T.E. 4ZDB E359310</p>	<p>720SS</p> 	<p>THIS DEVICE COMPLIES WITH PART 15 OF THE FCC RULES. OPERATION IS SUBJECT TO THE FOLLOWING TWO CONDITIONS:(1) THIS DEVICE MAY NOT CAUSE HARMFUL INTERFERENCE, AND (2) THIS DEVICE MUST ACCEPT ANY INTERFERENCE RECEIVED, INCLUDING INTERFERENCE THAT MAY CAUSE UNDESIRE OPERATION.</p>
<p>CAUTION : TO PREVENT ELECTRIC SHOCK, DO NOT OPEN TOP COVER. NO USER-SERVICEABLE PARTS INSIDE.</p> <p>ATTENTION : AFIN DE PREVENIR UN CHOC ELECTRIQUE NE PAS ENLEVER LE COUVERCLE S'ADRESSER A UN REPARATEUR COMPETENT.</p> <p>WARNING : TO REDUCE THE RISK OF FIRE OR ELECTRIC SHOCK, DO NOT EXPOSE THIS APPLIANCE TO RAIN OR MOISTURE.</p> <p>AVERTISSEMENT : POUR EVITER UN FEU OU UN RISQUE D'ELECTROCUTION NE PAS EXPOSER CET ENSEMBLE A LA PLUIE OU A L'HUMIDITE.</p>	<p>Complies with FDA performance standards for laser products except for deviations pursuant to Laser Notice No. 50, dated June 24, 2007.</p> <p>THIS CABINET IS CONSTRUCTED OF PLASTIC (PC).</p> <p>NEC Display Solutions, Ltd. 4-28, Mita 1-chome, Minato-ku, Tokyo, Japan MADE IN CHINA</p>	 <p>24L84351 U</p>

(For PA653UL)

<p>NEC MODEL No. NP-PA653UL 100-240V~ 50/60Hz 10.2-4.5A</p>		<p>CAN ICES-3(A)/NMB-3(A)</p>
 <p>I.T.E. 4ZDB E359310</p>	<p>720SS</p> 	<p>THIS DEVICE COMPLIES WITH PART 15 OF THE FCC RULES. OPERATION IS SUBJECT TO THE FOLLOWING TWO CONDITIONS:(1) THIS DEVICE MAY NOT CAUSE HARMFUL INTERFERENCE, AND (2) THIS DEVICE MUST ACCEPT ANY INTERFERENCE RECEIVED, INCLUDING INTERFERENCE THAT MAY CAUSE UNDESIRE OPERATION.</p>
<p>CAUTION : TO PREVENT ELECTRIC SHOCK, DO NOT OPEN TOP COVER. NO USER-SERVICEABLE PARTS INSIDE.</p> <p>ATTENTION : AFIN DE PREVENIR UN CHOC ELECTRIQUE NE PAS ENLEVER LE COUVERCLE S'ADRESSER A UN REPARATEUR COMPETENT.</p> <p>WARNING : TO REDUCE THE RISK OF FIRE OR ELECTRIC SHOCK, DO NOT EXPOSE THIS APPLIANCE TO RAIN OR MOISTURE.</p> <p>AVERTISSEMENT : POUR EVITER UN FEU OU UN RISQUE D'ELECTROCUTION NE PAS EXPOSER CET ENSEMBLE A LA PLUIE OU A L'HUMIDITE.</p>	<p>Complies with FDA performance standards for laser products except for deviations pursuant to Laser Notice No. 50, dated June 24, 2007.</p> <p>THIS CABINET IS CONSTRUCTED OF PLASTIC (PC).</p> <p>NEC Display Solutions, Ltd. 4-28, Mita 1-chome, Minato-ku, Tokyo, Japan MADE IN CHINA</p>	 <p>24L84051 U</p>

About Copyright of original projected pictures:

Please note that using this projector for the purpose of commercial gain or the attraction of public attention in a venue such as a coffee shop or hotel and employing compression or expansion of the screen image with the following functions may raise concern about the infringement of copyrights which are protected by copyright law.

[ASPECT RATIO], [KEYSTONE], Magnifying feature and other similar features.

Turkish RoHS information relevant for Turkish market

EEE Yönetmeliğine Uygundur.



Health precautions to users viewing 3D images

Before viewing, be sure to read health care precautions that may be found in the user's manual included with your 3D eyeglasses or your 3D compatible content such as Blu-ray Discs, video games, computer's video files and the like. To avoid any adverse symptoms, heed the following:

- Do not use 3D eyeglasses for viewing any material other than 3D images.
- Allow a distance of 2 m/7 feet or greater between the screen and a user. Viewing 3D images from too close a distance can strain your eyes.
- Avoid viewing 3D images for a prolonged period of time. Take a break of 15 minutes or longer after every hour of viewing.
- If you or any member of your family has a history of light-sensitive seizures, consult a doctor before viewing 3D images.
- While viewing 3D images, if you get sick such as nausea, dizziness, queasiness, headache, eyestrain, blurry vision, convulsions, and numbness, stop viewing them. If symptoms still persist, consult a doctor.
- View 3D images from the front of the screen. Viewing from an angle may cause fatigue or eyestrain.

AUTO POWER OFF Function

The factory default setting for [AUTO POWER OFF] is 15 minutes. If no input signal is received and no operation is performed on the projector during 15 minutes, the projector is automatically powered off for saving the power consumption. In order to control the projector by an external device, set the [AUTO POWER OFF] to [OFF]. Please refer page [131](#) for details.

Clearance for Installing the Projector

Allow ample clearance between the projector and its surroundings as shown below. The high temperature exhaust coming out of the device may be sucked into the device again. Required clearance is same whenever the projector is installed in any angle.

Avoid installing the projector in a place where air movement from the HVAC is directed at the projector.

Heated air from the HVAC can be taken in by the projector's intake vent. If this happens, the temperature inside the projector will rise too high causing the over-temperature protector to automatically turn off the projector's power.

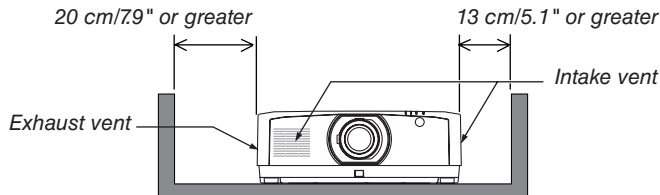

NOTE:

- The drawing shows the proper clearance required for the left and right of the projector assuming sufficient clearance has been kept for the front, back and top of the projector.
 - Please consider sufficient clearance to the projector rear side for setting the cable cover.
 - For the portrait projection, each required clearance between the floor and the intake or the exhaust vent is same with the clearance on the upper illustration. See page [148](#) for an installation example on portrait projection.
-

Table of Contents

Important Information	i
1. Introduction	1
① What's in the Box?	1
② Introduction to the Projector.....	2
General	2
Light source · Brightness	2
Installation.....	2
Videos.....	2
Network.....	3
Energy-saving	3
About this user's manual.....	4
③ Part Names of the Projector	5
Front/Top.....	5
Rear	6
Mounting the cable cover.....	7
Controls/Indicator Panel.....	8
Terminals	9
④ Part Names of the Remote Control.....	10
Battery Installation	11
Remote Control Precautions	11
Operating Range for Wireless Remote Control	12
2. Projecting an Image (Basic Operation)	13
① Flow of Projecting an Image	13
② Connecting Your Computer/Connecting the Power Cord	14
Using the power cord stopper	15
③ Turning on the Projector.....	16
Performing Lens Calibration	16
Note on Startup screen (Menu Language Select screen).....	17
④ Selecting a Source	18
⑤ Adjusting the Picture Size and Position	20
Adjusting the vertical position of a projected image (Lens shift)	21
Focus	22
Zoom.....	25
Adjusting the Tilt Foot.....	26
⑥ Optimizing Computer Signal Automatically	27
⑦ Turning Up or Down Volume	27
⑧ Turning off the Projector	28
⑨ After Use	29
3. Convenient Features	30
① Turn off the light of the projector (LENS SHUTTER).....	30
② Turning off the Image and Sound.....	30
③ Shift the On-Screen Menu displaying position.....	31
④ Freezing a Picture.....	32
⑤ Enlarging a Picture	32

⑥	Changing LIGHT MODE/Checking Energy-Saving Effect Using LIGHT MODE [LIGHT MODE].....	33
	Checking Energy-Saving Effect [CARBON METER].....	35
⑦	Correcting Horizontal and Vertical Keystone Distortion [CORNERSTONE].....	36
⑧	Operation for the On-Screen Menu by a commercially available USB mouse.....	38
	Menu operation.....	38
	Menu position control.....	39
	Geometric correction.....	39
⑨	Preventing the Unauthorized Use of the Projector [SECURITY].....	41
⑩	Projecting 3D videos.....	44
	Procedure to watch 3D videos using this projector.....	44
	When videos cannot be viewed in 3D.....	46
⑪	Controlling the Projector by Using an HTTP Browser.....	47
⑫	Storing Changes for Lens Shift, Zoom, and Focus [LENS MEMORY].....	54
	To store your adjusted values in [REF. LENS MEMORY]:.....	55
	To call up your adjusted values from [REF. LENS MEMORY]:.....	57
4.	Multi-Screen Projection	60
①	Things that can be done using multi-screen projection.....	60
	Case 1. Using a single projector to project two types of videos [PIP/PICTURE BY PICTURE].....	60
	Case 2. Using four projectors to project videos with a resolution of 3840 × 2160 pixels [TILING].....	61
	Things to note when installing projectors.....	63
②	Displaying Two Pictures at the Same Time.....	64
	Projecting two screens.....	65
	Switching the main display with the sub-display and vice versa.....	66
	Restrictions.....	67
③	Displaying a Picture Using [EDGE BLENDING].....	68
	Setting the overlap of projection screens.....	69
	[BLEND CURVE].....	71
	Black Level Adjustment.....	72
5.	Using On-Screen Menu	74
①	Using the Menus.....	74
②	Menu Elements.....	75
③	List of Menu Items.....	76
④	Menu Descriptions & Functions [INPUT].....	82
⑤	Menu Descriptions & Functions [ADJUST].....	86
	[PICTURE].....	86
	[IMAGE OPTIONS].....	90
	[VIDEO].....	94
	[3D SETTINGS].....	96
	Using the Lens Memory Function [LENS MEMORY].....	97
⑥	Menu Descriptions & Functions [DISPLAY].....	99
	[PIP/PICTURE BY PICTURE].....	99
	[GEOMETRIC CORRECTION].....	101
	[EDGE BLENDING].....	106
	[MULTI SCREEN].....	107

7	Menu Descriptions & Functions [SETUP]	109
	[MENU(1)]	109
	[MENU(2)]	110
	[INSTALLATION(1)]	111
	[INSTALLATION(2)]	115
	[CONTROL]	116
	[NETWORK SETTINGS]	123
	[SOURCE OPTIONS]	128
	[POWER OPTIONS]	130
	Returning to Factory Default [RESET]	132
8	Menu Descriptions & Functions [INFO.]	133
	[USAGE TIME]	133
	[SOURCE(1)]	134
	[SOURCE(2)]	134
	[SOURCE(3)]	134
	[SOURCE(4)]	135
	[WIRED LAN]	135
	[VERSION(1)]	135
	[OTHERS]	136
	[CONDITIONS]	136
	[HDBaseT]	137
6.	Connecting to Other Equipment	138
1	Mounting a lens (sold separately)	138
	Mounting the lens	138
	Removing the lens	140
2	Making Connections	141
	Analog RGB signal connection	141
	Digital RGB signal connection	142
	Connecting Component Input	144
	Connecting HDMI Input	145
	Connecting to a HDBaseT transmission device (sold commercially)	146
	Connecting several projectors	147
	Portrait projection (vertical orientation)	148
	Connecting to a Wired LAN	150
7.	Maintenance	151
1	Cleaning the Lens	151
2	Cleaning the Cabinet	151
8.	Appendix	152
1	Throw distance and screen size	152
	Lens types and throw distance	152
	Tables of screen sizes and dimensions	153
	Lens shifting range	153
2	Compatible Input Signal List	155
3	Specifications	158
4	Cabinet Dimensions	161
5	Pin assignments and signal names of main connectors	162

6	Changing the Background Logo (Virtual Remote Tool).....	164
7	Troubleshooting	165
	Feature of each indicator	165
	Indicator Message (Status message)	165
	Indicator Message (Error message).....	167
	Explanation on the POWER indicator and standby state.....	168
	Common Problems & Solutions	170
	If there is no picture, or the picture is not displayed correctly.....	172
8	PC Control Codes and Cable Connection	173
	ABOUT THE ASCII CONTROL COMMAND.....	174
9	Troubleshooting Check List.....	176
10	REGISTER YOUR PROJECTOR! (for residents in the United States, Canada, and Mexico)	178

1. Introduction

① What's in the Box?

Make sure your box contains everything listed. If any pieces are missing, contact your dealer. Please save the original box and packing materials if you ever need to ship your projector.

Projector

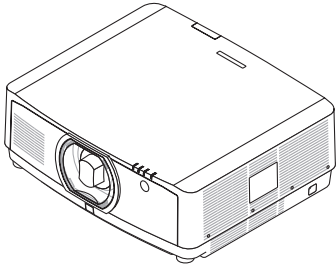

Dust cap for lens (24F54091)

* The projector is shipped without a lens. For the types of lens and throw distances, see page 152.

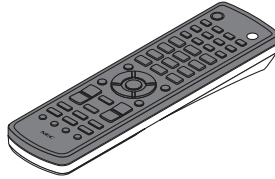

Remote control
(7N901081)

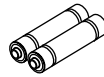

AA alkaline batteries
(x2)

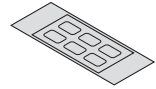

Input selection character sticker

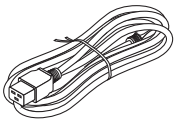

Power cord
(US: 7N080533)
(EU: 7N080030)

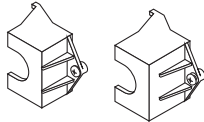

Power cord stopper
(24FU2631 for the power cord 7N080533)
(24FU2621 for the power cord 7N080030)
For the preventive measure from dropping off the power cord.

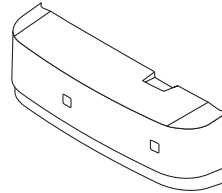

Cable cover
(24DU4661)



Lens theft prevention screw (24V00941)
This screw makes it difficult to remove the lens mounted on the projector. (→ page 139)

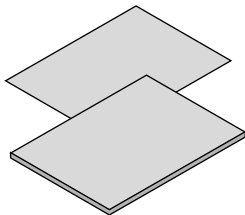

- Important Information (For North America: 7N8N7991)
- Quick Setup Guide (For North America: 7N8N8001) (For Other countries than North America: 7N8N8001 and 7N8N8011)
- Security Sticker (Use this sticker when security password is set on.)

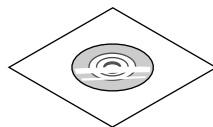

NEC Projector CD-ROM
User's manual (PDF)
(7N952581)

For North America only

Limited warranty

For customers in Europe:

You will find our current valid Guarantee Policy on our Web Site:

www.nec-display-solutions.com

② Introduction to the Projector

This section introduces you to your new projector and describes the features and controls.

General

- **Liquid crystal type high brightness/high resolution projector**

Model	Brightness	Resolution	Aspect Ratio
PA803UL	8000 lm	WUXGA (1920 × 1200)	16:10
PA653UL	6500 lm	WUXGA (1920 × 1200)	16:10

Light source • Brightness

- **A long-life laser diode is equipped in the light module**

The product can be operated at low cost because the laser light source can be used for a long time without requiring replacement or maintenance.

- **Brightness can be adjusted within a wide range**

Unlike with ordinary light sources, the brightness can be adjusted from 25 to 100% in 1% increments.

- **[CONSTANT BRIGHTNESS] mode**

Brightness normally decreases with use, but by selecting [CONSTANT BRIGHTNESS] mode, sensors inside the projector detect and automatically adjust the output, thereby maintaining constant brightness throughout the life of the light module.

However, if brightness output is set at the maximum, brightness will decrease with use.

Installation

- **Wide range of optional lenses selectable according to the place of installation**

This projector supports three types of optional lenses, providing a selection of lenses adapted to a variety of places of installation and projection methods.

In addition, the lenses can be mounted and removed in one touch.

Note that no lens is mounted upon shipment from the factory. Please purchase optional lenses separately.

- **Motorized lens control function for easily adjusting the position of the projected image**

The position of the projected image (lens shift), Zoom, and Focus can be adjusted by buttons either on the control panel on the side face of the cabinet or the remote control.

- **This projector can be installed universally in every angle**

For controlling fine inclination, use the tilt foot. Install an appropriate metal and a stand that has enough strength to support the projector for controlling the installation angle.

Videos

- **Wide range of input/output terminals (HDMI, DisplayPort, HDBaseT, etc.)**

The projector is equipped with a variety of input/output terminals: HDMI (input × 2), DisplayPort, HDBaseT (input × 1, output × 1), computer (analog), etc.

The projector's HDMI input, DisplayPort input terminals and HDBaseT Ports support HDCP.

- **HDMI and HDBaseT support HDCP 2.2/1.4**

- **DisplayPort supports HDCP 1.4**

- **Simultaneous display of 2 images (PIP/PICTURE BY PICTURE)**

Two images can be projected simultaneously with a single projector.

There are two types of layouts for the two images: "picture-in-picture" in which a sub-picture is displayed on the main picture, and "picture-by-picture" in which the main and sub pictures are displayed next to each other.

- **Multi-screen projection using multiple projectors**

This projector equips the HDBaseT IN/Ethernet and HDBaseT OUT/Ethernet ports. Multiple projectors in same brightness up to four units can be connected in a daisy chain by a LAN*1 cable via these terminals. A high quality picture is achieved by dividing and projecting high resolution videos among the various projectors.

Furthermore, the boundaries of the screens are smoothed using an edge blending function.

*1 Use a commercially available CAT 5e STP cable or one in a higher specification.

- **Seamless switch function for smoother screen changes when switching the signal**

When the input connector is switched, the image displayed before switching is held so that the new image can be switched to without a break due to absence of a signal.

- **Supports HDMI 3D format**

This projector can be used to watch videos in 3D using commercially-available active shutter-type 3D eyewear and 3D emitters that support Xpand 3D.

Network

- **Supports wired LAN**

Equips the LAN and HDBaseT/Ethernet (RJ-45) ports. Utilizing a wired LAN connected with these ports, it enables to control the projector by a computer.

- **CRESTRON ROOMVIEW and Extron XTP compatibility**

The projector supports CRESTRON ROOMVIEW and Extron XTP, allowing multiple devices connected in the network to be managed and controlled from a computer. Moreover, it enables to output and control image via an Extron XTP transmitter connected with the projector.

- **Convenient utility software (User Supportware) provided as standard**

This projector supports our utility software (NaViSet Administrator 2, Virtual Remote Tool, etc.).

NaViSet Administrator 2 helps you control the projector by a computer via wired LAN connection.

Virtual Remote Tool helps you perform operations by a virtual remote control such as projector's power on or off and signal selection via wired LAN connection. Moreover, it has function to send an image to the projector and register it as the logo data.

Please visit our web site for downloading each software.

URL: <http://www.nec-display.com/dl/en/index.html>

Energy-saving

- **Energy-saving design with a standby power consumption of 0.15 W (100-130 V AC) / 0.21 W (200-240 V AC)**

When the on-screen menu's standby mode is set to "NORMAL", the power consumption in the standby mode activating the Power Management is 0.15 W (100-130 V AC) / 0.21 W (200-240 V AC) and 0.11 W (100-130 V AC) / 0.16 W (200-240 V AC) when LAN is ineffective.

- **[LIGHT MODE] for low power consumption and "Carbon Meter" display**

The projector is equipped with an [LIGHT MODE] for reducing power consumption during use. Furthermore, the power-saving effect when one option among [ECO1], [ECO2] and [LONG LIFE] is set is converted into the amount of reductions of CO₂ emissions and this is indicated on the confirmation message displayed when the power is turned off and at [INFORMATION] on the on-screen menu (CARBON METER).

About this user's manual

The fastest way to get started is to take your time and do everything right the first time. Take a few minutes now to review the user's manual. This may save you time later on. At the beginning of each section of the manual you'll find an overview. If the section doesn't apply, you can skip it.

3 Part Names of the Projector

Front/Top

The lens is sold separately. The description below is for when the NP41ZL lens is mounted.

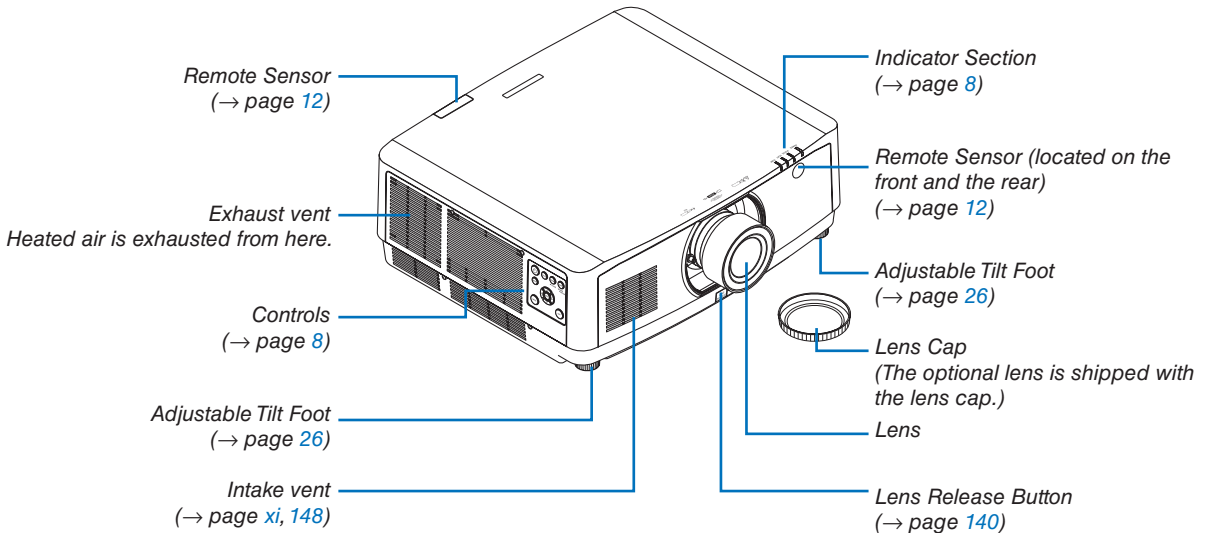

How to paste the input selection character sticker of the remote control

- **Peel off the cover of the sticker and align the sticker holes with Buttons 1 to 6 before pasting.**
 - Please take care not to let the sticker contact the buttons when pasting.
 - The explanations and illustrations in this manual are provided with the sticker pasted.

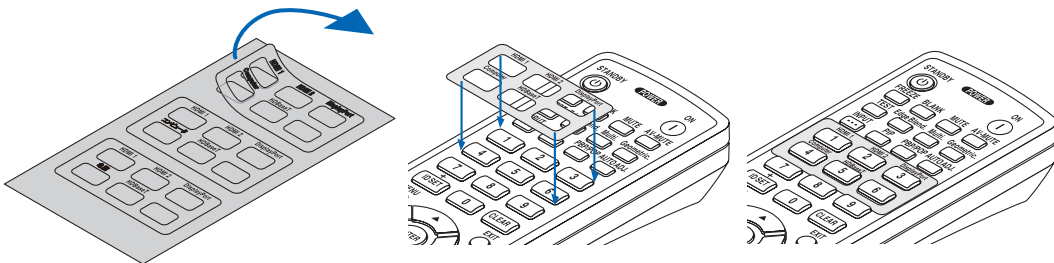

Rear

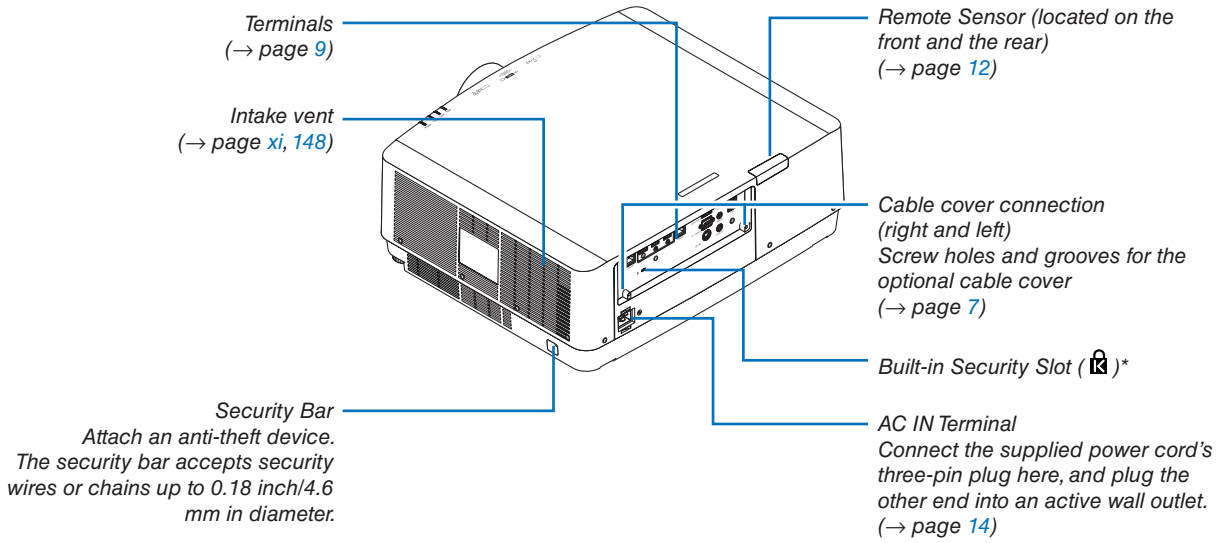

* This security slot supports the MicroSaver® Security System.

Mounting the cable cover

Mounting the cable cover on the projector allows you hide the cables for a tidy appearance.

CAUTION

- After mounting the cable cover, be sure to fasten using the screws provided. If not, the cable cover could fall and damage the cable cover and possibly resulting in injury.
- Do not bundle the power cord and place it under the cable cover. Doing so could lead to fire.
- Do not hold the cable cover while moving the projector and do not apply excessive force to the cable cover. Doing so could damage the cable cover, resulting in the projector falling or causing injury.

Mounting

Preparations:

1. Connect the power cord and cables to the projector (the connection cords are omitted from the diagrams).
2. Prepare a Phillips screwdriver.

1. **Insert the two round protrusions on the left and right edges of the cable cover into the grooves in the bottom of the projector to line it up.**

NOTE: Be careful not to let the power cord and cables get pinched by the cable cover.

2. **Turn the cable cover screw clockwise.**

- Tighten the screw securely.

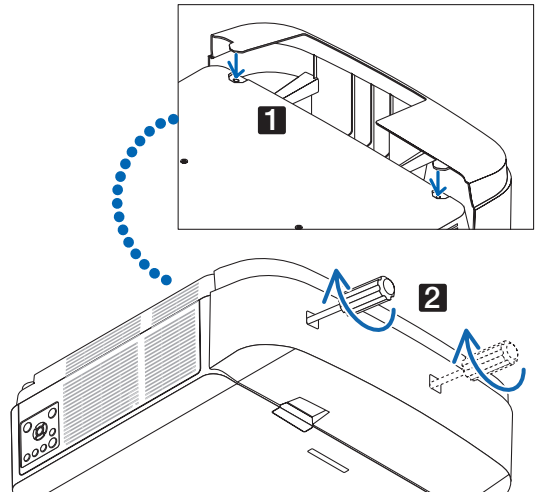

Removing

1. **Turn the cable cover screw counterclockwise until it turns loosely.**

- Hold the cable cover while doing this to prevent it from falling.
- The screw does not come completely off.

2. **Remove the cable cover.**

- Turn the cable cover a little, then lift it off.

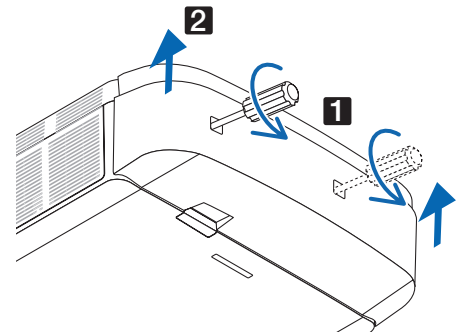

Controls/Indicator Panel

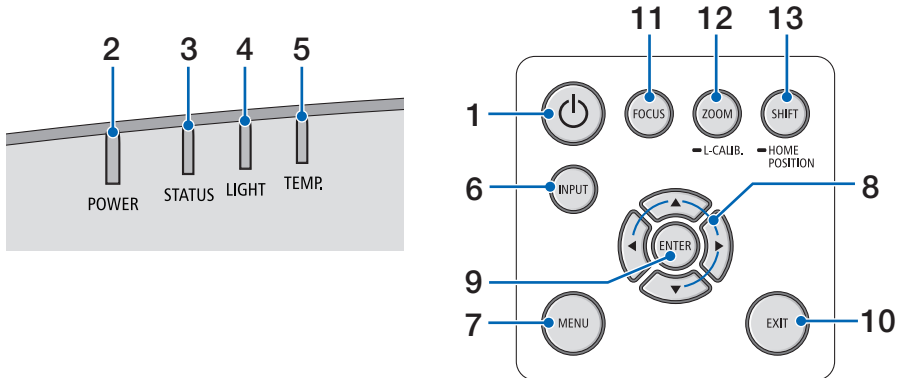

1. **⏻ (POWER) Button**
(→ page 16, 28)
2. **POWER Indicator**
(→ page 14, 16, 28, 165, 166, 167)
3. **STATUS Indicator**
(→ page 165, 166, 167)
4. **LIGHT Indicator**
(→ page 165, 166, 167)
5. **TEMP. Indicator**
(→ page 165, 166, 167)
6. **INPUT Button**
(→ page 18)
7. **MENU Button**
(→ page 74)
8. **▲▼◀▶ / Volume Buttons ◀▶**
(→ page 27, 74)
9. **ENTER Button**
(→ page 74)
10. **EXIT Button**
(→ page 74)
11. **FOCUS Button**
(→ page 23)
12. **ZOOM/L-CALIB. Button**
(→ page 25)
13. **SHIFT/HOME POSITION Button**
(→ page 21)

Terminals

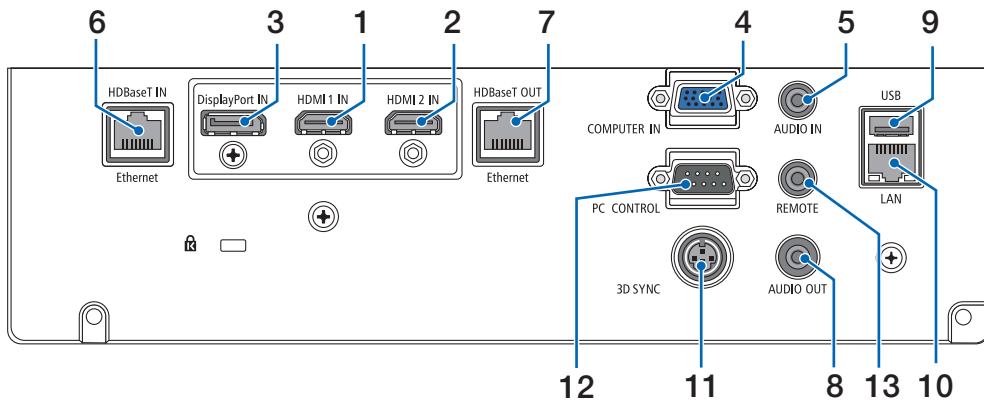
**1. HDMI 1 IN Terminal (Type A)**

(→ page 142, 143, 145)

2. HDMI 2 IN Terminal (Type A)

(→ page 142, 143, 145)

3. DisplayPort IN Terminal

(→ page 142)

4. COMPUTER IN/ Component Input Terminal (Mini D-Sub 15 Pin)

(→ page 141, 144)

5. COMPUTER AUDIO IN Mini Jack (Stereo Mini)

(→ page 141, 143)

6. HDBaseT IN/Ethernet Port (RJ-45)

(→ page 146, 147)

7. HDBaseT OUT/Ethernet Port (RJ-45)

(→ page 61, 147)

8. AUDIO OUT Mini Jack (Stereo Mini)

(→ page 141, 143, 145)

9. USB-A Port (Type A)

(→ page 38)

10. LAN Port (RJ-45)

(→ page 150)

11. 3D SYNC Terminal (Mini DIN 3 Pin)

(→ page 44)

12. PC CONTROL Port (D-Sub 9 Pin)

(→ page 163)

Use this port to connect a PC or control system. This enables you to control the projector using serial communication protocol. If you are writing your own program, typical PC control codes are on page 173.

13. REMOTE Terminal (Stereo Mini)

Use this terminal for wired remote control of the projector using the NEC remote control, RD-465E.

Connect the projector and our remote control, RD-465E, using a commercially available wired remote control cable.

NOTE:

- When a remote control cable is connected to the REMOTE terminal, infrared remote control operations cannot be performed.
- When [HDBaseT] is selected in the [REMOTE SENSOR] and the projector is connected to a commercially-available transmission device that supports HDBaseT, remote control operations in infra-red cannot be carried out if transmission of remote control signals has been set up in the transmission device. However, remote control using infrared rays can be carried out when the power supply of the transmission device is switched off.

4 Part Names of the Remote Control

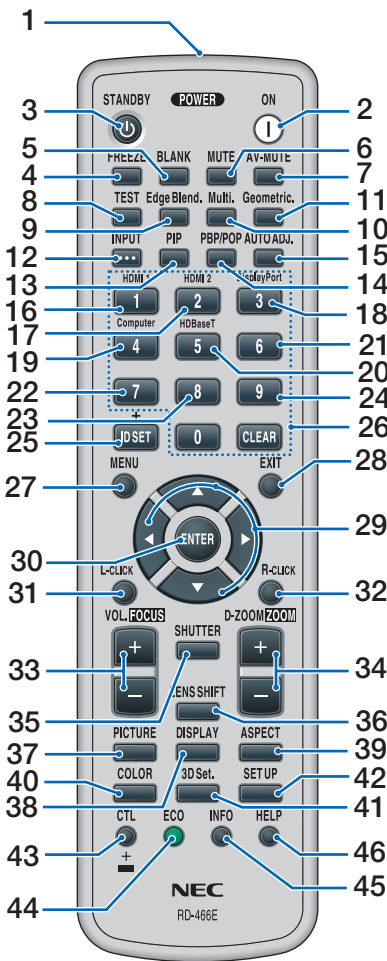

1. Infrared Transmitter

(→ page 12)

2. POWER ON Button

(→ page 16)

3. STANDBY Button

(→ page 28)

4. FREEZE Button

(→ page 32)

5. BLANK Button

(→ page 30)

6. MUTE Button

(→ page 30)

7. AV-MUTE Button

(→ page 30)

8. TEST Button

(→ page 85)

9. Edge Blend. Button

(→ page 69)

10. Multi. Button

(→ page 107)

11. Geometric. Button

(→ page 36, 101)

12. INPUT Button

(→ page 18)

13. PIP Button

(→ page 64)

14. PBP/POP Button

(→ page 64)

15. AUTO ADJ. Button

(→ page 27)

16. 1 (HDMI 1) Button

(→ page 18)

17. 2 (HDMI 2) Button

(→ page 18)

18. 3 (DisplayPort) Button

(→ page 18)

19. 4 (Computer) Button

(→ page 18)

20. 5 (HDBaseT) Button

(→ page 18)

21. 6 Button

(not available on this series of projectors)

22. 7 Button

(not available on this series of projectors)

23. 8 Button

(not available on this series of projectors)

24. 9 Button

(not available on this series of projectors)

25. ID SET Button

(→ page 121)

26. Numeric Keypad Button/

CLEAR Button

(→ page 121)

27. MENU Button

(→ page 74)

28. EXIT Button

(→ page 74)

29. ▲▼◀▶ Button

(→ page 74)

30. ENTER Button

(→ page 74)

31. L-CLICK Button*

32. R-CLICK Button*

33. VOL./FOCUS (+)(-) Button

(→ page 23, 27)

34. D-ZOOM/ZOOM (+)(-) Button

(→ page 25, 32)

35. SHUTTER Button

(→ page 30)

36. LENS SHIFT Button

(→ page 21)

37. PICTURE Button

(→ page 86)

38. DISPLAY Button

(→ page 99)

39. ASPECT Button

(→ page 92)

40. COLOR Button

(→ page 88)

41. 3D Set. Button

(→ page 44)

42. SETUP Button

(→ page 109)

43. CTL Button

(→ page 23, 24, 25)

44. ECO Button

(→ page 33)

45. INFO Button

(→ page 134)

46. HELP Button

(→ page 133)

* The ▲▼◀▶, L-CLICK and R-CLICK buttons work only when a USB cable is connected with your computer.

Battery Installation

1. Press the catch and remove the battery cover.
2. Install new ones (AA). Ensure that you have the batteries' polarity (+/-) aligned correctly.
3. Slip the cover back over the batteries until it snaps into place.

NOTE: Do not mix different types of batteries or new and old batteries.

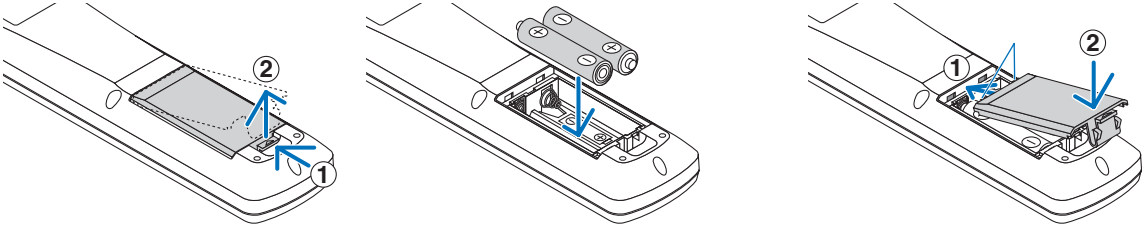

Remote Control Precautions

- Handle the remote control carefully.
- If the remote control gets wet, wipe it dry immediately.
- Avoid excessive heat and humidity.
- Do not short, heat, or take apart batteries.
- Do not throw batteries into fire.
- If you will not be using the remote control for a long time, remove the batteries.
- Ensure that you have the batteries' polarity (+/-) aligned correctly.
- Do not use new and old batteries together, or use different types of batteries together.
- Dispose of used batteries according to your local regulations.
- Replace two batteries at the same time with the quite same ones that has been installed in the remote control or AA sized alkalis battery that is conformed to IEC 60086-5.

Operating Range for Wireless Remote Control

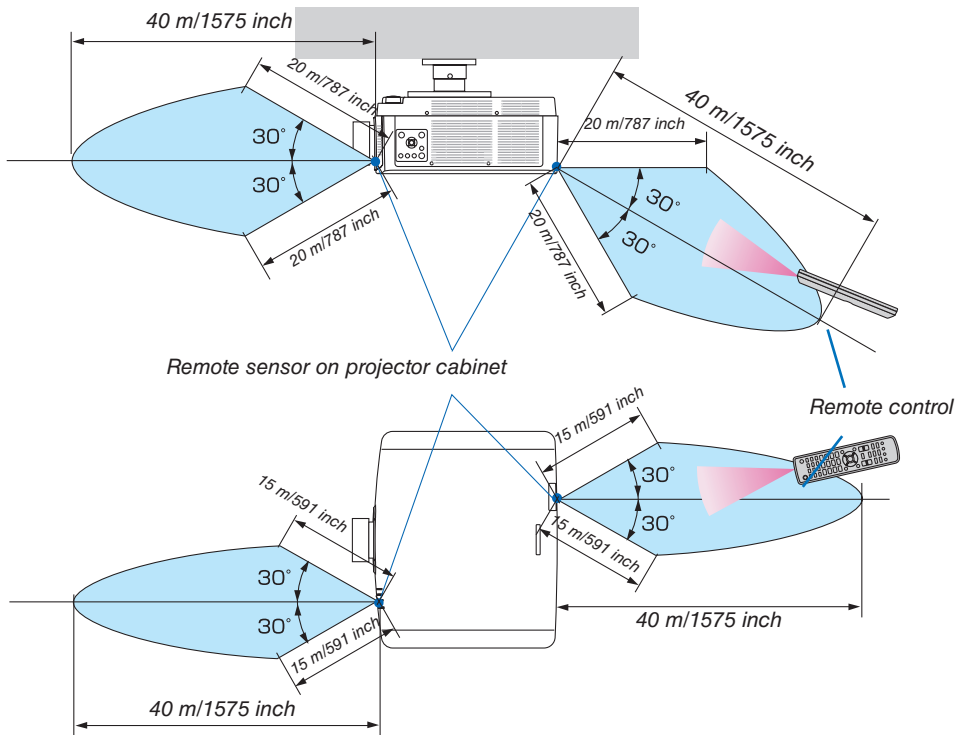

- The infrared signal operates by line-of-sight up to a distance of above meters and within a 60-degree angle of the remote sensor on the projector cabinet.
- The projector will not respond if there are objects between the remote control and the sensor, or if strong light falls on the sensor. Weak batteries will also prevent the remote control from properly operating the projector.

2. Projecting an Image (Basic Operation)

This section describes how to turn on the projector and to project a picture onto the screen.

① Flow of Projecting an Image

Step 1

- *Connecting your computer / Connecting the power cord (→ page 14)*



Step 2

- *Turning on the projector (→ page 16)*



Step 3

- *Selecting a source (→ page 18)*



Step 4

- *Adjusting the picture size and position (→ page 20)*
- *Correcting keystone distortion [CORNERSTONE] (→ page 36, 101)*



Step 5

- *Adjusting a picture and sound*
 - *Optimizing a computer signal automatically (→ page 27)*
 - *Turning up or down volume (→ page 27)*



Step 6

- *Making a presentation*



Step 7

- *Turning off the projector (→ page 28)*



Step 8

- *After use (→ page 29)*

② Connecting Your Computer/Connecting the Power Cord

1. Connect your computer to the projector.

This section will show you a basic connection to a computer. For information about other connections, see “6-2 Making Connections” on page 141.

Connect the display output terminal (mini D-sub 15 pin) on the computer to the computer video input terminal on the projector with a commercially-available computer cable (with ferrite core) and then turn the knobs of the connectors to secure them.

2. Connect the supplied power cord to the projector.

First connect the supplied power cord's three-pin plug to the AC IN terminal of the projector, and then connect another plug of the supplied power cord directly in the wall outlet. Do not use any plug converter.

CAUTION

- To prevent the power cord from coming loose, make sure that all the prongs of the power cord plug are fully inserted into the AC IN terminal of the projector before using the power cord stopper. A loose contact of the power cord may cause a fire or electric shock.

Upon connecting the power cable, the POWER indicator of the projector will light in green. If there are no input signals, the device will go into the standby state.

(In the state, standby mode is NORMAL.) (→ page 130)

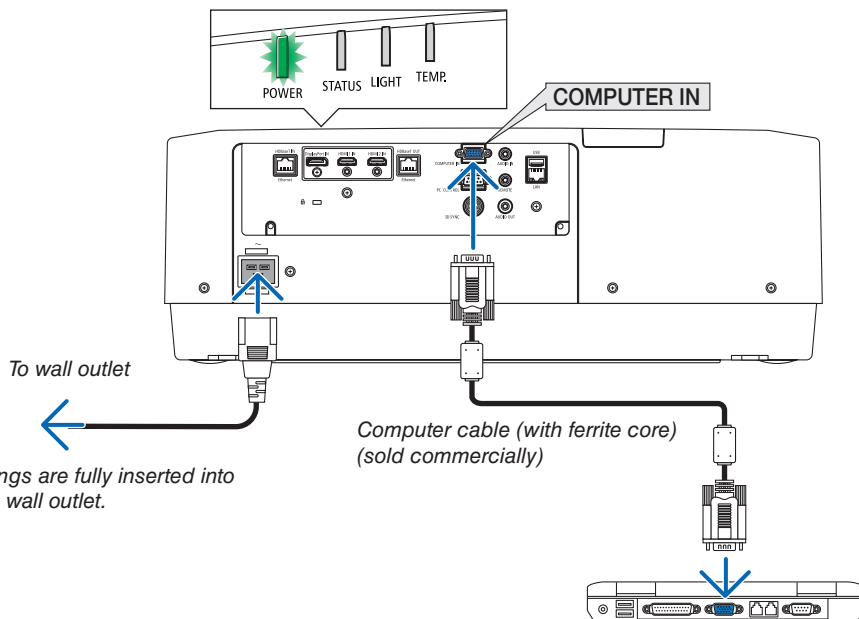

Make sure that the prongs are fully inserted into both the AC IN and the wall outlet.

2. Projecting an Image (Basic Operation)

CAUTION:

Parts of the projector may become temporarily heated if the projector is turned off with the POWER button or if the AC power supply is disconnected during normal projector operation.
Use caution when picking up the projector.

Using the power cord stopper

To prevent the power cord from accidentally removing from the AC IN of the projector, use the power cord stopper.

Required tool: Phillips screwdriver

1. **Mount the power cord stopper over the power plug that connected to the AC IN terminal.**

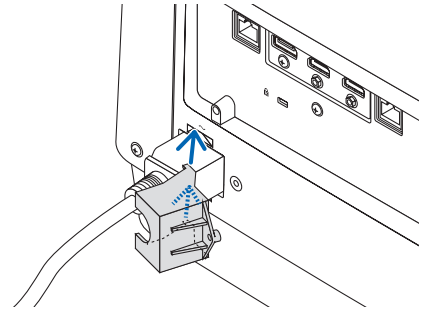

2. **Fasten the screw on the power cord stopper.**

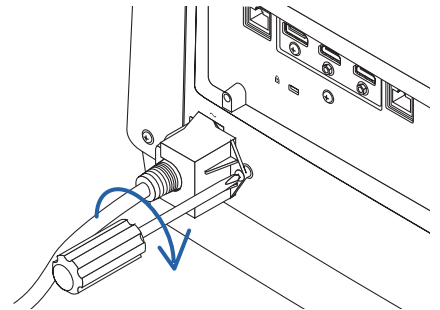

3 Turning on the Projector

1. Remove the lens cap.

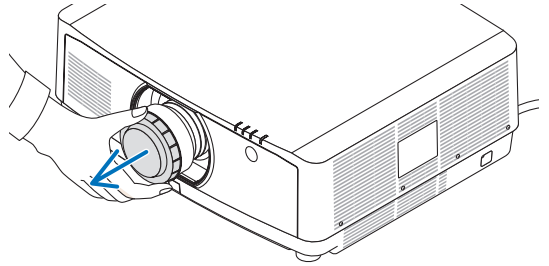

2. Press the  (POWER) button on the projector cabinet or the POWER ON button on the remote control.

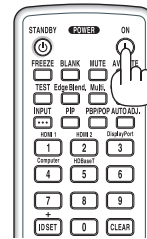

WARNING

The projector produces a strong light. When turning on the power, make sure no one within projection range is looking at the lens.

The POWER indicator lit in green will start to blink in blue. After that, the image will be projected onto the screen.

TIP:

- When the message "PROJECTOR IS LOCKED! ENTER YOUR PASSWORD." is displayed, it means that the [SECURITY] feature is turned on. (→ page 41)

After you turn on your projector, ensure that the computer or video source is turned on.

NOTE: A blue screen (blue background) is displayed when no signal is being input (by factory default menu settings).

Sleep state

Blinking

Power On

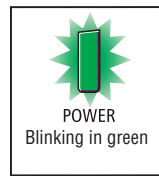

(→ page 165)

Performing Lens Calibration

After mounting the separately available lens unit or replacing a lens unit, perform [LENS CALIBRATION] by holding to press ZOOM/L-CALIB. button on the cabinet over two seconds.

Calibration corrects the adjustable zoom, shift, and focus range. If calibration is not performed, you may not be able to get the best focus and zoom even if you adjust the focus and zoom for the lens.

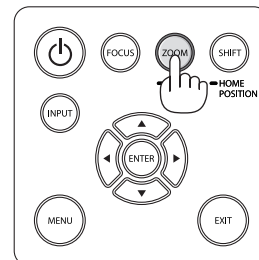

2. Projecting an Image (Basic Operation)

Note on Startup screen (Menu Language Select screen)

When you first turn on the projector, you will get the Startup menu. This menu gives you the opportunity to select one of the 30 menu languages.

To select a menu language, follow these steps:

1. Use the ▲, ▼, ◀ or ▶ button to select one of the 30 languages from the menu.

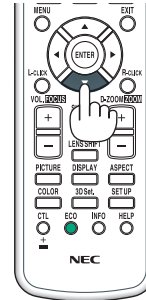

2. Press the ENTER button to execute the selection.

After this has been done, you can proceed to the menu operation.

If you want, you can select the menu language later.

(→ [LANGUAGE] on page 78 and 109)

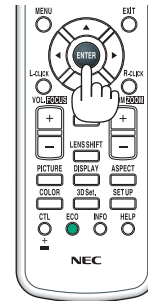

NOTE:

- If the message, [PLEASE SET "DATE AND TIME".] is shown, please set the current date and time. (→ page 120)
- In the case this message is not shown, the [DATE AND TIME SETTING] is recommended to complete.
- Keep the lens cap off the lens while the projector's power is on.
If the lens cap is on, it could be warped due to high temperature.
- If the STATUS indicator lights orange with the power button pressed, the projector will not be turned on since the [CONTROL PANEL LOCK] has been ON. Cancel the lock by turning it off. (→ page 120)
- While the POWER indicator is blinking blue in short cycles, the power cannot be turned off by using the power button.

4 Selecting a Source

Selecting the computer or video source

NOTE: Turn on the computer or video source equipment connected to the projector.

Detecting the Signal Automatically

Press the INPUT button for 1 second or longer. The projector will search for the available input source and display it. The input source will change as follows:

HDMI1 → HDMI2 → DisplayPort → COMUPTER → HDBaseT → HDMI1 → ...

- Press it briefly to display the [INPUT] screen.

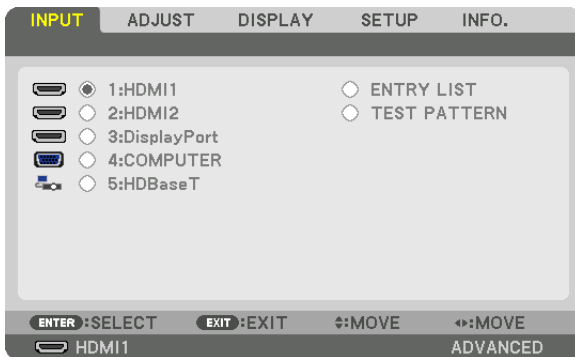
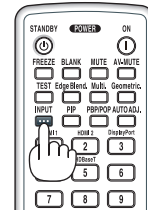

Press the ▼/▲ buttons to match the target input terminal and then press the ENTER button to switch the input. To delete the menu display in the [INPUT] screen, press the MENU or EXIT button.

TIP: If no input signal is present, the input will be skipped.

Using the Remote Control

Press any one of the 1/HDMI 1, 2/HDMI 2, 3/DisplayPort, 4/Computer, or 5/HDBaseT button.



Selecting Default Source

You can set a source as the default source so that it will be displayed each time the projector is turned on.

1. Press the MENU button.

The menu will be displayed.

2. Press the ► button to select [SETUP] and press the ▼ button or the ENTER button to select [BASIC].

3. Press the ► button to select [SOURCE OPTIONS] and press the ▼ button or the ENTER button.

4. Press the ▼ button three times to select [DEFAULT INPUT SELECT] and press the ENTER button.

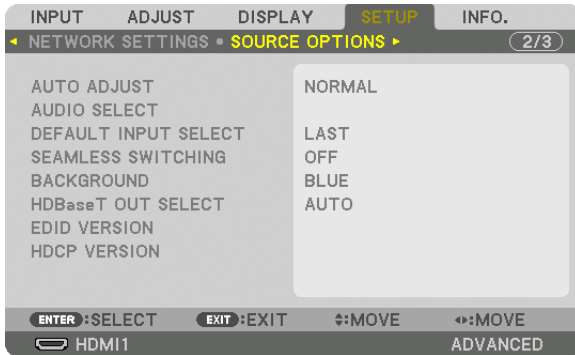

The [DEFAULT INPUT SELECT] screen will be displayed.

(→ page 128)

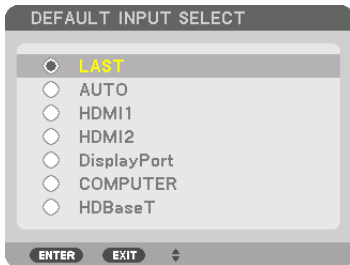

5. Select a source as the default source, and press the ENTER button.

6. Press the EXIT button a few times to close the menu.

7. Restart the projector.

The source you selected in step 5 will be projected.

NOTE: Even when [AUTO] is turned on, the [HDBaseT] will not be automatically selected. To set your network as the default source, select [HDBaseT].

TIP:

- When the projector is in Standby mode, applying a computer signal from a computer connected to the COMPUTER IN input will power on the projector and simultaneously project the computer's image.
([AUTO POWER ON SELECT] → page 130)
- On the Windows 7 keyboard, a combination of the Windows and P keys allows you to set up external display easily and quickly.

5 Adjusting the Picture Size and Position

Use the lens shift dial, the adjustable tilt foot lever, the zoom and the focus ring to adjust the picture size and position.
In this chapter drawings and cables are omitted for clarity.

Adjusting the projected image's vertical and horizontal position
[Lens shift]
(→ page 21)

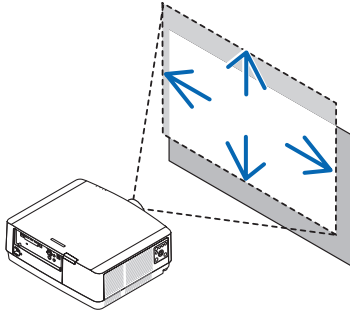

Adjusting the focus
[Focus]
(→ page 22)

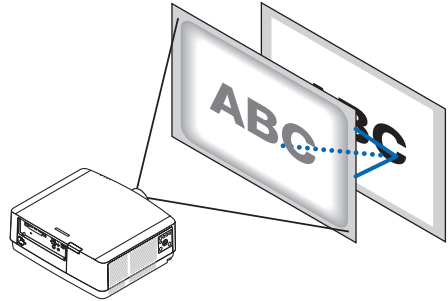

Finely adjusting the size of an image
[Zoom]
(→ page 25)

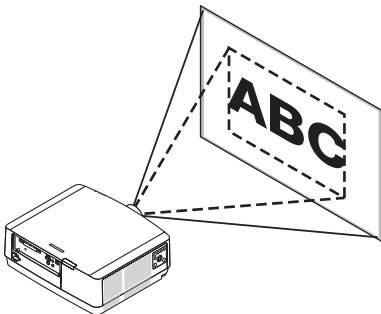

Adjusting the projected image's inclination
[Tilt foot]
(→ page 26)

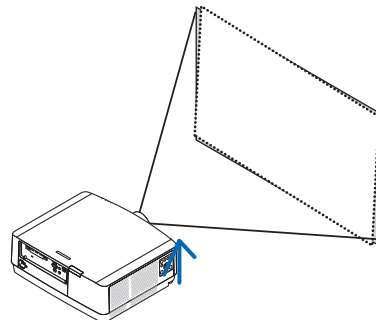

2. Projecting an Image (Basic Operation)

Adjusting the vertical position of a projected image (Lens shift)

CAUTION

- Perform the adjustment from behind or from the side of the projector. Adjusting from the front could expose your eyes to strong light which could injure them.
- Keep hands away from the lens mounting portion while performing a lens shift. Failure to do so could result in fingers being pinched by the moving lens.

1. Press either **SHIFT/HOME POSITION** button on the cabinet or **LENS SHIFT** button on the remote control.

The [LENS SHIFT] screen will be displayed.

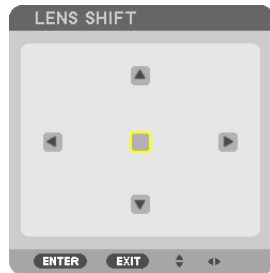

2. Press the **▼▲◀▶** buttons to move the projected image.

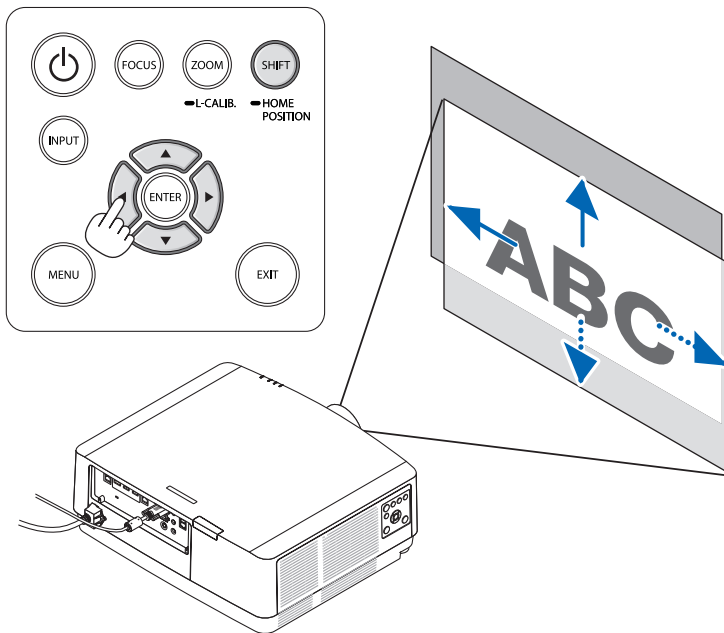

- To set back the lens to the home position

Press and hold the **SHIFT/HOME POSITION** button over 2 seconds. The lens mounted on the projector goes back to the home position. (roughly to the center position)

NOTE:

- If the lens is shifted to the maximum in the diagonal direction, the screen peripheral area will be dark or shaded.

2. Projecting an Image (Basic Operation)

TIP:

- The diagram below shows the lens shift adjustment range (orientation: desk/front).

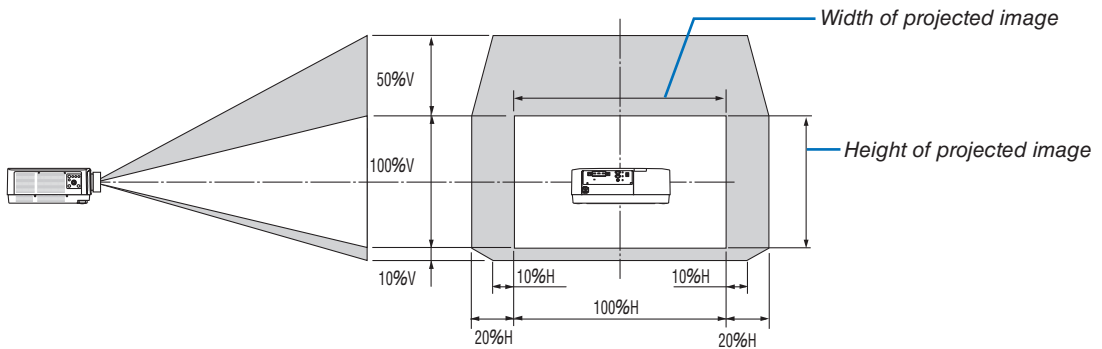

Description of symbols: *V* indicates vertical (height of the projected image), *H* indicates horizontal (width of the projected image).

Focus

Recommend to perform the focus adjustment after leaving the projector under the state the TEST PATTERN has been projected for over 30 minutes.

Please refer to page [85](#) in the User's Manual about the TEST PATTERN.

2. Projecting an Image (Basic Operation)

Applicable lens: NP40ZL/NP41ZL

1. Press the FOCUS button on the cabinet.

The LENS FOCUS control screen will be displayed on.



* Press ◀▶ buttons to adjust focus. In another way, press and hold the CTL button and then press VOL./FOCUS +/- button on the remote control

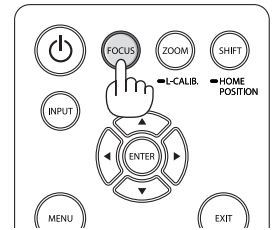
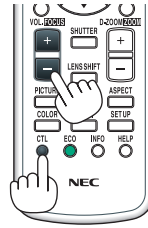

2. When the cursor is on the CENTER on on-screen menu, press either ◀ or ▶ button to align focus around the optical axis.

* The picture shows an example when the lens shift is moved upward. The focus for the lower part of the screen is aligned.

When the lens is at the center, the focus for the center of the screen is aligned.

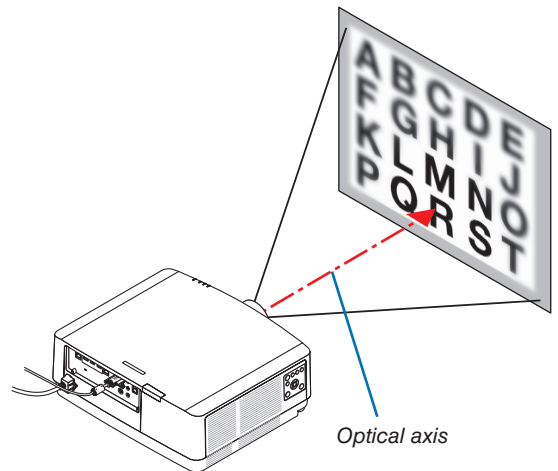
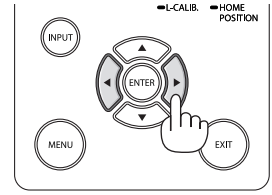
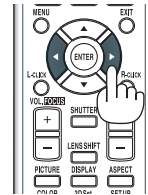

3. Press ▼ button to select the PERIPHERY on the on-screen menu, and then press either ◀ or ▶ button to align the focus of screen peripheral area. During this operation, the focus for around the optical axis will be maintained.

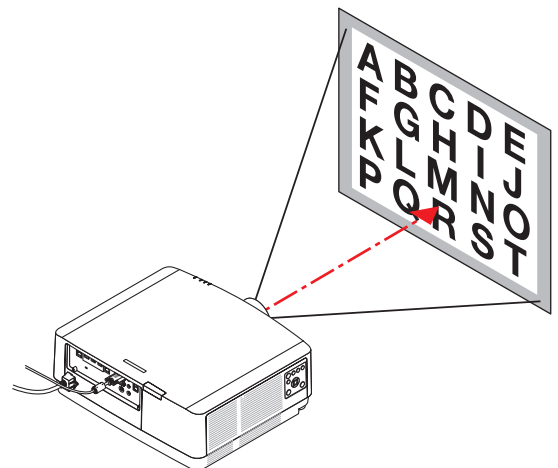

2. Projecting an Image (Basic Operation)

Applicable lens: NP42ZL

1. Press the FOCUS button on the cabinet.



Press ◀▶ buttons to adjust focus. In another way, press and hold the CTL button and then press VOL./FOCUS +/- button on the remote control.

* PERIPHERY LENS FOCUS is not available for this lens unit.

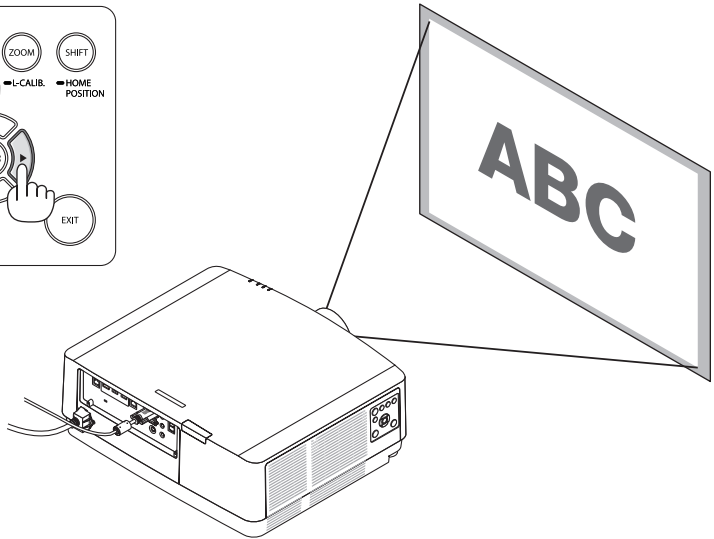
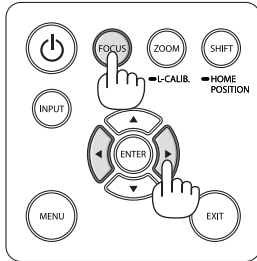
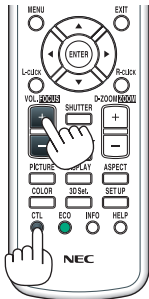

Zoom

1. Press ZOOM/L-CALIB. button.

The ZOOM adjustment screen will be displayed on.



- ◀ or ▶ buttons on the cabinet or the remote control are available to adjust ZOOM while the ZOOM adjustment screen is displayed on.
 - On the remote control, while pressing on the CTL button, press the D-ZOOM/ZOOM (+) or (-) button.
- The zoom is adjusted.

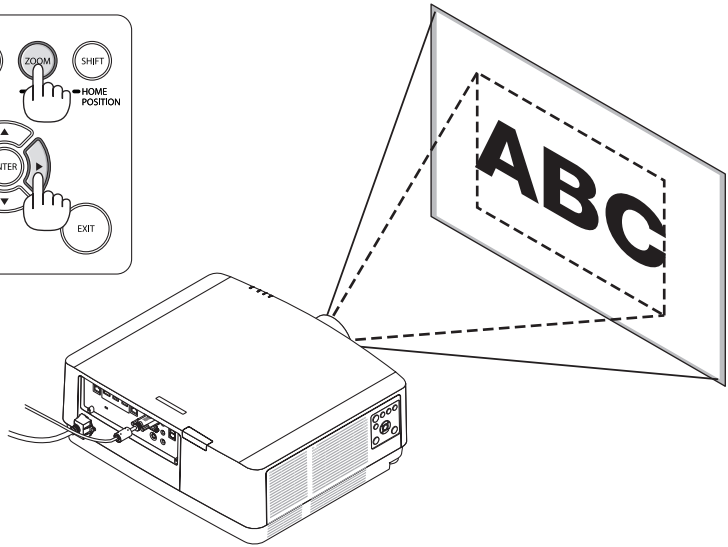
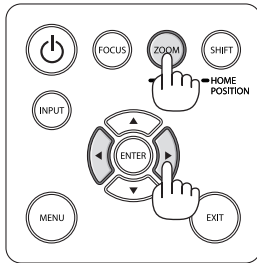
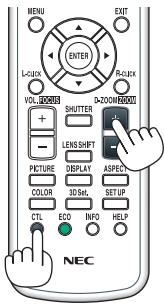

Adjusting the Tilt Foot

1. Turn the left and right tilt foot to adjust.

The tilt foot lengthen and shorten when turned.

Turn one of the tilt foot to adjust the image so that it is level.

- If the projected image is distorted, see “3-7 Correcting Horizontal and Vertical Keystone Distortion [CORNERSTONE]” (→ page 36) and “[GEOMETRIC CORRECTION]” (→ page 101).
- The tilt foot can be lengthened by a maximum of 10 mm/0.4".
- The tilt foot can be used to tilt the projector by a maximum of 1.4°.

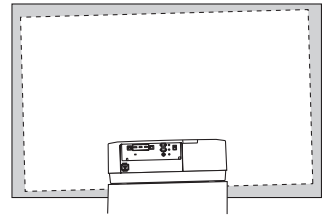

NOTE:

- Do not lengthen the tilt foot any more than 10 mm/0.4". Doing so will make the projector unstable.
- Do not use the tilt foot for any purpose other than adjusting inclination of the projector installation angle.

Handling the tilt foot improperly, such as carrying the projector by grasping the tilt foot or hooking it onto a wall using the tilt foot, could damage the projector.

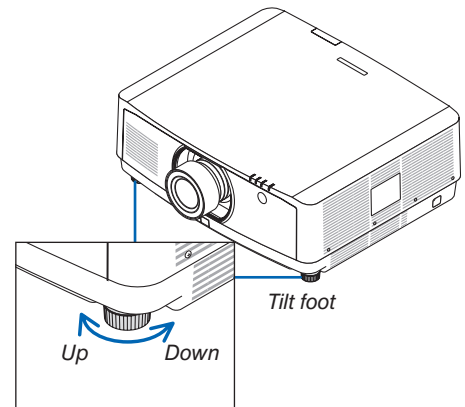

6 Optimizing Computer Signal Automatically

Adjusting the Image Using Auto Adjust

When projecting a signal from the computer video input terminal, HDMI 1 IN terminal, HDMI 2 IN terminal, DisplayPort IN terminal, HDBaseT IN/Ethernet port, adjust the picture quality with a single touch of the button if the edges of the screen are cut off or if the projection quality is bad.

Press the AUTO ADJ. button to optimize a computer image automatically.

This adjustment may be necessary when you connect your computer for the first time.

[Poor picture]

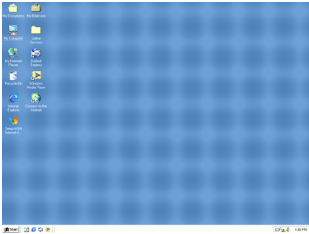

[Normal picture]

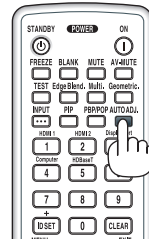
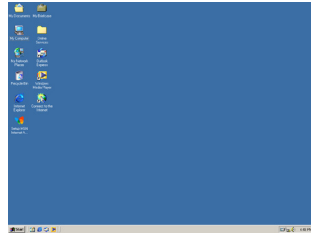

NOTE:

Some signals may take time to display or may not be displayed correctly.

- If the Auto Adjust operation cannot optimize the computer signal, try to adjust [HORIZONTAL], [VERTICAL], [CLOCK], and [PHASE] manually. (→ page 90, 91)

7 Turning Up or Down Volume

Sound level from the AUDIO OUT terminal can be adjusted.

Important:

- Do not turn up the volume to the maximum level on the external speaker system connected to the AUDIO OUT of the projector. Doing so may produce an unexpected, loud sound at the time of turning on or off the projector, causing damage to your hearing. When adjusting the volume on the external speaker system, set volume level of the speaker system to less than half its rating and adjust the volume on the projector to get appropriate sound level.

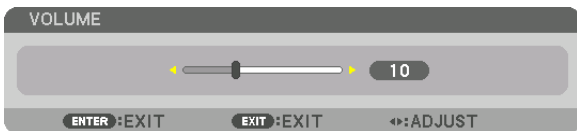

TIP: When no menus appear, the ◀ and ▶ buttons on the projector cabinet work as a volume control.

NOTE:

- Volume control is not available with the ◀ or ▶ button when an image is enlarged by using the D-ZOOM (+) button or when the menu is displayed.

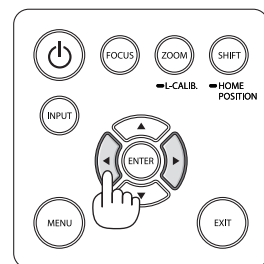
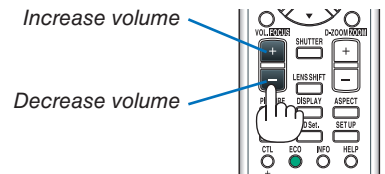

8 Turning off the Projector

To turn off the projector:

1. First, press the  (POWER) button on the projector cabinet or the STANDBY button on the remote control.

The [POWER OFF / ARE YOU SURE ? / CARBON SAVINGS- SESSION 0.000[g-CO2]] message will appear.

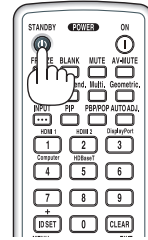
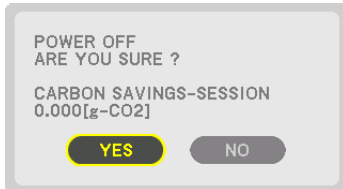

2. Secondly, press the ENTER button or press the  (POWER) or the STANDBY button again.

The light source will be turned off and the power supply will be cut. The projector will go to sleep state and the POWER indicator will light in green. If no operation is performed on the projector and no signal is input to the projector, the projector will be in standby state. The POWER indicator will blink in orange (In the state, the standby mode is NORMAL.).

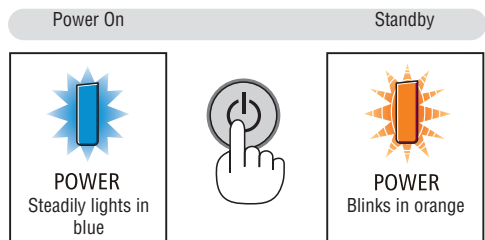

CAUTION:

Parts of the projector may become temporarily heated if the projector is turned off with the POWER button or if the AC power supply is disconnected during normal projector operation. Use caution when picking up the projector.

NOTE:

- While the POWER indicator is blinking blue in short cycles, the power cannot be turned off.
- You cannot turn off the power for 60 seconds immediately after turning it on and displaying an image.
- Do not unplug the power cord from the projector or from the power outlet while an image is being projected. Doing so could deteriorate the projector's AC IN terminal or the power plug's contact. To turn off the AC power while an image is being projected, use the power strip's switch, the breaker, etc.
- Do not disconnect the AC power supply to the projector within 10 seconds of making adjustment or setting changes and closing the menu. Doing so can cause loss of adjustments and settings.

9 After Use

Preparation: Make sure that the projector is turned off.

1. *Unplug the power cord.*

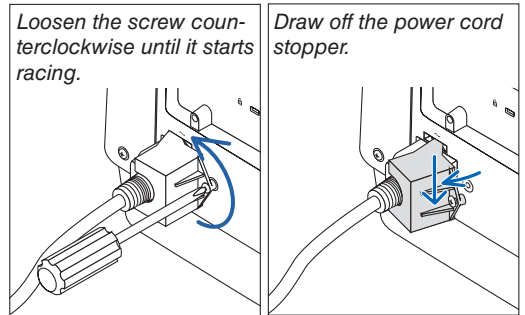

2. *Disconnect any other cables.*

3. *Mount the lens cap on the lens.*

4. *Before moving the projector, screw in the tilt foot if they have been lengthened.*

3. Convenient Features

1 Turn off the light of the projector (LENS SHUTTER)

Press the SHUTTER button on the remote control.

The light source will turn off temporarily.

Press again to allow the screen to become illuminated again.

- You can set the projection light to gradually fade in or out.

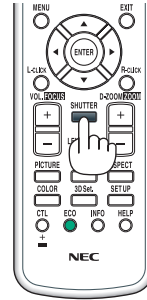

2 Turning off the Image and Sound

The projected video and the output sound from the sound output terminal will disappear momentarily.

Press the BLANK button.

The projected video will be cut off.

Press the MUTE button.

The audio will be cut off.

Press the AV-MUTE button.

The projected video and audio will be cut off.

- Press the buttons one more time for the cancelled video and audio to appear again.

TIP:

- The video will disappear but not the menu display.

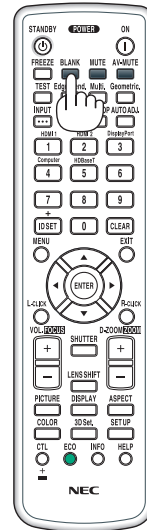

③ Shift the On-Screen Menu displaying position

1. Press the **MENU** button.

The On-Screen Menu will be displayed on.

2. Move the cursor by the **▶** button to the **[SETUP]** and then press the **ENTER** button.

The cursor will move to the **[MENU(1)]**.

3. Move the cursor by the **▶** button to the **[MENU(2)]**.

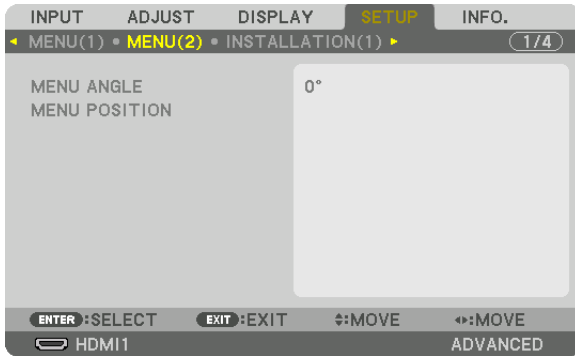

4. Move the cursor by the **▼** button to the **[MENU POSITION]** and then press the **ENTER**.

The On-Screen Menu will go into the **MENU POSITION** setup screen.

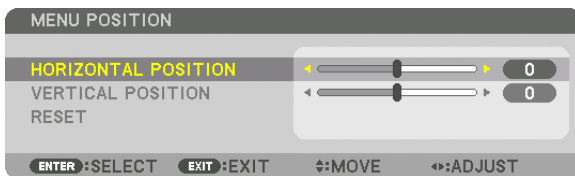

5. Move the cursor either to **[HORIZONTAL POSITION]** or **[VERTICAL POSITION]** by pressing **▼** or **▲** button and then press **◀/▶** button to shift the On-Screen Menu.

For finishing the setting on the On-Screen Menu, press the **MENU** button on the remote control.

TIP:

- Once the projector is powered off, the On-Screen Menu displaying position will be reset to the default factory setting position.
- This function does not influence to the display position of input terminal information and message.
- It enables to move the menu by mouse click when a commercially available USB mouse is connected.
- It enables to move the menu position by the **▼▲◀** and **▶** buttons holding to press the **CTL** button on the remote control or mouse click.
- While the **MENU POSITION** of the on-screen menu is displayed on and the menu is moved by the **▼▲◀** and **▶** buttons holding to press the **CTL** button on the remote control, the indication of adjusted value on the menu will not be changed. In this case, close the **MENU POSITION** menu once and display it again for indicating the adjusted value properly.

4 Freezing a Picture

Press the FREEZE button to freeze a picture. Press again to resume motion.

NOTE: The image is frozen but the original video is still playing back.

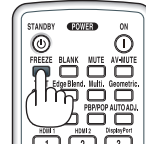

5 Enlarging a Picture

You can enlarge the picture up to four times.

NOTE:

- Depending on an input signal, the maximum magnification may be less than four times, or the function may be restricted.

To do so:

1. Press the D-ZOOM (+) button to magnify the picture.

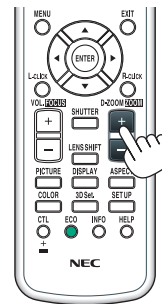
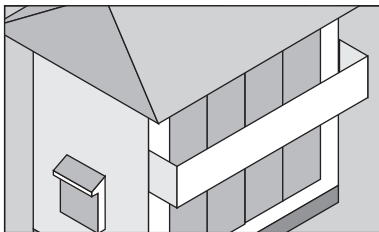
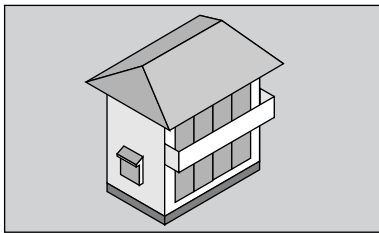

2. Press the ▲▼◀▶ button.

The area of the magnified image will be moved

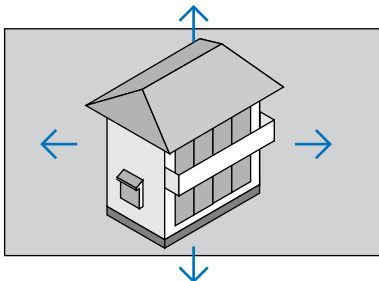

3. Press the D-ZOOM (-) button.

Each time the D-ZOOM (-) button is pressed, the image is reduced.

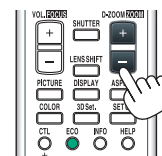

NOTE:

- The image will be enlarged or reduced at the center of the screen.
- Displaying the menu will cancel the current magnification.



⑥ Changing LIGHT MODE/Checking Energy-Saving Effect Using LIGHT MODE [LIGHT MODE]

When either [ECO1] or [ECO2] in [LIGHT MODE] is selected, motion noise of the projector is cut down by lowering brightness of its light source.

LIGHT MODE	Icon at the bottom of the menu	Description
NORMAL		100% brightness The screen will be brightly lit. Depending on the installation circumstances, the service life of optical parts may be shorten.
ECO1		Brightness will be at about 80%. The cooling fan will also slow down accordingly. Lower power consumption
ECO2		Brightness will be at about 60%. The cooling fan will also slow down accordingly. Lower power consumption considerably More eco-friendly setting than NORMAL and ECO1.
LONG LIFE		Brightness is about 30%. This setting speeds up the cooling fan and optimizes the service life of the optical parts. The most eco-friendly setting among the options.

To turn on the [LIGHT MODE], do the following:

1. Press ECO button on the remote control.

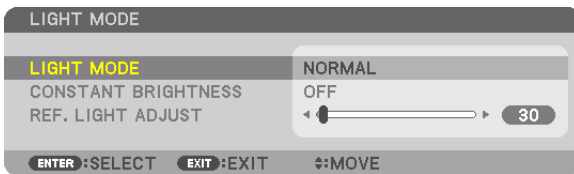
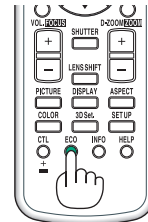

The [LIGHT MODE] screen will be displayed.

2. Press the ENTER button.

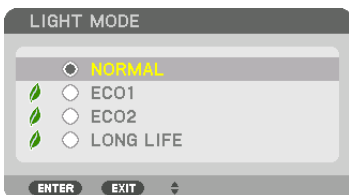

The [LIGHT MODE] selection screen will be displayed.

3. Use the ▼▲ buttons to make a selection, and press the ENTER button.

The display will return to the [LIGHT MODE] screen and the selected option will be applied.

Press the EXIT button to return to the original screen.

NOTE:

- The [LIGHT MODE] can be changed by using the menu.
Select [SETUP] → [INSTALLATION(1)] → [LIGHT MODE] → [LIGHT MODE].
 - The light module used hours can be checked in [USAGE TIME]. Select [INFO.] → [USAGE TIME].
 - After a lapse of 1 minute from when the projector displays a blue, black or logo screen, the projector will automatically lower the brightness to the equivalent level of [ECO2] when [NORMAL] or [ECO1] has been selected for [LIGHT MODE] and it will be automatically back to the previous brightness when it detects input signal.
 - If the projector is overheated in [NORMAL] or [ECO1] mode, there may be a case the projector automatically lowers the brightness as a protective function. This is called "Forced ECO MODE". When the projector is in the Forced ECO MODE, the picture brightness decreases slightly and the TEMP. indicator lights orange. At the same time the Thermometer symbol [] is displayed at the bottom right of the screen.
When the ambient temperature is lowered under approx 33°, the Forced ECO MODE is cancelled and the projector goes back into the previously set state.
-

Checking Energy-Saving Effect [CARBON METER]

This feature will show energy-saving effect in terms of CO₂ emission reduction (kg) when the projector's [LIGHT MODE] is set to either [ECO1], [ECO2], or [LONG LIFE]. This feature is called as [CARBON METER].

There are two messages: [TOTAL CARBON SAVINGS] and [CARBON SAVINGS-SESSION]. The [TOTAL CARBON SAVINGS] message shows the total amount of CO₂ emission reduction from the time of shipment up to now. You can check the information on [USAGE TIME] from [INFO.] of the menu. (→ page 133)

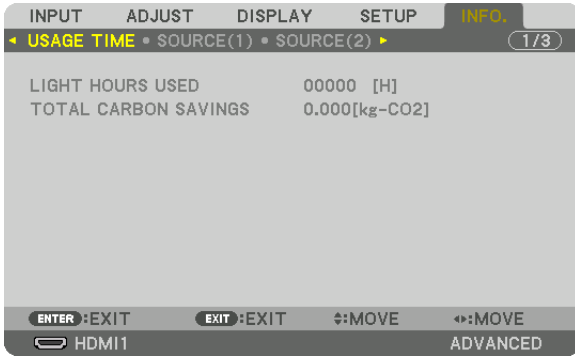

The [CARBON SAVINGS-SESSION] message shows the amount of CO₂ emission reduction between the time of changing to LIGHT MODE immediately after the time of power-on and the time of power-off. The [CARBON SAVINGS-SESSION] message will be displayed in the [POWER OFF/ ARE YOU SURE ?] message at the time of power-off.

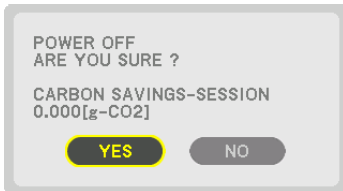

TIP:

- The formula shown below is used to calculate the amount of CO₂ emission reduction. Amount of CO₂ emission reduction = (Power consumption in [NORMAL] LIGHT MODE – Power consumption in current setting) × CO₂ conversion factor. * Setting the [LIGHT MODE] to [ECO1], [ECO2], or [LONG LIFE] increases CO₂ emissions savings.
* Calculation for amount of CO₂ emission reduction is based on an OECD publication “CO₂ Emissions from Fuel Combustion, 2008 Edition”.
- The [TOTAL CARBON SAVINGS] is calculated based on savings recorded in 15 minutes intervals.
- This formula will not apply to the power consumption which is not affected by whether [LIGHT MODE] is turned on or off.

7 Correcting Horizontal and Vertical Keystone Distortion [CORNERSTONE]

Use the [CORNERSTONE] feature to correct keystone (trapezoidal) distortion to make the top or bottom and the left or right side of the screen longer or shorter so that the projected image is rectangular.

1. Project an image so that the screen is smaller than the area of the raster.

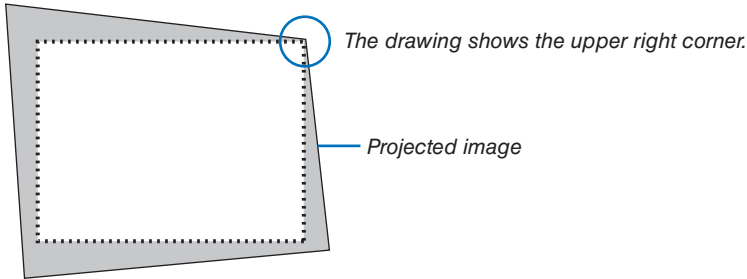

2. Pick up any one of the corners and align the corner of the image with a corner of the screen.

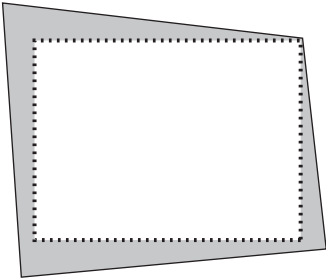

3. Press the **Geometric** button either on the cabinet or the remote control.

Display the [GEOMETRIC CORRECTION] screen of the on-screen menu.

4. Move the cursor onto [MODE] by ▼ button and press the **ENTER**.

The mode selection screen will displayed on.

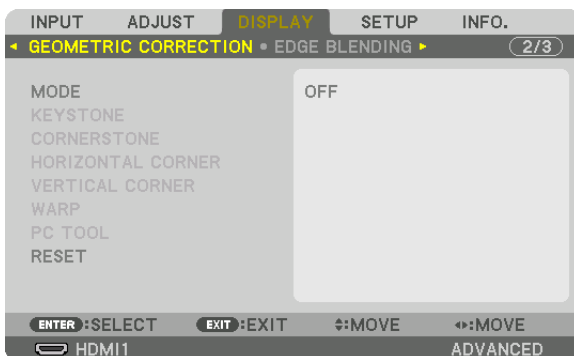

5. Select [CORNERSTONE] and press the **ENTER**.

Go back to display the [GEOMETRIC CORRECTION] screen of the on-screen menu.

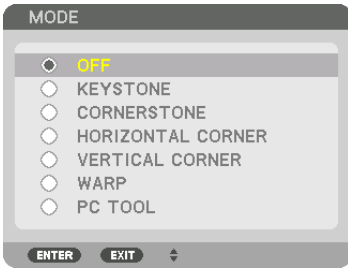

6. Press the ▼ button to align with the [CORNERSTONE] and then press the ENTER button.



The drawing shows the upper left icon (▼) is selected.

The screen will switch to the [CORNERSTONE] screen.

7. Use the ▲▼◀▶ button to select one icon (▲) which points in the direction you wish to move the projected image frame.
8. Press the ENTER button.
9. Use the ▲▼◀▶ button to move the projected image frame as shown on the example.

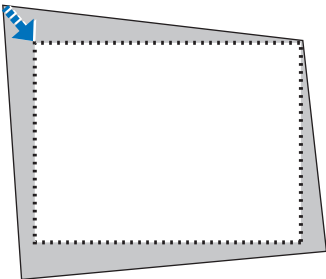

10. Press the ENTER button.

11. Use the ▲▼◀▶ button to select another icon which points in the direction.

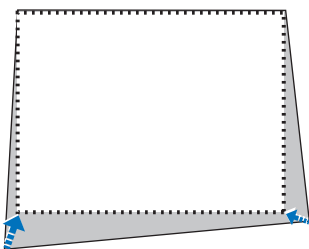

On the [CORNERSTONE] screen, select [EXIT] or press the EXIT button on the remote control.

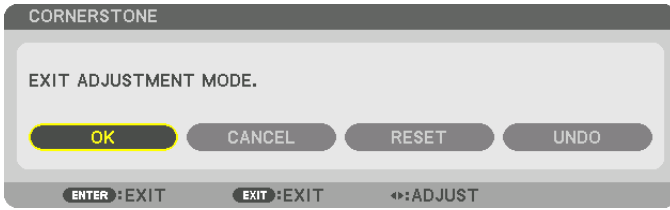

The confirmation screen is displayed.

12. Press the ◀ or ▶ button to highlight the [OK] and press the ENTER button.

This completes the [CORNERSTONE] correction.

- Select [CANCEL] and press the ENTER button to return to the [CORNERSTONE] screen.

Selecting [CANCEL] will return to the adjustment screen without saving changes (Step 3).

Selecting [RESET] will return to the factory default.

Selecting [UNDO] will exit without saving changes.

NOTE:

- Even when the projector is turned on, the last used correction values are applied.
- Carry out either one of the following actions to clear the adjustment value of [CORNERSTONE].
 - In Step 11, select [RESET] and then press the ENTER button.
 - In the state [CORNERSTONE] has been selected for [MODE] in the [GEOMETRIC CORRECTION]:
 - Press the Geometric. button for 2 or more seconds.
 - Run [DISPLAY] → [GEOMETRIC CORRECTION] → [RESET] in the on-screen menu.
- Using CORNERSTONE correction can cause the image to be slightly blurred because the correction is made electronically.
- A commercially available USB mouse is available for CORNERSTONE correction.

⑧ Operation for the On-Screen Menu by a commercially available USB mouse

Once a commercially available USB mouse is connected to this projector, it enables to perform the operation for the on-screen menu and the geometric correction easily.

NOTE:

- Not guarantee the performance of all USB mouse available on the market.

Menu operation

1. Display the on-screen menu by right click.
2. Select a desired menu and perform adjustment by left click.

The adjustment bar can be control by drag and drop.



3. Convenient Features

3. Select [EXIT] displayed at the bottom of the menu by left click for going back to the previous level. If the cursor is on the main menu option, it works for closing the menu. (It works as the same performance with the [EXIT] button on the remote control.)

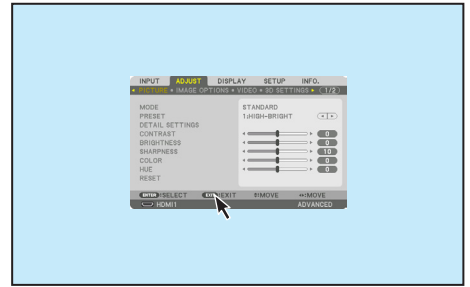

Menu position control

1. Click the wheel button to display the on-screen menu indication frame.
2. Left click at the position on the projection screen where you want to shift the on-screen menu. The nearest corner of the on-screen menu indication frame will shift to the clicked position.

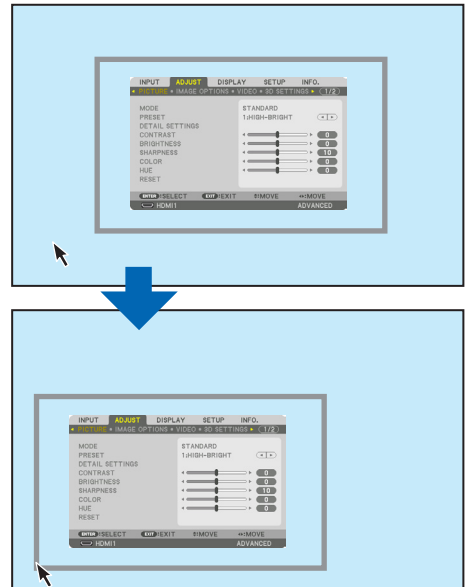

3. Click the wheel button to close the menu indication frame.

Geometric correction

The USB mouse can be used for CORNERSTONE CORRECTION, HORIZONTAL CORNER, VERTICAL CORNER and WARP. In this clause, the CORNERSTONE CORRECTION by an USB mouse is explained as an example.

1. While the adjustment screen of the CORNERSTONE CORRECTION is displayed, right click on the projection screen. The shape of mouse pointer will be changed and the correction will become available.

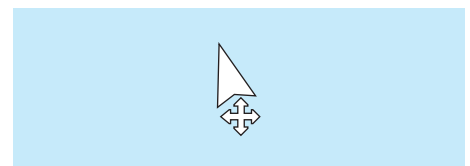

3. Convenient Features

2. Left click at the screen corner. The projection screen corner will move to the mouse clicked position.
3. Repeat the step 2 for correcting all distortion. After completion of distortion correction, right click on the projection screen. The shape of mouse pointer will be changed to normal.

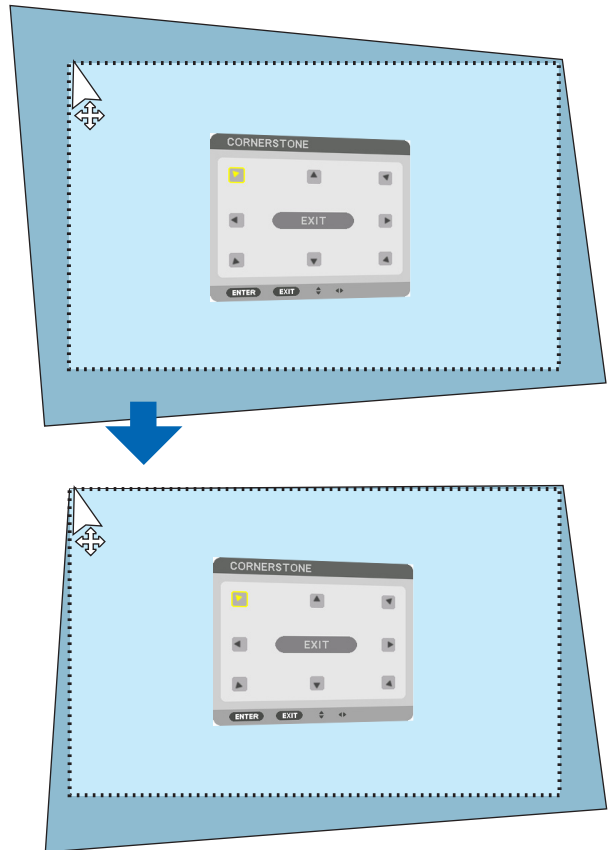

4. Left click [EXIT] on the correction screen to finish.

9 Preventing the Unauthorized Use of the Projector [SECURITY]

A keyword can be set for your projector using the Menu to avoid operation by an unauthorized user. When a keyword is set, turning on the projector will display the Keyword input screen. Unless the correct keyword is entered, the projector cannot project an image.

- The [SECURITY] setting cannot be cancelled by using the [RESET] of the menu.

To enable the Security function:

1. Press the MENU button.

The menu will be displayed.

2. Press the ► button twice to select [SETUP] and press the ▼ button or the ENTER button to select [MENU(1)].

3. Press the ► button to select [CONTROL].

4. Press the ▼ button three times to select [SECURITY] and press the ENTER button.

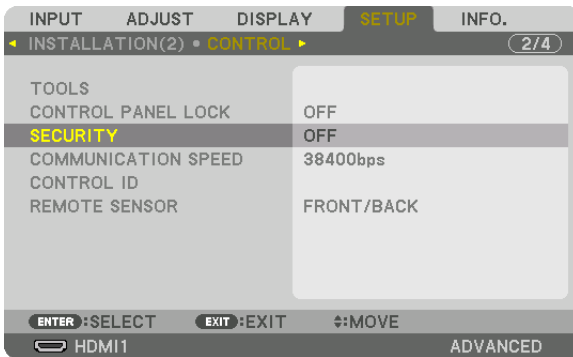

The OFF/ON menu will be displayed.

5. Press the ▼ button to select [ON] and press the ENTER button.

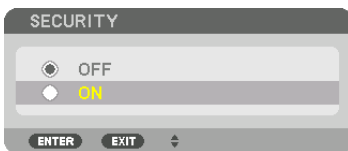

The [SECURITY KEYWORD] screen will be displayed.

6. Type in a combination of the four ▲▼◀▶ buttons and press the ENTER button.

NOTE: A keyword must be 4 to 10 digits in length.



The [CONFIRM KEYWORD] screen will be displayed.

NOTE: Make a note of your password and store it in a safe place.

7. Type in the same combination of ▲▼◀▶ buttons and press the ENTER button.

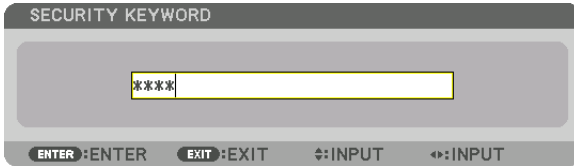

The confirmation screen will be displayed.

8. Select [YES] and press the ENTER button.



The SECURITY function has been enabled.

To turn on the projector when [SECURITY] is enabled:

1. Press the POWER button.

The projector will be turned on and display a message to the effect that the projector is locked.

2. Press the MENU button.

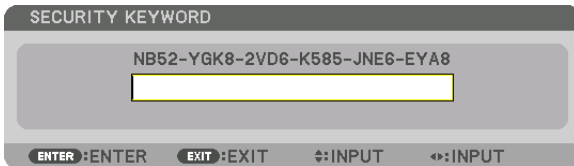

3. Type in the correct keyword and press the ENTER button. The projector will display an image.

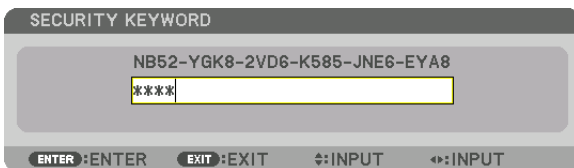

NOTE: The security disable mode is maintained until the main power is turned off or unplugging the power cord.

To disable the SECURITY function:

1. Press the MENU button.

The menu will be displayed.

2. Select [SETUP] → [CONTROL] → [SECURITY] and press the ENTER button.

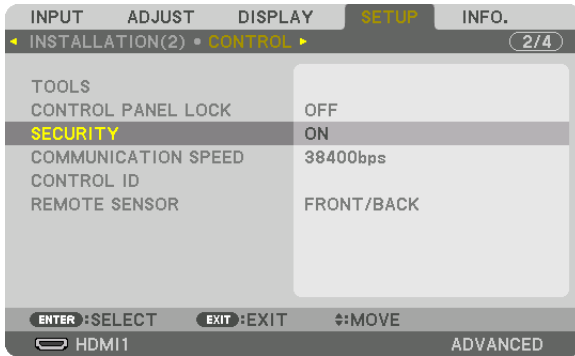

The OFF/ON menu will be displayed.

3. Select [OFF] and press the ENTER button.

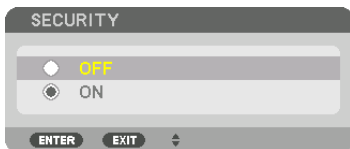

The SECURITY KEYWORD screen will be displayed.

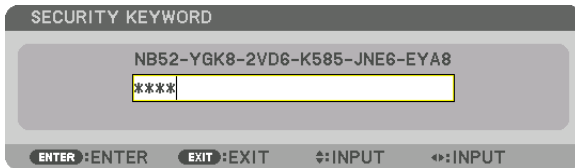

4. Type in your keyword and press the ENTER button.

When the correct keyword is entered, the SECURITY function will be disabled.

NOTE: If you forget your keyword, contact your dealer. Your dealer will provide you with your keyword in exchange for your request code. Your request code is displayed in the Keyword Confirmation screen. In this example [NB52-YGK8-2VD6-K585-JNE6-EYA8] is a request code.

10 Projecting 3D videos

This projector can be used to watch videos in 3D using commercially-available active shutter-type 3D eyewear. In order to synchronize the 3D video and eyewear, a commercially-available 3D emitter needs to be connected to the projector (on the projector side).

The 3D eyewear receives information from the 3D emitter and performs opening and closing on the left and right.

CAUTION

Health precautions

Before use, please make sure to read any health precautions that may be stated in the operating manuals enclosed with the 3D eyewear and 3D video software (Blu-ray player, games, computer animation files, etc.).

Please take note of the following in order to avoid adverse health effects.

- Please do not use the 3D eyewear for purposes other than to watch 3D videos.
- Please keep a distance of at least 2 m away from the screen when watching videos. Watching a video too close to the screen will increase eye fatigue.
- Please do not watch videos continuously for a long period of time. Please take a 15 minutes' break after every hour of watching.
- Please consult a doctor before watching if you or any of your family members have a history of suffering from seizures caused by light sensitivity.
- Please stop watching immediately and take a rest when you feel physically unwell while watching (vomiting, giddiness, nausea, headaches, sore eyes, blurred vision, cramps and numbness in the limbs, etc.). Please consult a doctor if the symptoms persist.
- Please watch a 3D video directly in front of the screen. If you watch a 3D video obliquely from the sides, this may result in physical and eye fatigue.

3D eyewear and 3D emitter preparations

Please use an active shutter-type 3D eyewear that conforms with the VESA standard.

A commercially-available RF type made by Xpand is recommended.

3D eyewear..... Xpand X105-RF

3D emitter..... Xpand AD025-RF-X1

Procedure to watch 3D videos using this projector

1. **Connect the video device to the projector.**
2. **Switch on the power supply to the projector.**
3. **Run the 3D video software and project the video using the projector.**

This has been automatically set up when shipped from the factory. When a 3D video cannot be projected, it may be because the 3D detection signals are not included or because they are not detectable by the projector.

Please manually select the format.

4. **Select the 3D video format.**

(1) Press the "3D Set." button on the remote control.

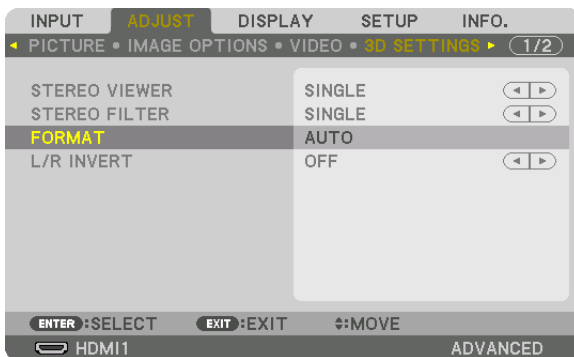

The [3D SETTINGS] screen will be displayed.

(2) Press the ▼ button to align the cursor with the [FORMAT] and press the ENTER button.

The format screen will be displayed.

(3) Select the input signal format using the ▼ button and then press the ENTER button.

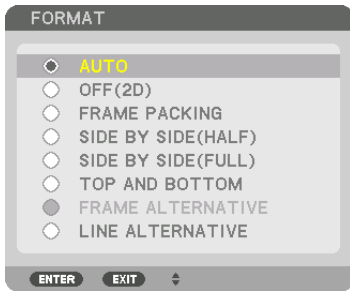

The 3D settings screen will disappear and the 3D video will be projected.

Press the MENU button and the on-screen menu will disappear.

The 3D caution message screen will be displayed when switching to a 3D video (default factory setting when shipped). Please read the “Health Precautions” on the previous page to watch videos in the correct manner. The screen will disappear after 60 seconds or when the ENTER button is pressed. (→ page 109)

5. Turn on the power supply of the 3D eyewear and wear the eyewear to watch the video.

A normal video will be shown when a 2D video is input.

To watch a 3D video in 2D, select [OFF(2D)] in the [FORMAT] screen mentioned above in (3).

NOTE:

- Upon switching to 3D image, the following functions will be cancelled and disabled. [BLANKING], [PIP/PICTURE BY PICTURE], [GEOMETRIC CORRECTION], [EDGE BLENDING] ([GEOMETRIC CORRECTION] and [EDGE BLENDING] adjustment values will be maintained.)
- The output may not automatically switch to a 3D video depending on the 3D input signal.
- Check the operating conditions described in the user manual of the Blu-ray player.
- Please connect the DIN terminal of the 3D emitter to the 3D SYNC of the main projector.
- The 3D eyewear allows videos to be viewed in 3D by receiving synchronized optical signals output from the 3D emitter. As a result, the 3D image quality may be affected by conditions such as the brightness of the surroundings, screen size, viewing distance, etc.
- When playing a 3D video software on a computer, the 3D image quality may be affected if the computer CPU and graphics chip performance are low. Please check the required operating environment of the computer that is stated in the operating manual attached to the 3D video software.
- Depending on the signal, [FORMAT] and [L/R INVERT] may not be able to be selected. Please change the signal in that case.

When videos cannot be viewed in 3D

Please check the following points when videos cannot be viewed in 3D.

Please also read the operating manual attached to the 3D eyewear.

Possible reasons	Solutions
The selected signal does not support 3D output.	Please change the video signal input to one that supports 3D.
The format for the selected signal is turned to [OFF(2D)].	Please change the format in the on-screen menu to [AUTO] or a format that supports 3D.
A eyewear that is not supported by the projector is being used.	Please purchase a commercially-available 3D eyewear or 3D emitter (recommended). (→ page 44)
Please check the following points when a video cannot be viewed in 3D using a 3D eyewear that is supported by the projector.	
The power supply of the 3D eyewear is turned off.	Please turn on the power supply of the 3D eyewear.
The internal battery of the 3D eyewear is flat.	Please charge or replace the battery.
The viewer is located too far away from the screen.	Please get closer to the screen until the video can be seen in 3D. Please turn the L/R INVERT in the on-screen menu to [OFF].
Due to multiple 3D projectors working at the same time in the vicinity, the projectors may interfere with one another. Alternatively, there may be a bright light source near the screen.	Please maintain sufficient distance between the projectors.
	Please keep the light source away from the screen.
	Please turn the L/R INVERT in the on-screen menu to [OFF].
There is an obstacle between the optical receiver of the 3D eyewear and the 3D emitter.	Please remove the obstacle.
The 3D format of the 3D video contents is not supported.	Please check with the company selling the 3D video contents.

11 Controlling the Projector by Using an HTTP Browser

Overview

Using the web browser on the computer, the HTTP server screen of the projector can be displayed to operate the projector.

Possible operations on the HTTP server screen

- Configure the settings required for connecting the projector to the network (wired LAN). (NETWORK SETTINGS)
- Configure the email notification. (ALERT MAIL)
When the projector is connected to a network (wired LAN), notifications on various errors are sent to the email address that has been set up.
- Operate the projector.
Operations such power on/off of the projector, input terminal switchover, volume control, picture control, and lens control etc. can be carried out.
- Configure the [PJLink PASSWORD], [AMX BEACON], and [CRESTRON] etc.

To view the HTTP server screen

1. **Connect the projector to the computer with a LAN cable sold commercially.** (→ page 150)
2. **Select [SETUP] → [NETWORK SETTINGS] → [WIRED LAN] in the on-screen menu to configure the network settings.** (→ page 124)
3. **Start up the web browser on your computer and enter the address or URL in the input field.**
Specify the address or URL as “http://<IP Address of Projector>/index.html”.
The basic HTTP server screen will be displayed.

TIP: The factory setting IP address is [DHCP ON].

NOTE:

- *To use the projector in a network, consult with your network administrator about network settings.*
 - *The display's or button's response can be slowed down or operation may not be accepted depending the settings of your network. Should this happen, consult your network administrator. The projector may not respond if its buttons are repeatedly pressed in rapid intervals. Should this happen, wait a moment and repeat. If you still can't get any response, turn off and back on the projector.*
 - *If the PROJECTOR NETWORK SETTINGS screen does not appear in the web browser, press the Ctrl+F5 keys to refresh your web browser (or clear the cache).*
 - *This projector uses “JavaScript” and “Cookies” and the browser should be set to accept these functions. The setting method will vary depending on the version of browser. Please refer to the help files and the other information provided in your software.*
-

Preparation before Use

Connect the projector to a commercially available LAN cable before engaging in browser operations. (→ page 150)
Operation with a browser that uses a proxy server may not be possible depending on the type of proxy server and the setting method. Although the type of proxy server will be a factor, it is possible that items that have actually been set will not be displayed depending on the effectiveness of the cache, and the contents set from the browser may not be reflected in operation. It is recommended that a proxy server not be used unless it is unavoidable.

Handling of the Address for Operation via a Browser

Regarding the actual address that is entered for the address or entered to the URL column when operation of the projector is via a browser, the host name can be used as it is when the host name corresponding to the IP address of the projector has been registered to the domain name server by a network administrator, or the host name corresponding to the IP address of the projector has been set in the "HOSTS" file of the computer being used.

Example 1: When the host name of the projector has been set to "pj.nec.co.jp", access is gained to the network setting by specifying
http://pj.nec.co.jp/index.html
for the address or the entry column of the URL.

Example 2: When the IP address of the projector is "192.168.73.1", access is gained to the network setting by specifying
http://192.168.73.1/index.html
for the address or the entry column of the URL.

PROJECTOR ADJUSTMENT

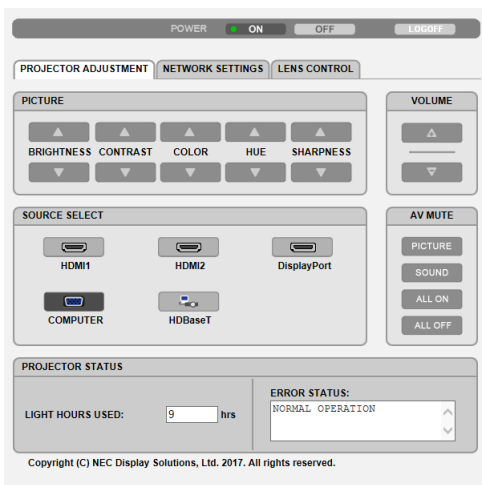

POWER: This controls the power of the projector.

ON Power is switched on.

OFF Power is switched off.

VOLUME: This controls the volume of the projector.

▲ Increases the volume adjustment value for the AUDIO OUT terminal.

▼ Decreases the volume adjustment value for the AUDIO OUT terminal.

AV-MUTE: This controls the mute function of the projector.

PICTURE ON Mutes the video.

PICTURE OFF Cancels the video muting.

SOUND ON Mutes the audio from the AUDIO OUT terminal.

SOUND OFF Cancels the audio muting from the AUDIO OUT terminal.

ALL ON Mutes each of the video, and audio functions for the AUDIO OUT terminal.

ALL OFF Cancels the muting of each of the video, and audio functions for the AUDIO OUT terminal.

PICTURE: Controls the video adjustment of the projector.

BRIGHTNESS ▲ Increases the brightness adjustment value.

BRIGHTNESS ▼ Decreases the brightness adjustment value.

CONTRAST ▲ Increases the contrast adjustment value.

CONTRAST ▼ Decreases the contrast adjustment value.

COLOR ▲ Increases the color adjustment value.

COLOR ▼ Decreases the color adjustment value.

HUE ▲ Increases the hue adjustment value.

HUE ▼ Decreases the hue adjustment value.

SHARPNESS ▲ Increases the sharpness adjustment value.

SHARPNESS ▼ Decreases the sharpness adjustment value.

- The functions that can be controlled will vary depending on the signal being input to the projector. (→ page 88, 89)

SOURCE SELECT: This switches the input connector of the projector.

HDMI1 Switches to the HDMI 1 IN connector.

HDMI2 Switches to the HDMI 2 IN connector.

DisplayPort Switches to the DisplayPort.

COMPUTER Switches to the COMPUTER IN connector.

HDBaseT Switch to image input sent from a transmission device that supports HDBaseT.

PROJECTOR STATUS: This displays the condition of the projector.

LIGHT HOURS USED Displays how many hours the light module has been used.

ERROR STATUS Displays the status of errors occurring within the projector.

LOG OFF: Logging off your projector and returning to the authentication screen (LOGON screen).

NETWORK SETTINGS

http://<IP Address of Projector (Basic)>/index.html

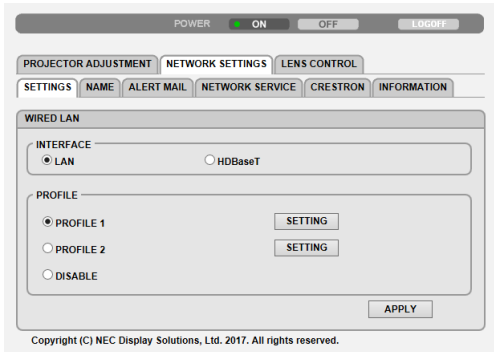

• SETTINGS

WIRED LAN

INTERFACE	Select [LAN] for connecting LAN by wire thru the LAN port. Select [HDBaseT] for connecting LAN by wire thru the HDBaseT IN/Ethernet port.
SETTING	Set for wired LAN.
PROFILE 1/PROFILE 2	Two settings can be set for wired LAN connection. Select PROFILE 1 or PROFILE 2.
DISABLE	Turn off wired LAN connection. The POWER indicator that is informing the STANDBY state will start to blink in orange long interval (→ page 165).
DHCP ON	Automatically assign IP address, subnet mask, and gateway to the projector from your DHCP server.
DHCP OFF	Set IP address, subnet mask, and gateway to the projector assigned by your network administrator.
IP ADDRESS	Set your IP address of the network connected to the projector.
SUBNET MASK	Set your subnet mask number of the network connected to the projector.
GATEWAY	Set the default gateway of the network connected to the projector.
AUTO DNS ON	DHCP server will automatically assign IP address of DNS server connected to the projector.
AUTO DNS OFF	Set your IP address assigned by your network administrator.
DNS	Set your IP address of DNS server connected to the projector.
SAVE	Click this button to save your settings to the projector's memory.
APPLY	Apply your settings to wired LAN.

• NAME

PROJECTOR NAME	Enter a name for your projector so that your computer can identify the projector. A projector name must be 16 characters or less. TIP: Projector name will not be affected even when [RESET] is done from the menu.
HOST NAME	Enter the hostname of the network connected to the projector. A host name must be 16 or less.
DOMAIN NAME	Enter the domain name of the network connected to the projector. A domain name must be 60 characters or less.
SAVE	Click this button to save your settings to the projector's memory.

• ALERT MAIL

ALERT MAIL	This option will notify various errors to your computer via e-mail when using wired LAN. Placing a checkmark will turn on the Alert Mail feature. Clearing a checkmark will turn off the Alert Mail feature. Sample of a message to be sent from the projector: Subject: [Projector] Projector Information THE COOLING FAN HAS STOPPED. [INFORMATION] PROJECTOR NAME: xxxxx LIGHT HOURS USED: xxxx[H]
SENDER'S ADDRESS	Enter sender's address.
SMTP SERVER NAME	Enter the SMTP server name to be connected to the projector.
RECIPIENT'S ADDRESS 1, 2, 3	Enter your recipient's address. Up to three addresses can be entered.
TEST MAIL	Send a test mail to check whether your settings are correct or not <i>NOTE:</i> <ul style="list-style-type: none"> • If you execute a test, you may not receive an Alert mail. Should this happen, check if network settings are correct. • If you entered an incorrect address in a test, you may not receive an Alert mail. Should this happen, check if the Recipient's Address is correct.
SAVE	Click this button to save your settings to the projector's memory.

• NETWORK SERVICE

PJLink PASSWORD	Set a password for PJLink*. A password must be 32 characters or less. Do not forget your password. However, if you forget your password, consult with your dealer.
HTTP PASSWORD	Set a password for HTTP server. A password must be 10 characters or less. When a password is set up, you will be prompted for your user name (arbitrary) and password during LOGON.
AMX BEACON	Turn on or off for detection from AMX Device Discovery when connecting to the network supported by AMX's NetLinX control system. <i>TIP:</i> <i>When using a device that supports AMX Device Discovery, all AMX NetLinX control system will recognize the device and download the appropriate Device Discovery Module from an AMX server. Placing a checkmark will enable detecting the projector from AMX Device Discovery. Clearing a checkmark will disable detecting the projector from AMX Device Discovery.</i>
Extron XTP	Set for connecting this projector to the Extron XTP transmitter. Placing a checkmark will enable to connect with the XTP transmitter. Clearing a checkmark will disable to connect with the XTP transmitter.
SAVE	Click this button to save your settings to the projector's memory.

NOTE: If you forget your password, contact your dealer. Please check 24 digits serial number (XXXX-XXXX-XXXX-XXXX-XXXX-XXXX) displayed on the column for the password.

*What is PJLink?

PJLink is a standardization of protocol used for controlling projectors of different manufacturers. This standard protocol is established by Japan Business Machine and Information System Industries Association (JBMIA) in 2005. The projector supports all the commands of PJLink Class 1. Setting of PJLink will not be affected even when [RESET] is done from the menu.

• CRESTRON

ROOMVIEW for managing from the computer.

DISABLE	Disables ROOMVIEW.
ENABLE	Enables ROOMVIEW.

CRESTRON CONTROL for managing from the controller.

DISABLE	Disables CRESTRON CONTROL.
ENABLE	Enables CRESTRON CONTROL.
IP ADDRESS	Set your IP address of CRESTRON SERVER.
IP ID	Set your IP ID of CRESTRON SERVER.
SAVE	Click this button to save your settings to the projector's memory.

TIP: The CRESTRON settings are required only for use with CRESTRON ROOMVIEW. For more information, visit <http://www.crestron.com>

• INFORMATION

WIRED LAN	Display a list of settings of wired LAN connection.
UPDATE	Reflect settings when they are changed.

LENS CONTROL

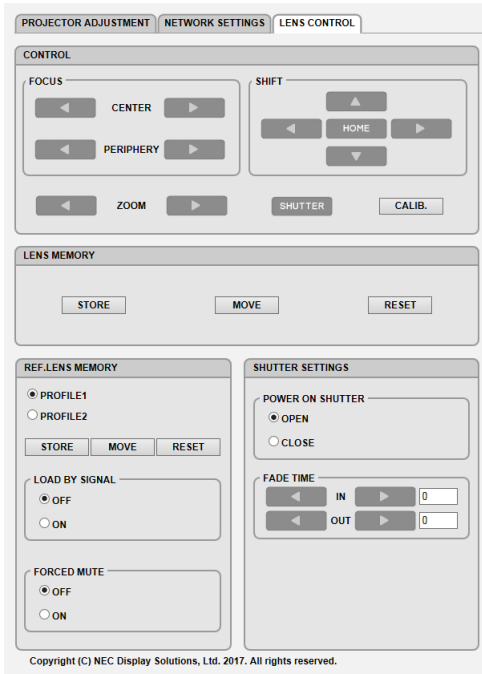

• CONTROL

FOCUS	CENTER	Align the focus around the optical axis.
	PERIPHERY	Align the focus for the screen peripheral area.
ZOOM	◀▶	Finely adjusting the size of an image.
SHIFT	▼▲◀▶	Adjust the projected image's vertical and horizontal position.
	HOME	Return the lens shift position to the home position.
SHUTTER		Turn off the light source temporarily.
⊘ SHUTTER		Turn on the light source.
CALIB.		Correct the adjustable zoom, focus and lens shift range.

• LENS MEMORY

STORE	Store the current adjusted values in memory for each input signal.
MOVE	Applies the adjusted values of LENS SHIFT, ZOOM, and FOCUS to the current signal.
RESET	Return the adjusted values to the last condition.

• REF. LENS MEMORY

PROFILE1/PROFILE2	Select a stored [PROFILE] number.
STORE	Store each adjusted value of LENS SHIFT, ZOOM and FOCUS for the selected profile as the common values for every input signal.
MOVE	Move the lens to the stored values for the selected profile.
RESET	Reset selected [REF. LENS MEMORY] for the selected [PROFILE] to the default factory settings.

3. Convenient Features

LOAD BY SIGNAL	OFF	If input signal is switched, the lens will not shift to the les shift, zoom and focus values for the selected [PROFILE] number.
	ON	If input signal is switched, the lens will shift to the values for the selected [PROFILE] number. If no adjusted values have been stored to [LENS MEMORY], the lens will apply [REF. LENS MEMORY] adjusted values. Alternatively, if no adjusted values have been stored to [REF. LENS MEMORY], the lens will stay unmoved.
FORCED MUTE	OFF	Not turn off the image during les shift.
	ON	Turn off the image during les shift.

• SHUTTER SETTINGS

POWER ON SHUTTER	OPEN	When the power is turned on, the light source comes on and the picture is projected.
	CLOSE	The light source does not come on when the power is turned on. When the SHUTTER button is pressed, the shutter is released and the light source is turned on.
FADE TIME	IN	Set how long the light will take to fade in after the SHUTTER button is pressed. The time can be set from 0 to 10 seconds in increments of 1 second.
	OUT	Set how long the light will take to fade out after the SHUTTER button is pressed. The time can be set from 0 to 10 seconds in increments of 1 second.

⑫ Storing Changes for Lens Shift, Zoom, and Focus [LENS MEMORY]

This function serves to store the adjusted values when using the LENS SHIFT, ZOOM and FOCUS buttons of the projector. Adjusted values can be applied to the signal you selected. This will eliminate the need to adjust lens shift, focus, and zoom at the time of source selection. There are two ways to save adjusted values for lens shift, zoom, and focus.

Function name	Description	page
REF. LENS MEMORY	Adjusted values common to all input signals. At the time of installation, two kinds of adjusted values can be stored. If no adjusted values have been saved to [LENS MEMORY], the lens will apply [REF.LENS MEMORY] adjusted values.	→ page 114
LENS MEMORY	Adjusted values for each input signal. Use the adjusted values for the signal with a different aspect ratio or resolution. The adjusted values can be applied at the time of source selection.	→ page 97

NOTE:

- Be sure to carry out [LENS CALIBRATION] after replacing the lens.

To store your adjusted values in [REF. LENS MEMORY]:

1. Press the **MENU** button.

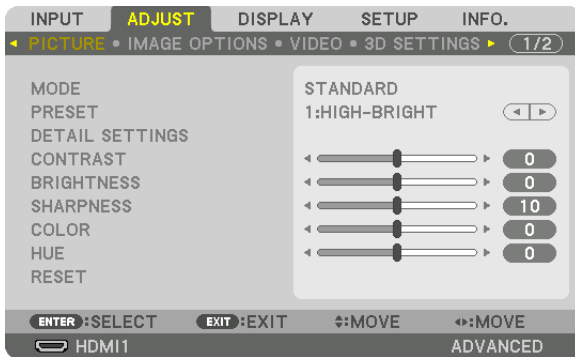

The menu will be displayed.

2. Press the **▶** button to select [SETUP] and press the **ENTER** button.



3. Press the **▶** button to select [INSTALLATION(1)].



4. Press the ▼ button to select [REF. LENS MEMORY] and press the ENTER button.

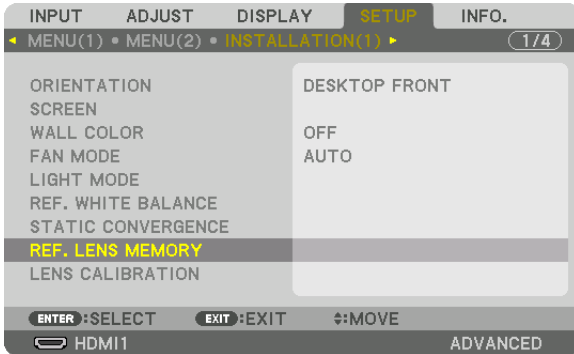

The [REF. LENS MEMORY] screen will be displayed.

5. Make sure [PROFILE] is highlighted, then press the ENTER button.



The [PROFILE] selection screen appears.

6. Press the ▼/▲ buttons to select the [PROFILE] number, then press the ENTER button.



Return to the [REF. LENS MEMORY] settings screen.

7. Select [STORE] and press the ENTER button.

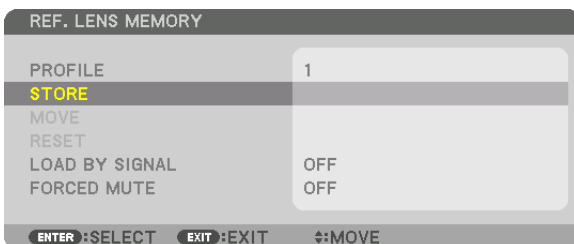

The confirmation screen will be displayed.

8. Press the ◀ button to select and [YES] and press the ENTER button.

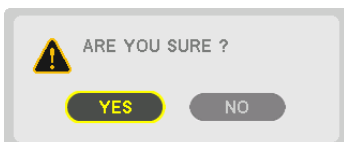

Select a [PROFILE] number and save the adjusted [LENS SHIFT], [ZOOM], and [FOCUS] values to it.

9. Press the MENU button.

The menu will be closed.

TIP:

- To store adjusted values for each input source, use the Lens Memory function. (→ page 97)

To call up your adjusted values from [REF. LENS MEMORY]:

1. Press the MENU button.

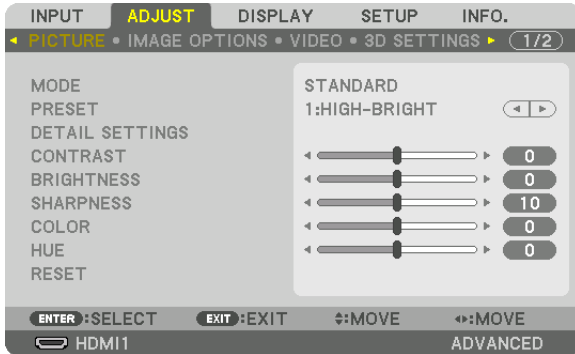

The menu will be displayed.

2. Press the ► button to select [SETUP] and press the ENTER button.



3. Press the ► button to select [INSTALLATION(1)].

4. Press the ▼ button to select [REF. LENS MEMORY] and press the ENTER button.

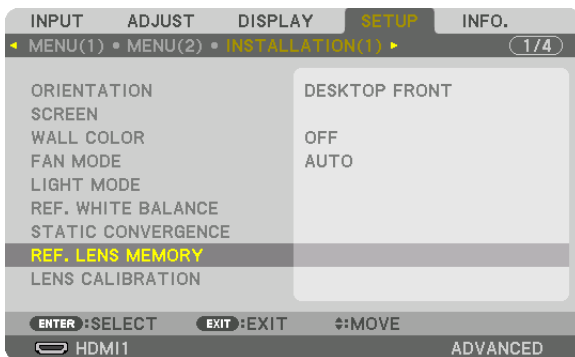

The [REF. LENS MEMORY] screen will be displayed.

5. Make sure [PROFILE] is highlighted, then press the ENTER button.

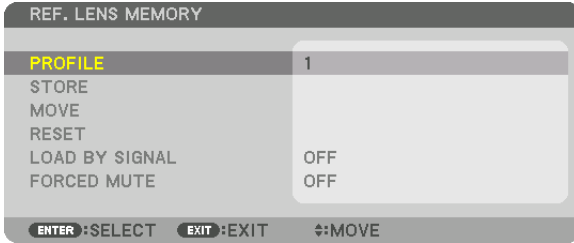

The [PROFILE] selection screen appears.

6. Press the ▼/▲ buttons to select the [PROFILE] number, then press the ENTER button.



Return to the [REF. LENS MEMORY] settings screen.

7. Select [MOVE] and press the ENTER button.

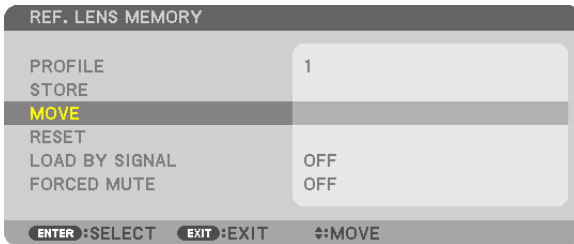

The lens will shift based on the adjusted values stored in the selected [PROFILE].

8. Press the ◀ button to select and [YES] and press the ENTER button.

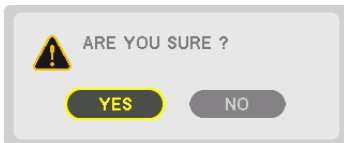

The adjusted values will be applied to the current signal. .

9. Press the MENU button.

The menu will be closed.

TIP:

To call up the stored values from [LENS MEMORY]:

1. From the menu, select [ADJUST] → [LENS MEMORY] → [MOVE] and press the ENTER button.



The confirmation screen will be displayed.

2. Press the ◀ button to select and [YES] and press the ENTER button.

During projection, if the adjusted values for an input signal have been saved, the lens will shift. If not, the lens will shift according to the adjusted values stored in the selected [REF. LENS MEMORY] [PROFILE] number.

To automatically apply the stored values at the time of source selection:

1. From the menu, select [SETUP] → [REF. LENS MEMORY] → [LOAD BY SIGNAL] and press the ENTER button.



2. Press the ▼ button to select and [ON] and press the ENTER button.

This will move the lens automatically to the position at the time of source selection according to the adjusted values.

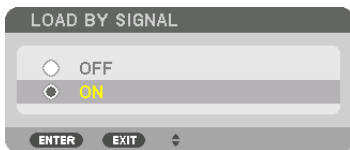

NOTE: The Lens Memory function may not produce a completely aligned image (due to tolerances in the lenses) using the adjusted values stored in the projector. After calling up and applying the stored values from the Lens Memory function, finely adjust the lens shift, zoom and focus to produce the best possible image.

4. Multi-Screen Projection

① Things that can be done using multi-screen projection

This projector can be used singly or arranged in multiple units for multi-screen projection. We will introduce an example using two projection screens here.

Case 1

Using a single projector to project two types of videos at the same time
[PIP/PICTURE BY PICTURE]

Case 2

Using four projectors to project video with a resolution of 3840 × 2160 pixels
[TILING]

Case 1. Using a single projector to project two types of videos [PIP/PICTURE BY PICTURE]

Connection example and projection image

In the case of [PICTURE BY PICTURE]

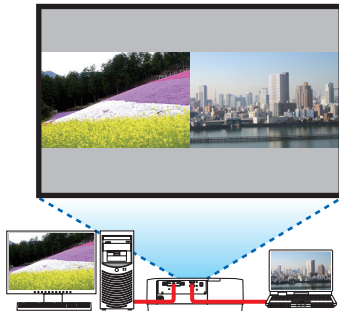

In the case of [PIP]

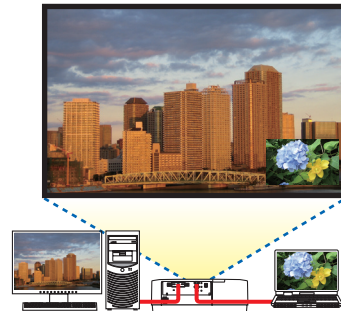

On-screen menu operations

Display [DISPLAY] → [PIP/PICTURE BY PICTURE] → [MODE] screen in the on-screen menu and select [PIP] or [PICTURE BY PICTURE].

For details, please refer to “4-2 Displaying Two Pictures at the Same Time”. (→ page 64)

Case 2. Using four projectors to project videos with a resolution of 3840 × 2160 pixels [TILING]

Connection example and projection image

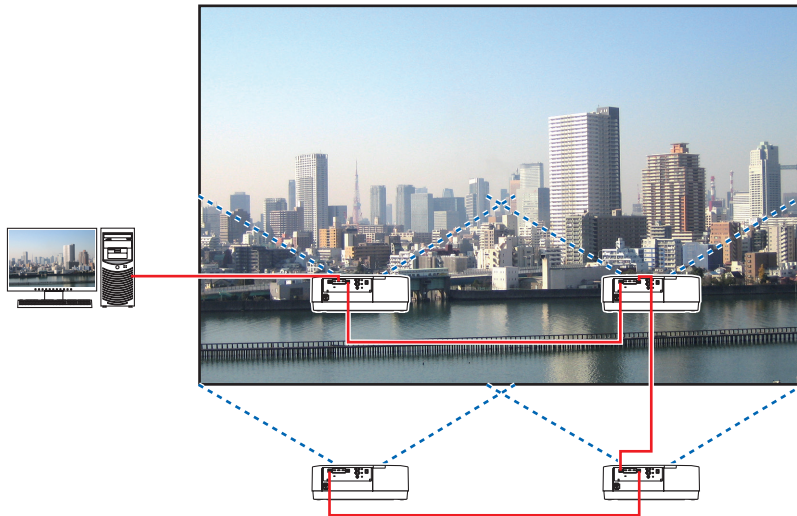

On-screen menu operations

1 Four similar videos are displayed when four projectors are projected.

Please request the retail store to adjust the projection position of each projector.



NOTE:

- When setting up the projector, assign a unique control ID to each projector.
- Set the "Color setting" and "DeepColor setting" on your Blu-ray player or computer to "Auto". Refer to the owner's manual accompanied with your Blu-ray player or computer for more information.
- Connect an HDMI output of your Blu-ray player or computer to the first projector and then connect to HDBaseT IN/Ethernet port of the second and subsequent projectors.
- Selecting another input source on the second and subsequent projectors will disable the HDBaseT repeater function.

4. Multi-Screen Projection

2 Operate the on-screen menu using the four respective projectors to divide the image into four portions.

Display [DISPLAY] → [MULTI SCREEN] → [PICTURE SETTING] Screen in the on-screen menu and select [TILING].

(1) In the screen for setting the number of horizontal units, select [2 UNITS]. (number of units in the horizontal direction)

(2) In the screen for setting the number of vertical units, select [2 UNITS]. (number of units in the vertical direction)

(3) In the screen for setting the horizontal order, select [1st UNIT] or [2nd UNIT].

(look at the screens, the one on the left is the [1st UNIT] while the one on the right is the [2nd UNIT])

(4) In the screen for setting the vertical order, select the [1st UNIT] or the [2nd UNIT].

(look at the screens, the one at the top is the [1st UNIT] while the one at the bottom is the [2nd UNIT])



3 Adjust the lens shift of each projector to fine-tune the boundaries of the screen.

For further fine-tuning, adjust using [DISPLAY] → [EDGE BLENDING] in the on-screen menu for each projector. For details, please refer to “4-3 Displaying a Picture Using [EDGE BLENDING]”.

(→ page 68)

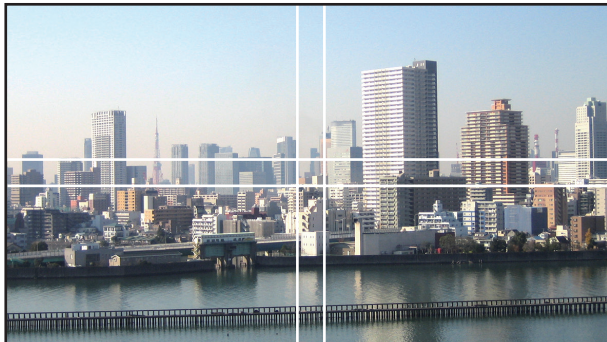

Things to note when installing projectors

- Leave sufficient space on the left and right of the projector so that the intake and exhaust vents of the projector are not obstructed. When the intake and exhaust vents are obstructed, the temperature inside the projector will rise and this may result in a malfunction.

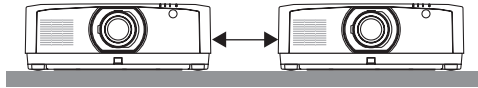

- Please do not pile up the projectors directly on top of one another when installing them. When the projectors are piled up on top of one another, they may fall down, resulting in damage and failure. The following installation is recommended when combining the installation of two projectors for multi-screen projection. Please leave sufficient space on the left and right of the projector.

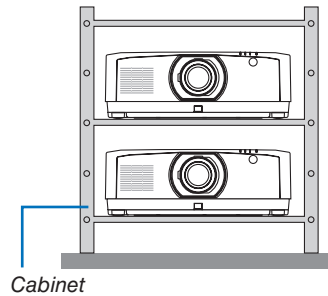

WARNING

Please request the retail store for special installation services such as when mounting the projector to the ceiling. Never carry out the installation by yourself. The projector may fall down and result in injury. Please use a sturdy cabinet that can withstand the weight of the projector for the installation. Please do not pile up the projectors directly on top of one another.

NOTE:

- For the range of the projection distance, please refer to the Appendix "Throw distance and screen size". (→ page 152)

② Displaying Two Pictures at the Same Time

The projector has a feature that allows you to view two different signals simultaneously. You have two modes: PIP mode and PICTURE BY PICTURE mode.

The projection video in the first screen display is known as the main display while the projection video that is called out subsequently is known as the sub-display.

Select the projection function under [DISPLAY] → [PIP/PICTURE BY PICTURE] → [MODE] in the on-screen menu (the default factory setting when shipped is PIP). (→ page 99)

- A single screen is projected when power is turned on.

Picture in Picture function

A small sub-display is displayed inside the main display.

The sub-display can be set up and adjusted as follows. (→ page 99)

- Select whether to display the sub-display at the top right, top left, bottom right or bottom left of the screen (the size of the sub-display can be selected and the position can be fine-tuned)
- Switch the main display with the sub-display

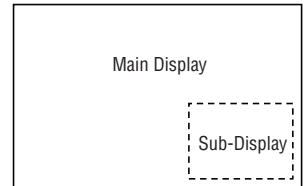

Picture by picture function

Display the main display and sub-display side by side.

The main display and sub-display can be set up and adjusted as follows. (→ page 100)

- Selecting the display boundary (ratio) of the main display and sub-display
- Switch the main display and sub-display

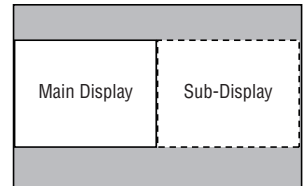

Input terminals that can be used for the main screen and sub-screen.

The main screen and sub-screen can provide the following input terminals.

- The main display and sub-display support computer signals up to WUXGA@60HzRB.

		Sub-Display or additional display				
		HDMI1	HDMI2	DisplayPort	COMPUTER	HDBaseT
Main Display	HDMI1	No	Yes	Yes	Yes	Yes
	HDMI2	Yes	No	Yes	Yes	Yes
	DisplayPort	Yes	Yes	No	Yes	Yes
	COMPUTER	Yes	Yes	Yes	No	Yes
	HDBaseT	Yes	Yes	Yes	Yes	No

NOTE:

- Some signals may not appear depending on the resolution.

Projecting two screens

1. Press the **MENU** button to display the on-screen menu and select **[DISPLAY]** → **[PIP/PICTURE BY PICTURE]**.

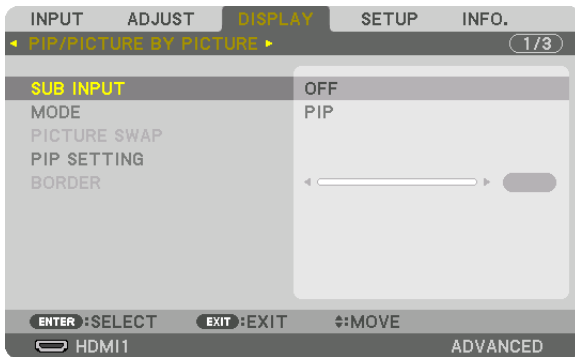

This displays the **[PIP/PICTURE BY PICTURE]** screen in the on-screen menu.

2. Select **[SUB INPUT]** using the **▼/▲** buttons, and press the **ENTER** button.

This displays the **[SUB INPUT]** screen.

3. Select the input signal using the **▼/▲** buttons, and press the **ENTER** button.

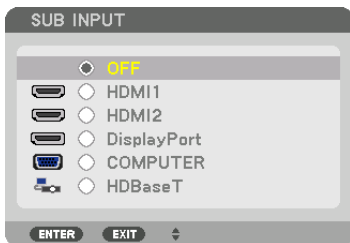

* This screen belongs to a HDBaseT model.

The **[PIP]** (**PICTURE IN PICTURE**) or **[PICTURE BY PICTURE]** screen set up under **[MODE]** is projected. (→ page 99)

- When the signal name is displayed in grey, this means that it cannot be selected.
- The signal can also be selected by pressing the **PIP** button or **PBP/POP** button on the remote control.

4. Press the **MENU** button.

The on-screen menu will disappear.

5. When returning to single screen, display the **[PIP/PICTURE BY PICTURE]** screen one more time and select **[OFF]** in the **[SUB INPUT]** screen of the Step 3.

TIP:

- During dual-screen projection, if the selected input is not supported by the sub-screen, the sub-screen will appear as a black screen.

Switching the main display with the sub-display and vice versa

1. Press the **MENU** button to display the on-screen menu and select **[DISPLAY]** → **[PIP/PICTURE BY PICTURE]**.

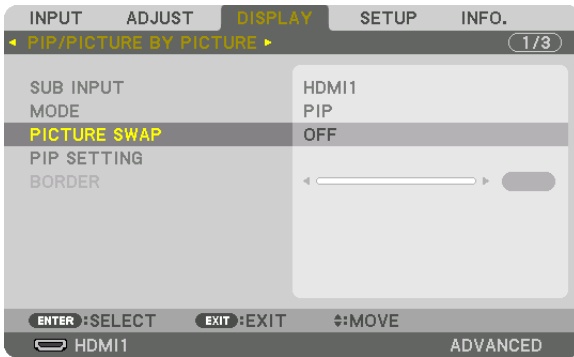

This displays the **[PIP/PICTURE BY PICTURE]** screen in the on-screen menu.

2. Select **[PICTURE SWAP]** using the **▼/▲** buttons and then press the **ENTER** button.
Display the screen for switching the display positions.
3. Select **[ON]** using the **▼** button and then press the **ENTER** button.

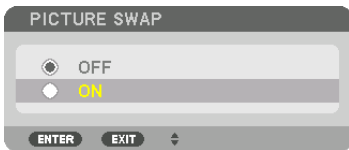

The video of the main display will switch with that of the sub-display.

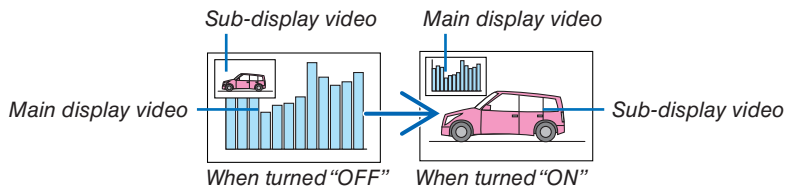

The signal output from the **HDBaseT OUT/Ethernet** terminal does not change even if the display positions are switched.

4. Press the **MENU** button.

The on-screen menu will disappear.

Restrictions

- The following operations are enabled only for the main display.
 - Audio-visual adjustments
 - Video magnification / compression using the partial D-ZOOM/ZOOM +/- buttons.
However, magnification / compression is up to the positions set in [PICTURE BY PICTURE BORDER] only.
 - TEST PATTERN
- The following operations are enabled for both the main display and sub-display. These operations cannot be applied individually.
 - Momentary deletion of video / audio
 - Video pause
- [PIP/PICTURE BY PICTURE] cannot be used when a 3D video is being displayed.
- When using the [PIP/PICTURE BY PICTURE] function, [DYNAMIC CONTRAST] can not be used.
- [PIP/PICTURE BY PICTURE] cannot be used when the signal input has a resolution of 1920 × 1200 or more.
- The HDBaseT OUT/Ethernet port has a repeater function. The output resolution is limited by the maximum resolution of the connected monitor and projector.

③ Displaying a Picture Using [EDGE BLENDING]

A high resolution video can be projected on an even bigger screen by combining multiple projectors on the left, right, top and bottom.

This projector is equipped with an “EDGE BLENDING Function” that makes the edges (boundaries) of the projection screen indistinguishable.

NOTE:

- For projector throw distances, refer to “Throw distance and screen size” on page 152.
- Before performing the Edge Blending function, place the projector in the correct position so that the image becomes square in the appropriate size, and then make optical adjustments (lens shift, focus, and zoom).
- Adjust the brightness of each projector using [REF. LIGHT ADJUST] under [LIGHT MODE]. In addition, use [REF. WHITE BALANCE] to adjust the [CONTRAST], [BRIGHTNESS] and [UNIFORMITY].

Before explaining use of the Edge Blending function

This section explains the case for “Example: Placing two projectors side by side”. As shown, the projected image on the left is referred to as “Projector A” and the projected image on the right is referred to “Projector B”. Unless otherwise specified hereinafter, the “projector” is used to mean both A and B.

Example: Placing two projectors side by side

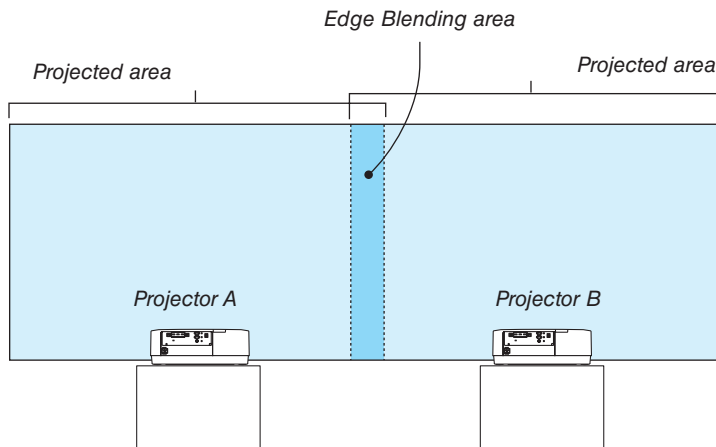

Preparation:

- Turn on the projector and display a signal.
- When performing settings or adjustments using one remote control, enable the [CONTROL ID] for assigning ID to each projector so as not to activate the other projectors. (→ page 121)

Setting the overlap of projection screens

① Enable [EDGE BLENDING].

1 Press the “Edge Blend.” button.

The [EDGE BLENDING] screen will be displayed. Align the cursor with [MODE] and then press the ENTER button. The mode screen will be displayed.

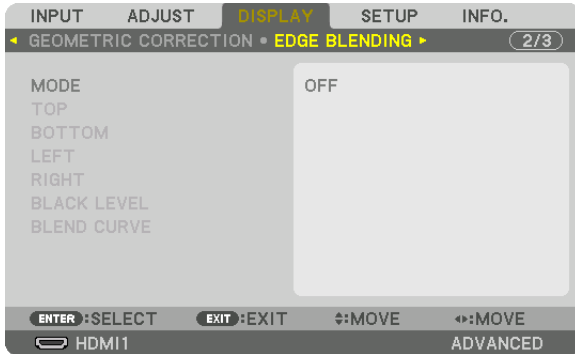

2 Select [MODE] → [ON] and press the ENTER button.

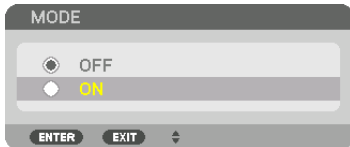

This enables the Edge Blending function. The following menu items are available: [TOP], [BOTTOM], [LEFT], [RIGHT], [BLACK LEVEL], and [BLEND CURVE]

3 Select [RIGHT] for Projector A and [LEFT] for Projector B.

Press the ENTER button.

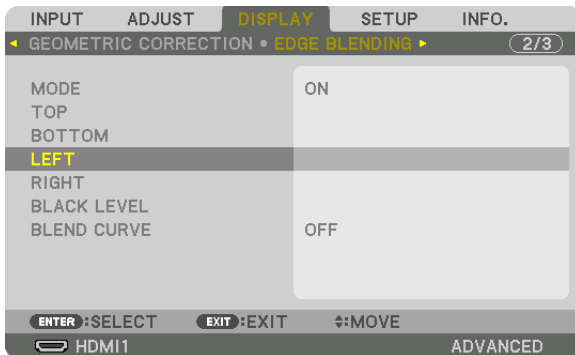

The following items are available:
[CONTROL], [MARKER], [RANGE], and [POSITION]

4 Select [CONTROL] → [ON] and press the ENTER button.

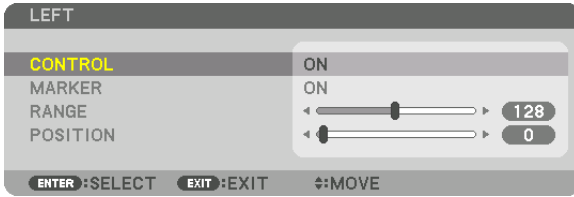

Each [TOP], [BOTTOM], [LEFT], [RIGHT], and [BLACK LEVEL] has its own [CONTROL], [MARKER], [RANGE], and [POSITION].

- For Projector A, set the [CONTROL] for the [TOP], [LEFT] and [BOTTOM] to [OFF]. Similarly for Projector B, set the [CONTROL] for the [TOP], [RIGHT] and [BOTTOM] to [OFF].

② Adjust [RANGE] and [POSITION] to determine an area of overlapped edges of images projected from each projector.

Turning on [MARKER] will display markers in magenta and green.

The magenta marker is used for [RANGE] and green one for [POSITION].

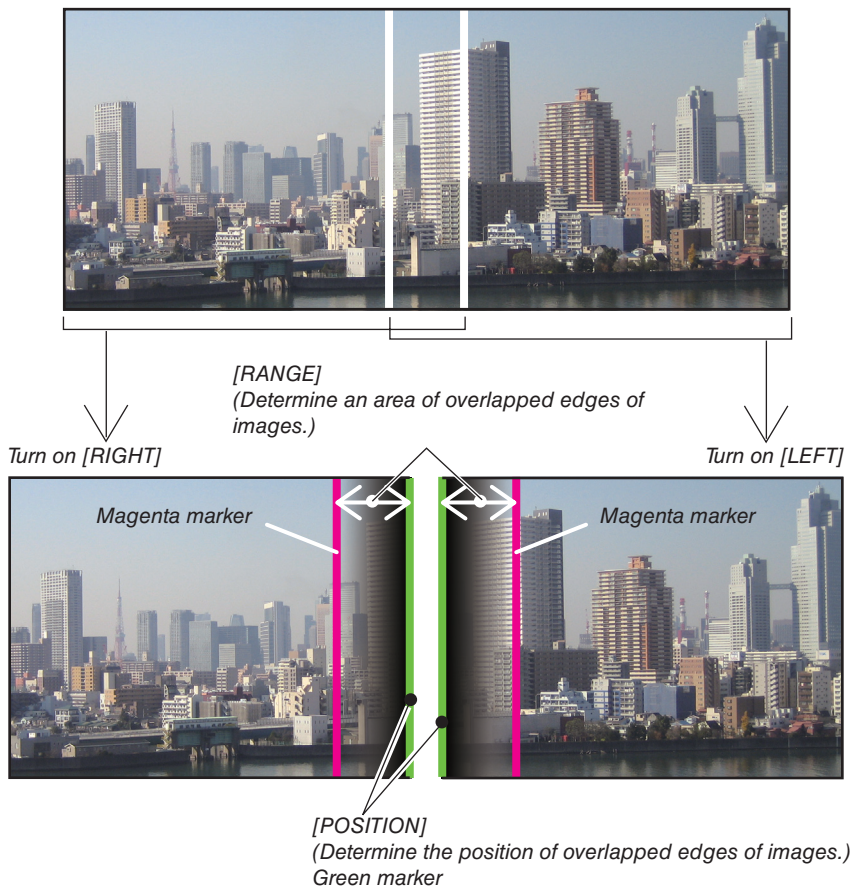

* The 2 screens are separated in the diagram for explanatory purposes.

1 Adjust [RANGE].

Use the ◀ or ▶ button to adjust the overlapped area.

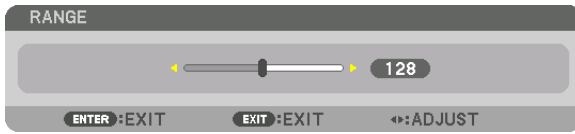

TIP:

- Adjust to overlap one projector's marker with the other projector's marker.

2 Adjust [POSITION].

Use the ◀ or ▶ button to align one edge with the other edge of overlapped images.

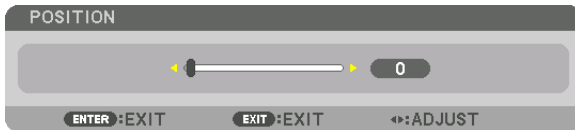

TIP:

- When displaying a signal with a different resolution, perform the Edge Blending function from the start.
- Setting of [MARKER] will not be saved and return to [OFF] when the projector is turned off.
- To display or hide the marker while the projector is running, turn on or off [MARKER] from the menu.

[BLEND CURVE]

Adjust the brightness of the overlapped section on the screens. According to the necessity, adjust the brightness of the overlapped section on the screens by the [BLEND CURVE] AND [BLACK LEVEL].

- Set the [MODE] to [ON] for selecting [BLEND CURVE] and [BLACK LEVEL].

Selecting an option for the [BLEND CURVE]

By controlling the graduation of the overlapped section on the screens, it makes the border on the projected screens inconspicuous. Select the optimal option among nine.

1. On the On-Screen Menu, move the cursor onto the [DISPLAY] → [EDGE BLENDING] → [BLEND CURVE] and then press the ENTER. The option setting screen for the [BLEND CURVE] is displayed on.



2. Select one option among nine by ▲ or ▼.

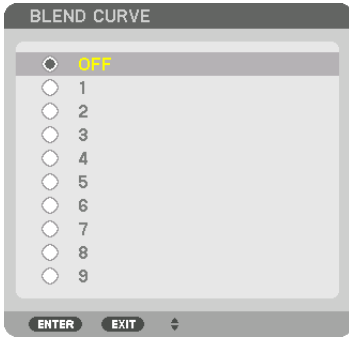

Black Level Adjustment

This adjusts the black level of the overlapping area and the non-overlapping area of the multi-screen (EDGE BLENDING). Adjust the brightness level if you feel the difference is too large.

NOTE:

This function is enabled only when [MODE] is turned on.

Adjustable area varies depending on what combination of [TOP], [BOTTOM], [LEFT] and [RIGHT] are turned on.

Example: Adjusting the Black Level when placing two projectors side by side

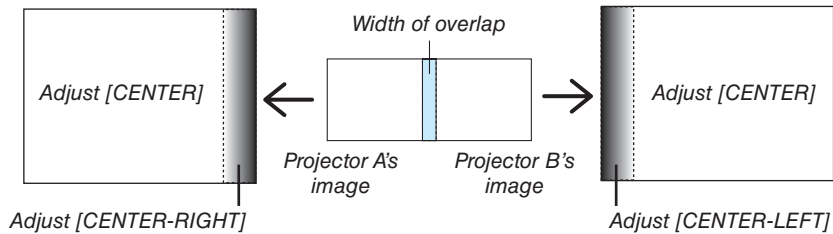

1. Select [DISPLAY] → [EDGE BLENDING] → [BLACK LEVEL] and press the ENTER button.

The screen will switch to the black level adjustment screen.

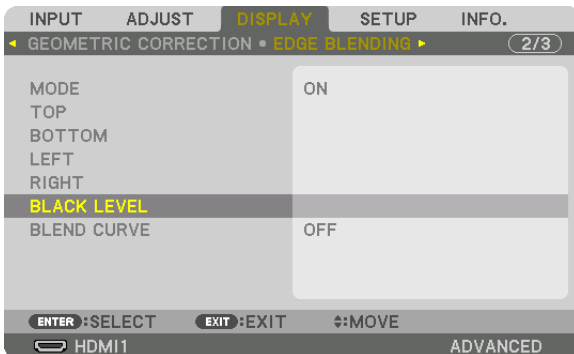

2. Use the ▼ or ▲ button to select an item and use the ◀ or ▶ to adjust the black level.

Do this for the other projector if necessary.

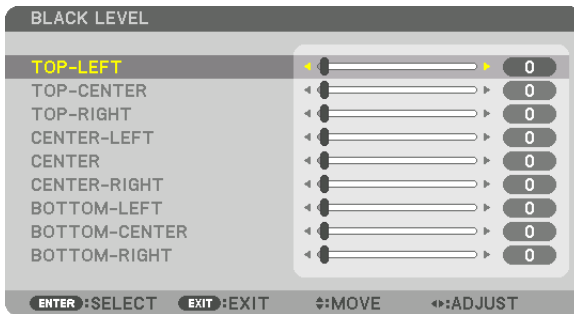

9-segmented portions for Black Level adjustment

The center projector

This function adjusts the brightness level of 9-segmented portions for the center projector and 4-segmented portions for the left bottom projector as shown below.

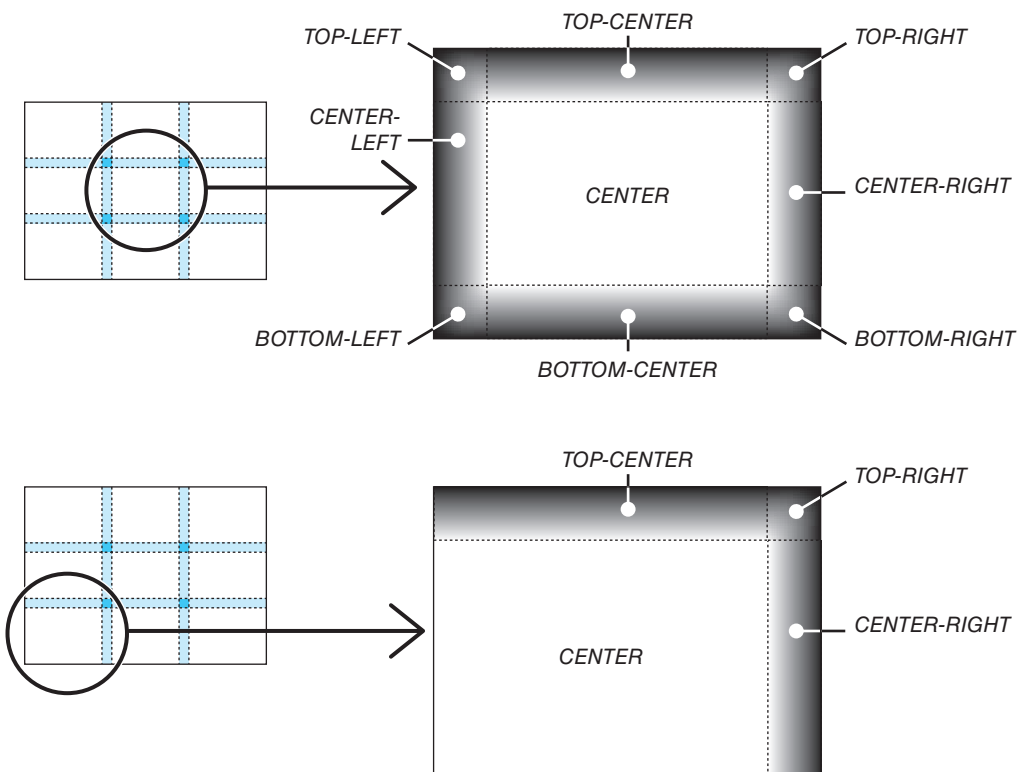

TIP:

- The number of black level division screens (maximum of nine divisions) changes depending on the number of edge blending positions selected (top, bottom, right, left). In addition, when the top / bottom and left / right ends are selected, the corner division screen appears.
- The edge blending width is the width set in the range and the corner is formed by the intersecting area of the top / bottom ends or left / right ends.
- The [BLACK LEVEL] can be adjusted to make it brighter only.

5. Using On-Screen Menu

① Using the Menus

NOTE: The on-screen menu may not be displayed correctly while interlaced motion video image is projected.

1. Press the **MENU** button on the remote control or the projector cabinet to display the menu.

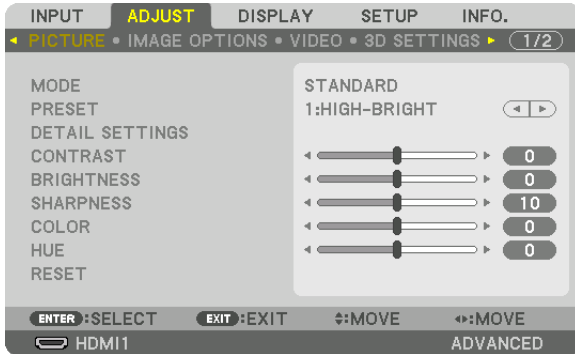

NOTE: The commands such as ENTER, EXIT, ▲▼, ◀▶ in the bottom show available buttons for your operation.

2. Press the ◀▶ buttons on the remote control or the projector cabinet to display the submenu.
3. Press the ENTER button on the remote control or the projector cabinet to highlight the top item or the first tab.
4. Use the ▲▼ buttons on the remote control or the projector cabinet to select the item you want to adjust or set.
You can use the ◀▶ buttons on the remote control or the projector cabinet to select the tab you want.
5. Press the ENTER button on the remote control or the projector cabinet to display the submenu window.
6. Adjust the level or turn the selected item on or off by using the ▲▼◀▶ buttons on the remote control or the projector cabinet.
Changes are stored until adjusted again.
7. Repeat steps 2-6 to adjust an additional item, or press the EXIT button on the remote control or the projector cabinet to quit the menu display.

NOTE: When a menu or message is displayed, several lines of information may be lost, depending on the signal or settings.

8. Press the **MENU** button to close the menu.
To return to the previous menu, press the **EXIT** button.

2 Menu Elements

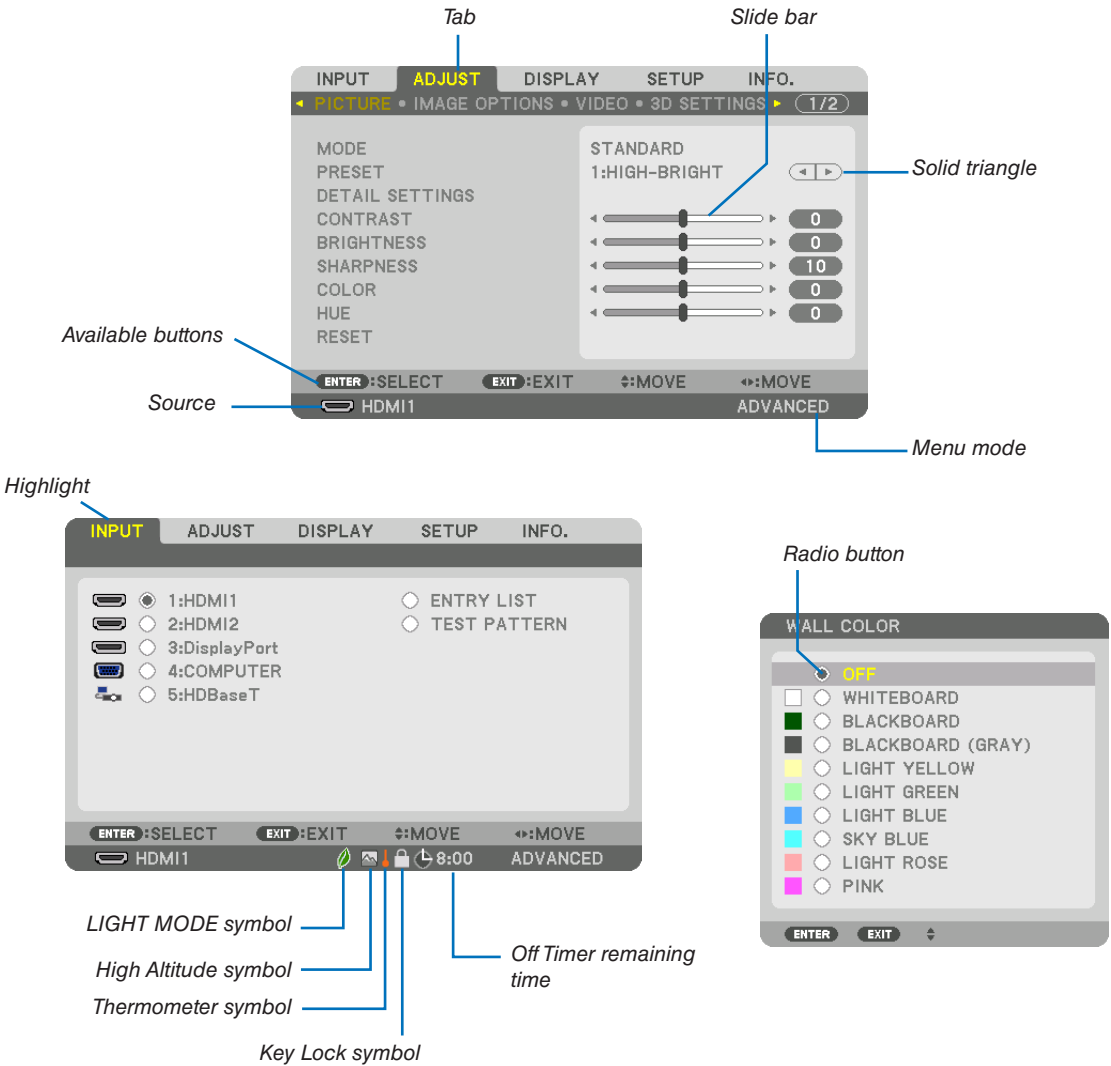

Menu windows or dialog boxes typically have the following elements:

- Highlight.....Indicates the selected menu or item.
- Solid triangleIndicates further choices are available. A highlighted triangle indicates the item is active.
- Tab.....Indicates a group of features in a dialog box. Selecting on any tab brings its page to the front.
- Radio button.....Use this round button to select an option in a dialog box.
- SourceIndicates the currently selected source.
- Menu modeIndicates the current menu mode: BASIC or ADVANCED.
- Off Timer remaining time....Indicates the remaining countdown time when the [OFF TIMER] is preset.
- Slide barIndicates settings or the direction of adjustment.
- LIGHT MODE symbol.....Indicates [LIGHT MODE] is set.
- Key Lock symbolIndicates the [CONTROL PANEL LOCK] is enabled.
- Thermometer symbolIndicates the [LIGHT MODE] is forcibly set to [ON] mode because the internal temperature is too high.
- High Altitude symbolIndicates the [FAN MODE] is set to [HIGH ALTITUDE] mode.

3 List of Menu Items

• Basic menu items are indicated by shaded area.

Some menu items are not available depending on the input source.

Menu Item		Default	Options	
INPUT	1:HDMI1	*		
	2:HDMI2	*		
	3:DisplayPort	*		
	4:COMPUTER	*		
	5:HDBaseT			
	ENTRY LIST			
	TEST PATTERN			
ADJUST	MODE	STANDARD	STANDARD, PROFESSIONAL	
	PRESET	*	AUTO, 1:HIGH-BRIGHT, 2:PRESENTATION, 3:VIDEO, 4:MOVIE, 5:GRAPHIC, 6:sRGB, 7:DICOM SIM.	
	DETAIL SETTINGS	GENERAL		
		REFERENCE	*	HIGH-BRIGHT, PRESENTATION, VIDEO, MOVIE, GRAPHIC, sRGB, DICOM SIM.
		GAMMA CORRECTION*1		DYNAMIC, NATURAL, BLACK DETAIL
		SCREEN SIZE*2	*	LARGE, MEDIUM, SMALL
		COLOR TEMPERATURE*3	*	
		DYNAMIC CONTRAST	*	OFF, MOTION IMAGE, STILL IMAGE
		LIGHT ADJUST	*	
		WHITE BALANCE		
		CONTRAST R	0	
		CONTRAST G	0	
		CONTRAST B	0	
		BRIGHTNESS R	0	
		BRIGHTNESS G	0	
		BRIGHTNESS B	0	
		COLOR CORRECTION		
	RED	0	HUE, SATURATION	
	GREEN	0	HUE, SATURATION	
	BLUE	0	HUE, SATURATION	
	YELLOW	0	HUE, SATURATION	
	MAGENTA	0	HUE, SATURATION	
	CYAN	0	HUE, SATURATION	
	CONTRAST	50		
	BRIGHTNESS	50		
	SHARPNESS	10		
	COLOR	50		
	HUE	0		
	VOLUME			
	RESET			
	IMAGE OPTIONS	CLOCK	*	
		PHASE	*	
		HORIZONTAL	*	
VERTICAL		*		
BLANKING		*	TOP, BOTTOM, LEFT, RIGHT	
OVERSCAN			AUTO, 0[%], 5[%], 10[%]	
ASPECT RATIO		AUTO	(HDTV/SDTV) AUTO, NORMAL, 4:3, LETTERBOX, WIDE SCREEN, ZOOM, FULL	
INPUT RESOLUTION*4		AUTO	(COMPUTER) AUTO, NORMAL, 4:3, 5:4, 16:9, 15:9, 16:10, FULL, NATIVE	
VIDEO	NOISE REDUCTION	RANDOM NR	*	OFF, LOW, MEDIUM, HIGH
		MOSQUITO NR	OFF	OFF, LOW, MEDIUM, HIGH
		BLOCK NR	OFF	OFF, LOW, MEDIUM, HIGH
	DEINTERLACE	NORMAL	NORMAL, MOVIE, STILL	
	CONTRAST ENHANCEMENT	MODE	AUTO	OFF, AUTO, NORMAL
		GAIN		
	SIGNAL TYPE	AUTO	AUTO, RGB, REC601, REC709, REC2020	
	VIDEO LEVEL	AUTO	AUTO, NORMAL, ENHANCED, SUPER WHITE	
HDR MODE*5	AUTO	AUTO, OFF, ON		

* The asterisk (*) indicates that the default setting varies depending on the signal.

*1 The [GAMMA CORRECTION] item is available when an item other than [DICOM SIM.] is selected for [REFERENCE].

*2 The [SCREEN SIZE] item is available when [DICOM SIM.] is selected for [REFERENCE].

*3 When [HIGH-BRIGHT] is selected in [REFERENCE], the [COLOR TEMPERATURE] is not available.

*4 The [INPUT RESOLUTION] item can be selected for COMPUTER input.

*5 The [HDR MODE] item is available exclusively for 4K signal.

5. Using On-Screen Menu

Menu Item		Default	Options		
ADJUST	3D SETTINGS	STEREO VIEWER	SINGLE, DUAL LEFT, DUAL RIGHT		
		STEREO FILTER	SINGLE, DUAL LEFT, DUAL RIGHT		
		FORMAT	AUTO, OFF(2D), FRAME PACKING, SIDE BY SIDE(HALF), SIDE BY SIDE(FULL), TOP AND BOTTOM, FRAME ALTERNATIVE, LINE ALTERNATIVE		
		L/R INVERT	OFF, ON		
	LENS MEMORY	STORE MOVE RESET			
DISPLAY	PIP/PICTURE BY PICTURE	SUB INPUT	OFF, HDMI1, HDMI2, DisplayPort, COMPUTER, HDBaseT		
		MODE	PIP, PICTURE BY PICTURE		
		PICTURE SWAP	OFF, ON		
		PIP SETTING	START POSITION	TOP-LEFT	TOP-LEFT, TOP-RIGHT, BOTTOM-LEFT, BOTTOM-RIGHT
			HORIZONTAL POSITION		
			VERTICAL POSITION		
		BORDER	SIZE	MEDIUM	LARGE, MEDIUM, SMALL
	GEOMETRIC CORRECTION	MODE	OFF	OFF, KEYSTONE, CORNERSTONE, HORIZONTAL CORNER, VERTICAL CORNER, WARP, PC TOOL	
		KEYSTONE	HORIZONTAL		
			VERTICAL		
			TILT		
			THROW RATIO		
		CORNERSTONE		TOP-LEFT, TOP, TOP-RIGHT, LEFT, RIGHT, BOTTOM-LEFT, BOTTOM, BOTTOM-RIGHT	
		HORIZONTAL CORNER		TOP-LEFT, TOP, TOP-RIGHT, LEFT, RIGHT, BOTTOM-LEFT, BOTTOM, BOTTOM-RIGHT	
		VERTICAL CORNER		TOP-LEFT, TOP, TOP-RIGHT, LEFT, RIGHT, BOTTOM-LEFT, BOTTOM, BOTTOM-RIGHT	
	WARP		TOP-LEFT, TOP, TOP-RIGHT, LEFT, RIGHT, BOTTOM-LEFT, BOTTOM, BOTTOM-RIGHT		
	PC TOOL	OFF	OFF, 1, 2, 3		
	RESET				
	EDGE BLENDING	MODE	OFF	OFF, ON	
		TOP	CONTROL	ON	OFF, ON
			MARKER	OFF	OFF, ON
			RANGE		
			POSITION		
		BOTTOM	CONTROL	ON	OFF, ON
			MARKER	OFF	OFF, ON
			RANGE		
			POSITION		
		LEFT	CONTROL	ON	OFF, ON
			MARKER	OFF	OFF, ON
			RANGE		
			POSITION		
RIGHT		CONTROL	ON	OFF, ON	
		MARKER	OFF	OFF, ON	
		RANGE			
		POSITION			
BLACK LEVEL		TOP-LEFT			
		TOP-CENTER			
		TOP-RIGHT			
	CENTER-LEFT				
	CENTER				
	CENTER-RIGHT				
	BOTTOM-LEFT				
BOTTOM-CENTER					
BOTTOM-RIGHT					
BLEND CURVE	5	OFF, 1, 2, 3, 4, 5, 6, 7, 8, 9			

5. Using On-Screen Menu

Menu Item		Default	Options		
DISPLAY	MULTI SCREEN	MODE	OFF	OFF, ON	
		CONTRAST W			
		CONTRAST R			
		CONTRAST G			
		CONTRAST B			
		BRIGHTNESS W			
		BRIGHTNESS R			
		BRIGHTNESS G			
	BRIGHTNESS B				
	PICTURE SETTING	MODE	OFF	OFF, ZOOM, TILING	
		ZOOM	HORIZONTAL ZOOM		
			VERTICAL ZOOM		
			HORIZONTAL POSITION		
TILING		VERTICAL POSITION			
	WIDTH		1 UNIT, 2 UNITS, 3 UNITS, 4 UNITS		
	HEIGHT		1 UNIT, 2 UNITS, 3 UNITS, 4 UNITS		
	HORIZONTAL POSITION		1st UNIT, 2nd UNIT, 3rd UNIT, 4th UNIT		
	VERTICAL POSITION		1st UNIT, 2nd UNIT, 3rd UNIT, 4th UNIT		
SETUP	MENU(1)	LANGUAGE	ENGLISH	ENGLISH, DEUTSCH, FRANÇAIS, ITALIANO, ESPAÑOL, SVENSKA, 日本語 DANSK, PORTUGUÊS, ČEŠTINA, MAGYAR, POLSKI, NEDERLANDS, SUOMI NORSK, TÜRKÇE, РУССКИЙ, عربي, Ελληνικά, 简体中文, 한국어 ROMÂNĂ, HRVATSKA, БЪЛГАРСКИ, INDONESIA, हिन्दी, ไทย, ئۇيغۇر, 繁體中文, Tiếng Việt	
		COLOR SELECT	COLOR	COLOR, MONOCHROME	
		INPUT DISPLAY	ON	OFF, ON	
		MESSAGE DISPLAY	ON	OFF, ON	
		ID DISPLAY	ON	OFF, ON	
		3D CAUTION MESSAGE	ON	OFF, ON	
		DISPLAY TIME	AUTO 45 SEC	MANUAL, AUTO 5 SEC, AUTO 15 SEC, AUTO 45 SEC	
		MENU ANGLE		0°, 90°, 270°	
	MENU(2)	MENU POSITION	HORIZONTAL POSITION		
			VERTICAL POSITION		
			RESET		
	INSTALLATION(1)	ORIENTATION	AUTO	AUTO, DESKTOP FRONT, CEILING REAR, DESKTOP REAR, CEILING FRONT	
		SCREEN	FREE	FREE, 4:3 SCREEN, 16:9 SCREEN, 16:10 SCREEN	
		WALL COLOR	OFF	OFF, WHITEBOARD, BLACKBOARD, BLACKBOARD (GRAY), LIGHT YELLOW, LIGHT GREEN, LIGHT BLUE, SKY BLUE, LIGHT ROSE, PINK	
		FAN MODE	AUTO	AUTO, NORMAL, HIGH, HIGH ALTITUDE	
		LIGHT MODE	LIGHT MODE	ECO1	NORMAL, ECO1, ECO2, LONG LIFE
			CONSTANT BRIGHTNESS	OFF	OFF, ON
			REF. LIGHT ADJUST		
		REF. WHITE BALANCE	CONTRAST R		
			CONTRAST G		
			CONTRAST B		
			BRIGHTNESS R		
			BRIGHTNESS G		
			BRIGHTNESS B		
		STATIC CONVERGENCE	UNIFORMITY R		
			UNIFORMITY B		
			HORIZONTAL R		
			HORIZONTAL G		
			HORIZONTAL B		
			VERTICAL R		
REF. LENS MEMORY	VERTICAL G				
	VERTICAL B				
	PROFILE	1	1, 2		
	STORE				
	MOVE				
	RESET				
LENS CALIBRATION	LOAD BY SIGNAL	OFF	OFF, ON		
	FORCED MUTE	OFF	OFF, ON		

5. Using On-Screen Menu

Menu Item				Default	Options			
SETUP	INSTALLATION(2)	SHUTTER SETTINGS		POWER ON SHUTTER	OPEN	OPEN, CLOSE		
				FADE IN TIME		0-10 SEC		
				FADE OUT TIME		0-10 SEC		
	CONTROL	ADMINISTRATOR MODE	MENU MODE		ADVANCED	ADVANCED, BASIC		
			NOT SAVE SETTING VALUES		OFF	OFF, ON		
			NEW PASSWORD					
			CONFIRM PASSWORD					
			PROGRAM TIMER	ENABLE		OFF	OFF, ON	
				SETTINGS	EDIT	ACTIVE	OFF	OFF, ON
						DAY	SUN	SUN, MON, TUE, WED, THU, FRI, SAT, MON-FRI, MON-SAT, EVERY DAY
						TIME		
						FUNCTION	POWER	POWER, INPUT, LIGHT MODE
					ADVANCED SETTINGS			
		POWER			OFF	OFF, ON		
		INPUT			HDMI1	HDMI1, HDMI2, DisplayPort, COMPUTER, HDBaseT		
		LIGHT MODE			ECO1	NORMAL, ECO1, ECO2, LONG LIFE		
		REPEAT		OFF	OFF, ON			
		DELETE						
		UP						
		DOWN						
		BACK						
		TOOLS	TIME ZONE SETTINGS	UTC		-12:00, -11:30, -11:00, -10:30, -10:00, -09:30, -09:00, -08:30, -08:00, -07:30, -07:00, -06:30, -06:00, -05:30, -05:00, -04:30, -04:00, -03:30, -03:00, -02:30, -02:00, -01:30, -01:00, -00:30, 00:00, +00:30, +01:00, +01:30, +02:00, +02:30, +03:00, +03:30, +04:00, +04:30, +05:00, +05:30, +06:00, +06:30, +07:00, +07:30, +08:00, +08:30, +09:00, +09:30, +10:00, +10:30, +11:00, +11:30, +12:00, +12:30, +13:00		
			DATE AND TIME SETTINGS	DATE MM/DD/YYYY				
					TIME HH:MM			
				INTERNET TIME SERVER		OFF, ON		
					IP ADDRESS			
			SUMMER TIME SETTINGS	ENABLE		OFF, ON		
				MON(START)		1, 2, 3, 4, 5, 6, 7, 8, 9, 10, 11, 12		
				DAY(START)		FIRST WEEK, SECOND WEEK, THIRD WEEK, FOURTH WEEK, LAST WEEK		
						SUN, MON, TUE, WED, THU, FRI, SAT		
				TIME(START)				
				MON(EXIT)		1, 2, 3, 4, 5, 6, 7, 8, 9, 10, 11, 12		
	DAY(EXIT)			FIRST WEEK, SECOND WEEK, THIRD WEEK, FOURTH WEEK, LAST WEEK				
				SUN, MON, TUE, WED, THU, FRI, SAT				
	TIME(EXIT)							
	TIME DIFFERENCE		+01:00, +00:30, -00:30, -01:00					
	MOUSE	BUTTON	RIGHT HAND	RIGHT HAND, LEFT HAND				
		SENSITIVITY	MEDIUM	FAST, MEDIUM, SLOW				
	CONTROL PANEL LOCK		OFF	OFF, ON				
	SECURITY		OFF	OFF, ON				
	COMMUNICATION SPEED		38400bps	4800bps, 9600bps, 19200bps, 38400bps, 115200bps				
CONTROL ID	CONTROL ID NUMBER	1	1-254					
	CONTROL ID	OFF	OFF, ON, AUTO					
REMOTE SENSOR		FRONT/BACK	FRONT/BACK, FRONT, BACK, HDBaseT					

5. Using On-Screen Menu

Menu Item		Default	Options		
SETUP	NETWORK SETTINGS	WIRED LAN	INTERFACE LAN, HDBaseT		
		PROFILES	DISABLE, PROFILE 1, PROFILE 2		
		DHCP	OFF, ON		
		IP ADDRESS			
		SUBNET MASK			
		GATEWAY			
		AUTO DNS	OFF, ON		
		DNS CONFIGURATION			
		RECONNECT			
		PROJECTOR NAME	PROJECTOR NAME	PJ-*****	
		DOMAIN	HOST NAME	pj-*****	
			DOMAIN NAME		
		ALERT MAIL	ALERT MAIL		OFF, ON
			HOST NAME		pj-*****
			DOMAIN NAME		
			SENDER'S ADDRESS		
			SMTP SERVER NAME		
			RECIPIENT'S ADDRESS 1		
			RECIPIENT'S ADDRESS 2		
	RECIPIENT'S ADDRESS 3				
	TEST MAIL				
	NETWORK SERVICE	HTTP SERVER	NEW PASSWORD		
			CONFIRM PASSWORD		
		PJLink	NEW PASSWORD		
			CONFIRM PASSWORD		
		AMX BEACON		OFF, ON	
		CRESTRON CONTROL	ROOMVIEW		
			ENABLE		
			IP ADDRESS		
			IP ID		
		Extron XTP		OFF, ON	
	SOURCE OPTIONS	AUTO ADJUST	NORMAL	OFF, NORMAL, FINE	
		AUDIO SELECT	HDMI1	HDMI1	HDMI1, COMPUTER
			HDMI2	HDMI2	HDMI2, COMPUTER
			DisplayPort	DisplayPort	DisplayPort, COMPUTER
			HDBaseT	HDBaseT	HDBaseT, COMPUTER
		DEFAULT INPUT SELECT	LAST	LAST, AUTO, HDMI1, HDMI2, DisplayPort, COMPUTER, HDBaseT	
		SEAMLESS SWITCHING	OFF	OFF, ON	
		BACKGROUND	BLUE	BLUE, BLACK, LOGO	
		HDBaseT OUT SELECT	AUTO	AUTO, HDMI1, HDMI2, DisplayPort, HDBaseT	
		EDID VERSION	HDMI1	MODE1	MODE1, MODE2
			HDMI2	MODE1	MODE1, MODE2
		HDCP VERSION	HDMI1	HDCP2.2	HDCP2.2, HDCP1.4
	HDMI2		HDCP2.2	HDCP2.2, HDCP1.4	
	HDBaseT		HDCP1.4	HDCP2.2, HDCP1.4	
POWER OPTIONS	STANDBY MODE	NORMAL	NORMAL, SLEEP		
	DIRECT POWER ON	OFF	OFF, ON		
	AUTO POWER ON SELECT	OFF	OFF, HDMI1, HDMI2, DisplayPort, COMPUTER, HDBaseT		
	AUTO POWER OFF	0:15	OFF, 0:05, 0:10, 0:15, 0:20, 0:30, 1:00		
	OFF TIMER	OFF	OFF, 0:30, 1:00, 2:00, 4:00, 8:00, 12:00, 16:00		
RESET	CURRENT SIGNAL				
	ALL DATA ALL DATA (INCLUDING ENTRY LIST)				

5. Using On-Screen Menu

Menu Item		Default	Options	
INFO.	USAGE TIME	LIGHT HOURS USED		
		TOTAL CARBON SAVINGS		
	SOURCE(1)	INPUT TERMINAL		
		RESOLUTION		
		HORIZONTAL FREQUENCY		
		VERTICAL FREQUENCY		
		SYNC TYPE		
		SYNC POLARITY		
		SCAN TYPE		
		SOURCE NAME		
	SOURCE(2)	ENTRY NO.		
		SIGNAL TYPE		
		BIT DEPTH		
		VIDEO LEVEL		
	SOURCE(3)	SAMPLING FREQUENCY		
		3D FORMAT		
		INPUT TERMINAL		
		RESOLUTION		
		HORIZONTAL FREQUENCY		
		VERTICAL FREQUENCY		
		SYNC TYPE		
		SYNC POLARITY		
	SOURCE(4)	SCAN TYPE		
		SOURCE NAME		
		ENTRY NO.		
		SIGNAL TYPE		
	WIRED LAN	BIT DEPTH		
		VIDEO LEVEL		
		SAMPLING FREQUENCY		
		3D FORMAT		
	VERSION(1)	IP ADDRESS		
		SUBNET MASK		
		GATEWAY		
		MAC ADDRESS		
	OTHERS	FIRMWARE		
		DATA		
		FIRMWARE2		
		DATE TIME		
		PROJECTOR NAME		
		MODEL NO.		
	CONDITIONS	SERIAL NUMBER		
		CONTROL ID*5		
		DETECTED PROJECTORS		
		LENS ID		
		INTAKE TEMPERATURE		
		EXHAUST TEMPERATURE		
	HDBaseT	ATMOSPHERIC PRESSURE		
INSTALLATION POSITION				
X-AXIS				
Y-AXIS				
HDBaseT	Z-AXIS			
	SIGNAL QUALITY			
	OPERATION MODE			
HDBaseT	LINK STATUS			
	HDMI STATUS			

*5 [CONTROL ID] will be displayed when [CONTROL ID] has been set up.

4 Menu Descriptions & Functions [INPUT]

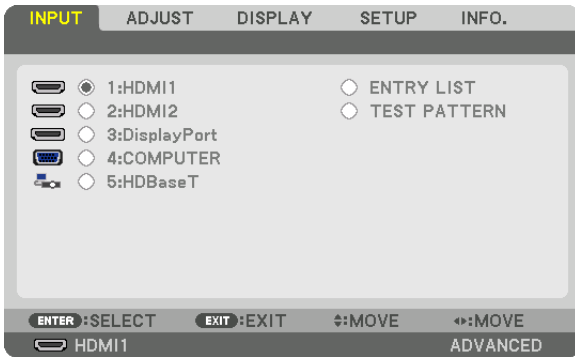

1:HDMI1

This projects the video of the device connected to the HDMI 1 IN terminal.

2:HDMI2

This projects the video of the device connected to the HDMI 2 IN terminal.

3:DisplayPort

This projects the video of the device connected to the DisplayPort IN terminal.

4:COMPUTER

This projects the video of the device connected to the computer video input terminal.
(This projects the analog RGB signal or component signal.)

5:HDBaseT

Projecting the HDBaseT signal.

ENTRY LIST

Displays a list of signals. See the following pages.

TEST PATTERN

Closes the menu and switches to the test pattern screen.

Using the Entry List

When any source adjustments are made, the adjustments are automatically registered in the Entry List. The (adjustment values of) registered signals can be loaded from the Entry List whenever necessary. However, only up to 100 patterns can be registered in the Entry List. When 100 patterns have been registered in the Entry List, an error message is then displayed and no additional patterns can be registered. You should thus delete (adjustment values of) signals that are no longer needed.

Displaying the Entry list

1. Press the MENU button.

The menu will be displayed.

2. Press the ◀ or ▶ button to select [INPUT].

The INPUT list will be displayed.

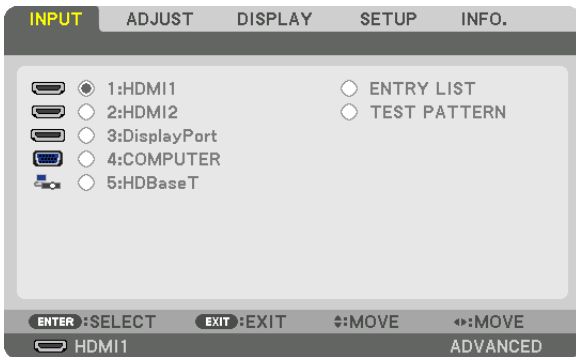

* This screen belongs to a HDBaseT model.

3. Use the ◀, ▶, ▲, or ▼ to select [ENTRY LIST] and press the ENTER button.

The ENTRY LIST windows will be displayed.

If the ENTRY LIST window is not displayed, switch the menu to [ADVANCED].

To switch the menu between [ADVANCED] and [BASIC], select [SETUP] → [CONTROL] → [TOOLS] → [ADMINISTRATOR MODE] → [MENU MODE]. (→ page 116)

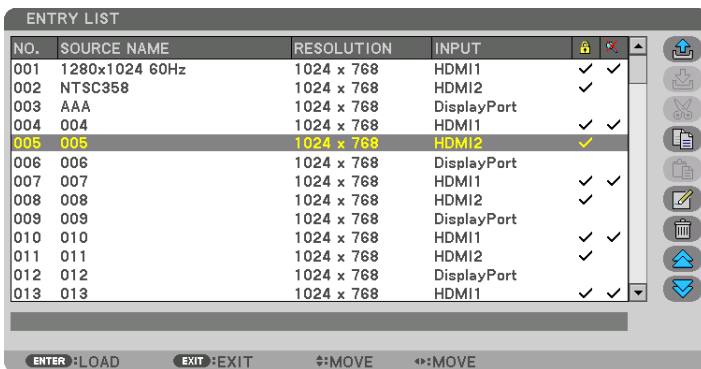

Entering the currently projected signal into the Entry List [ (STORE)]

1. Press the ▲ or ▼ button to select any number.
2. Press the ◀ or ▶ button to select [ (STORE)] and press the ENTER button.

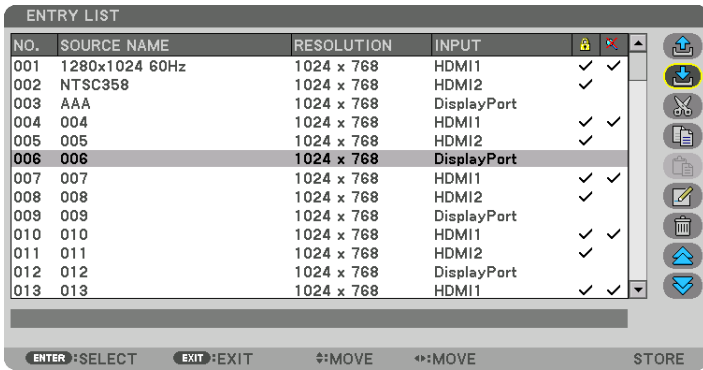

Calling up a signal from the Entry List [ (LOAD)]



Press the ▲ or ▼ button to select a signal and press the ENTER button.

Editing a signal from the Entry List [ (EDIT)]

1. Press the ▲ or ▼ button to select a signal you wish to edit.
2. Press the ◀, ▶, ▲, or ▼ button to select [ (EDIT)] and press the ENTER button.

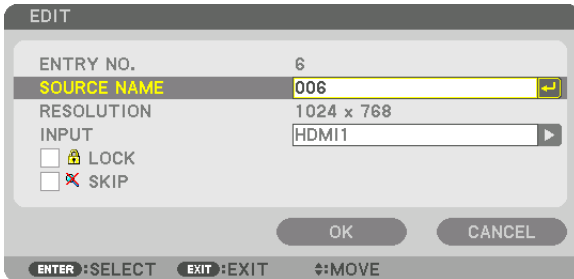
The EDIT window will be displayed.



SOURCE NAME	Enter a signal name. Up to 18 alphanumeric characters can be used.
INPUT	The input terminal can be changed. Switching between HDMI/DisplayPort/Computer/HDBaseT is possible.
 LOCK	Set so that the selected signal cannot be deleted when [ (ALL DELETE)] is executed. The changes made after LOCK execution cannot be saved.
 SKIP	Set so that the selected signal will be skipped during auto search.

3. Set the above items and select [OK] and press the ENTER button.

NOTE: The input terminal cannot be changed to the currently projected signal.

Cutting a signal from the Entry List [(CUT)]

1. Press the ▲ or ▼ button to select a signal you wish to delete.
2. Press the ◀, ▶, ▲, or ▼ button to select [ (CUT)] and press the ENTER button.

The signal will be deleted from the Entry List and the deleted signal will be displayed on the clipboard at the bottom of the Entry List.



NOTE:

- The currently projected signal cannot be deleted.
- When the locked signal is selected, it will be displayed in gray which indicates it is not available.

TIP:

- Data on the clipboard can be passed onto the Entry List.
- Data on the clipboard will not be lost after the Entry List is closed.

Copying and pasting a signal from the Entry List [(COPY)] / [(PASTE)]

1. Press the ▲ or ▼ button to select a signal you wish to copy.
2. Press the ◀, ▶, ▲, or ▼ button to select [ (COPY)] and press the ENTER button.
The copied signal will be displayed on the clipboard at the bottom of the Entry List.
3. Press the ◀ or ▶ button to move to the list.
4. Press the ▲ or ▼ button to select a signal.
5. Press the ◀, ▶, ▲, or ▼ button to select [ (PASTE)] and press the ENTER button.

Data on the clipboard will be pasted to the signal.

Deleting all the signals from the Entry List [(ALL DELTE)]

1. Press the ◀, ▶, ▲, or ▼ button to select [ (ALL DELETE)] and press the ENTER button.
The confirmation message will be displayed.
2. Press the ◀ or ▶ button to select [YES] and press the ENTER button.

NOTE: The locked signal cannot be deleted.

Using Test Pattern [TEST PATTERN]

Displays the test pattern for adjusting distortion on the screen and the focus at the time of the projector setup. Once the [TEST PATTERN] on the onscreen menu is selected, the pattern for adjustment will be displayed on. If you find distortion on the pattern, adjust the projector installation angle or correct distortion by pressing the Geometric. button on the remote. If the focus adjustment is required, press the FOCUS button on the remote control for displaying the FOCUS adjustment screen and then adjust FOCUS by ◀ or ▶ button. Recommend to perform the focus adjustment after leaving the projector under the state the TEST PATTERN has been projected for over 30 minutes. Press EXIT button to close the test pattern and return to the menu.

5 Menu Descriptions & Functions [ADJUST] [PICTURE]

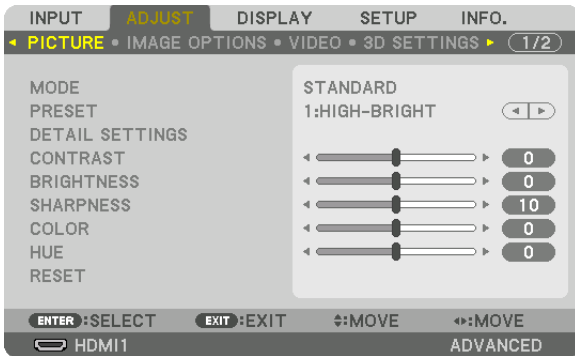

[MODE]

This function allows you to determine how to save settings for [DETAIL SETTINGS] of [PRESET] for each input.

- STANDARD Saves settings for each item of [PRESET] (Preset 1 through 7)
- PROFESSIONAL..... Saves all the settings of [PICTURE] for each input.

NOTE:

- When [TEST PATTERN] is displayed, [MODE] cannot be selected.

[PRESET]

This function allows you to select optimized settings for your projected image. You can adjust neutral tint for yellow, cyan or magenta.

There are seven factory presets optimized for various types of images. You can also use [DETAIL SETTINGS] to set user adjustable settings to customize each gamma or color.

Your settings can be stored in [PRESET 1] to [PRESET 7].

- AUTO Automatically distinguish the optimal setting for the input signal.
- HIGH-BRIGHT Recommended for use in a brightly lit room.
- PRESENTATION Recommended for making a presentation using a PowerPoint file.
- VIDEO Recommended for typical TV program viewing.
- MOVIE Recommended for movies.
- GRAPHIC Recommended for graphics.
- sRGB Standard color values
- DICOM SIM. Recommended for DICOM simulation format.

NOTE:

- The [DICOM SIM.] option is for training/reference only and should not be used for actual diagnosis.
- DICOM stands for Digital Imaging and Communications in Medicine. It is a standard developed by the American College of Radiology (ACR) and the National Electrical Manufacturers Association (NEMA).
The standard specifies how digital image data can be moved from system to system.

[DETAIL SETTINGS]

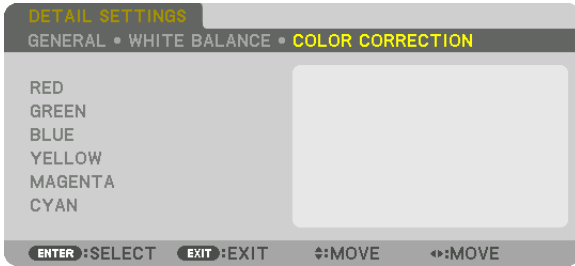
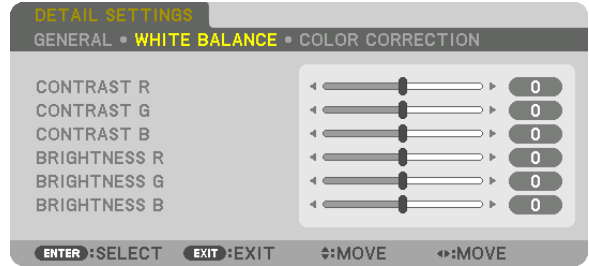
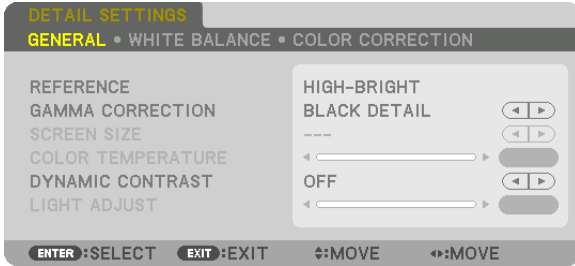

[GENERAL]

Storing Your Customized Settings [REFERENCE]

This function allows you to store your customized settings in [PRESET 1] to [PRESET 7]. First, select a base preset mode from [REFERENCE], then set [GAMMA CORRECTION] and [COLOR TEMPERATURE].

- HIGH-BRIGHT Recommended for use in a brightly lit room.
- PRESENTATION Recommended for making a presentation using a PowerPoint file.
- VIDEO Recommended for typical TV program viewing.
- MOVIE Recommended for movies.
- GRAPHIC Recommended for graphics.
- sRGB Standard color values.
- DICOM SIM. Recommended for DICOM simulation format.

Selecting Gamma Correction Mode [GAMMA CORRECTION]

- Each mode is recommended for:
- DYNAMIC Creates a high-contrast picture.
 - NATURAL Natural reproduction of the picture.
 - BLACK DETAIL Emphasizes detail in dark areas of the picture.

NOTE: This function is not available when [DICOM SIM.] is selected for [DETAIL SETTINGS].

Selecting Screen Size for DICOM SIM [SCREEN SIZE]

- This function will perform gamma correction appropriate for the screen size.
- LARGE For screen size of 150"
 - MEDIUM For screen size of 100"
 - SMALL For screen size of 50"

NOTE: This function is available only when [DICOM SIM.] is selected for [DETAIL SETTINGS].

Adjusting Color Temperature [COLOR TEMPERATURE]

This option allows you to select the color temperature of your choice. A value between 5000 K and 10500 K can be set in 100 K units.

NOTE: When [HIGH-BRIGHT] is selected in [REFERENCE], this function is not available.

Adjusting Brightness and Contrast [DYNAMIC CONTRAST]

When set, the most optimal contrast ratio is adjusted according to the video.

- OFF Dynamic contrast is disabled.
- MOTION IMAGE..... Most optimal settings for moving images.
- STILL IMAGE..... Most optimal settings for static images. Rapidly follows any changes in the video.

NOTE:

- Depending on the conditions, projector settings such as [DYNAMIC CONTRAST] may not be able to be selected.
-

Adjusting Brightness [LIGHT ADJUST]

The adjustment is effective when [PROFESSIONAL] is selected for [MODE].

Adjusting White Balance [WHITE BALANCE]

This allows you to adjust the white balance. Contrast for each color (RGB) to adjust the white level of the screen; Brightness for each color (RGB) is used to adjust the black level of the screen.

[COLOR CORRECTION]

Corrects the color for all signals.
Adjusts the tone for the colors red, green, blue, yellow, magenta and cyan.

RED	HUE	+ Direction	Magenta direction
		- Direction	Yellow direction
	SATURATION	+ Direction	Vivid
		- Direction	Weak
GREEN	HUE	+ Direction	Yellow direction
		- Direction	Cyan direction
	SATURATION	+ Direction	Vivid
		- Direction	Weak
BLUE	HUE	+ Direction	Cyan direction
		- Direction	Magenta direction
	SATURATION	+ Direction	Vivid
		- Direction	Weak
YELLOW	HUE	+ Direction	Red direction
		- Direction	Green direction
	SATURATION	+ Direction	Vivid
		- Direction	Weak
MAGENTA	HUE	+ Direction	Blue direction
		- Direction	Red direction
	SATURATION	+ Direction	Vivid
		- Direction	Weak
CYAN	HUE	+ Direction	Green direction
		- Direction	Blue direction
	SATURATION	+ Direction	Vivid
		- Direction	Weak

[CONTRAST]

Adjusts the intensity of the image according to the incoming signal.

[BRIGHTNESS]

Adjusts the brightness level or the back raster intensity.

[SHARPNESS]

Controls the detail of the image.

[COLOR]

Increases or decreases the color saturation level.

[HUE]

Varies the color level from +/- green to +/- blue. The red level is used as reference.

NOTE:

- *When [TEST PATTERN] is displayed, [CONTRAST], [BRIGHTNESS], [SHARPNESS], [COLOR] and [HUE] cannot be adjusted.*
-

[RESET]

The settings and adjustments for [PICTURE] will be returned to the factory default settings with the exception of the following; Preset numbers and [REFERENCE] within the [PRESET] screen.

The settings and adjustments under [DETAIL SETTINGS] within the [PRESET] screen that are not currently selected will not be reset.

[IMAGE OPTIONS]

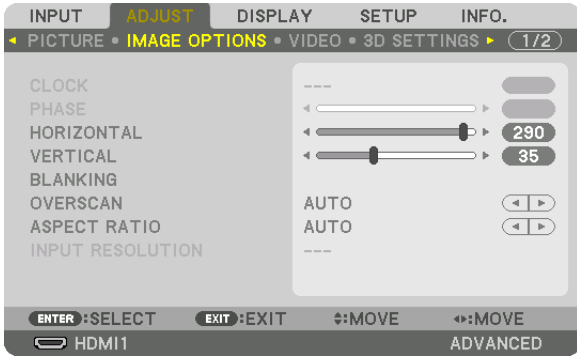

Adjusting Clock and Phase [CLOCK/PHASE]

This allows you to manually adjust CLOCK and PHASE.

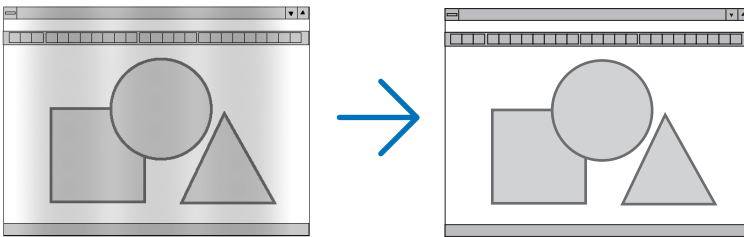

CLOCK..... Use this item to fine tune the computer image or to remove any vertical banding that might appear. This function adjusts the clock frequencies that eliminate the horizontal banding in the image. This adjustment may be necessary when you connect your computer for the first time.

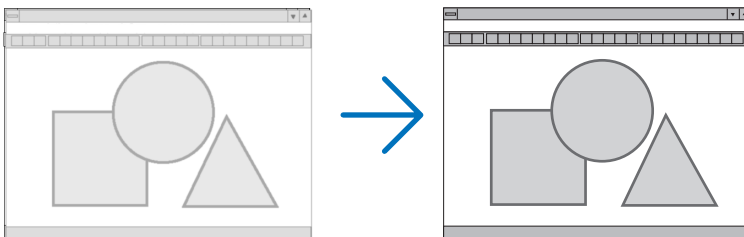

PHASE..... Use this item to adjust the clock phase or to reduce video noise, dot interference or cross talk. (This is evident when part of your image appears to be shimmering.) Use [PHASE] only after the [CLOCK] is complete.

NOTE: The [CLOCK] and [PHASE] items are available for RGB signals only.

Adjusting Horizontal/Vertical Position [HORIZONTAL/VERTICAL]

Adjusts the image location horizontally and vertically.

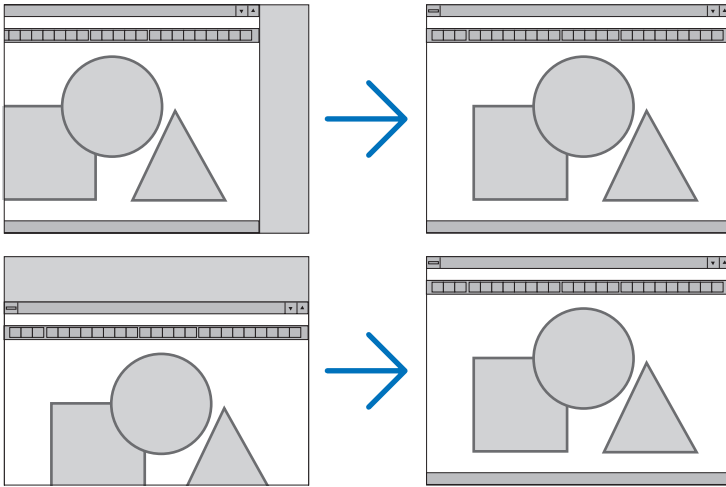

- An image can be distorted during the adjustment of [CLOCK] and [PHASE]. This is not malfunction.
- The adjustments for [CLOCK], [PHASE], [HORIZONTAL], and [VERTICAL] will be stored in memory for the current signal. The next time you project the signal with the same resolution, horizontal and vertical frequency, its adjustments will be called up and applied.

To delete adjustments stored in memory, from the menu, you select [SETUP] → [RESET] → [CURRENT SIGNAL] and reset the adjustments.

[BLANKING]

Adjusts the display range (blanking) at the top, bottom, left and right edges of the input signal.

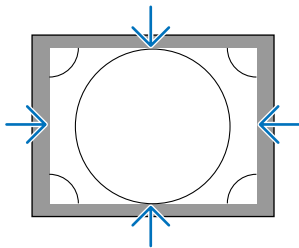

Selecting Overscan Percentage [OVERSCAN]

Select overscan percentage (Auto, 0%, 5% and 10%) for signal.

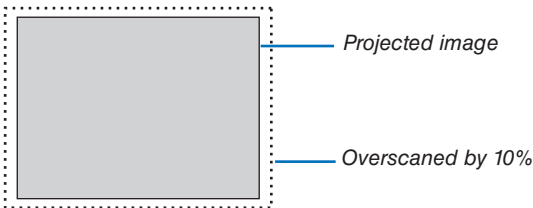

NOTE:

- The [OVERSCAN] item is not available:
 - when [NATIVE] is selected for [ASPECT RATIO].

Selecting the Aspect Ratio [ASPECT RATIO]

Use this function to select the screen's lateral:longitudinal aspect ratio. The projector automatically identifies the signal being input and sets the optimum aspect ratio.

For Computer signal

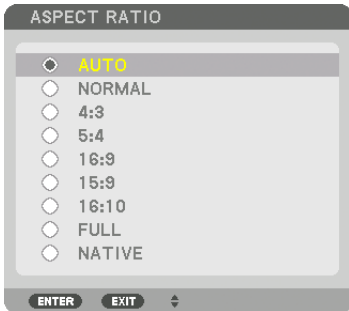

For HDTV/SDTV signals

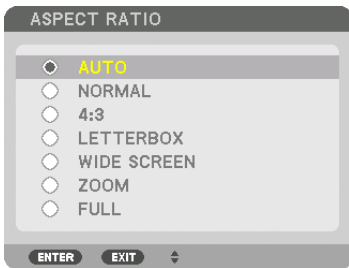

	Resolution	Aspect Ratio
VGA	640 × 480	4:3
SVGA	800 × 600	4:3
XGA	1024 × 768	4:3
WXGA	1280 × 768	15:9
WXGA	1280 × 800	16:10
HD(FWXGA)	1366 × 768	approx. 16:9
WXGA+	1440 × 900	16:10
SXGA	1280 × 1024	5:4
SXGA+	1400 × 1050	4:3
WXGA++	1600 × 900	16:9
UXGA	1600 × 1200	4:3
WSXGA+	1680 × 1050	16:10
FHD(1080P)	1920 × 1080	16:9
WUXGA	1920 × 1200	16:10
WQXGA	2560 × 1600	16:10
Quad HD	3840 × 2160	16:9
Quad HD	4096 × 2160	19:7

Options	Function
AUTO	The projector will automatically determine the incoming signal and display it in its aspect ratio. The projector may erroneously determine the aspect ratio depending on its signal. If this occurs, select the appropriate aspect ratio from the following.
NORMAL	The image is displayed in its original aspect ratio of its input signal..
4:3	The image is displayed in 4:3 aspect ratio.
5:4	The image is displayed in 5:4 aspect ratio
16:9	The image is displayed in 16:9 aspect ratio

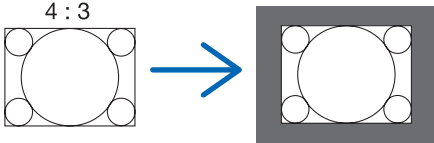
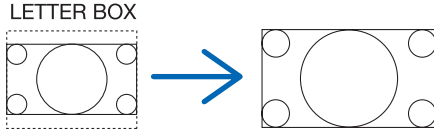
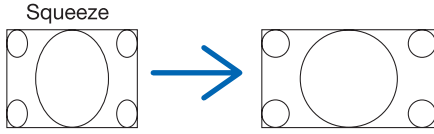
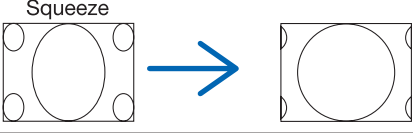
Options	Function
15:9	The image is displayed in 15:9 aspect ratio
16:10	The image is displayed in 16:10 aspect ratio
NATIVE	<p>The projector displays the current image in its true resolution when the incoming computer signal has a lower or higher resolution than the projector's native resolution. (→ page 2)</p> <p>When the incoming computer signal has a higher resolution than the projector's native resolution, the center of an image will be displayed.</p> 
LETTER BOX	<p>The image of a letterbox signal (16:9) is stretched equally in the horizontal and vertical directions to fit the screen.</p> 
WIDE SCREEN	<p>The image of a squeeze signal (16:9) is stretched left and right in 16:9.</p> 
ZOOM	<p>The image of a squeeze signal (16:9) is stretched left and right in 4:3. Parts of the displayed image are cropped at the left and right edges and therefore not visible.</p> 
FULL	Project to full screen size.

TIP:

- Image position can be adjusted vertically using [POSITION] when the [16:9], [15:9], or [16:10] aspect ratios are selected.
- The term "letterbox" refers to a more landscape-oriented image when compared to a 4:3 image, which is the standard aspect ratio for a vide source.
The letterbox signal has aspect ratios with the vista size "1.85:1" or cinema scope size "2.35:1" for movie film.
- The term "squeeze" refers to the compressed image of which aspect ratio is converted from 16:9 to 4:3.

[INPUT RESOLUTION]

The resolution is assigned automatically when the resolution of the input signal from the computer video input terminal (analog RGB) cannot be distinguished.

[VIDEO]

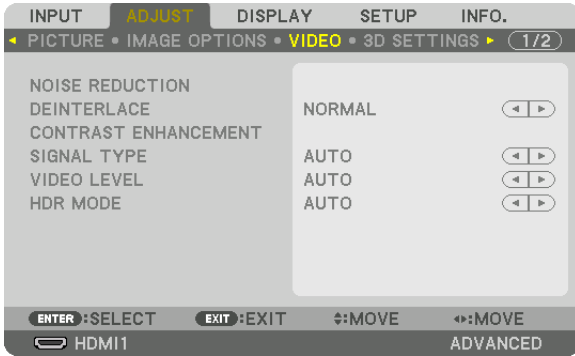

Using Noise Reduction [NOISE REDUCTION]

When projecting a video image, you can use the [NOISE REDUCTION] function to reduce the screen noise (roughness and distortion). This device is equipped with three types of noise reduction functions. Select the function according to the type of noise. Depending on the noise level, the noise reduction effect can be set to [OFF], [LOW], [MEDIUM] or [HIGH]. [NOISE REDUCTION] can be selected for SDTV, HDTV signal and component signal input.

- RANDOM NR Reduces flickering random noise in an image.
- MOSQUITO NR Reduces mosquito noise that appears around the edges of an image during Blu-ray playback.
- BLOCK NR Reduces block noise or mosaic-like patterns.

Selecting Interlaced Progressive Conversion Process Mode [DEINTERLACE]

This function allows you to select an interlaced-to-progressive conversion process for video signals.

- NORMAL..... Automatically distinguishes a moving image from a static image to create a distinct image. Please select [MOVIE] if there are any obvious jitter and noises.
- MOVIE Select when projecting moving images. This is suitable for signals with a lot of jitter and noise.
- STILL..... Select when projecting static images. The video will flicker when a moving image is projected.

[CONTRAST ENHANCEMENT]

Using the characteristics of the human eye, a picture quality with a sense of contrast and resolution is achieved.

- OFF Suite vision is switched off.
- AUTO Contrast and picture quality are automatically improved using the suite vision function.
- NORMAL..... Adjust the gain manually.

[SIGNAL TYPE]

Selection of RGB and component signals. Normally, this is set to [AUTO]. Please change the setting if the color of the image remains unnatural.

- AUTO Automatically distinguishes RGB and component signals.
- RGB Switches to the RGB input.
- REC601 Switches to the component signal conforming to the ITU-R Rec601 standard.
Setting appropriate to SDTV images.
- REC709 Switches to the component signal conforming to the ITU-R Rec709 standard.
Setting appropriate to Hi-Vision images.
- REC2020 Switches to the component signal conforming to the ITU-R Rec2020 standard.
Setting appropriate to 4K images.

[VIDEO LEVEL]

Selection of the video signal level when connecting an external device to the HDMI 1 IN terminal, HDMI 2 IN terminal, DisplayPort input terminal, and HDBaseT IN terminal of the projector.

- AUTO The video level is switched automatically based on the information from the device outputting the signal.
Depending on the connected device, this setting may not be made properly. In this case, switch to [NORMAL] or [ENHANCED] from the menu and view with the optimum setting.
- NORMAL This disables the enhanced mode.
- ENHANCED This improves the image's contrast, expressing the dark and light sections more dynamically.
- SUPER WHITE The video contrast is improved and the dark areas appear more dynamic.

[HDR MODE]

- AUTO Automatically distinguishes HDR signal.
- OFF Projects the image based on the input signal
- ON Projects the image conforming to the HDR signal

Note: These options are available exclusively for 4K signal.

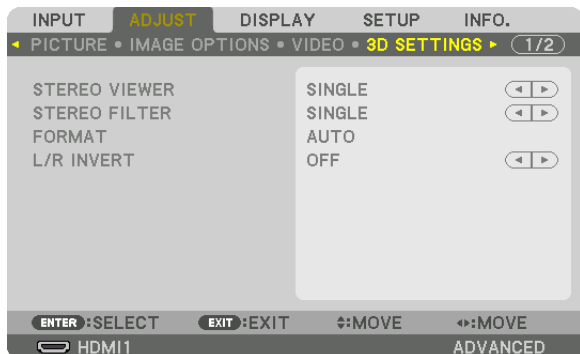
[3D SETTINGS]

Please refer to “3-10 Projecting 3D videos” (→ page 44) for the operation.

STEREO VIEWER

Stack up a single or multiple projectors and carry out the settings for projecting 3D videos. Select the left / right settings of the 3D eyewear using the stereo viewer.

- SINGLE Use a single projector to project 3D videos.
- DUAL LEFT Use a dedicated projector for displaying videos on the left.
- DUAL RIGHT Use a dedicated projector for displaying videos on the right.

STEREO FILTER

Stack up a single or multiple projectors and carry out the settings for projecting 3D videos. Image setting for 3D glasses made by Infitec.

- SINGLE Use a single projector to project 3D videos.
- DUAL LEFT Use a dedicated projector for displaying videos on the left.
- DUAL RIGHT Use a dedicated projector for displaying videos on the right.

FORMAT

Select the 3D video format (recording / transmission format). Select to match the 3D broadcast and 3D media. Normally, [AUTO] is selected. Please select the 3D input signal format when the 3D detection signal of the format cannot be distinguished.

L/R INVERT

Invert the display order of the left and right videos.
Select [ON] if you feel uncomfortable with the 3D display when [OFF] is selected.

Using the Lens Memory Function [LENS MEMORY]



This function serves to store the adjusted values for each input signal when using the LENS SHIFT, ZOOM and FOCUS buttons of the projector. Adjusted values can be applied to the signal you selected. This will eliminate the need to adjust lens shift, focus, and zoom at the time of source selection.

- STORE Stores the current adjusted values in memory for each input signal.
- MOVE Applies the adjusted values to the current signal.
- RESET..... Returns the adjusted values to the last condition.

NOTE:

- Lens memory adjustments will be automatically registered the ENTRY LIST. These lens memory adjustments can be loaded from the ENTRY LIST. (→ page 83)
Note that performing [CUT] or [ALL DELETE] in the ENTRY LIST will delete lens memory adjustments as well as source adjustments. This deletion will not take effect until other adjustments is loaded.
- For storing each adjustment of lens shift, zoom and focus as common value for all input signal, store them as reference lens memory.

To store your adjusted values in [LENS MEMORY]:

1. **Project the connected device signal you want to adjust.**
2. **Adjust the projecting image of position, size and focus by the SHIFT/HOME POSITION, ZOOM +/-, and FOCUS +/- buttons.**
 - Adjustment can be performed by the remote control. Please refer to “2-5 Adjusting the Picture Size and Position” on page 20.
 - Slight adjustment by moving the projector position and by the tilt foot is not subject of [LENS MEMORY].
3. **Move the cursor on [STORE] and press ENTER.**

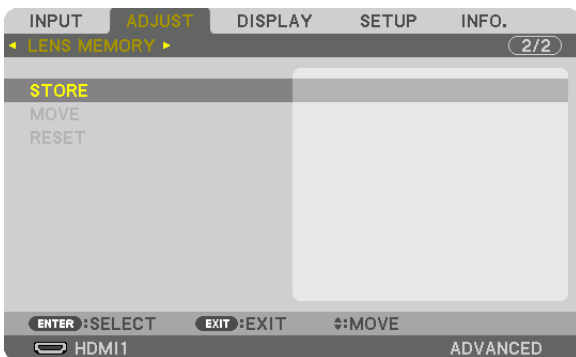

4. **Move the cursor on [YES] and press ENTER.**

To call up the adjusted values from [LENS MEMORY]:

1. From the menu, select [ADJUST] → [LENS MEMORY] → [MOVE] and press the ENTER button.

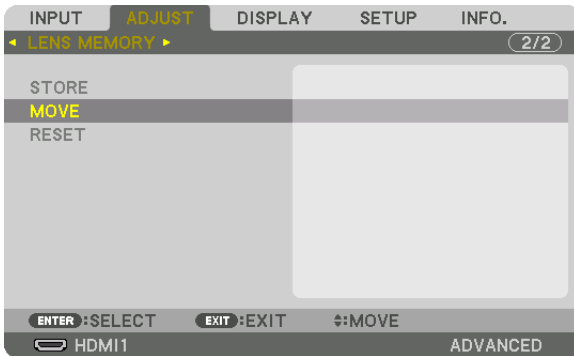

The confirmation screen will be displayed.

2. Press the ◀ button to select and [YES] and press the ENTER button.

During projection, if the adjusted values for an input signal have been saved, the lens will shift. If not, the lens will shift according to the adjusted values stored in the selected [REF. LENS MEMORY] [PROFILE] number.

To automatically apply the adjusted values at the time of source selection:

1. From the menu, select [SETUP] → [INSTALLATION(1)] → [REF. LENS MEMORY] → [LOAD BY SIGNAL] and press the ENTER button.



2. Press the ▼ button to select and [ON] and press the ENTER button.

This will move the lens automatically to the position at the time of source selection according to the adjusted values.

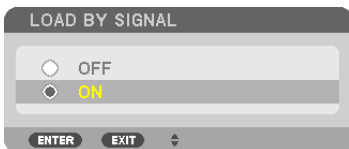

NOTE:

- The Lens Memory function may not produce a completely aligned image (due to tolerances in the lenses) using the adjusted values stored in the projector. After calling up and applying the adjusted values from the Lens Memory function, finely adjust the lens shift, zoom and focus to produce the best possible image.

⑥ Menu Descriptions & Functions [DISPLAY] [PIP/PICTURE BY PICTURE]

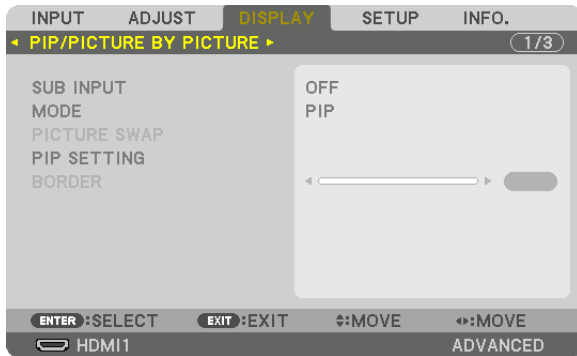

SUB INPUT

Select the input signal to be displayed in the sub-display.

Please refer to “4-2 Displaying Two Pictures at the Same Time” (→ page 64) for details on the operation.

MODE

Select either PIP (PICTURE IN PICTURE) or PICTURE BY PICTURE when switching to 2-screen display.

PICTURE SWAP

The videos in the main display and sub-display will be switched.

Please refer to “4-2 Displaying Two Pictures at the Same Time” (→ page 64) for details.

PIP SETTING

Select the display position, position adjustment and size of the sub-display in the PIP screen.

START POSITION... Selection of the display position of the sub-display when switching to the PIP screen.

HORIZONTAL POSITION

..... Adjust the display position of the sub-display in the horizontal direction. The respective corners will serve as reference points.

VERTICAL POSITION

..... Adjust the display position of the sub-display in the vertical direction. The respective corners will serve as reference points.

SIZE..... Select the display size of the sub-display.

TIP:

The horizontal position and vertical position are the amount of movement from the reference points. For example, when TOP-LEFT is adjusted, the position is displayed with the same amount of movement even if displayed with other starting positions. The maximum amount of movement is half the resolution of the projector.

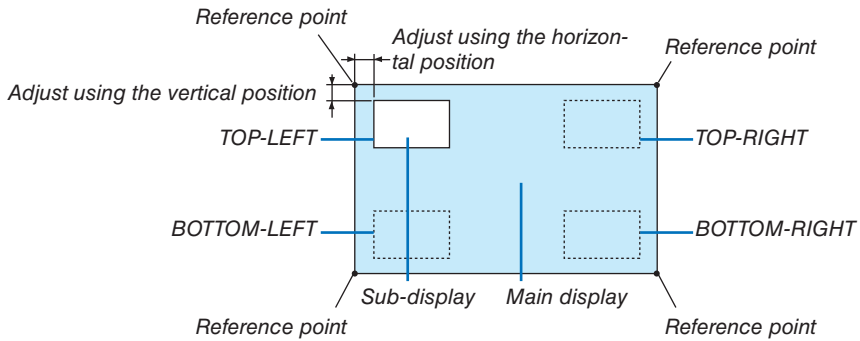

BORDER

Select the display boundary of the main display and sub-display of the [PICTURE BY PICTURE] screen.

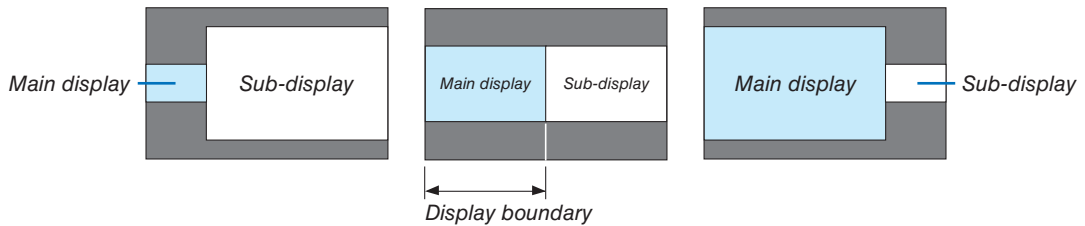

TIP:

- Seven options from zero to six are available.

[GEOMETRIC CORRECTION]

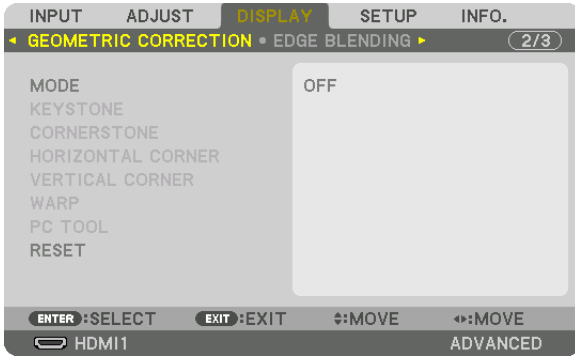

MODE

Set pattern for correcting distortion. If [OFF] is selected, the [GEOMETRIC CORRECTION] becomes ineffective. If you need to change the [MENU ANGLE], make sure to change it before performing the [GEOMETRIC CORRECTION]. If [MENU ANGLE] is changed after performing the [GEOMETRIC CORRECTION], corrected values will be reset to the default values.

KEYSTONE

Correct distortion in horizontal and vertical directions.

HORIZONTAL..... Adjustments when projecting from a diagonal direction to the screen.

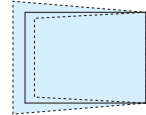

VERTICAL Adjustments when projecting from the top or bottom direction to the screen.



TILT Adjusts the distortion when performing trapezoidal correction with the screen moved in the vertical direction using the lens shift.

THROW RATIO..... Adjusts according to the projection ratio of the optional lens used.

Model name of lens unit	Adjustment range
NP40ZL	8-11
NP41ZL	13-30
NP42ZL	30-60

NOTE:

- When power is supplied to the device, the adjustment value of the [KEYSTONE] used previously is retained even if the gradient of the device is changed.
- As electrical correction is carried out by [KEYSTONE], the brightness may be reduced or the screen quality may deteriorate sometimes.

CORNERSTONE

Display the 4-point correction screen and adjust the trapezoidal distortion of the projection screen. Please refer to "Correcting Horizontal and Vertical Keystone Distortion [CORNERSTONE]" (→ page 36) for details on the operation.

HORIZONTAL CORNER/VERTICAL CORNER

Distortion correction for corner projection such as wall surfaces.

HORIZONTAL CORNER

..... Performs correction for projection onto a wall lying at an angle to the horizontal direction.

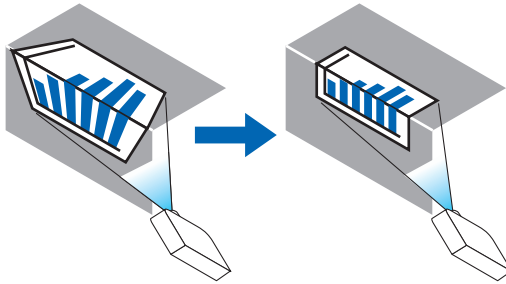

* Reverse angle correction is also possible.

VERTICAL CORNER

..... Performs correction for projection onto a wall lying at an angle to the vertical direction.

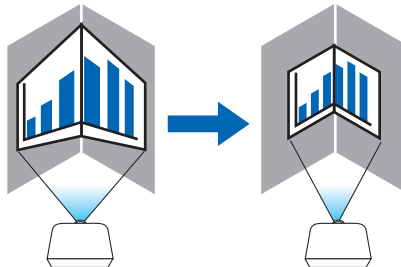

* Reverse angle correction is also possible.

NOTE:

- When the maximum adjustment range is exceeded, distortion adjustment is disabled. Set up the projector at an optimal angle as the deterioration in the image quality increases as the distortion adjustment volume gets larger.
 - Please note that the image will go out of focus due to the difference in the distance between the upper and lower or left and right sides and the center of the screen for projections cutting across corners. Lenses with short focal points are also not recommended for projections cutting across corners as the image will go out of focus.
-

Adjustment method

1. Align the cursor with the [HORIZONTAL CORNER] or [VERTICAL CORNER] of the [GEOMETRIC CORRECTION] menu and then press the ENTER button.
 - The adjustment screen will be displayed.
2. Press the ▼▲◀▶ buttons to align the cursor (yellow box) with the target adjustment point and then press the ENTER button.
 - The cursor will change into an adjustment point (yellow in color).
3. Press the ▼▲◀▶ buttons to adjust the corners or sides of the screen and then press the ENTER button.
 - The adjustment point will go back to being a cursor (yellow box).

Explanation of screen transition

- The adjustment points of the four corners (a, c, f and h in the drawing) will move independently.
- The following adjustment points differ at the [HORIZONTAL CORNER] and [VERTICAL CORNER].
 HORIZONTAL CORNER: When Point b in the drawing is moved, and the upper side and Point g are moved, the lower side will move in a parallel manner.
 VERTICAL CORNER: When Point d in the drawing is moved, and the left side and Point e are moved, the right side will move in a parallel manner.

[Adjustment points of the [HORIZONTAL CORNER] screen and movement points of the projection screen]

Point b will be displaced in a parallel manner at the same time as Points a, b, c

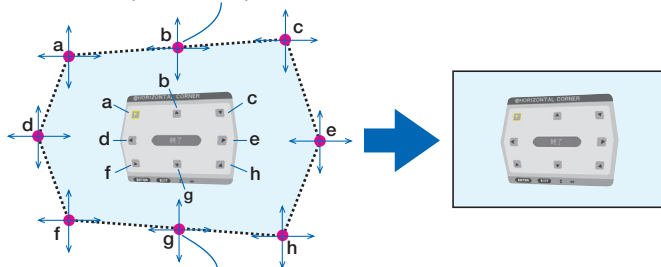

Point g will be displaced in a parallel manner at the same time as Points f, g, h

[Adjustment points of the [VERTICAL CORNER] screen and movement points of the projection screen]

Point d will be displaced in a parallel manner at the same time as Points a, d, f

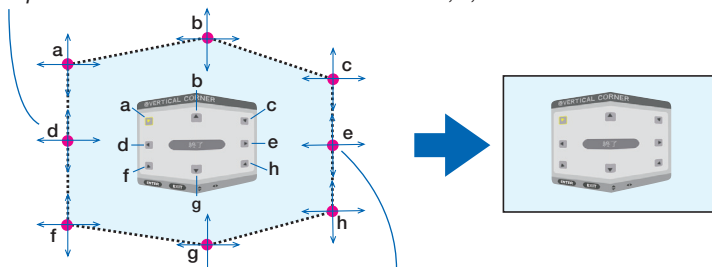

Point e will be displaced in a parallel manner at the same time as Points f, g, h

4. Start from Step 2 onwards to adjust the other points.
5. When the adjustment is completed, press the ▼▲◀▶ buttons to align the cursor with the [EXIT] in the adjustment screen and then press the ENTER button.
 - Switch to the [GEOMETRIC CORRECTION] menu screen.

TIP:

A commercially available USB mouse is available to perform correction. (→ page 38)

WARP

Correct projected image distortion on a specific surface as a column or a sphere.

NOTE:

- When the maximum adjustment range is exceeded, distortion adjustment is disabled. Set up the projector at an optimal angle since the more the adjustment volume gets large, the more image quality gets deterioration.
- Please note that the image will go out of focus due to the difference in the distance between peripheries and the center of the screen for projections cutting across corners as on a column or a sphere. Lenses with short focal points are also not recommended for projections cutting across corners as the image will go out of focus.

Adjustment method

1. **Align the cursor with the [WARP] of the [GEOMETRIC CORRECTION] menu and then press the ENTER.**
 - Adjustment screen will be displayed on.
2. **Press the ▼▲◀▶ buttons to align the cursor (blue box) with the target adjustment point and then press the ENTER.**
 - The cursor will change into an adjustment point (yellow in color).
3. **Press the ▼▲◀▶ buttons to adjust the corners or sides of the screen and then press the ENTER.**
 - The cursor will back to yellow box.

Explanation for correcting distortion

- Eight adjustment points can be moved independently.
- For left and right sides, use ◀▶ buttons for adjusting the range of distortion, and ▼/▲ buttons for adjusting the distortion peak.
- For top and bottom sides, use ▼/▲ buttons for adjusting the range of distortion, and ◀▶ buttons for adjusting the distortion peak.
- For corners, use ▼▲◀▶ buttons for moving positions.

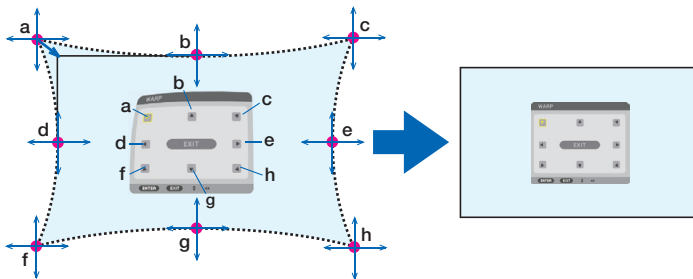

4. **For adjusting other points, repeat Step2 onwards.**
5. **When the adjustment is completed, move the cursor onto the [EXIT] on the adjustment screen and press the ENTER.**
 - The screen will be switched to the [GEOMETRIC CORRECTION] menu.
The adjustment completion screen will be displayed on.
6. **Press ◀ or ▶ button to move the cursor onto [OK] then press [ENTER].**
 - The adjusted values for WARP are stored and the screen display goes back to the [GEOMETRIC CORRECTION].

TIP:

A commercially available USB mouse is available to perform correction. (→ page 38)

PC TOOL

Recall the geometric correction data that is registered in the projector beforehand.
Three types of correction data can be registered.

NOTE:

- *As electrical correction is carried out in geometric correction, the brightness may be affected and the picture quality may be degraded.*
-

RESET

Reset the adjustment value that has been set up as MODE in GEOMETRIC CORRECTION (return to the initial value).

- This is ineffective when MODE is set OFF.
- Reset can be executed by pressing and holding the Geometric. button on the remote control for over 2 seconds.

[EDGE BLENDING]

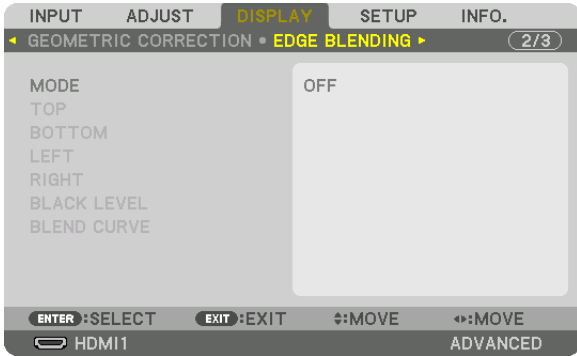

This adjusts the edges (boundaries) of the projection screen when projecting high resolution videos using a combination of several projectors in the up, down, left and right positions.

MODE

This enables or disables the EDGE BLENDING function. When MODE is set to ON, the TOP, BOTTOM, LEFT, RIGHT, BLACK LEVEL and BLEND CURVE settings can be adjusted.

TOP/BOTTOM/LEFT/RIGHT

This selects the EDGE BLENDING locations on the left, right, top and bottom on the screen. The following settings can be adjusted when an item is selected. (→ page 69)

- CONTROL Enable TOP, BOTTOM, LEFT and RIGHT functions.
- MARKER..... Set whether to display marker or not when adjusting the range and display position. When turned on, a magenta marker for adjusting the range adjustment and a green marker for adjusting the display position will be displayed.
- RANGE..... Adjust the range (width) of the edge blending.
- POSITION Adjust the display position of the edge blending.

BLACK LEVEL

Divide the screen into nine parts and keep the black level uniform for each projector. The nine divisions screens are TOP-LEFT, TOP-CENTER, TOP-RIGHT, CENTER-LEFT, CENTER, CENTER-RIGHT, BOTTOM-LEFT, BOTTOM-CENTER and BOTTOM-RIGHT. (→ page 72)

BLEND CURVE

Set brightness for the EDGE BLENDING sections. (→ page 71)

[MULTI SCREEN]

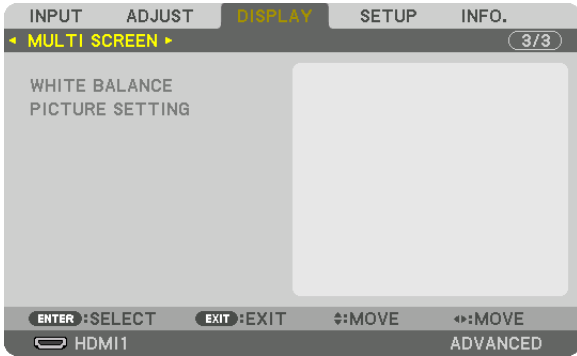

WHITE BALANCE

This adjusts the white balance for each projector when projecting using a combination of several projectors. This can be adjusted when [MODE] is set to [ON].

- CONTRAST W, CONTRAST R, CONTRAST G, CONTRAST B
..... Adjusting the white color of the video.
- BRIGHTNESS W, BRIGHTNESS R, BRIGHTNESS G, BRIGHTNESS B
..... Adjusting the black color of the video.

PICTURE SETTING

This sets the division condition when projecting using a combination of several projectors. Please refer to “4. Multi-Screen Projection” (→ page 60) for details.

MODE	OFF	Use the projector in a standalone state.
	ZOOM	This adjusts the position and width of the video area that you wish to divide. The edge blending width will also be automatically set to that width.
	TILING	This assigns the divided screens to the projectors. The edge blending function will also be set automatically.
ZOOM	HORIZONTAL ZOOM	This enlarges the video area in the horizontal direction.
	VERTICAL ZOOM	This enlarges the video area in the vertical direction.
	HORIZONTAL POSITION	This shifts the video area in the horizontal direction.
	VERTICAL POSITION	This shifts the video area in the vertical direction.
TILING	WIDTH	This selects the number of projectors to be arranged horizontally.
	HEIGHT	This selects the number of projectors to be arranged vertically.
	HORIZONTAL POSITION	This selects the position of the projector starting from the left among those arranged horizontally.
	VERTICAL POSITION	This selects the position of the projector starting from the top among those arranged vertically.

Conditions for using tiling

- All the projectors need to fulfil the following conditions.
 - The panel size must be the same
 - The projection screen size must be the same
 - The left and right ends or top and bottom ends of the projection screen must be consistent.
 - The settings for the left and right edges of the edge blending are the same
 - The settings for the top and bottom edges of the edge blending are the same

If the tiling conditions are satisfied, the video screen of the projector at each installation position will be automatically extracted and projected.

If the tiling conditions are not satisfied, adjust the video screen of the projector at each installation position using the zoom function.

- Assign a unique control ID to each projector.
- Set the “Color setting” and “DeepColor setting” on your Blu-ray player or computer to “Auto”. Refer to the owner’s manual accompanied with your Blu-ray player or computer for more information. Connect an HDMI output signal of your Blu-ray player or computer to the first projector and then connect to the HDBaseT OUT/Ethernet port on the first projector to the HDBaseT IN/Ethernet port on the second projector, same to the sequel projectors..

Tiling setting example) Number of horizontal units = 2, Number of vertical units = 2

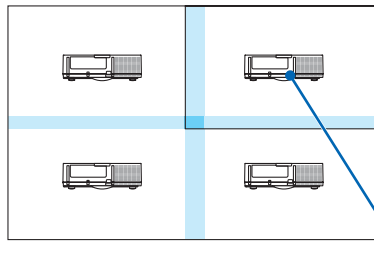

*Horizontal order = Second unit
Vertical order = First unit*

7 Menu Descriptions & Functions [SETUP]

[MENU(1)]



Selecting Menu Language [LANGUAGE]

You can choose one of 30 languages for on-screen instructions.

NOTE: Your setting will not be affected even when [RESET] is done from the menu.

Selecting Menu Color [COLOR SELECT]

You can choose between two options for menu color: COLOR and MONOCHROME.

Turning On / Off Source Display [INPUT DISPLAY]

This option turns on or off input name display such as HDMI1, HDMI2, DisplayPort, COMPUTER, HDBaseT to be displayed on the top right of the screen.

Turning messages on and off [MESSAGE DISPLAY]

This option selects whether or not to display projector messages at the bottom of the projected image. Even when "OFF" is selected, the security lock warning is displayed. The security lock warning turns off when the security lock is canceled.

Turning ON/OFF Control ID [ID DISPLAY]

ID DISPLAY This option turns on or off the ID number which is displayed when the ID SET button on the remote control is pressed. (→ page 121)

[3D CAUTION MESSAGE]

This selects whether to display a caution message or not when switching to a 3D video. The default condition when shipped from the factory is ON.

OFF The 3D caution message screen will not be displayed.

ON The 3D caution message screen will be displayed when switching to a 3D video. Press the ENTER button to cancel the message.

- The message will disappear automatically after 60 seconds or when other buttons are pressed. If it disappears automatically, the 3D caution message will be displayed again when switching to a 3D video.

Selecting Menu Display Time [DISPLAY TIME]

This option allows you to select how long the projector waits after the last touch of a button to turn off the menu. The preset choices are [MANUAL], [AUTO 5 SEC], [AUTO 15 SEC], and [AUTO 45 SEC]. The [AUTO 45 SEC] is the factory preset.

[MENU(2)]

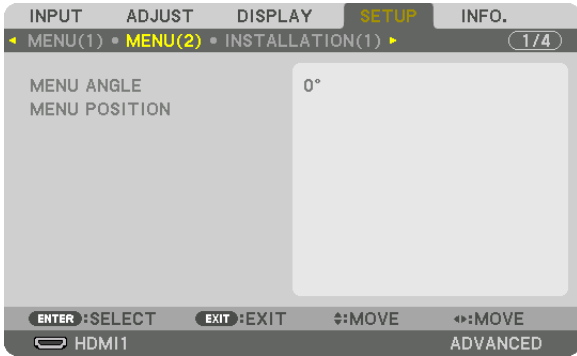

[MENU ANGLE]

Select the direction for displaying the menu.

[MENU POSITION]

Shift the menu displaying position.

HORISONTAL POSITION..... Shift the menu in the horizontal directions.

VERTICAL POSITION Shift the menu in the vertical directions.

RESET..... Reset the menu displaying position to the default factory setting (the screen center).

TIP

- Once the projector is powered off, the menu displaying position will reset to the default factory setting.
- Input terminal and message displaying position are not influenced by the [MENU POSITION].
- It enables to move the menu by mouse click when a commercially available USB mouse is connected.
- It enables to move the menu position by the ▼▲◀ and ▶ buttons holding to press the CTL button on the remote control or mouse click.
- While the MENU POSITION of the on-screen menu is displayed on and the menu is moved by the ▼▲◀ and ▶ buttons holding to press the CTL button on the remote control or by mouse click, the indication of adjusted value on the menu will not be changed. In this case, close the MENU POSITION menu once and display it again for indicating the adjusted value properly.

[INSTALLATION(1)]

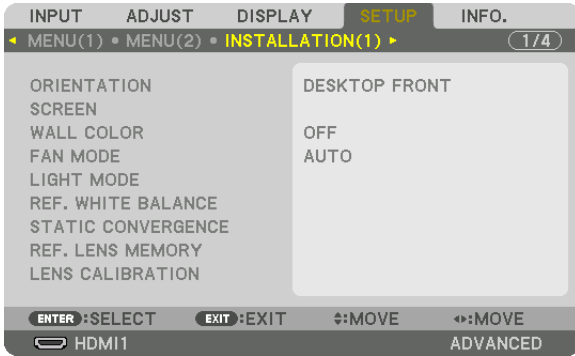

Selecting Projector Orientation [ORIENTATION]

This reorients your image for your type of projection. The options are: desktop front projection, ceiling rear projection, desktop rear projection, and ceiling front projection.

NOTE:

- Please consult the dealer if you require special installation services e.g. when mounting the projector to a ceiling. Never install the projector on your own. This may result in the projector falling down and causing injury to people.

AUTO This automatically detects and projects the DESKTOP FRONT and CEILING FRONT.

NOTE:

- The DESKTOP REAR and CEILING REAR will not be detected. Please select manually.

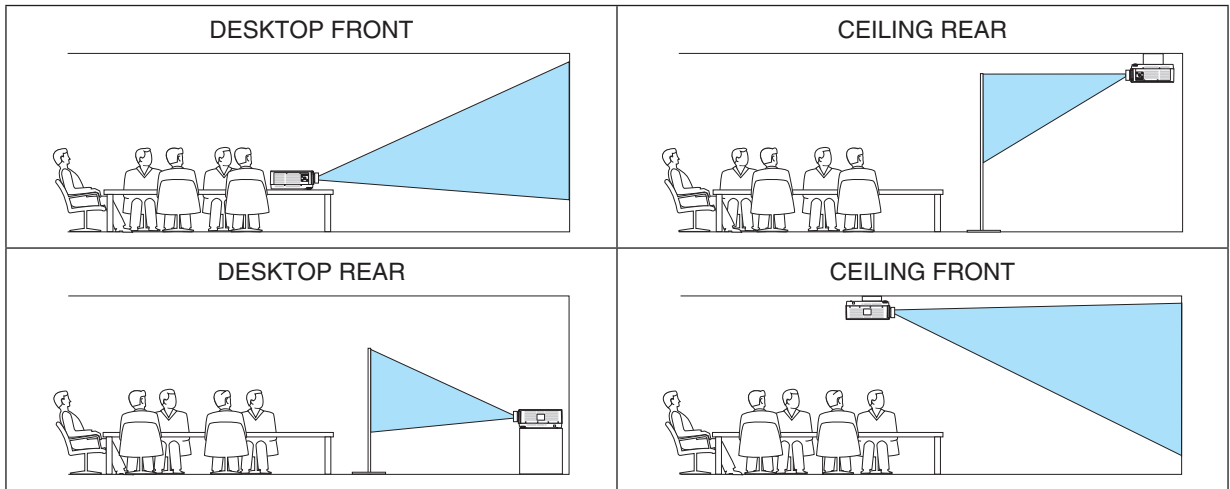

TIP:

- Check whether the automatic DESKTOP FRONT is installed within ± 10 degrees for floor installation and whether the CEILING FRONT is within ± 10 degrees for ceiling installation. Select manually when the projection screen is inverted.

Selecting Aspect Ratio and Position for Screen [SCREEN]

[SCREEN TYPE]

Sets the aspect ratio of the projection screen.

- FREE The ratio of the liquid crystal panel is selected. Select this when projecting multi-screen and 17:9 screen (2K).
- 4:3 SCREEN For a screen with a 4:3 aspect ratio
- 16:9 SCREEN For a screen with a 16:9 aspect ratio
- 16:10 SCREEN For a screen with a 16:10 aspect ratio

NOTE:

- After changing the screen type, check the setting of [ASPECT RATIO] in the menu. (→ page 92)

[POSITION]

Adjust the screen position. Depending on the model you use and the screen type, the function may become ineffective and the adjustable range may vary.

Using the Wall Color Correction [WALL COLOR]

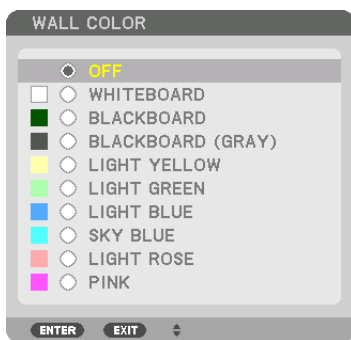

This function allows for quick adaptive color correction in applications where the screen material is not white.

NOTE: Selecting [WHITEBOARD] reduces light source brightness.

Selecting Fan Mode [FAN MODE]

Fan Mode is used to set the speed of the internal cooling fan.

- MODE Select one among four modes: AUTO, NORMAL, HIGH, and HIGH ALTITUDE.
 - AUTO: The built-in fans automatically run at variable speed according to the detected temperature and atmospheric pressure by the built-in sensor.
 - NORMAL: The built-in fans run at the appropriate speed based on the detection by the built-in temperature sensor.
 - HIGH: The built-in fans run at high speed
 - HIGH ALTITUDE: The built-in fans run at high speed. Select this option when using the projector at altitudes approximately 5500 feet/1700 meters or higher.

NOTE:

- Make sure the speed is set to [HIGH] when you are using this device continuously for several days.
- Set [FAN MODE] to [AUTO] or [HIGH ALTITUDE] when using the projector at altitudes approximately 5500 feet/1700 meters or higher.
- Using the projector at altitudes approximately 5500 feet/1700 meters or higher without setting to [AUTO] or [HIGH ALTITUDE] can cause the projector to overheat and the protector could shut down. If this happens, wait a couple minutes and turn on the projector.
- Using the projector at altitudes less than approximately 5500 feet/1700 meters and setting to [HIGH ALTITUDE] can cause the projector to overcool, causing the image to flicker. Switch [FAN MODE] to [AUTO].
- Using the projector at altitudes approximately 5500 feet/1700 meters or higher can shorten the life of optical components such as the light source.
- Your setting will not be affected even when [RESET] is done from the menu.

- TIP:**
- When [HIGH ALTITUDE] is selected for [FAN MODE], a symbol icon  will be displayed at the bottom of the menu.

[LIGHT MODE]

Adjusting the energy savings settings and the brightness of each projector in multi-screen projection. For energy savings settings, see page 33 “3-6. Changing LIGHT MODE/Checking Energy-Saving Effect Using LIGHT MODE [LIGHT MODE]”.

LIGHT MODE	NORMAL	The light module luminance (brightness) will become 100% and the screen will turn bright.
	ECO1	By controlling the brightness and fan speed according to the selected setting, energy can be saved and motion noise and the power consumption can be lowered.
	ECO2	
	LONG LIFE	The mode optimizes the service life of the optimal parts. The brightness is about 30% of NORMAL.
CONSTANT BRIGHTNESS	OFF	[CONSTANT BRIGHTNESS] mode will be canceled.
	ON	<p>Maintains the brightness that is in effect at the time [ON] is selected. Unless [OFF] is selected, the same settings will remain in effect even when the projector is turned off.</p> <ul style="list-style-type: none"> To re-adjust the brightness, first turn this setting OFF before making further adjustments. <p>NOTE:</p> <ul style="list-style-type: none"> [CONSTANT BRIGHTNESS] mode is a function used to maintain the brightness at a constant level. Color will not be fixed.
REF. LIGHT ADJUST		<p>Brightness can be adjusted in 1% increments from 25 to 100%.</p> <p>When several projectors are used for multi-screen projection, the brightness can be adjusted individually on each projector.</p>

- * [LIGHT MODE] is available when [OFF] is selected for [CONSTANT BRIGHTNESS].
- * [REF. LIGHT ADJUST] is available when [NORMAL] is selected for [LIGHT MODE] and [OFF] is selected for [CONSTANT BRIGHTNESS].

- TIP:**
- Brightness normally decreases with use, but by selecting [CONSTANT BRIGHTNESS] mode, sensors inside the projector detect brightness and automatically adjust the output, thereby maintaining a constant brightness throughout the life of the light module. However, if output is already at its maximum, brightness will decrease with use. For this reason, when using multi-screen projection, it is recommended to adjust the brightness to a slightly lower level, then setting the [CONSTANT BRIGHTNESS] mode to [ON].

[REF. WHITE BALANCE]

This feature allows you to adjust the white balance for all signals. The white and black levels of the signal are adjusted for optimum color reproduction. Uniformity is also adjusted when the redness (R) and blueness (B) of the white color in the screen’s horizontal (left/right) direction are uneven.

- CONTRAST R/CONTRAST G/CONTRAST B.....These adjust the picture’s white color.
- BRIGHTNESS R/BRIGHTNESS G/BRIGHTNESS BThese adjust the picture’s black color.
- UNIFORMITY R.....The further this is set to the + side, the stronger the redness on the left side of the picture (increasing towards the left edge) and the weaker the redness on the right side of the picture (decreasing towards the right edge).
This is reversed when set to the – side.
- UNIFORMITY B.....The further this is set to the + side, the stronger the blueness on the left side of the picture (increasing towards the left edge) and the weaker the blueness on the right side of the picture (decreasing towards the right edge).
This is reversed when set to the – side.

[STATIC CONVERGENCE]

This feature allows you to adjust for color deviation in the picture.

This can be adjusted in units of ± 1 pixel in the horizontal direction for HORIZONTAL R, G and B, in the vertical direction for VERTICAL R, G and B.

Using the Reference Lens Memory Function [REF. LENS MEMORY]

This function serves to store the adjusted values common to all input sources when using the LENS SHIFT, ZOOM and FOCUS buttons of the projector or the remote control. The adjusted values stored in memory can be used as a reference to the current.

PROFILE Select a stored [PROFILE] number.

STORE Stores the current adjusted values in memory as a reference.

MOVE Applies the adjusted reference values stored in [STORE] to the current signal.

RESET..... Reset selected [PROFILE] number [REF. LENS MEMORY] to the factory default settings.

LOAD BY SIGNAL .. When you switch signals the lens will shift to the lens shift, zoom, and focus values for the selected [PROFILE] number.

If no adjusted values have been saved to [LENS MEMORY], the lens will apply [REF. LENS MEMORY] adjusted values. Alternatively, if no adjusted values have been saved to [REF. LENS MEMORY], the unit will return to factory default settings.

FORCED MUTE To turn off the image during lens shift, select [YES].

NOTE:

- Adjusted values in [REF. LENS MEMORY] will not be returned to default when performing [CURRENT SIGNAL] or [ALL DATA] for [RESET] from the menu.
 - To store adjusted values for each input source, use the Lens Memory function. (→ page 54, 97)
-

[LENS CALIBRATION]

The adjustment range of the zoom, focus, and shift of the mounted lens is calibrated.

Be sure to carry out [LENS CALIBRATION] after replacing the lens.

[INSTALLATION(2)]



[SHUTTER SETTINGS]

Enabling and disabling the lens shutter function. You can also set how long the light will take to fade in and fade out when either the SHUTTER button on the remote control.

POWER ON SHUTTER	OPEN	When the power is turned on, the light source comes on and the picture is projected.
	CLOSE	The light source does not come on when the power is turned on. When the SHUTTER button is pressed, the shutter is released and the light source is turned on.
FADE IN TIME	Set how long the light will take to fade in after the SHUTTER button is pressed. The time can be set from 0 to 10 seconds in increments of 1 second.	
FADE OUT TIME	Set how long the light will take to fade out after the SHUTTER button is pressed. The time can be set from 0 to 10 seconds in increments of 1 second.	

[CONTROL]

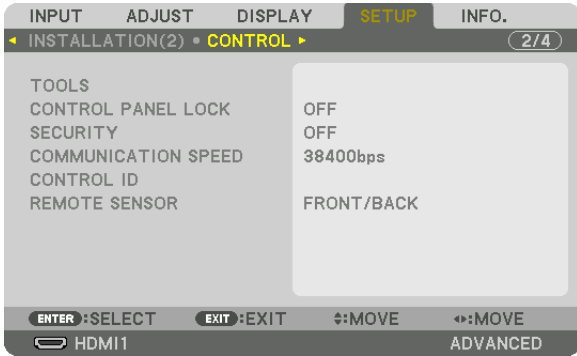

TOOLS

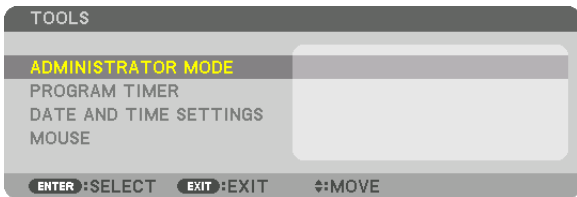

ADMINISTRATOR MODE

This allows you to select MENU MODE, save settings, and set a password for the administrator mode.

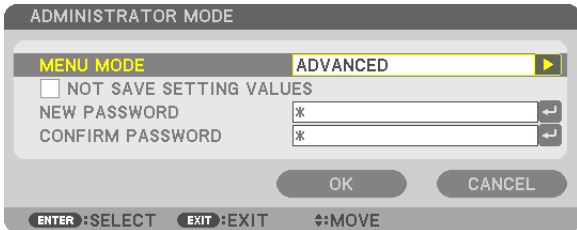

MENU MODE	Select either [BASIC] or [ADVANCED] menu. (→ page 76)	—
NOT SAVE SETTING VALUES	Placing a check mark will not save your projector settings. Clear this check box to save your projector settings.	—
NEW PASSWORD/ CONFIRM PASS- WORD	Assign a password for the administrator mode.	Up to 10 alphanumeric characters

PROGRAM TIMER

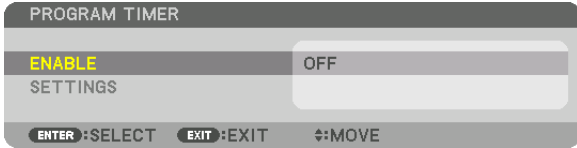

This option turns on/standby the projector and changes video signals, and selects LIGHT mode automatically at a specified time.

NOTE:

- Before using [PROGRAM TIMER], make sure that the [DATE AND TIME] feature is set. (→ page 120)
 Make sure that the projector is in the standby condition with the POWER cord connected.
 The projector has a built-in clock. The clock will keep working for about a month after the main power is turned off. If the main power is not supplied to the projector for a month or more, it requires to set [DATE AND TIME SETTINGS] feature again.

Setting a new program timer

1. On the PROGRAM TIMER screen, use the ▲ or ▼ button to select [SETTINGS] and press the ENTER button.



The [PROGRAM LIST] screen will be displayed.

2. Select a blank program number and press the ENTER button.



The [EDIT] screen will be displayed.

3. Make settings for each item as required.

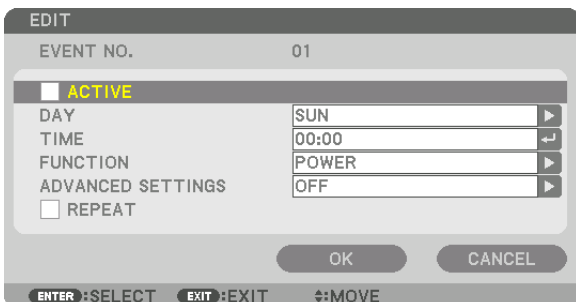

ACTIVE Place a check mark to enable the program.

DAY..... Select days of the week for the program timer. To execute the program from Monday to Friday, select [MON-FRI]. To execute the program in everyday basis, select [EVERYDAY].

TIME..... Set the time to execute the program. Enter time in 24-hour format.

FUNCTION..... Select a function to be executed. Selecting [POWER] will allow you to turn on or off the projector by setting [ADVANCED SETTINGS]. Selecting [INPUT] will allow you to select an input terminal by setting [ADVANCED SETTINGS]. Selecting [LIGHT MODE] will allow you to select one option among [NORMAL], [ECO1], [ECO2] and [LONG LIFE] for [LIGHT MODE] by setting [ADVANCED SETTINGS].

ADVANCED SETTINGS

..... Select one option for the selected item in [FUNCTION].

REPEAT..... Place a check mark to repeat the program continuing basis. To use the program this week only, clear the check mark.

4. Select [OK] and press the ENTER button.

This will complete the settings.

You will be returned to the [PROGRAM LIST] screen.

5. Select [↶] (BACK) and press the ENTER button.

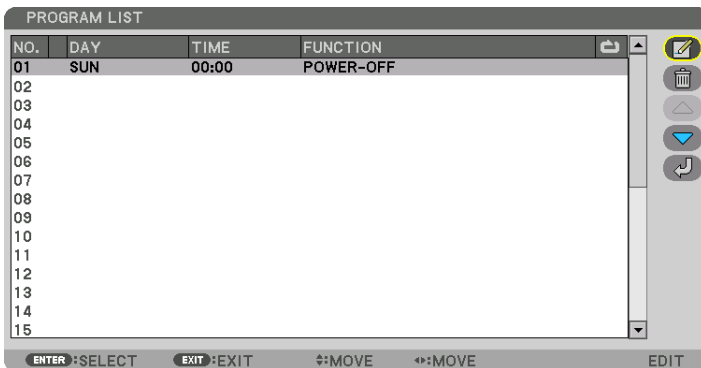

You will be returned to the [PROGRAM TIMER] screen.

6. Select [EXIT] and press the ENTER button.

You will be returned to the [TOOLS] screen.

NOTE:

- Up to 30 different timer settings can be programmed.
- The Program Timer is executed on a set time basis, not in a program basis.
- Once the program not marked with a check in [REPEAT] has been executed, the check mark in the [ACTIVE] check box will be cleared automatically and the program will be disabled.
- When the on-time and the off-time set for the same time, the off-time setting will take preference.
- When two different sources are set for the same time, the larger program number will take preference.
- The on-time setting will not be executed while the cooling fans are running or an error is occurring.
- If the off-time setting is expired under the condition in which the power off is not possible, the off-timer setting will not be executed until the power off becomes possible.
- Programs not marked with a check mark in [ACTIVE] of the [EDIT] screen will not be executed even if the Program Timer is enabled.
- When the projector is turned on by using the program timer and if you want to turn off the projector, set the off-time or do it manually so as not to leave the projector on for a long period of time.

Activating the program timer

1. Select **[ENABLE]** on the **[PROGRAM TIMER]** screen and press the **ENTER** button.

The selection screen will be displayed.

2. Press the **▼** button to align the cursor with **[ON]** and then press the **ENTER** button.

Return to the [PROGRAM TIMER] screen.

NOTE:

- When the effective settings of the **[PROGRAM TIMER]** have not been set to **[ON]**, the program will not be executed even if the **[ACTIVE]** items in the program list have been ticked.
 - Even when the effective settings of the **[PROGRAM TIMER]** are set to **[ON]**, the **[PROGRAM TIMER]** will not work until the **[PROGRAM TIMER]** screen is closed.
-

Editing the programmed settings

1. On the **[PROGRAM LIST]** screen, select a program you want to edit and press the **ENTER** button.

2. Change the settings on the **[EDIT]** screen.

3. Select **[OK]** and press the **ENTER** button.

The programmed settings will be changed.

You will be returned to the [PROGRAM LIST] screen.

Changing the order of programs

1. On the **[PROGRAM LIST]** screen, select a program whose order you want to change and press the **►** button.

2. Press the **▼** button to select **▲** or **▼**.

3. Press the **ENTER** button a few times to select a row to which you wish to move the program.

The order of the programs will be changed.

Deleting the programs

1. On the **[PROGRAM LIST]** screen, select a program number you want to delete and press the **►** button.

2. Press the **▼** button to select **[ (DELETE)]**.

3. Press the **ENTER** button.

The confirmation screen will be displayed.

4. Select **[YES]** and press the **ENTER** button.

The program will be deleted.

This will complete deleting the program.

DATE AND TIME SETTINGS

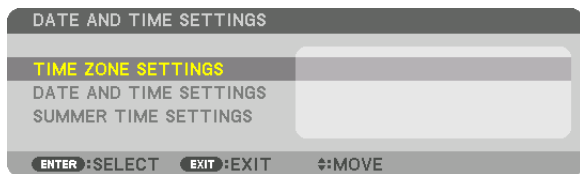

You can set the current time, month, date, and year.

NOTE: The projector has a built-in clock. The clock will keep working for about a month after the main power is turned off. If the main power is off for a month or more, the built-in clock will cease. If the built-in clock ceases, set the date and time again. The built-in clock will not cease while in the standby mode. In order to activate the built-in clock continuously even when the projector is not used, leave it in the standby state not plugging off the power cord.

TIME ZONE SETTINGS..... Select your time zone.

DATE AND TIME SETTINGS Set your current date (MM/DD/YYYY) and time (HH:MM).

INTERNET TIME SERVER: If you place a check mark, the projector's built-in clock will be synchronized with an Internet time server in every 24 hours and at the time of projector's startup.

UPDATE: Synchronizes the projector's built-in clock immediately. The UPDATE button is not available unless the INTERNET TIME SERVER check box is turned on.

SUMMER TIME SETTINGS If you place a check mark, the clock for daylight saving will be enabled.

[MOUSE]

This function is for using a commercially available USB mouse via the USB-A port on this projector.

BUTTON..... Select for using the mouse either by right or left hand.

SENSITIVITY..... Select the sensitivity of mouse among FAST, MIDDLE and LOW.

NOTE: This setting is not guaranteed motion of all commercially available USB mouses.

Disabling the Cabinet Buttons [CONTROL PANEL LOCK]

This option turns on or off the CONTROL PANEL LOCK function.

NOTE:

- How to cancel the [CONTROL PANEL LOCK]
When the [CONTROL PANEL LOCK] is set to [ON], press the INPUT button on the main body for about 10 seconds to cancel the [CONTROL PANEL LOCK] setting.

TIP:

- When the [CONTROL PANEL LOCK] is turned on, a key lock icon [] will be displayed at the bottom right of the menu.
- This CONTROL PANEL LOCK does not affect the remote control functions.

Enabling Security [SECURITY]

This feature turns on or off the SECURITY function.

Unless the correct keyword is entered, the projector cannot project an image. (→ page 41)

NOTE: Your setting will not be affected even when [RESET] is done from the menu.

Selecting Communication Speed [COMMUNICATION SPEED]

This feature sets the communication speed for the PC Control port (D-Sub 9P). Make sure to set the appropriate speed for the device to connect.

NOTE:

- Your selected communication speed will not be affected even when [RESET] is done from the menu.

Setting ID to the Projector [CONTROL ID]

You can operate multiple projectors separately and independently with the single remote control that has the CONTROL ID function. If you assign the same ID to all the projectors, you can conveniently operate all the projectors together using the single remote control. To do so, you have to assign an ID number to each projector.

CONTROL ID NUMBER..... Select a number from 1 to 254 you wish to assign to your projector.

CONTROL ID..... Select [OFF] to turn off the CONTROL ID setting and select [ON] to turn on the CONTROL ID setting.

NOTE:

- When [ON] is selected for [CONTROL ID], the projector cannot be operated by using the remote control that does not support the CONTROL ID function. (In this case the buttons on the projector cabinet can be used.)
- Your setting will not be affected even when [RESET] is done from the menu.
- Pressing and holding the ENTER button on the projector cabinet for 10 seconds will display the menu for canceling the Control ID.

Assigning or Changing the Control ID

1. Turn on the projector.

2. Press the ID SET button on the remote control.

The CONTROL ID screen will be displayed.

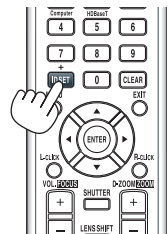
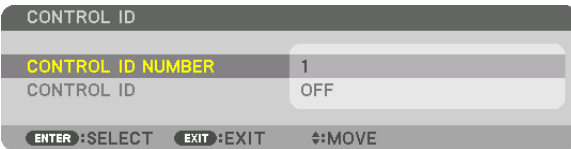

If the projector can be operated with the current remote control ID, the [ACTIVE] will be displayed. If the projector cannot be operated with the current remote control ID, the [INACTIVE] will be displayed. To operate the inactive projector, assign the control ID used for the projector by using the following procedure (Step 3).

3. Press one of numeric keypad buttons while pressing and holding the ID SET button on the remote control.

Example:

To assign "3", press the "3" button on the remote control.

No ID means that all the projectors can be operated together with a single remote control. To set "No ID", enter "000" or press the CLEAR button.

TIP: The range of IDs is from 1 to 254.

4. Release the ID SET button.

The updated CONTROL ID screen will be displayed.

NOTE:

- The IDs can be cleared in a few days after the batteries are run down or removed.
- Accidentally pressing any one of the buttons of the remote control will clear currently specified ID with batteries removed.

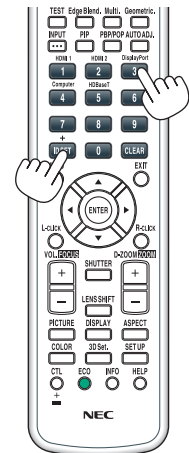

Turning On or Off Remote Sensor [REMOTE SENSOR]

This option determines which remote sensor on the projector is enabled in wireless mode. The options are: FRONT/BACK, FRONT, BACK, and HDBaseT*.

NOTE:

- *The remote control of the projector will not be able to receive signals if the power supply of the HDBaseT transmission device connected to the projector is switched on when this has been set to "HDBaseT".*
-

TIP:

- *If the remote control system does not function when direct sunlight or strong illumination strikes the remote control sensor of the projector, change to other option.*

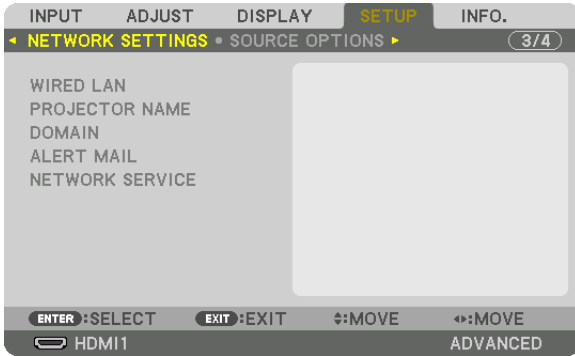
[NETWORK SETTINGS]*Important:*

- Consult with your network administrator about these settings.
- When using a wired LAN, connect the Ethernet cable (LAN cable) to the LAN port on the projector. (→ page 150)
- Please use a shielded twisted pair (STP) cable of Category 5e or higher for the LAN cable (sold commercially).

TIP: The network settings you make will not be affected even when [RESET] is done from the menu.

Hints on How to Set Up LAN Connection**To set up the projector for a LAN connection:**

Select [WIRED LAN] → [PROFILES] → [PROFILE 1] or [PROFILE 2].

Two settings can be set for wired LAN.

Next turn on or off for [DHCP], [IP ADDRESS], [SUBNET MASK], and [GATEWAY] and select [OK] and press the ENTER button. (→ page 124)

To recall LAN settings stored in the profile number:

Select [PROFILE 1] or [PROFILE 2] for wired LAN, and then select [OK] and press the ENTER button. (→ page 124)

To connect a DHCP server:

Turn on [DHCP] for wired LAN. Select [ON] and press the ENTER button. To specify IP address without using the DHCP server, turn off [DHCP]. (→ page 124)

To receive error messages via e-mail:

Select [ALERT MAIL], and set [SENDER'S ADDRESS], [SMTP SERVER NAME], and [RECIPIENT'S ADDRESS]. Last, select [OK] and press the ENTER button. (→ page 126)

WIRED LAN

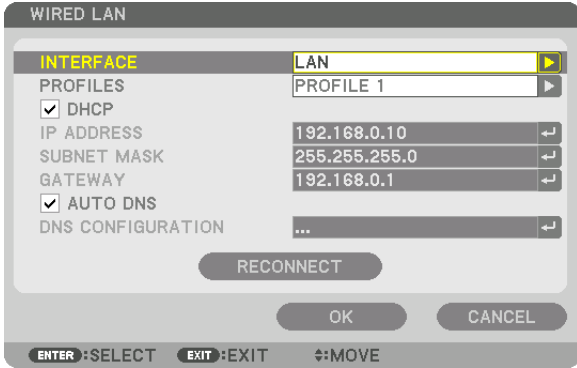

INTERFACE	Select [LAN] for using the LAN port for connecting to the wired LAN. Select [HDBaseT] for using the HDBaseT IN/Ethernet port for connecting to the wired LAN. The control from the connected device will be disabled if no signal is sent and received for three minutes if the projector is connected to wired LAN thru the HD-BaseT IN/Ethernet. For refusing this, set the standby mode to [SLEEP] in advance.	—
PROFILES	<ul style="list-style-type: none"> The settings for the wired LAN can be recorded in the projector memory in two ways. Select [PROFILE 1] or [PROFILE 2] and then do settings for [DHCP] and the other options. After doing this, select [OK] and press the ENTER button. This will store your settings in memory. To recall the settings from memory: After selecting [PROFILE 1] or [PROFILE 2] from the [PROFILES] list. Select [OK] and press the ENTER button. Select [DISABLE] when not connecting to a wired LAN 	—
DHCP	Place a check mark to automatically assign an IP address to the projector from your DHCP server. Clear this check box to register the IP address or subnet mask number obtained from your network administrator.	—
IP ADDRESS	Set your IP address of the network connected to the projector when [DHCP] is turned off.	Up to 12 numeric characters
SUBNET MASK	Set your subnet mask number of the network connected to the projector when [DHCP] is turned off.	Up to 12 numeric characters
GATEWAY	Set the default gateway of the network connected to the projector when [DHCP] is turned off.	Up to 12 numeric characters
AUTO DNS	Place a check mark to automatically assign the IP address of your DNS server connected to the projector from your DHCP server. Clear this check box to set the IP address of your DNS server connected to the projector.	Up to 12 numeric characters
DNS CONFIGURATION	Set the IP address of your DNS server on the network connected to the projector when [AUTO DNS] is cleared.	Up to 12 numeric characters
RECONNECT	Retry to connect the projector to a network. Try this if you have changed [PROFILES].	—

PROJECTOR NAME

PROJECTOR NAME	Set a unique projector name.	Up to 16 alphanumeric characters and symbols
----------------	------------------------------	--

DOMAIN

Set a host name and domain name of the projector.

HOST NAME	Set a host name of the projector.	Up to 16 alphanumeric characters
DOMAIN NAME	Set a domain name of the projector.	Up to 60 alphanumeric characters

ALERT MAIL

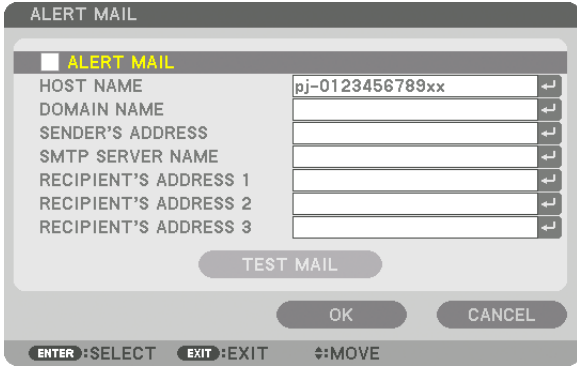

ALERT MAIL	<p>This option will notify your computer of error messages via e-mail when using wireless or wired LAN.</p> <p>Placing a checkmark will turn on the Alert Mail feature.</p> <p>Clearing a checkmark will turn off the Alert Mail feature.</p> <p>Sample of a message to be sent from the projector:</p> <div style="border: 1px solid black; padding: 5px;"> <p>Subject: [Projector] Projector Information THE COOLING FAN HAS STOPPED. [INFORMATION] PROJECTOR NAME: xxxxx LIGHT HOURS USED: xxxxx[H]</p> </div>	—
HOST NAME	Type in a host name.	Up to 16 alphanumeric characters
DOMAIN NAME	Type in a domain name of the network connected to the projector.	Up to 60 alphanumeric characters
SENDER'S ADDRESS	Specify the sender's address.	Up to 60 alphanumeric characters and symbols
SMTP SERVER NAME	Type in the SMTP server name to be connected to the projector.	Up to 60 alphanumeric characters
RECIPIENT'S ADDRESS 1, 2, 3	Type in your recipient's address.	Up to 60 alphanumeric characters and symbols
TEST MAIL	<p>Send a test mail to check if your settings are correct.</p> <p><i>NOTE:</i></p> <ul style="list-style-type: none"> • If you entered an incorrect address in a test, you may not receive an Alert mail. Should this happen, check if the Recipient's Address is correctly set. • Unless any one of the [SENDER'S ADDRESS], [SMTP SERVER'S NAME] or [RECIPIENT'S ADDRESS 1-3] is selected, [TEST MAIL] is not available. • Be sure to highlight [OK] and press the ENTER button before executing [TEST MAIL]. 	—

NETWORK SERVICE

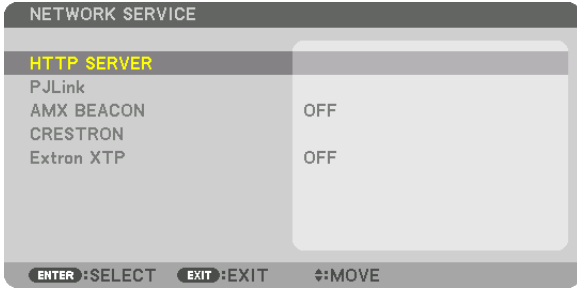

HTTP SERVER	Set a password for your HTTP server.	Up to 10 alphanumeric characters
PJLink	<p>This option allows you to set a password when you use the PJLink feature.</p> <p><i>NOTE:</i></p> <ul style="list-style-type: none"> Do not forget your password. However, if you forget your password, consult with your dealer. What is PJLink? PJLink is a standardization of protocol used for controlling projectors of different manufacturers. This standard protocol is established by Japan Business Machine and Information System Industries Association (JBMIA) in 2005. The projector supports all the commands of PJLink Class 1. Setting of PJLink will not be affected even when [RESET] is done from the menu. 	Up to 32 alphanumeric characters
AMX BEACON	<p>Turn on or off for detection from AMX Device Discovery when connecting to the network supported by AMX's NetLinx control system.</p> <p><i>TIP:</i> When using a device that supports AMX Device Discovery, all AMX NetLinx control system will recognize the device and download the appropriate Device Discovery Module from an AMX server.</p> <p>Placing a checkmark will enable detecting the projector from AMX Device Discovery. Clearing a checkmark will disable detecting the projector from AMX Device Discovery.</p>	—
CRESTRON	<p>ROOMVIEW: Turn on or off when controlling the projector from your PC. CRESTRON CONTROL: Turn on or off when controlling the projector from your controller.</p> <ul style="list-style-type: none"> CONTROLLER IP ADDRESS: Enter your IP address of CRESTRON SERVER. IP ID: Enter your IP ID of CRESTRON SERVER. 	Up to 12 numeric characters
Extron XTP	Set for connecting this projector to the Extron XTP transmitter. ON will enable to connect with the XTP transmitter. OFF will disable to connect with the XTP transmitter.	—

TIP: The CRESTRON settings are required only for use with CRESTRON ROOMVIEW. For more information, visit <http://www.crestron.com>

[SOURCE OPTIONS]

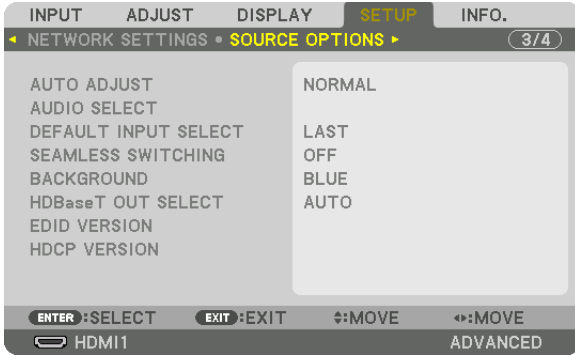

Setting Auto Adjust [AUTO ADJUST]

This feature sets the Auto Adjust mode so that the computer signal can be automatically or manually adjusted for noise and stability. You can automatically make adjustment in two ways: [NORMAL] and [FINE].

- OFF The computer signal will not be automatically adjusted. You can manually optimize the computer signal.
- NORMAL..... Default setting. The computer signal will be automatically adjusted. Normally select this option.
- FINE..... Select this option if fine adjustment is needed. It takes more time to switch to the source than when [NORMAL] is selected.

TIP:

- The default setting when shipped from the factory is [NORMAL].
- When the AUTO ADJ. button is pressed, the same [FINE] adjustment is carried out.

[AUDIO SELECT]

This selects the audio input of the HDMI 1 IN terminal, HDMI 2 IN terminal, DisplayPort IN terminal and HDBaseT IN/Ethernet port.

Selecting Default Source [DEFAULT INPUT SELECT]

You can set the projector to default to any one of its inputs each time the projector is turned on.

- LAST Sets the projector to default to the previous or last active input each time the projector is turned on.
- AUTO Searches for an active source in order of HDMI1 → HDMI2 → DisplayPort → COMPUTER → HDBaseT and displays the first found source.
- HDMI1 Displays the digital source from the HDMI 1 IN connector every time the projector is turned on.
- HDMI2 Displays the digital source from the HDMI 2 IN connector every time the projector is turned on.
- DisplayPort Displays the digital source from the DisplayPort every time the projector is turned on.
- COMPUTER Displays the computer signal from the COMPUTER IN connector every time the projector is turned on.
- HDBaseT Project the HDBaseT signal.

[SEAMLESS SWITCHING]

When the input connector is switched, the image displayed before switching is held to switch to the new image without a break due to absence of a signal.

Selecting a Color or Logo for Background [BACKGROUND]

Use this feature to display a blue/black screen or logo when no signal is available. The default background is [BLUE].

NOTE:

- Even when the background logo is selected, if two pictures are displayed in [PIP/PICTURE BY PICTURE] mode, the blue background is displayed without the logo when there is no signal.

[HDBaseT OUT SELECT]

Select signal to output from the HDBaseT OUT/Ethernet port on the projector. When two images are projected simultaneously (PIP/PICTURE BY PICTURE), the image for the main screen is output.

- AUTO Output the input signal. When [PIP] has been set, the input signal for the main screen is output.
- HDMI1 Output the input signal thru the HDMI 1 IN terminal.
- HDMI2 Output the input signal thru the HDMI 2 IN terminal.
- DisplayPort..... Output the input signal thru the DisplayPort IN terminal.
- HDBaseT..... Output the input signal thru the HDBaseT IN/Ethernet port.

NOTE:

- Signal thru the COMPUTER IN terminal can not be output. In the state [PIP] or [PICTURE BY PICTURE] has been set and [AUTO] has been set for this function, moreover, the input terminal for the main screen is the COMPUTER and the input terminal for the sub screen is one among the HDMI 1 IN, HDMI 2 IN, DisplayPort IN terminals, or HDBaseT IN/Ethernet port, the signal from the sub screen will be output.
- If the set input terminals for main and sub screen for [PIP] and [PICTURE BY PICTURE] are differed from the selected input terminals, any image will be output.
- 4K60p and 4K50p signals can not be output.

[EDID VERSION]

Switch the EDID version for the HDMI 1 IN and HDMI 2 IN terminals.

- MODE1 Supports general signal
 - MODE2 Supports 4K signal
- Select this mode for displaying 4K image using the device supporting 4K

NOTE:

If image and sound can not be output in [MODE2], switch to [MODE1].

[HDCP VERSION]

Switch the HDCP version for the HDMI 1 IN, HDMI 2 IN and HDBaseT IN/Ethernet terminals.

- HDCP2.2..... Automatically switch the mode HDCP2.2 and HDCP1.4
- HDCP1.4..... Forcedly perform transmission with HDCP1.4

NOTE:

- If image and sound can not be output from the monitor connected with the HDBaseT OUT/Ethernet port, switch the HDCP version to HDCP1.4.

[POWER OPTIONS]

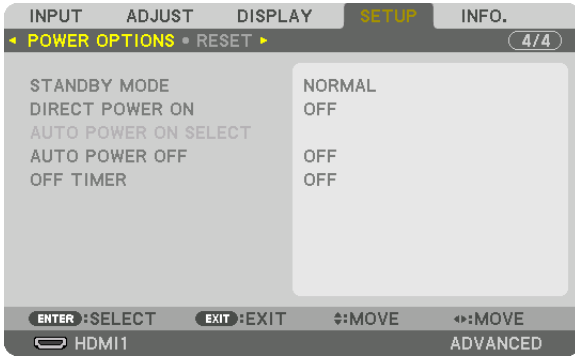

[STANDBY MODE]

Select the standby mode:

- NORMAL..... Automatically transit the standby state and control consumption power based on the projector setting and the state of the connected device. (→ page 168)
- SLEEP..... Maintain the state of sleep. Consumption power becomes higher than the setting of NORMAL. Select this mode in the following cases:
 - For using the HDBaseT IN/Ethernet and HDBaseT OUT/Ethernet ports constantly.
 - For using the USB-A port constantly.

[EXAMPLE]

- For connecting plural numbers of projector in a daisy chain. (→ page 147)
- For connecting to a HDBaseT transmission device (→ page 146)

TIP:

- The [STANDBY MODE] setting is not changed by [RESET].
- Consumption power in the STANDBY MODE is excluded from the calculation for carbon saving.

Enabling Direct Power On [DIRECT POWER ON]

Turns the projector on automatically when the power cord is inserted into an active power outlet. This eliminates the need to always use the POWER button on the remote control or projector cabinet.

Turning On the Projector by Detecting Input Signal [AUTO POWER ON SELECT]

Under the state of standby or sleep, the projector automatically detects and projects synchronizing signal input from the selected terminals among Computer, HDMI1/2, DisplayPort, and HDBaseT by this function.

- OFF AUTO POWER ON SELECT function becomes inactive.
- HDMI1, HDMI2, DisplayPort, COMPUTER, HDBaseT*
 When the projector detects the computer signal input from the selected terminal, automatically it will be turned ON and will project the computer screen.

NOTE:

- If you want to activate this AUTO POWER ON SELECT function after powering OFF the projector, interrupt signal from input terminals or pull out the computer cable from the projector and wait for over 3 seconds and then input signal from the selected terminal. In case computer signal is continuously input to the projector, however the projector is turned OFF and is in the transition to SLEEP mode, it will keep SLEEP mode and will not be turned ON automatically. In addition, if signal from HDMI1/2, DisplayPort or HDBaseT is continuously input to the projector, the projector may be turned ON again automatically based on the setting of external devices even if the projector is turned OFF and in the condition of SLEEP mode.
- This function is not activated either by component signal input from the computer screen input terminal or computer signal as Sync on Green and Composite Sync.

Enabling Power Management [AUTO POWER OFF]

When this option is selected you can enable the projector to automatically turn off (at the selected time: 0:05, 0:10, 0:15, 0:20, 0:30, 1:00) if there is no signal received by any input or if no operation is performed.

Using Off Timer [OFF TIMER]

1. **Select your desired time between 30 minutes and 16 hours: OFF, 0:30, 1:00, 2:00, 4:00, 8:00, 12:00, 16:00.**
2. **Press the ENTER button on the remote control.**
3. **The remaining time starts counting down and it is displayed at the bottom of the On-Screen Menu.**
4. **The projector will turn off after the countdown is complete.**

NOTE:

- *To cancel the preset time, set [OFF] for the preset time or turn off the power.*
 - *When the remaining time reaches 3 minutes before the projector is turned off, the [THE PROJECTOR WILL TURN OFF WITHIN 3 MINUTES] message will be displayed on the bottom of the screen.*
-

Returning to Factory Default [RESET]

The RESET feature allows you to change adjustments and settings to the factory preset for a (all) source (s) except the following:



[CURRENT SIGNAL]

Resets the adjustments for the current signal to the factory preset levels.

The items that can be reset are: [PRESET], [CONTRAST], [BRIGHTNESS], [COLOR], [HUE], [SHARPNESS], [ASPECT RATIO], [HORIZONTAL], [VERTICAL], [CLOCK], [PHASE], and [OVERSCAN].

[ALL DATA]

Reset all the adjustments and settings for all the signals to the factory preset.

All items can be reset **EXCEPT** [ENTRY LIST], [LANGUAGE], [BACKGROUND], [EDGE BLENDING], [MULTI SCREEN], [SCREEN TYPE], [GEOMETRIC CORRECTION], [REF. WHITE BALANCE], [STATIC CONVERGENCE], [ADMINISTRATOR MODE], [CONTROL PANEL LOCK], [SECURITY], [COMMUNICATION SPEED], [DATE AND TIME SETTINGS], [CONTROL ID], [STANDBY MODE], [FAN MODE], [REF. LENS MEMORY], [EDID VERSION], [HDCP VERSION], [LIGHT HOURS USED], [TOTAL CARBON SAVINGS], [WIRED LAN].

[ALL DATA (INCLUDING ENTRY LIST)]

Reset all the adjustments and settings for all the signals including the [ENTRY LIST] to the factory preset except [LANGUAGE], [BACKGROUND], [EDGE BLENDING], [MULTI SCREEN], [SCREEN TYPE], [GEOMETRIC CORRECTION], [REF. WHITE BALANCE], [STATIC CONVERGENCE], [ADMINISTRATOR MODE], [CONTROL PANEL LOCK], [SECURITY], [COMMUNICATION SPEED], [DATE AND TIME SETTINGS], [CONTROL ID], [STANDBY MODE], [FAN MODE], [REF. LENS MEMORY], [EDID VERSION], [HDCP VERSION], [LIGHT HOURS USED], [TOTAL CARBON SAVINGS], [WIRED LAN].

Also deletes all the signals in the [ENTRY LIST] and returns to the factory preset.

NOTE: Locked signals in Entry List cannot be reset.

8 Menu Descriptions & Functions [INFO.]

Displays the status of the current signal and light module usage. This item has ten pages. The information included is as follows:

TIP: Pressing the HELP button on the remote control will show the [INFO.] menu items.

[USAGE TIME]



[LIGHT HOURS USED] (H)

[TOTAL CARBON SAVINGS] (kg-CO2)

- [TOTAL CARBON SAVINGS]

This displays the estimated carbon saving information in kg. The carbon footprint factor in the carbon saving calculation is based on the OECD (2008 Edition). (→ page 35)

[SOURCE(1)]

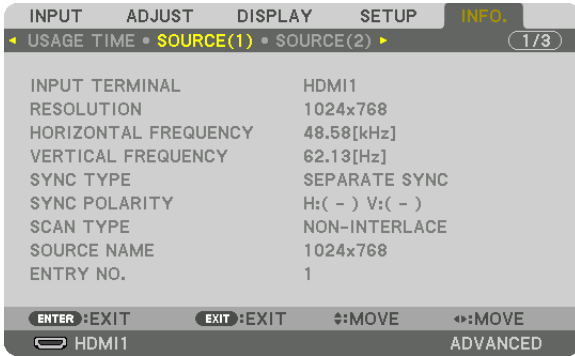

INPUT TERMINAL
 HORIZONTAL FREQUENCY
 SYNC TYPE
 SCAN TYPE
 ENTRY NO.

RESOLUTION
 VERTICAL FREQUENCY
 SYNC POLARITY
 SOURCE NAME

[SOURCE(2)]



SIGNAL TYPE
 VIDEO LEVEL
 3D FORMAT

BIT DEPTH
 SAMPLING FREQUENCY

[SOURCE(3)]

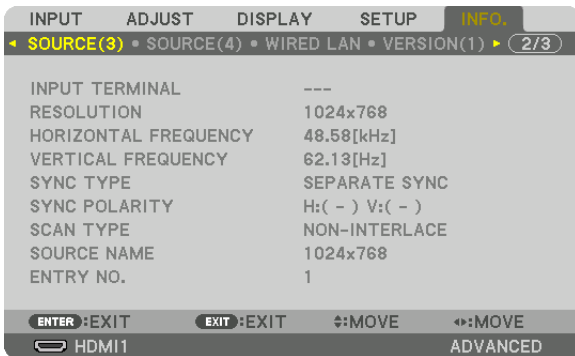

INPUT TERMINAL
 HORIZONTAL FREQUENCY
 SYNC TYPE
 SCAN TYPE
 ENTRY NO.

RESOLUTION
 VERTICAL FREQUENCY
 SYNC POLARITY
 SOURCE NAME

[SOURCE(4)]

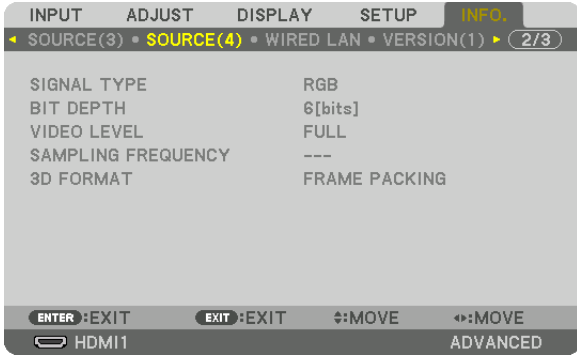

SIGNAL TYPE
VIDEO LEVEL
3D FORMAT

BIT DEPTH
SAMPLING FREQUENCY

[WIRED LAN]



IP ADDRESS
GATEWAY

SUBNET MASK
MAC ADDRESS

[VERSION(1)]



FIRMWARE
FIRMWARE2

DATA

[OTHERS]

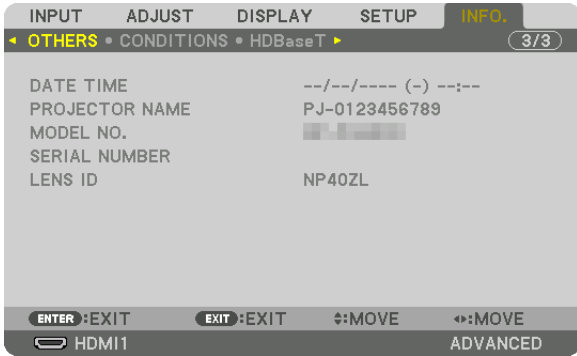

DATE TIME
MODEL NO.
LENS ID

PROJECTOR NAME
SERIAL NUMBER

[CONDITIONS]

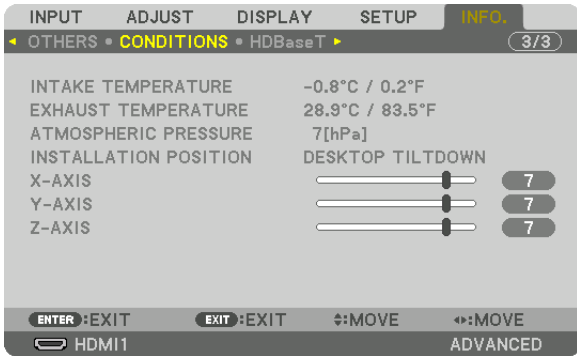

INTAKE TEMPERATURE
ATMOSPHERIC PRESSURE
X-AXIS
Z-AXIS

EXHAUST TEMPERATURE
INSTALLATION POSITION
Y-AXIS

About the X-AXIS, Y-AXIS and Z-AXIS CONDITIONS

* Arrow direction of the Z-AXIS in the figure represents the top of the projector.

X-AXIS..... Display the projector image at an angle of -100 – +100 degrees to the horizontal in the X-axis direction.

X-AXIS value of the projector

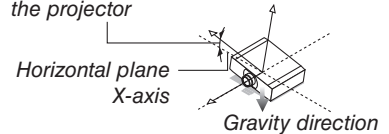

Y-AXIS Display the projector image at an angle of -100 – +100 degrees to the horizontal in the Y-axis direction.

Y-AXIS value of the projector

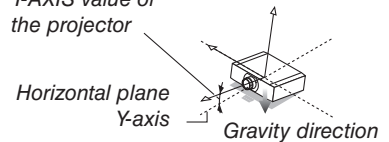

5. Using On-Screen Menu

Z-AXIS Display the projector image at an angle of $-100 - +100$ degrees to the vertical in the Z-axis direction.

Z-AXIS value of the projector

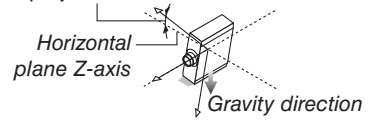

[HDBaseT]

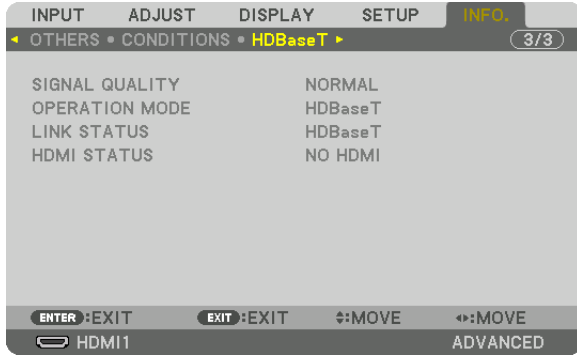

SIGNAL QUALITY
LINK STATUS

OPERATION MODE
HDMI STATUS

6. Connecting to Other Equipment

① Mounting a lens (sold separately)

Three separate bayonet style lenses can be used with this projector. The descriptions here are for the NP41ZL lens. Mount other lenses in the same manner.

⚠ WARNING:

(1) Turn off the power and wait for the cooling fan to stop, (2) disconnect the power cord and wait for the unit to cool before mounting or removing the lens. Failure to do so can result in eye injury, electric shock, or burn injuries.

Important:

- Be sure to carry out [LENS CALIBRATION] after replacing the lens.
- The projector and lenses are made of precision parts. Do not subject them to shock or excessive forces.
- Remove the separately sold lens when moving the projector. If not, the lens could be subject to shock while the projector is being moved, damaging the lens and the lens shift mechanism.
- When dismounting the lens from the projector, return the lens position to the home position before turning off the power. Failure to do so may prevent the lens from being mounted or dismounted because of narrow space between the projector and the lens.
- Never touch the lens surface while the projector is operating.
- Be very careful not to let dirt, grease, etc., on the lens surface and not to scratch the lens surface.
- Perform these operations on a flat surface over a piece of cloth, etc., to prevent the lens from getting scratched.
- When leaving the lens off the projector for long periods of time, mount the dust cap on the projector to prevent dust or dirt from getting inside.

Mounting the lens

1. Remove the dust cap from the projector.

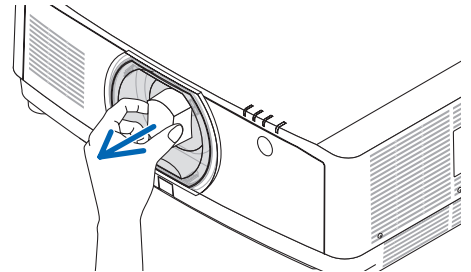

2. Remove the lens cap on the back of the lens.

NOTE:

- Make sure to remove the lens cap at the unit back side. If the lens unit with the lens cap remaining on is installed on the projector, it may cause of malfunction.

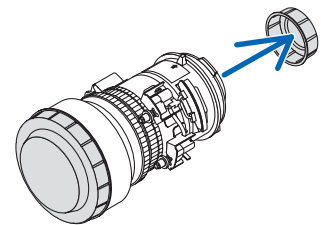

6. Connecting to Other Equipment

- 3. Insert the lens onto the projector facing the arrow on the lens-label upward.**

Insert the lens slowly all the way in.

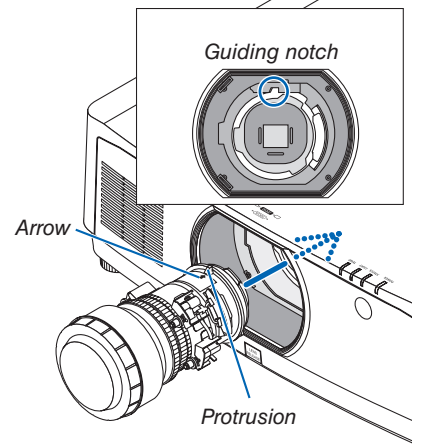

- 4. Turn the lens clockwise.**

Turn until a click is heard.

The lens is now fastened onto the projector.

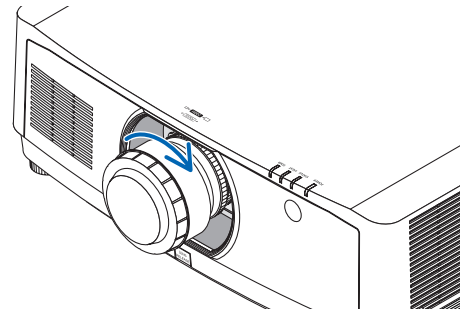

TIP: Mounting the lens theft prevention screw
Fasten the lens theft prevention screw included with the projector to the bottom of the projector so that the lens cannot be removed easily.

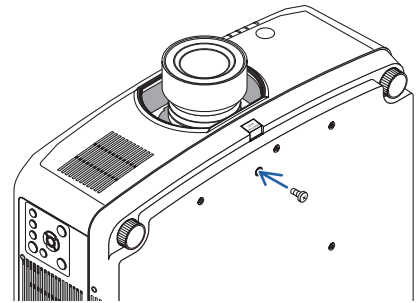

Removing the lens

Preparations:

1. Turn on the projector and display an image.
2. Press and hold the SHIFT/HOME POSITION button over 2 seconds.
The lens position will be moved to the home position.
3. Turn off the main power switch, and then unplug the power cord.
4. Wait until the projector cabinet is cool enough to handle.

If the lens theft prevention screw has been set on, remove it first.

1. While pressing the lens release button at the bottom of lens mounting section on the projector's front panel fully in, turn the lens counterclockwise.

The lens comes off.

NOTE:

- Check the following areas if the lens unit cannot be removed even when the lens release button is pressed.
 1. The lens release button may be locked sometimes. In that case, turn the lens fully to the right. The lens release button lock will be released.

2. Slowly pull the lens off the projector.

- After removing the lens, mount the lens caps (front and back) included with the lens before storing the lens.
- If no lens is going to be mounted on the projector, mount the dust cap included with the projector.

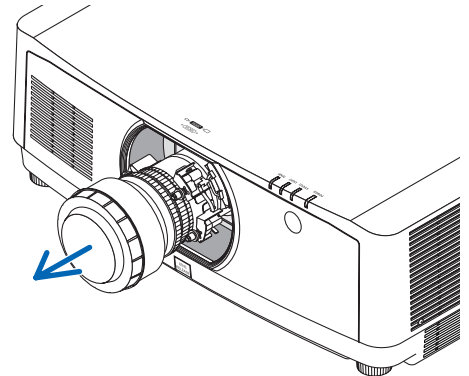
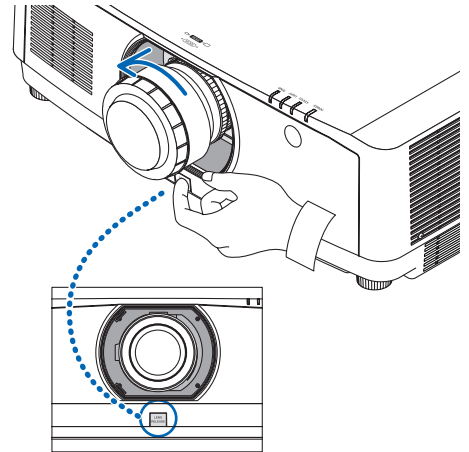

② Making Connections

A computer cable, HDMI cable, or a DisplayPort cable can be used to connect to a computer. The connection cable is not enclosed with the projector. Please get ready a suitable cable for the connection.

Analog RGB signal connection

- Connect the computer cable to the monitor out terminal (mini D-sub 15 pin) on the computer and the computer video input terminal on the projector. Please use a computer cable attached with a ferrite core.

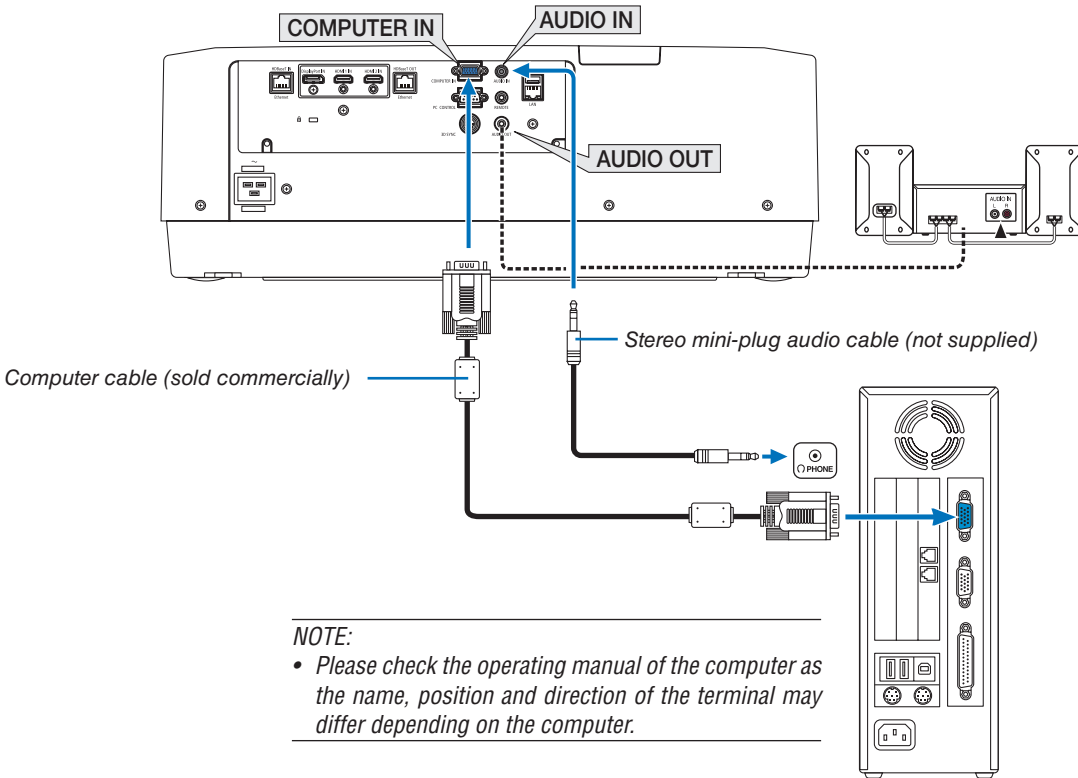

- Select the source name for its appropriate input connector after turning on the projector.



Input connector	INPUT button on the projector cabinet	Button on the remote control
COMPUTER IN	 4:COMPUTER	4/COMPUTER

Digital RGB signal connection

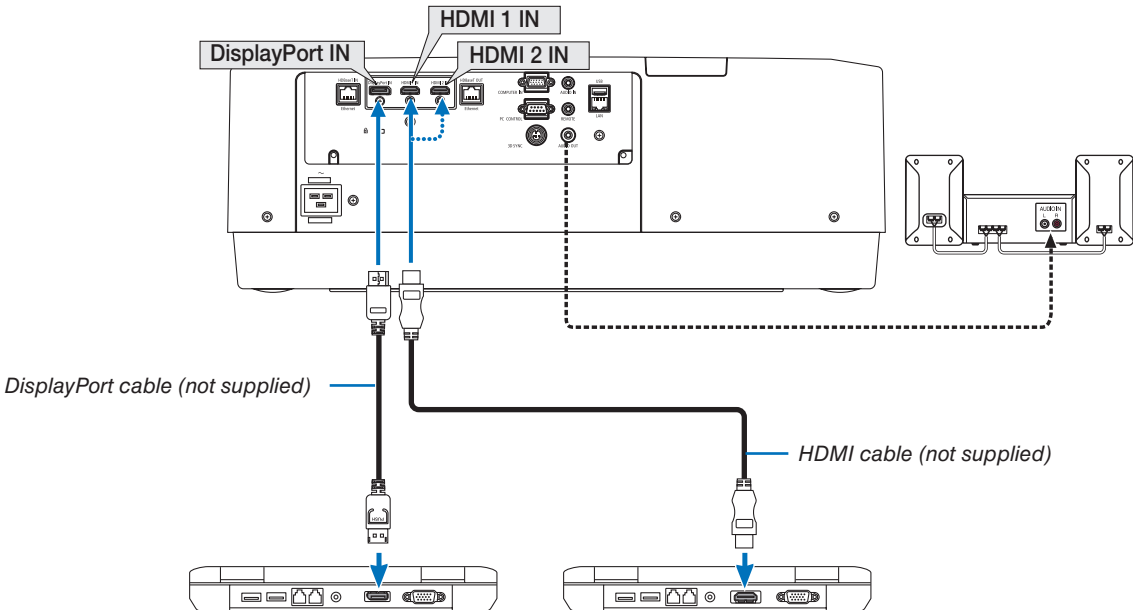
- Connect a commercially available HDMI cable between the computer's HDMI output connector and the projector's HDMI 1 IN or HDMI 2 IN connector.
- Connect a commercially available DisplayPort cable between the computer's DisplayPort output connector and the projector's DisplayPort input connector.



- Select the source name for its appropriate input connector after turning on the projector.

Input connector	INPUT button on the projector cabinet	Button on the remote control
HDMI 1 IN	 1:HDMI 1	1/HDMI 1
HDMI 2 IN	 2:HDMI 2	2/HDMI 2
DisplayPort IN	 3:DisplayPort	3/DisplayPort

Cautions when connecting an HDMI cable

- Use a certified High Speed HDMI® Cable or High Speed HDMI® Cable with Ethernet.

Cautions when connecting a DisplayPort cable

- Use a certified DisplayPort cable.



- Depending on the computer, some time may be required until the image is displayed.
- Some DisplayPort cables (commercially available) have locks.
- To disconnect the cable, press the button on the top of the cable's connector, then pull the cable out.
- In case power supply from the DisplayPort IN terminal is required, please contact your dealer.
- When signals from a device that uses a signal converter adapter are connected to the DisplayPort input connector, in some cases the image may not be displayed.
- When the HDMI output of a computer is connected to the DisplayPort input connector, use a converter (commercially available).

Cautions when using a DVI signal

- When the computer has a DVI output connector, use a commercially available converter cable to connect the computer to the projector's HDMI 1 IN or HDMI 2 IN connector (only digital video signals can be input). Also, connect the computer's audio output to the projector's audio input connector. In this case, switch the HDMI 1 or HDMI 2 setting at on-screen menu's audio selection on the projector to [COMPUTER]. (→ page 128)

To connect the computer's DVI output connector to the projector's DisplayPort input connector, use a commercially available converter.

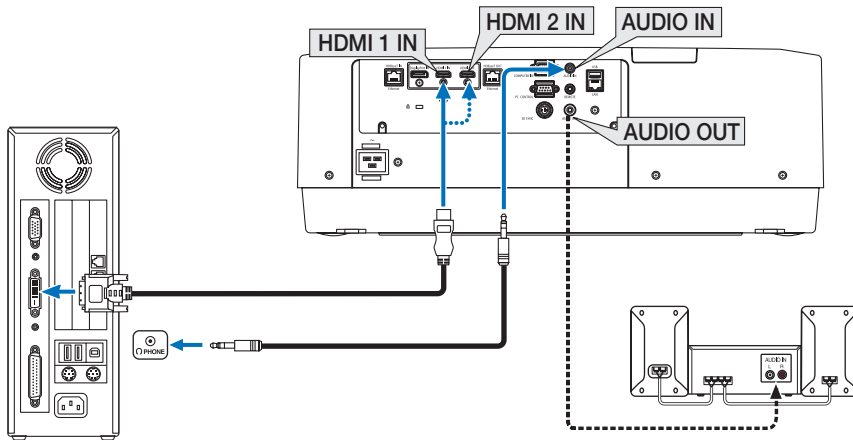

NOTE: When Viewing a DVI Digital Signal

- Turn off the power of the computer and projector before connecting.
- Lower the computer's volume setting before connecting an audio cable to the headphones connector. When using with a computer connected to the projector, adjust the volume of both the projector and computer to set the appropriate volume level.
- If the computer has a mini-jack type audio output connector, we recommend connecting the audio cable to that connector.
- When a video deck is connected via a scan converter, etc., the display may not be correct during fast-forwarding and rewinding.
- Use a DVI-to-HDMI cable compliant with DDWG (Digital Display Working Group) DVI (Digital Visual Interface) revision 1.0 standard. The cable should be within 197"/5 m long.
- Turn off the projector and the PC before connecting the DVI-to-HDMI cable.
- To project a DVI digital signal: Connect the cables, turn the projector on, then select the HDMI input. Finally, turn on your PC. Failure to do so may not activate the digital output of the graphics card resulting in no picture being displayed. Should this happen, restart your PC.
- Some graphics cards have both analog RGB (15-pin D-Sub) and DVI (or DFP) outputs. Use of the 15-pin D-Sub connector may result in no picture being displayed from the digital output of the graphics card.
- Do not disconnect the DVI-to-HDMI cable while the projector is running. If the signal cable has been disconnected and then reconnected, an image may not be correctly displayed. Should this happen, restart your PC.
- The COMPUTER video input connectors support Windows Plug and Play.
- A Mac signal adapter (commercially available) may be required to connect a Mac computer.
To connect a Mac computer equipped with a Mini DisplayPort to the projector, use a commercially available Mini DisplayPort → DisplayPort converter cable.

Connecting Component Input

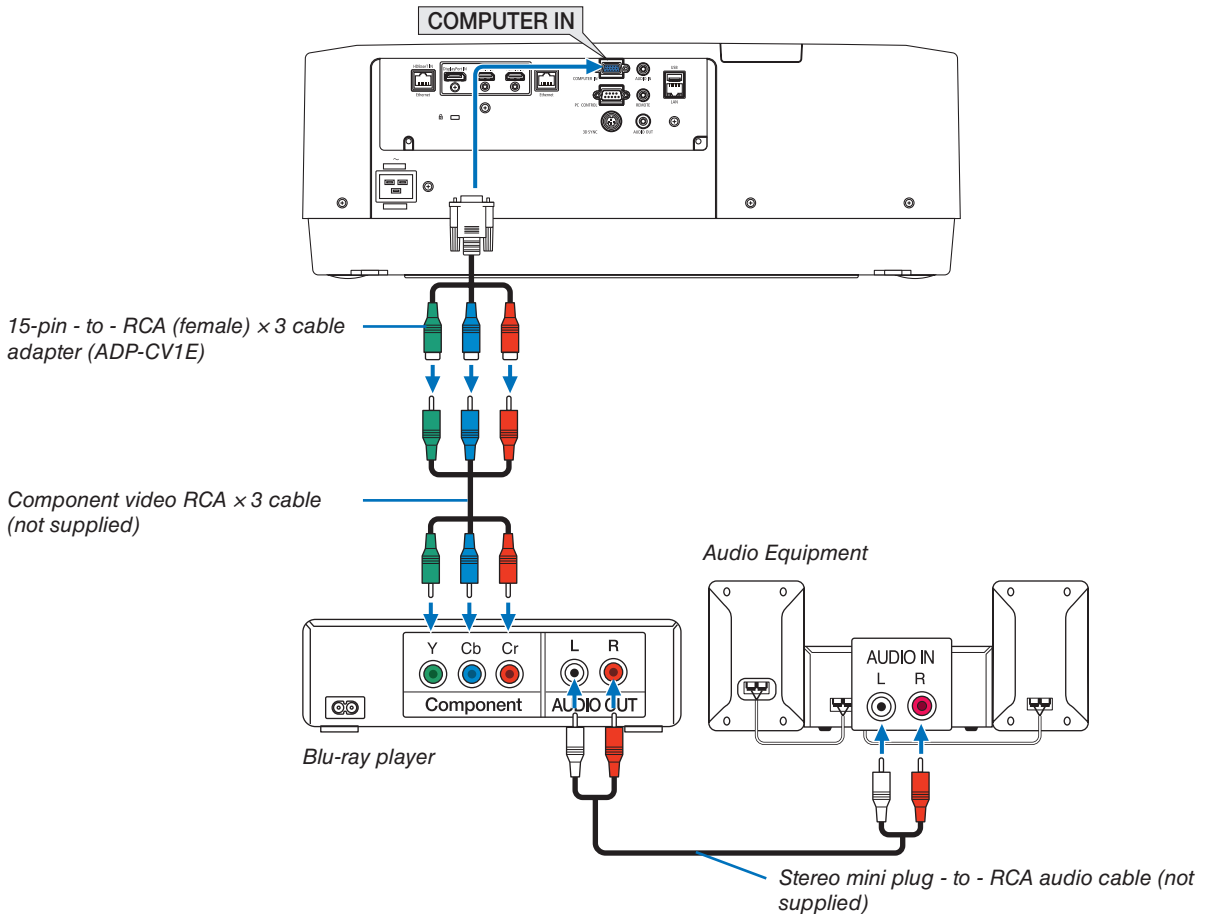

- Select the source name for its appropriate input connector after turning on the projector.

Input connector	INPUT button on the projector cabinet	Button on the remote control
COMPUTER IN	4:COMPUTER	4/COMPUTER



NOTE:

- When the signal format is set to [AUTO] (default factory setting when shipped), the computer signal and component signal are automatically distinguished and switched. If the signals cannot be distinguished, select [COMPONENT] under [ADJUST] → [VIDEO] → [SIGNAL TYPE] in the on-screen menu of the projector.
- To connect to a video device with a D connector, use the sold separately D connector converter adapter (model ADP-DT1E).

Connecting HDMI Input

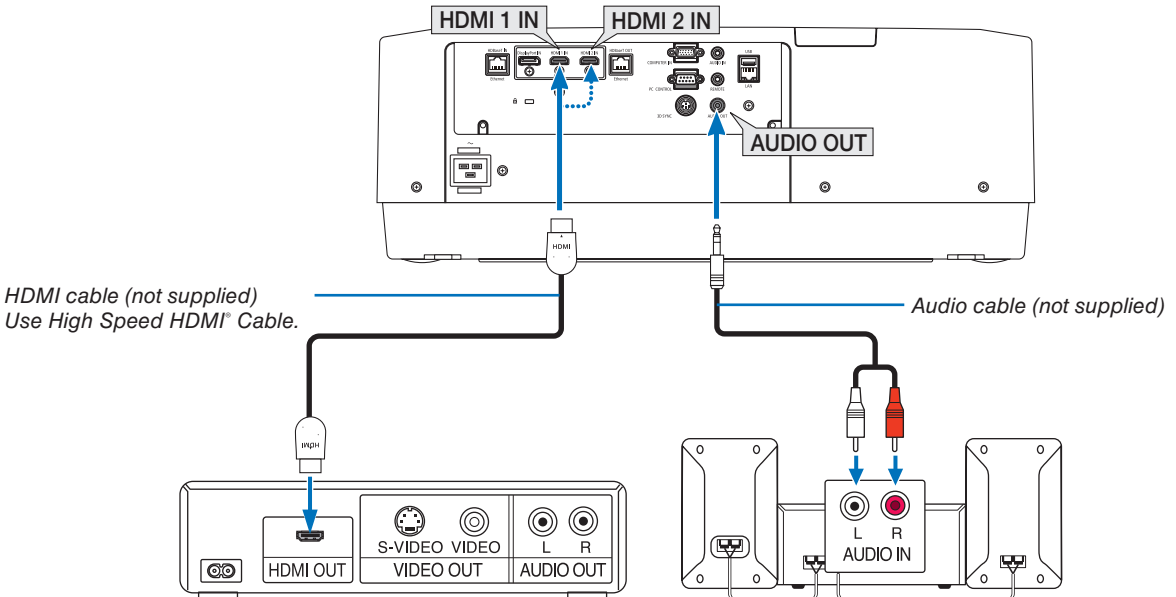
You can connect the HDMI output of your Blu-ray player, hard disk player, or notebook type PC to the HDMI 1 IN or HDMI 2 IN connector of your projector.



Input connector	INPUT button on the projector cabinet	Button on the remote control
HDMI 1 IN	 1:HDMI 1	1/HDMI 1
HDMI 2 IN	 2:HDMI 2	2/HDMI 2

TIP: For users of audio video equipment with an HDMI connector:

Select "Enhanced" rather than "Normal" if HDMI output is switchable between "Enhanced" and "Normal".

This will provide improved image contrast and more detailed dark areas.

For more information on settings, refer to the instruction manual of the audio video equipment to be connected.

- When connecting the HDMI 1 IN or HDMI 2 IN connector of the projector to the Blu-ray player, the projector's video level can be made settings in accordance with the Blu-ray player's video level. In the menu select [ADJUST] → [VIDEO] → [VIDEO LEVEL] and make necessary settings.
- If the HDMI input's sound is not output, check if [HDMI1] and [HDMI2] are set [HDMI1] and [HDMI2] correctly the on-screen menu [SETUP] → [SOURCE OPTIONS] → [AUDIO SELECT]. (→ page 128)

Connecting to a HDBaseT transmission device (sold commercially)

Use a LAN cable sold commercially to connect the HDBaseT IN/Ethernet port of the projector (RJ-45) to a HDBaseT transmission device sold commercially.

The HDBaseT IN/Ethernet port of the projector supports HDMI signals (HDCP) from transmission devices, control signals from external devices (serial, LAN) and remote control signals (IR commands).

- Refer to the owner's manual accompanied with your HDBaseT transmission for connecting with your external devices.

Connection example

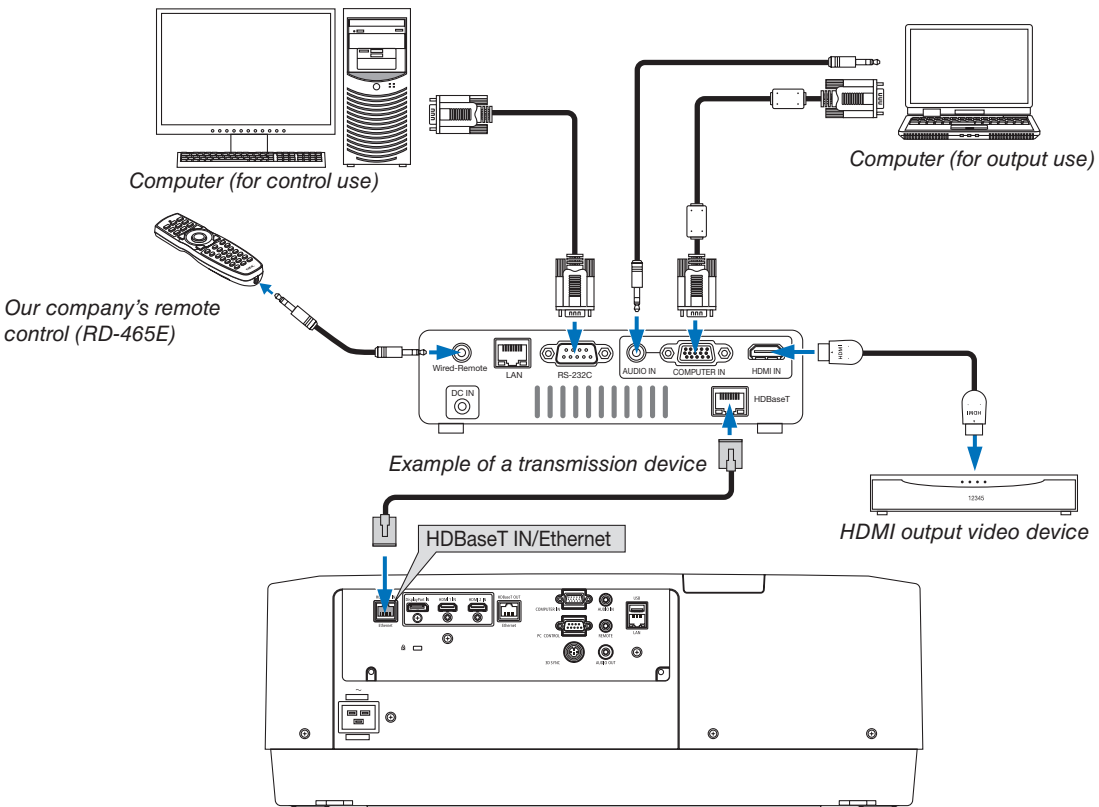

NOTE:

- Please use a shielded twisted pair (STP) cable of Category 5e or higher for the LAN cable (sold commercially).
- The maximum transmission distance over the LAN cable is 100 m. (the maximum distance is 70 m for a 4K signal)
- Please do not use other transmission equipment between the projector and transmission equipment. The picture quality may be degraded as a result.
- This projector is not guaranteed to work with all HDBaseT transmission devices sold commercially.

Connecting several projectors

It enables to project HDMI, DisplayPort, HDBaseT image on several projectors connecting the HDBaseT IN/Ethernet port and the HDBaseT OUT/Ethernet port by LAN cable. The projectors support same brightness can be connected up to four units,

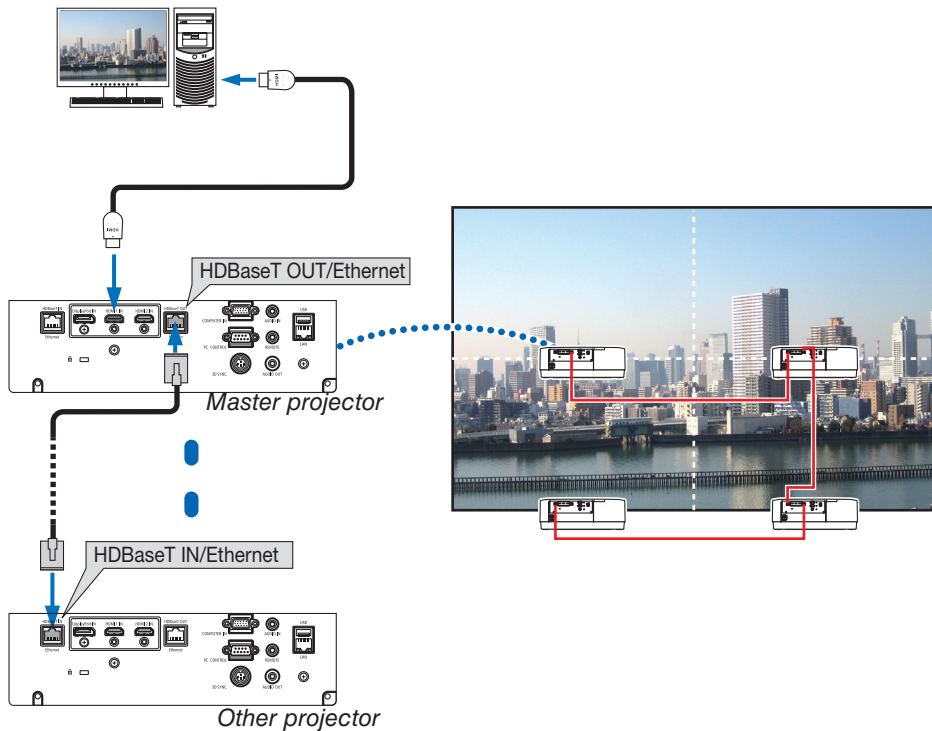

- The signal from the COMPUTER IN terminal is not output from the HDBaseT OUT/Ethernet port of this projector.
- PA803UL and PA653UL cannot be connected. At the same time, this projector is not guaranteed to work correctly in the connection with an other device as a monitor.
- When outputting HDMI signals, turn on the power of the video device on the output side and keep it connected before inputting video signals into this device. The HDMI output terminals of the projector are equipped with repeater functions. When a device is connected to the HDMI output terminal, the resolution of the output signal is limited by the resolution supported by the connected device.
- Connecting and disconnecting an HDMI cable or selecting another input source on the second and subsequent projectors will disable the HDMI repeater function.

Portrait projection (vertical orientation)

Portrait screens from a computer can be projected by installing the projector in a vertical orientation. Angle to display all the screens such as the on-screen menu can be changed by the menu [SETUP] → [MENU(2)] → [MENU ANGLE].

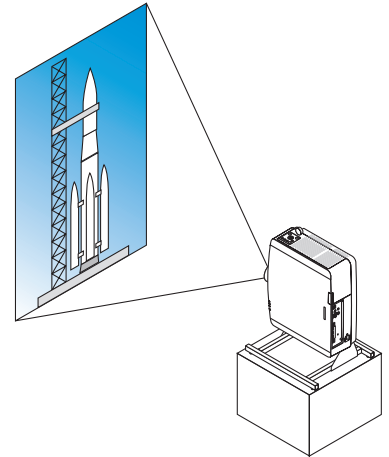

Precautions during installation

- Please do not install the projector in a vertical orientation on top of the floor or table on its own. The intake vent may be obstructed, resulting in the projector getting warm and the possibility of fire and malfunction occurring.
- A stand for supporting the projector needs to be made for portrait projection and for installing the projector in universal angle. In this case, the stand must be designed such that the center of gravity of the projector is located well within the legs of the stand. If not, the projector may fall over and result in injury, damage and malfunction.

Design and manufacturing conditions for the stand

Please engage an installation service provider for the design and manufacture of the customized stand to be used for portrait projection. Please ensure that the following are complied with when designing the stand.

1. Secure sufficient space between the projector and the floor:
 - * Installation facing the intake vent downward: 130 mm or greater.
Installation facing the exhaust vent downward: 200 mm or greater.
2. Use the four screw holes at the back of the projector to secure it to the stand.
Screw hole center dimension: 200 × 250 mm
Screw hole dimension on the projector: M4 with a maximum depth of 8 mm.
 - * Please design the stand such that the rear legs at the back of the projector do not contact the stand. The front legs can be turned and removed.
3. Horizontal adjustment mechanism (for example, bolts and nuts in four locations)
4. Please design the stand such that it does not topple over easily.

Reference drawings

* The drawing showing the dimensional requirements is not an actual stand design drawing.

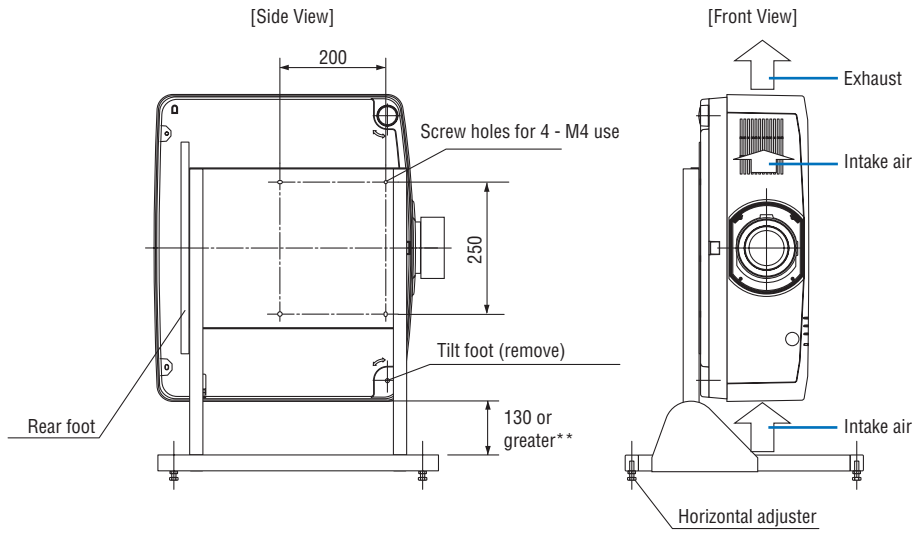

** Please refer to the previous page.

Connecting to a Wired LAN

The projector comes standard with a LAN port (RJ-45) which provides a LAN connection using a LAN cable. To use a LAN connection, you are required to set the LAN on the projector menu. Select [SETUP] → [NETWORK SETTINGS] → [WIRED LAN]. (→ page 124).

Example of LAN connection

Example of wired LAN connection

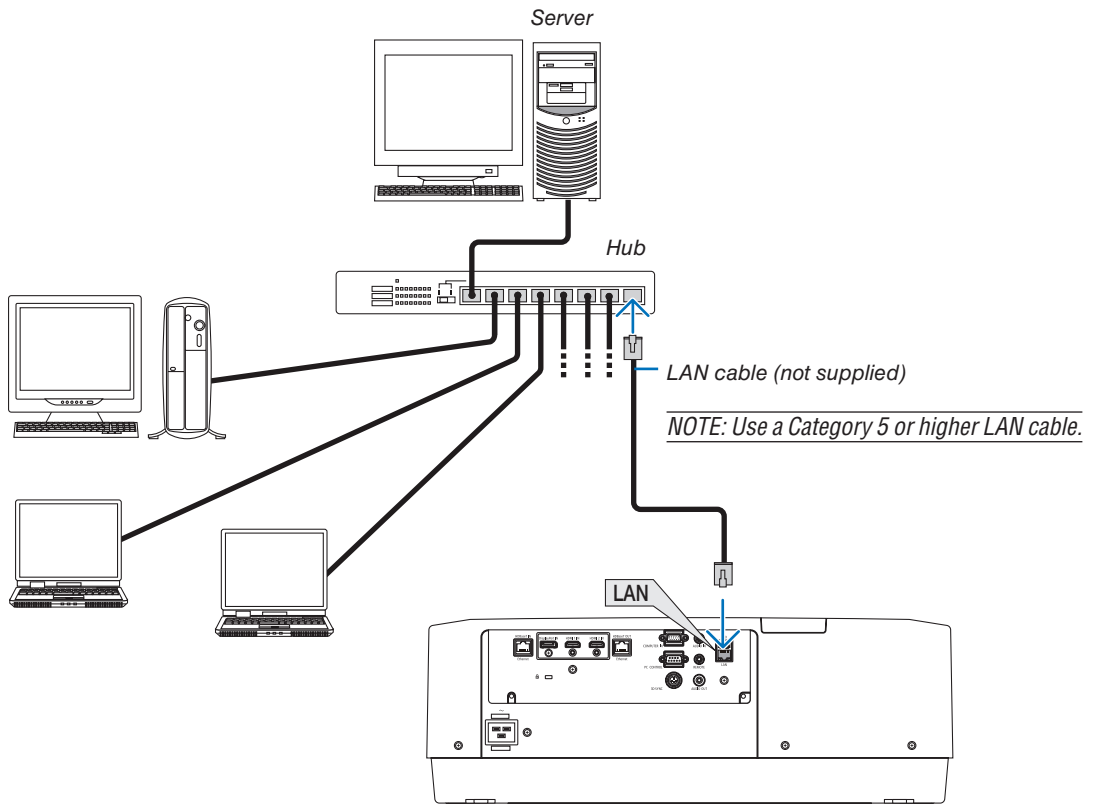

7. Maintenance

WARNING

- Please do not use a spray containing flammable gas to remove dust attached to the lens and cabinet. Doing so may result in fires.

① Cleaning the Lens

- Turn off the projector before cleaning.
- The projector has a plastic lens. Use a commercially available plastic lens cleaner.
- Do not scratch or mar the lens surface as a plastic lens is easily scratched.
- Never use alcohol or glass lens cleaner as doing so will cause damage to the plastic lens surface.

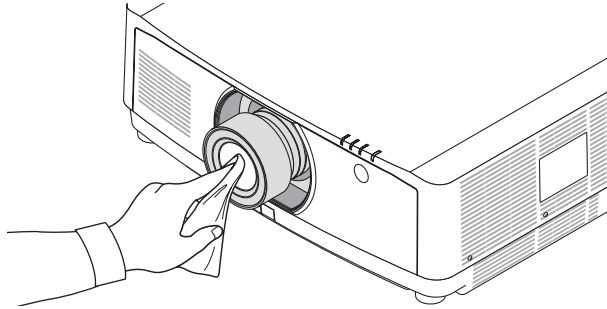

② Cleaning the Cabinet

Turn off the projector, and unplug the projector before cleaning.

- Use a dry soft cloth to wipe dust off the cabinet.
If heavily soiled, use a mild detergent.
- Never use strong detergents or solvents such as alcohol or thinner.
- When cleaning the ventilation slits or the speaker using a vacuum cleaner, do not force the brush of the vacuum cleaner into the slits of the cabinet.

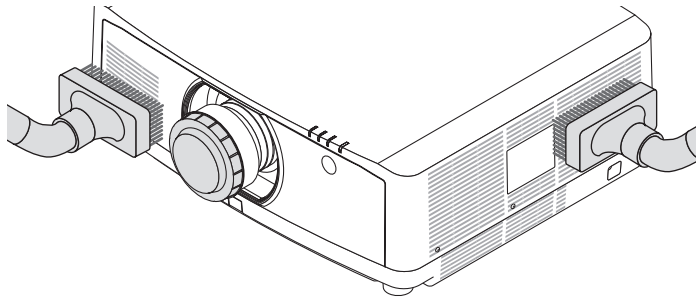

Vacuum the dust off the ventilation slits.

- Clogged ventilation slits may cause a rise in the internal temperature of the projector, resulting in malfunction.
- Do not scratch or hit the cabinet with your fingers or any hard objects
- Contact your dealer for cleaning the inside of the projector.

NOTE: Do not apply volatile agent such as insecticide on the cabinet, the lens, or the screen. Do not leave a rubber or vinyl product in prolonged contact with it. Otherwise the surface finish will be deteriorated or the coating may be stripped off.

8. Appendix

① Throw distance and screen size

Three separate bayonet style lenses can be used on this projector. Refer to the information on this page and use a lens suited for the installation environment (screen size and throw distance). For instructions on mounting the lens, see page 138.

Lens types and throw distance

Screen size (inches)	Lens model name					
	NP40ZL		NP41ZL		NP42ZL	
	(inches)	(m)	(inches)	(m)	(inches)	(m)
50	33 - 46	0.8 - 1.2	54 - 127	1.4 - 3.2	125 - 245	3.2 - 6.2
60	39 - 56	1.1 - 1.4	66 - 153	1.7 - 3.9	149 - 293	3.8 - 7.4
80	53 - 75	1.4 - 1.9	88 - 204	2.2 - 5.2	197 - 389	5.0 - 9.9
100	67 - 94	1.7 - 2.4	110 - 256	2.8 - 6.5	245 - 485	6.2 - 12.3
120	81 - 114	2.0 - 2.9	133 - 307	3.4 - 7.8	292 - 581	7.4 - 14.8
150	101 - 142	2.6 - 3.6	166 - 384	4.2 - 9.8	364 - 725	9.3 - 18.4
200	135 - 190	3.4 - 4.8	223 - 513	5.7 - 13.0	484 - 965	12.3 - 24.5
240	163 - 229	4.1 - 5.8	267 - 616	6.8 - 15.6	580 - 1157	14.7 - 29.4
300	204 - 286	5.2 - 7.3	335 - 770	8.5 - 19.6	723 - 1446	18.4 - 36.7
400	272 - 382	6.9 - 9.7	447 - 1028	11.4 - 26.1	963 - 1926	24.5 - 48.9
500	340 - 478	8.6 - 12.1	559 - 1285	14.2 - 32.6	1202 - 2407	30.5 - 61.1

TIP

Calculation of the throw distance from the screen size

NP40ZL lens throw distance (inch/m) = $H \times 0.8$ to $H \times 1.1$: 33"/0.8 m (min.) to 478"/12.1 m (max.)

NP41ZL lens throw distance (inch/m) = $H \times 1.3$ to $H \times 3.0$: 54"/1.4 m (min.) to 1285"/32.6 m (max.)

NP42ZL lens throw distance (inch/m) = $H \times 2.9$ to $H \times 5.7$: 125"/3.2 m (min.) to 2407"/61.1 m (max.)

"H" (Horizontal) refers to the screen width.

* Figures differ by several % with the table above because the calculation is approximate.

Ex.: Throw distance when projecting on a 150" screen using the NP41ZL lens:

According to the "Screen Size (for reference)" table (→ page 153), H (screen width) = 127.2"/323.1 cm.

The throw distance is $127.2"/323.1 \text{ cm} \times 1.3$ to $127.2"/323.1 \text{ cm} \times 3.0 = 165"/420.0 \text{ cm}$ to $382"/969.3 \text{ cm}$ (because of the zoom lens).

Projection range for the different lenses

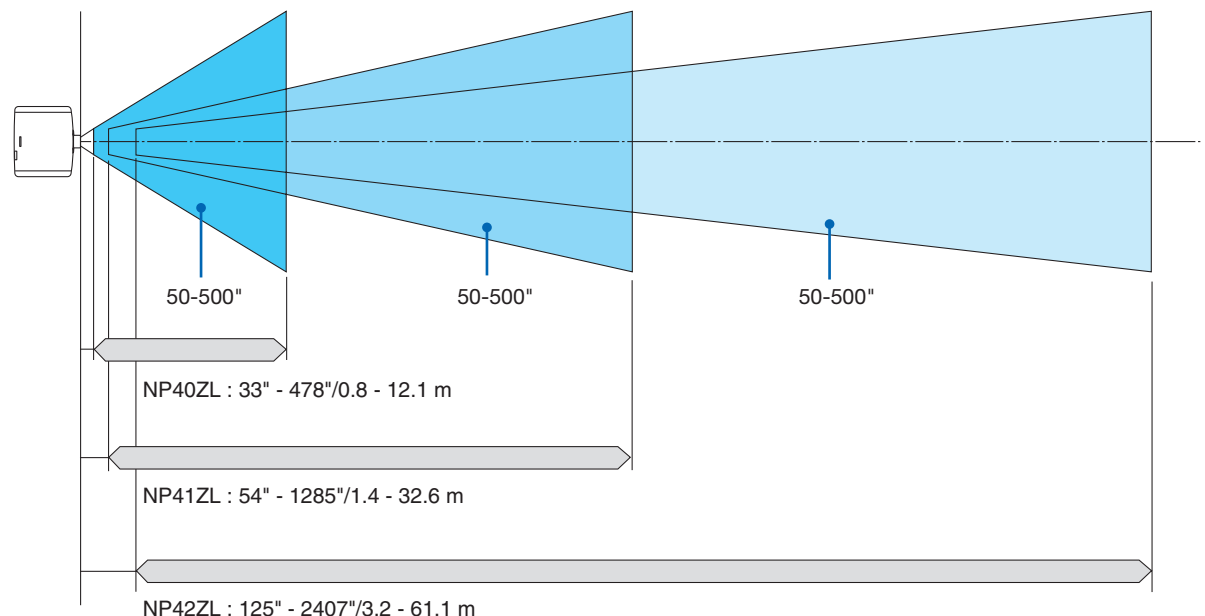

Tables of screen sizes and dimensions

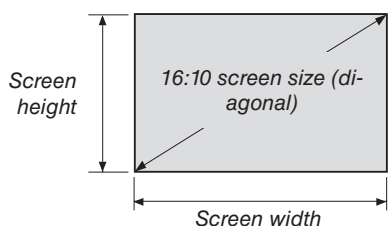

Size (inches)	Screen width		Screen height	
	(inches)	(cm)	(inches)	(cm)
50	42.4	107.7	26.5	67.3
60	50.9	129.2	31.8	80.8
80	67.8	172.3	42.4	107.7
100	84.8	215.4	53.0	134.6
120	101.8	258.5	63.6	161.5
150	127.2	323.1	79.5	201.9
200	169.6	430.8	106.0	269.2
240	203.5	516.9	127.2	323.1
300	254.4	646.2	159.0	403.9
400	339.2	861.6	212.0	538.5
500	424.0	1077.0	265.0	673.1

Lens shifting range

This projector is equipped with a lens shift function for adjusting the position of the projected image by buttons. The lens can be shifted within the range shown below.

Desk/front projection

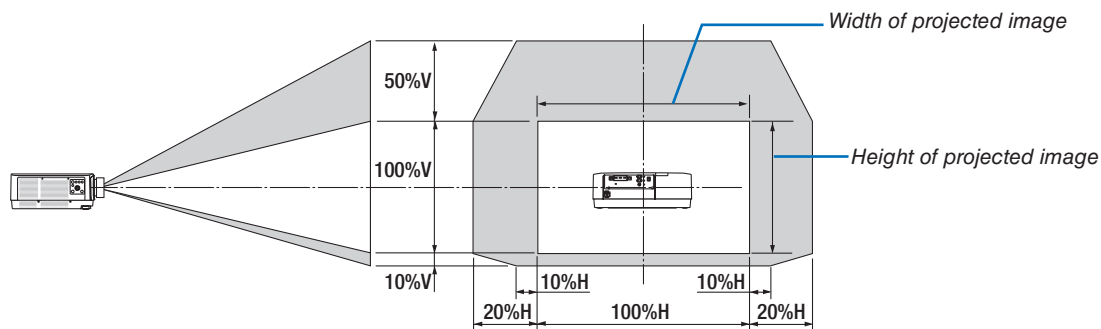

Description of symbols: V indicates vertical (height of the projected image), H indicates horizontal (width of the projected image).

Ceiling/front projector

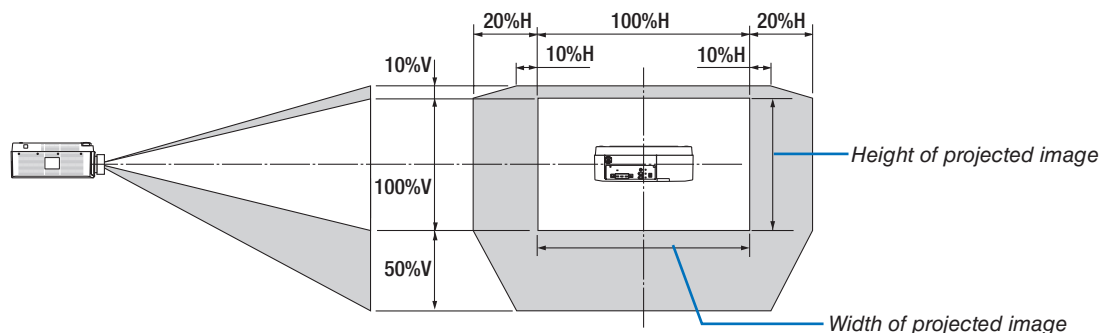

Example: When projecting on a 150" screen

According to the tables of screen sizes and dimensions (→ page 153), $H = 127.2''$ (323.1 cm), $V = 79.5''$ (201.9 cm). Adjustment range in the vertical direction: The projected image can be moved upwards $0.5 \times 79.5''$ (201.9 cm) $\approx 39.6''$ (101 cm), downwards $0.1 \times 79.5''$ (201.9 cm) $\approx 8''$ (20 cm) (when the lens is at the center position). For a ceiling/front installation, the above figures are inverted.

Adjustment range in the horizontal direction: The projected image can be moved to the left $0.2 \times 127.2''$ (323.1 cm) $\approx 25.5''$ (64.5 cm), to the right $0.2 \times 127.2''$ (323.1 cm) $\approx 25.5''$ (64.5 cm).

* Figures differ by several % because the calculation is approximate.

② Compatible Input Signal List

HDMI/HDBaseT

Signal	Resolution (dots)	Aspect Ratio	Refresh Rate (Hz)
VGA	640 × 480	4 : 3	60/72/75/85/iMac
SVGA	800 × 600	4 : 3	56/60/72/75/85/iMac
XGA	1024 × 768	4 : 3	60/70/75/85/iMac
HD	1280 × 720	16 : 9	60
WXGA	1280 × 768	15 : 9	60
	1280 × 800	16 : 10	60
Quad-VGA	1280 × 960	4 : 3	60
SXGA	1280 × 1024	5 : 4	60
FWXGA	1366 × 768	16 : 9	60
	1366 × 768	16 : 9	60
SXGA+	1400 × 1050	4 : 3	60
WXGA+	1440 × 900	16 : 10	60
WXGA++	1600 × 900	16 : 9	60
WSXGA+	1680 × 1050	16 : 10	60
UXGA	1600 × 1200 *	4 : 3	60
Full HD	1920 × 1080 *	16 : 9	60
WUXGA	1920 × 1200 *	16 : 10	60 (Reduced Blanking)
2K	2048 × 1080	17 : 9	60
WQHD iMac 27"	2560 × 1440	16 : 9	60
WQXGA	2560 × 1600	16 : 10	60 (Reduced Blanking)
4K	3840 × 2160	16 : 9	24/25/30/50/60
	4096 × 2160	17 : 9	24/25/30/50/60
HDTV(1080p)	1920 × 1080 *	16 : 9	24/25/30/50/60
HDTV(1080i)	1920 × 1080 *	16 : 9	48/50/60
HDTV (720p)	1280 × 720	16 : 9	50/60
SDTV (480p)	720/1440 × 480	4:3 / 16:9	60
SDTV (576p)	720/1440 × 576	4:3 / 16:9	50
SDTV (480i)	1440 × 480	4:3 / 16:9	60
SDTV (576i)	1440 × 576	4:3 / 16:9	50

DisplayPort

Signal	Resolution (dots)	Aspect Ratio	Refresh Rate (Hz)
VGA	640 × 480	4 : 3	60
SVGA	800 × 600	4 : 3	60
XGA	1024 × 768	4 : 3	60
HD	1280 × 720	16 : 9	60
WXGA	1280 × 768	15 : 9	60
	1280 × 800	16 : 10	60
Quad-VGA	1280 × 960	4 : 3	60
SXGA	1280 × 1024	5 : 4	60
FWXGA	1366 × 768	16 : 9	60
	1366 × 768	16 : 9	60
SXGA+	1400 × 1050	4 : 3	60
WXGA+	1440 × 900	16 : 10	60
WXGA++	1600 × 900	16 : 9	60
WSXGA+	1680 × 1050	16 : 10	60
UXGA	1600 × 1200 *	4 : 3	60
Full HD	1920 × 1080 *	16 : 9	60
WUXGA	1920 × 1200 *	16 : 10	60 (Reduced Blanking)
2K	2048 × 1080	17 : 9	60
WQHD iMac 27"	2560 × 1440	16 : 9	60
WQXGA	2560 × 1600	16 : 10	60 (Reduced Blanking)
4K	3840 × 2160	16 : 9	24/25/30/50/60
	4096 × 2160	17 : 9	24/25/30/50/60
HDTV(1080p)	1920 × 1080	16 : 9	24/25/30/50/60
HDTV (720p)	1280 × 720	16 : 9	50/60
SDTV (480i/p)	720/1440 × 480	4:3 / 16:9	60
SDTV (576i/p)	720/1440 × 576	4:3 / 16:9	50

Analog RGB

Signal	Resolution (dots)	Aspect Ratio	Refresh Rate (Hz)
VGA	640 × 480	4 : 3	60/72/75/85/iMac
SVGA	800 × 600	4 : 3	56/60/72/75/85/iMac
XGA	1024 × 768	4 : 3	60/70/75/85/iMac
XGA+	1152 × 864	4 : 3	75
HD	1280 × 720	16 : 9	60
WXGA	1280 × 768	15 : 9	60/75/85
	1280 × 800	16 : 10	60/75/85
Quad-VGA	1280 × 960	4 : 3	60/85
SXGA	1280 × 1024	5 : 4	60/75/85
FWXGA	1366 × 768	16 : 9	60
	1366 × 768	16 : 9	60
SXGA+	1400 × 1050	4 : 3	60/75
WXGA+	1440 × 900	16 : 10	60/75/85
WXGA++	1600 × 900	16 : 9	60
UXGA	1600 × 1200 *	4 : 3	60
WSXGA+	1680 × 1050	16 : 10	60
Full HD	1920 × 1080 *	16 : 9	60
WUXGA	1920 × 1200 *	16 : 10	60 (Reduced Blanking)
2K	2048 × 1080	17 : 9	60
Full HD	1920 × 1080 *	16 : 9	60
MAC 13"	640 × 480	4 : 3	67
MAC 16"	832 × 624	4 : 3	75
MAC 19"	1024 × 768	4 : 3	75
MAC 21"	1152 × 870	4 : 3	75
MAC 23"	1280 × 1024	5 : 4	65

Analog Component

Signal	Resolution (dots)	Aspect Ratio	Refresh Rate (Hz)
HDTV (1080p)	1920 × 1080	16 : 9	50/60
HDTV (1080i)	1920 × 1080	16 : 9	48/50/60
HDTV (720p)	1280 × 720	16 : 9	50/60
SDTV (480p)	720 × 480	4:3 / 16:9	60
SDTV (576p)	720 × 576	4:3 / 16:9	50
SDTV (480i)	720 × 480	4:3 / 16:9	60
SDTV (576i)	720 × 576	4:3 / 16:9	50

HDMI/HDBaseT 3D

Signal Resolution (dots)	Aspect Ratio	Refresh Rate (Hz)	3D Format
1920 × 1080p	16 : 9	23.98/24	Frame Packing
			Side By Side (Half)
			Top And Bottom
		25	Side By Side (Half)
			Top And Bottom
29.97/30		Frame Packing	
		Side By Side (Half)	
50		Side By Side (Half)	
		Top And Bottom	
59.94/60		Side By Side (Half)	
		Top And Bottom	
1920 × 1080i		50	Side By Side (Half)
			Top And Bottom
1280 × 720p		59.94/60	Side By Side (Half)
			Top And Bottom
	23.98/24	Frame Packing	
		Side By Side (Half)	
		Top And Bottom	
	25	Side By Side (Half)	
		Top And Bottom	
	29.97/30	Frame Packing	
		Side By Side (Half)	
	50	Top And Bottom	
Frame Packing			
59.94/60	Side By Side (Half)		
	Top And Bottom		

DisplayPort 3D

Signal Resolution (dots)	Aspect Ratio	Refresh Rate (Hz)	3D Format
1920 × 1080p	16 : 9	23.98/24	Frame Packing
			Side By Side (Half)
			Top And Bottom
		25	Side By Side (Half)
			Top And Bottom
29.97/30		Frame Packing	
		Side By Side (Half)	
50		Side By Side (Half)	
		Top And Bottom	
59.94/60		Side By Side (Half)	
		Top And Bottom	
1280 × 720p		23.98/24	Frame Packing
			Side By Side (Half)
		25	Top And Bottom
			Side By Side (Half)
	29.97/30	Frame Packing	
		Side By Side (Half)	
	50	Top And Bottom	
		Frame Packing	
	59.94/60	Side By Side (Half)	
		Top And Bottom	

* Native resolution

- Signals exceeding the projector's resolution are handled with Advanced AccuBlend.
- With Advanced AccuBlend, the size of characters and ruled lines may be uneven and colors may be blurred.
- Upon shipment, the projector is set for signals with standard display resolutions and frequencies, but adjustments may be required depending on the type of computer.

③ Specifications

Model name		PA803UL/PA653UL
Method		Three primary color liquid crystal shutter projection method
Specifications of main parts		
Liquid crystal panel	Size	0.76" (with MLA) × 3 (aspect ratio: 16:10)
	Pixels ^(*)	2,304,000 (1920 dots × 1200 lines)
Projection lenses		Refer to the specifications of option lens (→ 160 page)
Light source		Laser diode
Optical device		Integrator, Dichroic Mirror, XDP
Light output ^(*) ^(*)	ECO OFF	PA803UL: 8000 lm PA653UL: 6500 lm
Contrast ratio ^(*) (all white/all black)		2500000:1 with dynamic contrast
Screen size (throw distance)		50" to 500"
Color reproducibility		10-bit color processing (approx. 1.07 billion colors)
Scanning frequency	Horizontal	Analog: 15 kHz, 24 to 100 kHz (24 kHz or greater for RGB inputs), conforming to VESA standards Digital: 15 kHz, 24 to 153 kHz, conforming to VESA standards
	Vertical	Analog: 48 Hz, 50 to 85 Hz, 100, 120 Hz conforming to VESA standards Digital: 24, 25, 30, 48 Hz, 50 to 85 Hz, 100, 120 Hz conforming to VESA standards
Main adjustment functions		Motorized Zoom, Motorized Focus, Motorized Lens Shift, input signal switching (HDMI1/HDMI2/DisplayPort/COMPUTER/HDBaseT), auto image adjustment, picture enlarging, picture position adjustment, muting (both video and audio), power on/standby, on-screen display/selection, etc.
Max. display resolution (horizontal × vertical)		Analog WUXGA (1920 × 1200) with Advanced AccuBlend Pixel clock frequency: less than 165 MHz Digital Quad HD (4096 × 2160) with Advanced AccuBlend Pixel clock frequency: less than 600 MHz (HDBaseT: 300 MHz)
Input signals		
R,G,B,H,V		RGB: 0.7Vp-p/75Ω
		Y: 1.0Vp-p/75Ω (with Negative Polarity Sync)
		Cb, Cr (Pb, Pr): 0.7Vp-p/75Ω
		H/V Sync: 4.0Vp-p/TTL
		Composite Sync: 4.0Vp-p/TTL
Component		Sync on G: 1.0Vp-p/75Ω (with Sync)
		Y: 1.0Vp-p/75Ω (with Sync)
		Cb, Cr (Pb, Pr): 0.7Vp-p/75Ω
		DTV: 480i, 480p, 720p, 1080i, 1080p (60Hz) 576i, 576p, 720p, 1080i (50Hz)
Audio		DVD: Progressive signal (50/60Hz) 0.5Vrms/22kΩ or greater
Input/output connectors		
Computer/Component	Video input	Mini D-Sub 15-pin × 1
	Audio input	Stereo mini jack × 1
	Audio output	Stereo mini jack × 1 (common for all signals)
HDMI	Video input	HDMI® Connector type A × 2 RJ-45 × 1, 100BASE-TX compatible Deep Color (color depth): 8-/10-/12-bit compatible Colorimetry: RGB, YCbCr444, YCbCr422, YCbCr420, REC2020, REC709, REC601 Supports LipSync, HDCP ^(*) , 4K HDR and 3D
	Audio input	HDMI: Sampling frequency – 32/44.1/48 kHz, Sampling bits – 16/20/24 bits
HDBaseT/Ethernet	Video input	Deep Color (color depth): Support 8/10/12 bits Colorimetry: Support RGB, YCbCr444, YCbCr422, YCbCr420, REC2020, REC709, REC601 Support LipSync, HDCP ^(*) , 4K, 3D, HDR
	Video output	RJ-45x1, 100BASE-TX Deep Color (color depth): Support 8/10/12 bits Colorimetry: Support RGB, YCbCr444, YCbCr422, REC709, REC601 Support LipSync, HDCP ^(*) , 4K, 3D
	Audio input	Sampling frequency: 32/44.1/48 kHz Sampling bit: 16/20/24 bit
	Audio output	Sampling frequency: 32/44.1/48 kHz Sampling bit: 16/20/24 bits

Model name			PA803UL/PA653UL	
DisplayPort	Video input	DisplayPort × 1 Data rate: 5.4 Gbps/2.7Gbps/1.62Gbps No. lanes: 1 lane/2 lanes/4 lanes Color depth: 8 bits, 10bits, 12bits Colorimetry: RGB, YCbCr444, YCbCr422, REC709, REC601 HDCP compatible ^{(*)4}		
		Audio input	DisplayPort: Sampling frequency – 32/44.1/48 kHz, Sampling bits – 16/20/24 bits	
PC control terminal		D-Sub 9-pin × 1		
USB port		USB type A × 1		
Ethernet/LAN/HDBaseT port		RJ-45 × 1, Supports 10BASE-T/100BASE-TX		
Remote terminal		Stereo mini jack × 1		
3D SYNC output terminal		5 V / 10 mA, synchronized signal output for 3D use		
Usage environment			Operating temperature: 41 to 104°F (5 to 40°C) ^{(*)5} Operating humidity: 20 to 80% (with no condensation) Storage temperature: 14 to 122°F (-10 to 50°C) Storage humidity: 20 to 80% (with no condensation) Operating altitude: 0 to 3650 m/12000 feet (1700 to 3650 m/5500 to 12000 feet: Set [FAN MODE] to [HIGH ALUTITUDE])	
Power supply			100-240 V AC, 50/60 Hz	
Power consumption	LIGHT MODE	NORMAL	PA803UL: 798 W (100-130 V AC) / 774 W (200-240 V AC) PA653UL: 627 W (100-130 V AC) / 613 W (200-240 V AC)	
		ECO1	PA803UL: 604 W (100-130 V AC) / 592 W (200-240 V AC) PA653UL: 580 W (100-130 V AC) / 566 W (200-240 V AC)	
		ECO2	PA803UL: 470 W (100-130 V AC) / 464 W (200-240 V AC) PA653UL: 437 W (100-130 V AC) / 431 W (200-240 V AC)	
		LONG LIFE	PA803UL: 285 W (100-130 V AC) / 285 W (200-240 V AC) PA653UL: 276 W (100-130 V AC) / 276 W (200-240 V AC)	
	STANDBY	Link-up	0.15 W (100-130 V AC) / 0.21 W (200-240 V AC)	
		Link-down	0.11 W (100-130 V AC) / 0.16 W (200-240 V AC)	
Rated input current			PA803UL: 11.8 A (100-130 V AC), 5.2 A (200-240 V AC) PA653UL: 10.2 A (100-130 V AC), 4.5 A (200-240 V AC)	
Power cord specification			15A or higher ^{(*)6}	
External dimensions (W × H × D)			22.8" (width) × 8.2" (height) × 19.5" (depth)/580 (width) × 208 (height) × 494 (depth) mm (including protruding parts) 22.8" (width) × 8.1" (height) × 19.3" (depth)/580 (width) × 205 (height) × 490 (depth) mm (not including protruding parts)	
Weight			40.2 lbs/18.2 kg (not including lens)	

*1 Effective pixels are more than 99.99%.

*2 Compliance with ISO21118-2012

*3 This is the light output value (lumens) mounting the lens unit, NP41ZL, when the [PRESET] mode is set to [HIGH-BRIGHT]. The light output values will be dropped according to the setting of [LIGHT MODE]. If any other mode is selected as the [PRESET] mode, the light output value may drop slightly.

*4 If you are unable to view material via the HDMI input, this does not necessarily mean the projector is not functioning properly. With the implementation of HDCP, there may be cases in which certain content is protected with HDCP and might not be displayed due to the decision/intention of the HDCP community (Digital Content Protection, LLC).

Video: HDR, Deep Color, 8/10/12-bit, Lip Sync.

Audio: LPCM; up to 2 ch, sample rate 32/44.1/48 KHz, sample bit; 16/20/24-bit

HDMI: Supports HDCP2.2/1.4

DisplayPort: Supports HDCP 1.4

HDBaseT: Supports HDCP 2.2/1.4

*5 Depending on the altitude and temperature, the projector goes into "Forced ECO Mode" in the state [NORMAL] or [ECO1] has been selected for [LIGHT MODE].

*6 In UK, use a BS-approved power cord with molded plug having a black (16A) fuse installed for use with this projector.

• These specifications and the product's design are subject to change without notice.

Option lens (sold separately)

NP40ZL	Throw ratio 0.79 - 1.11:1, F2.0 - 2.5, f = 13.3 - 18.6 mm
NP41ZL	Throw ratio 1.30 - 3.02:1, F1.7 - 2.0, f = 21.8 - 49.7 mm
NP42ZL	Throw ratio 2.88 - 5.72:1, F2.2 - 2.6, f = 49.7 - 99.8 mm

NOTE:

- *The above throw ratio is for projecting on 100" screen.*

4 Cabinet Dimensions

Unit: mm (inch)

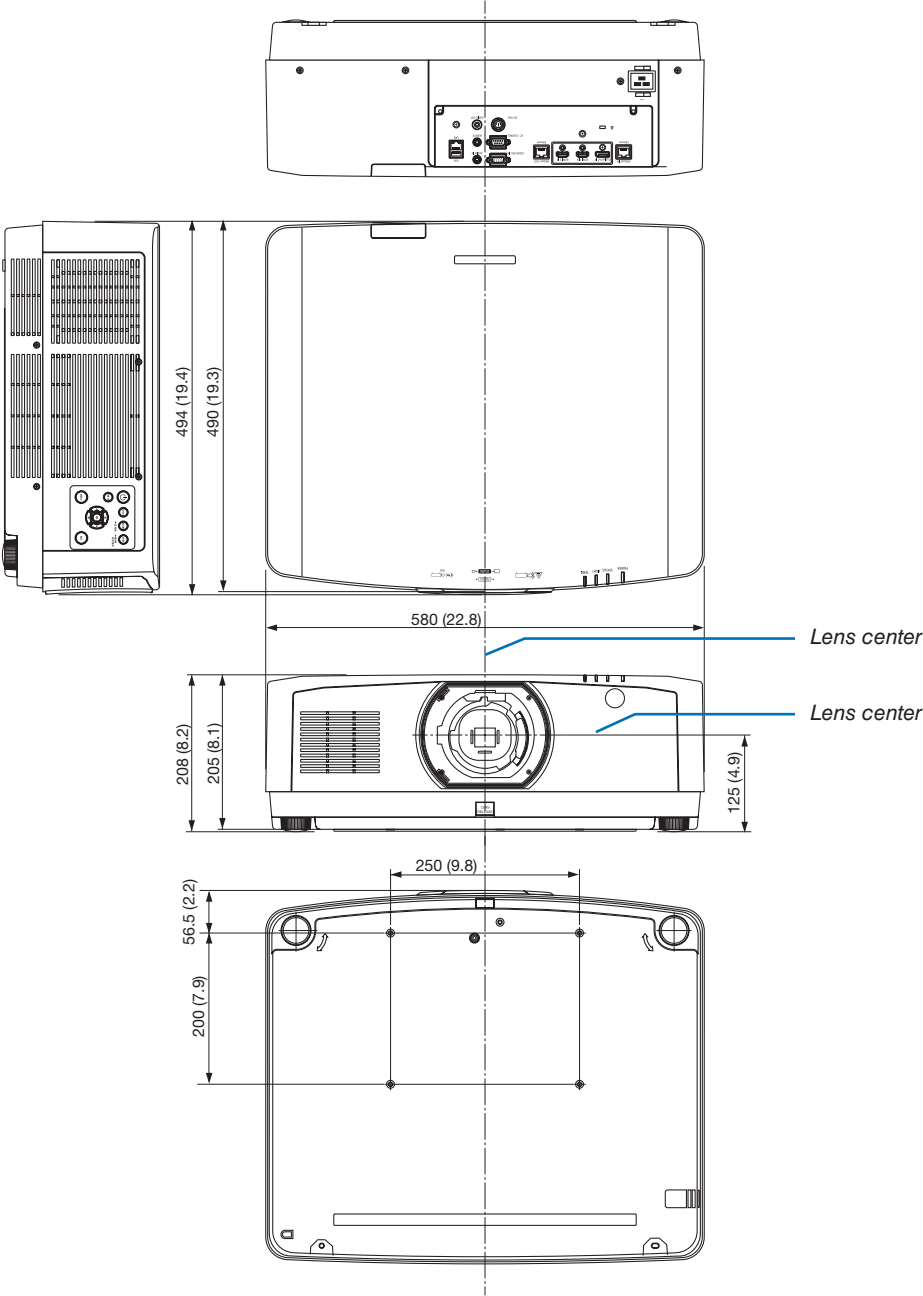

5 Pin assignments and signal names of main connectors

COMPUTER IN/ Component Input Connector (Mini D-Sub 15 Pin)

Connection and signal level of each pin

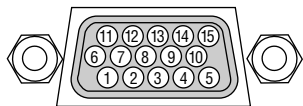

Signal Level

Video signal : 0.7Vp-p (Analog)

Sync signal : TTL level

Pin No.	RGB Signal (Analog)	YCbCr Signal
1	Red	Cr
2	Green or Sync on Green	Y
3	Blue	Cb
4	Ground	
5	Ground	
6	Red Ground	Cr Ground
7	Green Ground	Y Ground
8	Blue Ground	Cb Ground
9	No Connection	
10	Sync Signal Ground	
11	No Connection	
12	Bi-directional DATA (SDA)	
13	Horizontal Sync or Composite Sync	
14	Vertical Sync	
15	Data Clock	

HDMI 1 IN/HDMI 2 IN Connector (Type A)

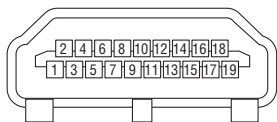

Pin No.	Signal	Pin No.	Signal
1	TMDS Data 2+	11	TMDS Clock Shield
2	TMDS Data 2 Shield	12	TMDS Clock-
3	TMDS Data 2-	13	CEC
4	TMDS Data 1+	14	Disconnection
5	TMDS Data 1 Shield	15	SCL
6	TMDS Data 1-	16	SDA
7	TMDS Data 0+	17	DDC/CEC grounding
8	TMDS Data 0 Shield	18	+5 V power supply
9	TMDS Data 0-	19	Hot plug detection
10	TMDS Clock +		

DisplayPort IN Connector

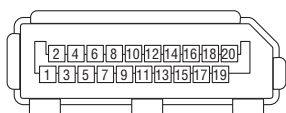

Pin No.	Signal	Pin No.	Signal
1	Main link lane 3-	11	Grounding 0
2	Grounding 3	12	Main link lane 0+
3	Main link lane 3+	13	Configuration 1
4	Main link lane 2-	14	Configuration 2
5	Grounding 2	15	Supplementary channel +
6	Main link lane 2+	16	Grounding 4
7	Main link lane 1-	17	Supplementary channel -
8	Grounding 1	18	Hot plug detection
9	Main link lane 1+	19	Return
10	Main link lane 0-	20	+3.3 V power supply

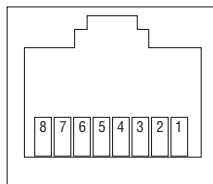
HDBaseT IN/Ethernet Port (RJ-45)

Pin No.	Signal
1	TxD+/HDBT0+
2	TxD-/HDBT0-
3	RxD+/HDBT1+
4	Disconnection/HDBT2+
5	Disconnection/HDBT2-
6	RxD-/HDBT1-
7	Disconnection/HDBT3+
8	Disconnection/HDBT3-

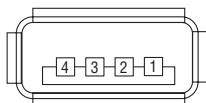
USB-A Port (Type A)

Pin No.	Signal
1	V _{BUS}
2	D-
3	D+
4	Grounding

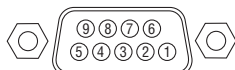
PC CONTROL Port (D-Sub 9 Pin)

Pin No.	Signal
1	Unused
2	RxD reception data
3	TxD transmission data
4	Unused
5	Grounding
6	Unused
7	RTS transmission request
8	CTS transmission allowed
9	Unused

6 Changing the Background Logo (Virtual Remote Tool)

This will help you perform operations such as projector's power on or off and signal selection via a LAN connection. It is also used to send an image to the projector and register it as the logo data of the projector. After registering it, you can lock the logo to prevent it from changing.

Control Functions

Power On/Off, signal selection, picture freeze, picture mute, audio mute, Logo transfer to the projector, and remote control operation on your PC.

Virtual Remote screen



Remote Control Window

Use this button for changing the background logo.



Toolbar

For getting the Virtual Remote Tool, please visit our web site and download it:

<http://www.nec-display.com/dl/en/index.html>

NOTE:

- Remote Control Window is not available for changing the background logo.
Please see the HELP menu of the Virtual Remote Tool about how to display the Toolbar.
- Logo data (graphics) that can be sent to the projector with Virtual Remote Tool has the following restrictions:
(Only via serial or LAN connection)
 - * File size: Within 256 kilobytes
 - * Image size: Within the resolution of the projector
 - * File format: PNG (Full color)
- Logo data (image) sent using the Virtual Remote Tool will be displayed in the center with the surrounding area in black.
- To put the default "NEC logo" back in the background logo, you need to register it as the background logo by using the image file (Logo\necpj_bbwux.png) included on the supplied NEC Projector CD-ROM.

7 Troubleshooting





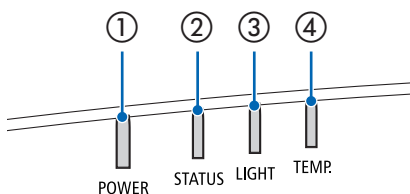































This section helps you resolve problems you may encounter while setting up or using the projector.



















Feature of each indicator



- ① POWER indicator
This indicator informs the power status of the projector.
- ② STATUS indicator
This indicator lights/blinks when a button is pressed while the CONTROL PANEL LOCK function is utilized, or while performing the lens calibration and specific operations.
- ③ LIGHT indicator
This indicator informs the state of light source, used time of the light source, and the status of LIGHT MODE.
- ④ TEMP. indicator
This is the temperature indicator informing temperature trouble when the ambient temperature is too high/low.

Indicator Message (Status message)

POWER	STATUS	LIGHT	TEMP.	Projector status
 Off	 Off	 Off	 Off	Power is off
 Orange (Blink*1)	 Off	 Off	 Off	In the state of Standby (Standby mode is NORMAL and the network is ready).
 Orange (Blink*2)	 Off	 Off	 Off	In the state of Standby (Standby mode is NORMAL and the network is unavailable).
 Orange (Light)	 Off	 Off	 Off	In the state of Standby (Standby mode is NORMAL and the network is available)
 Orange (Blink*3)	 Off	 Off	 Off	ON time as the program timer is activated. (In the state of Standby)
 Green (Light)	 Off	 Off	 Off	In the state of Sleep
 Green (Blink*3)	 Off	 Off	 Off	ON time as the program timer is activated. (In the state of Sleep)
 Blue (Light)	 Off	 Green (Light)	 Off	Powered state (LIGHT MODE is NORMAL or ECO1)
 Blue (Light)	 Off	 Green (Blink*3)	 Off	Powered state (LIGHT MODE is ECO2 or LONG LIFE)

POWER	STATUS	LIGHT	TEMP.	Projector status
Status varies	 Orange (Blink*4)	Status varies	 Off	Lens calibration implement request.
 Blue (Light)	 Green (Blink*4)	 Status varies	 Off	Performing the lens calibration
 Blue (Light)	 Status varies	 Off	 Off	Shutter function is activating
 Blue (Blink*3)	 Off	 Status varies	 Off	OFF Timer is activated, OFF time as the program timer is activated (Powered state)
 Blue (Blink*5)	 Off	 Off	 Off	Preparing for powering ON

*1 Repetition to light on for 1.5 seconds / off for 1.5 seconds





















*2 Repetition to light on for 1.5 seconds / off for 7.5 seconds

*3 Repetition to light on for 2.5 seconds / off for 0.5 seconds

*4 Repetition to light on for 0.5 seconds / off for 0.5 seconds / on for 0.5 seconds / off for 2.5 seconds

*5 Repetition to light on for 0.5 seconds / off for 0.5 seconds

Indicator Message (Error message)

POWER	STATUS	LIGHT	TEMP.	Projector status	Procedure
 Blue (Light)	 Orange (Light)	Status varies	 Off	A button has been pressed while the KEY LOCK is activated.	The projector's keys are locked. The setting must be canceled to operate the projector. (→ page 120)
				ID numbers for the projector and the remote control do not match.	Check the control IDs (→ page 121)
 Blue (Light)	 Off	 Orange (Light)	 Orange (Light)	Temperature problem (In the Forced ECO)	Ambient temteprature is high. Lower the room temperature.
 Red (Blink* ⁵)	 Off	 Off	 Off	Temperature problem	Ambient temperature is out of the operation temperature. Check if any obstruction stays near the exhaust vent.
Status varies	 Off	 Red (Blink* ⁵)	 Off	Hardware problem	Problem with the hardware. Contact your dealer.
 Red (Blink* ⁵)	 Red (Light)	 Red (Light)	 Off	Lens mounting error/Lens problem	Lens is not mounted properly. Mout it (→ see page 138, 160). If the indica- tor message is remain unchanged even if the lens is mounted properly, contact your dealer.
 Red (Light)	Status varies	Status varies	 Off	Error requiring service support	Contact your dealer or service person- nel. Make sure to check and inform indicator status for asking to repair.

*1 Repetition to light on for 1.5 seconds / off for 1.5 seconds

*2 Repetition to light on for 1.5 seconds / off for 7.5 seconds

*3 Repetition to light on for 2.5 seconds / off for 0.5 seconds

*4 Repetition to light on for 0.5 seconds / off for 0.5 seconds / on for 0.5 seconds / off for 2.5 seconds

*5 Repetition to light on for 0.5 seconds / off for 0.5 seconds

- When the thermal protector is activated:

When inside temperature of the projector becomes too high or low, the POWER indicator start to red blink in a short cycle. After this happened, the thermal protector will activate and the projector may be turned off.

In this case, please take the below measures:

- Pull out the power plug from the wall inlet.
- Place the projector in cool place if it has been placed in high ambient temperature.
- Clean the exhaust vent if dust has accumulated on.
- Leave the projector for about one hour until inside temperature gets lower.

Explanation on the POWER indicator and standby state
In the state the selected PROFILE for WIRED LAN is available.

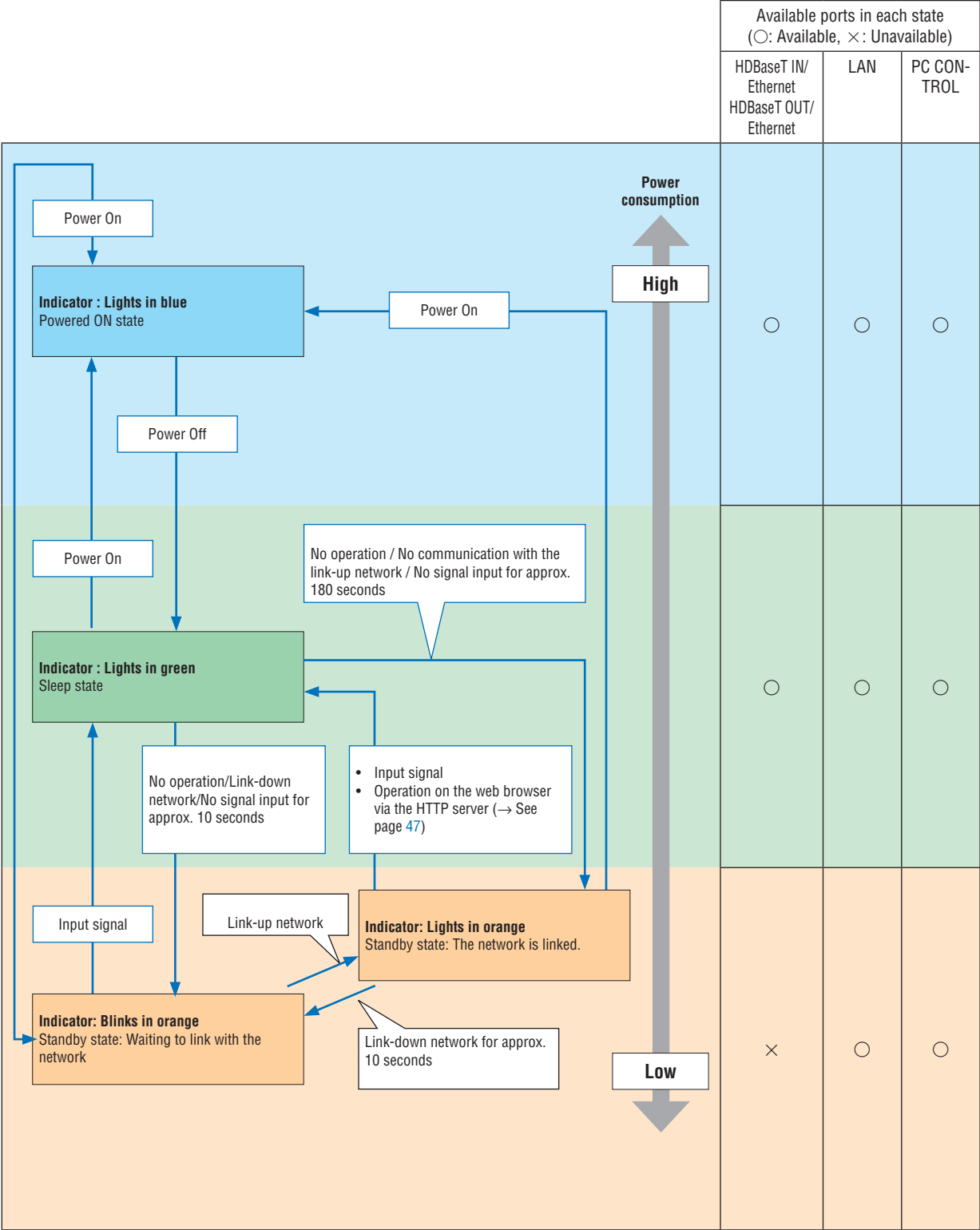

In the state the selected PROFILE for WIRED LAN is unavailable.

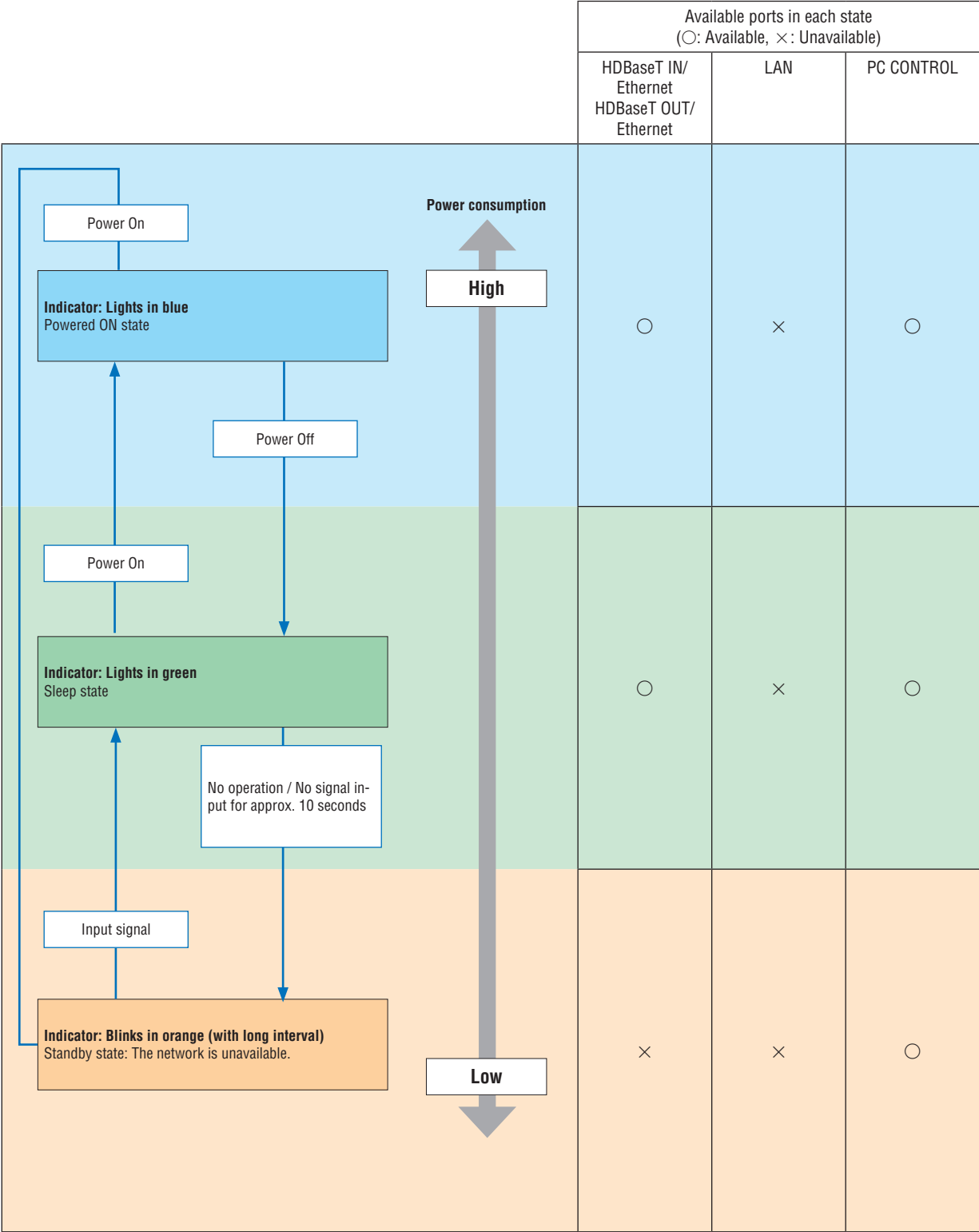

Common Problems & Solutions

(→ “Indicator Message” on page 165.)

Problem	Check These Items
Does not turn on or shut down	<ul style="list-style-type: none"> • Check that the power cord is plugged in and that the power button on the projector cabinet or the remote control is on. (→ pages 14, 16) • Check to see if the projector has temperature error. If projector inside temperature is too hot or cool, it disabled to turn on the projector as the protection. Wait for a moment and try turn on the projector again. • Set [FAN MODE] to [HIGH ALTITUDE] when using the projector at altitudes approximately 5500 feet/1700 meters or higher. Using the projector at altitudes approximately 5500 feet/1700 meters or higher without setting to [HIGH ALTITUDE] can cause the projector to overheat and the projector could shut down. If this happens, wait a couple minutes and turn on the projector. (→ page 112) If you turn on the projector immediately after the light module is turned off, the fans run without displaying an image for some time and then the projector will display the image. Wait for a moment. • In case it's hard to think the trouble is not caused on the above mentioned conditions, unplug the power cord from the outlet. Then wait 5 minutes before plugging it in again. (→ page 28, 29)
Will turn off	<ul style="list-style-type: none"> • Ensure that the [OFF TIMER], [AUTO POWER OFF] or [PROGRAM TIMER] is off. (→ page 117, 131)
No picture	<ul style="list-style-type: none"> • Check if the appropriate input is selected. (→ page 18) If there is still no picture, press the INPUT button or one of the input buttons again. • Ensure your cables are connected properly. • Use menus to adjust the brightness and contrast. (→ page 88) • Is the [POWER ON SHUTTER] in the on-screen menu set to [CLOSE]? • Check that the SHUTTER (lens shutter) or AV-MUTE (image off) buttons are not pressed. • Reset the settings or adjustments to factory preset levels using the [RESET] in the Menu. (→ page 132) • Enter your registered keyword if the Security function is enabled. (→ page 41) • If the HDMI input or the DisplayPort signal cannot be displayed, try the following. <ul style="list-style-type: none"> - Reinstall your driver for the graphics card built in your computer, or use the updated driver. For reinstalling or updating your driver, refer to the user guide accompanied with your computer or graphics card, or contact the support center for your computer manufacturer. Install the updated driver or OS on your own responsibility. We are not liable for any trouble and failure caused by this installation. • The signal may not be supported depending on the HDBaseT transmission device. In addition, RS232C interface may not be supported. • Be sure to connect the projector and notebook PC while the projector is in standby mode and before turning on the power to the notebook PC. In most cases the output signal from the notebook PC is not turned on unless connected to the projector before being powered up. <ul style="list-style-type: none"> * If the screen goes blank while using your remote control, it may be the result of the computer's screen-saver or power management software. • See also the page 172.
Picture suddenly becomes dark	<ul style="list-style-type: none"> • Check if the projector is in the Forced ECO mode because of too high ambient temperature. If this is the case, lower the internal temperature of the projector by selecting [HIGH] for [FAN MODE]. (→ page 112)
Color tone or hue is unusual	<ul style="list-style-type: none"> • Check if an appropriate color is selected in [WALL COLOR]. If so, select an appropriate option. (→ page 112) • Adjust [HUE] in [PICTURE]. (→ page 89)
Image isn't square to the screen	<ul style="list-style-type: none"> • Reposition the projector to improve its angle to the screen. (→ page 20) • Perform [GEOMETRIC CORRECTION] when the trapezoid is distorted. (→ page 101)
Picture is blurred	<ul style="list-style-type: none"> • Adjust the focus. (→ page 22) • Reposition the projector to improve its angle to the screen. (→ page 20) • Ensure that the distance between the projector and screen is within the adjustment range of the lens. (→ page 152) • Has the lens been shifted by an amount exceeding the guaranteed range? (→ page 153) • Condensation may form on the lens if the projector is cold, brought into a warm place and is then turned on. Should this happen, let the projector stand until there is no condensation on the lens.
Flicker appears on screen	<ul style="list-style-type: none"> • Set [FAN MODE] to other than [HIGH ALTITUDE] mode when using the projector at altitudes approximately 5500 feet/1700 meters or lower. Using the projector at altitudes less than approximately 5500 feet/1700 meters and setting to [HIGH ALTITUDE] can cause the light module to overcool, causing the image to flicker. Switch [FAN MODE] to [AUTO]. (→ page 112)
Image is scrolling vertically, horizontally or both	<ul style="list-style-type: none"> • Check the computer's resolution and frequency. Make sure that the resolution you are trying to display is supported by the projector. (→ page 155) • Adjust the computer image manually with the Horizontal/Vertical in the [IMAGE OPTIONS]. (→ page 91)
Remote control does not work	<ul style="list-style-type: none"> • Install new batteries. (→ page 11) • Make sure there are no obstacles between you and the projector. • Stand within 40 m/1575 inch of the projector. (→ page 12)

Problem	Check These Items
Indicator is lit or blinking	<ul style="list-style-type: none">• See the Indicator Message. (→ page 165)
Cross color in RGB mode	<ul style="list-style-type: none">• Press the AUTO ADJ. button on the projector cabinet or the remote control. (→ page 27)• Adjust the computer image manually with [CLOCK]/[PHASE] in [IMAGE OPTIONS] in the menu. (→ page 90)

For more information contact your dealer.

If there is no picture, or the picture is not displayed correctly.

- Power on process for the projector and the PC.

Be sure to connect the projector and notebook PC while the projector is in standby mode and before turning on the power to the notebook PC.

In most cases the output signal from the notebook PC is not turned on unless connected to the projector before being powered up.

NOTE: You can check the horizontal frequency of the current signal in the projector's menu under Information. If it reads "0kHz", this means there is no signal being output from the computer. (→ page 134 or go to next step)

- Enabling the computer's external display.

Displaying an image on the notebook PC's screen does not necessarily mean it outputs a signal to the projector. When using a PC compatible laptop, a combination of function keys will enable/disable the external display. Usually, the combination of the "Fn" key along with one of the 12 function keys gets the external display to come on or off. For example, NEC laptops use Fn + F3, while Dell laptops use Fn + F8 key combinations to toggle through external display selections.

- Non-standard signal output from the computer

If the output signal from a notebook PC is not an industry standard, the projected image may not be displayed correctly. Should this happen, deactivate the notebook PC's LCD screen when the projector display is in use. Each notebook PC has a different way of deactivate/reactivate the local LCD screens as described in the previous step. Refer to your computer's documentation for detailed information.

- Image displayed is incorrect when using a Mac

When using a Mac with the projector, set the DIPswitch of the Mac adapter (not supplied with the projector) according to your resolution. After setting, restart your Mac for the changes to take affect.

For setting display modes other than those supported by your Mac and the projector, changing the DIP switch on a Mac adapter may bounce an image slightly or may display nothing. Should this happen, set the DIP switch to the 13" fixed mode and then restart your Mac. After that, restore the DIP switches to a displayable mode and then restart the Mac again.

NOTE: A Video Adapter cable manufactured by Apple Computer is needed for a MacBook which does not have a mini D-Sub 15-pin connector.

- Mirroring on a MacBook

* When using the projector with a MacBook, output may not be set to 1920 × 1200 unless "mirroring" is off on your MacBook. Refer to owner's manual supplied with your Mac computer for mirroring.

- Folders or icons are hidden on the Mac screen

Folders or icons may not be seen on the screen. Should this happen, select [View] → [Arrange] from the Apple menu and arrange icons.

8 PC Control Codes and Cable Connection

PC Control Codes

Function	Code Data								
POWER ON	02H	00H	00H	00H	00H	02H			
POWER OFF	02H	01H	00H	00H	00H	03H			
INPUT SELECT HDMI1	02H	03H	00H	00H	02H	01H	A1H	A9H	
INPUT SELECT HDMI2	02H	03H	00H	00H	02H	01H	A2H	AAH	
INPUT SELECT DisplayPort	02H	03H	00H	00H	02H	01H	A6H	AEH	
INPUT SELECT COMPUTER	02H	03H	00H	00H	02H	01H	01H	09H	
INPUT SELECT HDBaseT	02H	03H	00H	00H	02H	01H	BFH	C7H	
PICTURE MUTE ON	02H	10H	00H	00H	00H	12H			
PICTURE MUTE OFF	02H	11H	00H	00H	00H	13H			
SOUND MUTE ON	02H	12H	00H	00H	00H	14H			
SOUND MUTE OFF	02H	13H	00H	00H	00H	15H			

NOTE: Contact your local dealer for a full list of the PC Control Codes if needed.

Cable Connection

Communication Protocol

Baud rate115200/38400/19200/9600/4800 bps
 Data length8 bits
 ParityNo parity
 Stop bit1 bit
 X on/offNone
 Communications procedureFull duplex

NOTE: Depending on the equipment, a lower baud rate may be recommended for long cable runs.

PC Control Port (D-SUB 9P)

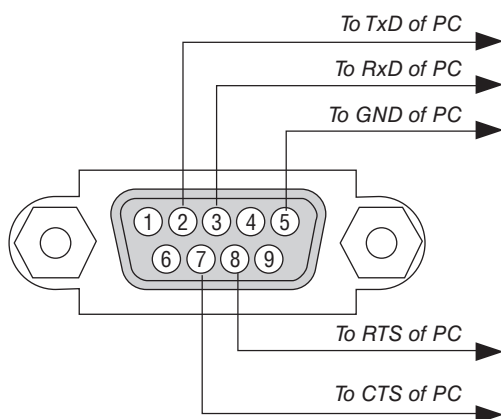

NOTE 1: Pins 1, 4, 6 and 9 are no used.

NOTE 2: Jumper "Request to Send" and "Clear to Send" together on both ends of the cable to simplify cable connection.

NOTE 3: For long cable runs it is recommended to set communication speed within projector menus to 9600 bps.

ABOUT THE ASCII CONTROL COMMAND

This device supports the common ASCII Control Command for controlling our projector and monitor.

Please visit our web site for detailed information about the command.

http://www.nec-display.com/dl/en/pj_manual/lineup.html

HOW TO CONNECT WITH AN EXTERNAL DEVICE

There are two methods to connect the projector with an external device such as a computer.

1. Connection thru the serial port.
Connects the projector to a computer by a serial cable (a cross cable).
2. Connection via network (LAN/HDBaseT)
Connects the projector to a computer by a LAN cable.
Concerning to the type of LAN cable, please ask to your network administrator.

CONNECTION INTERFACE

1. Connection thru the serial port.

Communication Protocol

Item	Information
Baud rate	115200/38400/19200/9600/4800 bps
Data length	8 bits
Parity bit	No parity
Stop bit	1 bit
Flow control	None
Communications procedure	Full duplex

2. Connection via network

Communication Protocol (Connection via LAN)

Item	Information
Communication speed	Set automatically (10/100 Mbps)
Supported standard	IEEE802.3 (10BASE-T) IEEE802.3u (100BASE-TX, Auto-Negotiation)

Use the TCP port number 7142 for transmitting and receiving command.

Communication Protocol (Connection via HDBaseT)

Item	Information
Communication speed	100 Mbps
Supported standard	IEEE802.3u (100BASE-TX, Auto-Negotiation)

Use the TCP port number 7142 for transmitting and receiving command.

PARAMETERS FOR THIS DEVICE

Input command

Input terminal	Response	Parameter
HDMI1	hdmi1	hdmi1 or hdmi
HDMI2	hdmi2	hdmi2
DisplayPort	displayport	displayport or displayport1
COMPUTER	computer	One among computer, computer1, vga, vga1, rgb, and rgb1
HDBaseT	hdbaset	hdbaset or hdbaset1

Status command

Response	Error Status
error:temp	Temperature error
error:fan	Fan trouble
error:light	Light source trouble
error:lens	Lens trouble
error:system	System trouble

9 Troubleshooting Check List

Before contacting your dealer or service personnel, check the following list to be sure repairs are needed also by referring to the “Troubleshooting” section in your user’s manual. This checklist below will help us solve your problem more efficiently.

* Print this page and the next page for your check.

Frequency of occurrence always sometimes (How often? _____) other (_____)

Power

- No power (POWER indicator does not light blue). See also “Status Indicator (STATUS)”.
- Power cord’s plug is fully inserted into the wall outlet.
- No power even though you press and hold the POWER button.
- Shut down during operation.
 - Power cord’s plug is fully inserted into the wall outlet.
 - [AUTO POWER OFF] is turned off (only models with the [AUTO POWER OFF] function).
 - [OFF TIMER] is turned off (only models with the [OFF TIMER] function).

Video and Audio

- No image is displayed from your PC or video equipment to the projector.
 - Still no image even though you connect the projector to the PC first, then start the PC.
 - Enabling your notebook PC’s signal output to the projector.
 - *A combination of function keys will enable/disable the external display. Usually, the combination of the “Fn” key along with one of the 12 function keys turns the external display on or off.*
 - No image (blue or black background, no display).
 - Still no image even though you press the AUTO ADJ. button.
 - Still no image even though you carry out [RESET] in the projector’s menu.
 - Signal cable’s plug is fully inserted into the input connector
 - A message appears on the screen.
(_____)
 - The source connected to the projector is active and available.
 - Still no image even though you adjust the brightness and/or the contrast.
 - Input source’s resolution and frequency are supported by the projector.
- Image is too dark.
 - Remains unchanged even though you adjust the brightness and/or the contrast.
- Image is distorted.
 - Image appears to be trapezoidal (unchanged even though you carry out the [KEYSTONE] adjustment).
- Parts of the image are lost.
 - Still unchanged even though you press the AUTO ADJ. button.
 - Still unchanged even though you carry out [RESET] in the projector’s menu.
- Image is shifted in the vertical or horizontal direction.
 - Horizontal and vertical positions are correctly adjusted on a computer signal.
 - Input source’s resolution and frequency are supported by the projector.
 - Some pixels are lost.
- Image is flickering.
 - Still unchanged even though you press the AUTO ADJ. button.
 - Still unchanged even though you carry out [RESET] in the projector’s menu.
 - Image shows flickering or color drift on a computer signal.
 - Still unchanged even though you change [FAN MODE] from [HIGH ALTITUDE] to [AUTO].
- Image appears blurry or out of focus.
 - Still unchanged even though you checked the signal’s resolution on PC and changed it to projector’s native resolution.
 - Still unchanged even though you adjusted the focus.
- No sound.
 - Audio cable is correctly connected to the audio input of the projector.
 - Still unchanged even though you adjusted the volume level.
 - AUDIO OUT is connected to your audio equipment (only models with the AUDIO OUT connector).

Other

- Remote control does not work.
 - No obstacles between the sensor of the projector and the remote control.
 - Projector is placed near a fluorescent light that can disturb the infrared remote controls.
 - Batteries are new and are not reversed in installation.
- Buttons on the projector cabinet do not work (only models with the [CONTROL PANEL LOCK] function)
 - [CONTROL PANEL LOCK] is not turned on or is disabled in the menu.
 - Still unchanged even though you press and hold the INPUT button for a minimum of 10 seconds.

In the space below please describe your problem in detail.

Information on application and environment where your projector is used

Projector

Model number:

Serial No.:

Date of purchase:

Light operating time (hours):

LIGHT MODE: NORMAL ECO1
 ECO2 LONG LIFE

Information on input signal:

Horizontal synch frequency [] kHz

Vertical synch frequency [] Hz

Synch polarity H (+) (-)

V (+) (-)

Synch type Separate Composite

Sync on Green

Indicator Message:

POWER

Blinks in Blue Green Orange Red

[] cycles

Lights in Blue Green Orange Red

STATUS

Blinks in Blue Green Orange Red

[] cycles

Lights in Blue Green Orange Red

LIGHT

Blinks in Blue Green Orange Red

[] cycles

Lights in Blue Green Orange Red

TEMP.

Blinks in Blue Green Orange Red

[] cycles

Lights in Blue Green Orange Red

Remote control model number:

Signal cable

NEC standard or other manufacturer's cable?

Model number: Length: inch/m

Distribution amplifier

Model number:

Switcher

Model number:

Adapter

Model number:

Installation environment

Screen size: inch

Screen type: White matte Beads Polarization
 Wide angle High contrast

Throw distance: feet/inch/m

Orientation: Ceiling mount Desktop

Power outlet connection:

Connected directly to wall outlet

Connected to power cord extender or other (the number of connected equipment _____)

Connected to a power cord reel or other (the number of connected equipment _____)

Computer

Manufacturer:

Model number:

Notebook PC / Desktop

Native resolution:

Refresh rate:

Video adapter:

Other:

Video equipment

VCR, Blu-ray player, Video camera, Video game or other

Manufacturer:

Model number:

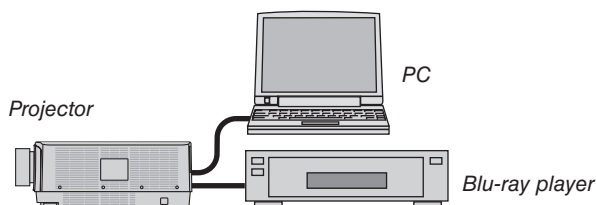

10 REGISTER YOUR PROJECTOR! (for residents in the United States, Canada, and Mexico)

Please take time to register your new projector. This will activate your limited parts and labor warranty and InstaCare service program.

Visit our web site at www.necdisplay.com, click on support center/register product and submit your completed form online.

Upon receipt, we will send a confirmation letter with all the details you will need to take advantage of fast, reliable warranty and service programs from the industry leader, NEC Display Solutions of America, Inc.

NEC