



PU9730 / PW9620 / PX9710

Digital Projector

BenQ User Manual



Table of Contents

Important safety instructions	4
Overview	7
Shipping contents	7
Projector exterior view	8
Front and upper side view.....	8
Rear and upper side view	8
IO panel	9
Control panel and functions	10
Remote control and functions	11
Notes on remote controller operation	12
Remote control operation.....	12
Setup and Operation	12
Install remote controller battery	13
Connecting to the projector.....	13
Projection lens selection and Installation.....	14
Installing or removing the optional lens	14
Installing the new lens	14
Removing the existing lens from the projector	15
Choosing a location	16
Projection distance and screen size	17
Lens shift adjustable range.....	20
Making connections	21
Preparations	21
Connect to PC.....	21
Connect to video equipment	22
Connect to control port.....	22
Connect to screen trigger.....	23
Connect to external digital transmitter	24
Using the projector	25
Preparations	25
Turning the projector on or off	26
Selecting an input source	27
Using the menus	28
Adjusting the projected Image.....	29
Adjusting the image position	29
Fine-tuning the image size and clarity.....	29
Adjusting the projection angle	30
Correcting picture distortion	31
Auto-adjusting the image.....	31
Turning off the projector.....	32

Using On-Screen Display	33
Using the Menus.....	33
Navigating the OSD.....	33
On-Screen Display (OSD) menus	34
OSD menu - DISPLAY	38
OSD menu - PICTURE	40
OSD menu - LAMP	42
OSD menu - ALIGNMENT	43
OSD menu - CONTROL	46
OSD menu - SERVICE	49
Additional information	51
Cleaning the lens	51
Care of the projector	51
Cleaning the projector case.....	51
Storing the projector.....	51
Transporting the projector	51
Replacing the lamp	52
Installing the optional color wheel	54
Replacing the filter	55
Specifications	56
Dimension	57
Timing chart	58
PC timing	58
3D supported timing	59
RS232 command control	61
Control the projector through a network	64
Set up the projector for networking.....	64
Control the projector through a web browser	65
Projector Status.....	65
Alert mail setup.....	66
Crestron control page	67
Troubleshooting	69
Indicator messages.....	69
Common problems and solutions.....	70
Tips for troubleshooting.....	70
Image problems.....	70
Lamp problems	71
Remote control problems.....	71
BenQ ecoFACTS	72
Copyright	73
Disclaimer	73
Statement regarding hyperlinks and third-party websites.....	73

Thank you for your purchase of this quality BenQ projector. For the best results, please read this manual through carefully as it is your guide through the control menus and operation.

Important safety instructions

1. Please read this user manual before you operate your projector. Keep this manual in a safe place for future reference.

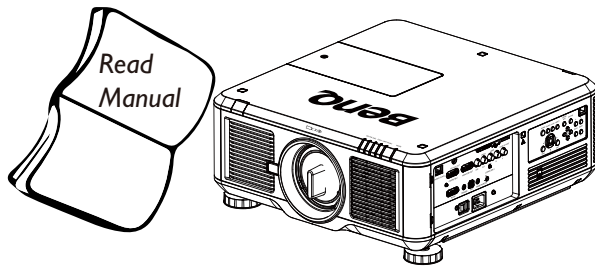

2. Always place the projector on a level, horizontal surface during operation.
 - Do not place the projector on an unstable cart, stand, or table as it may fall and be damaged.
 - Do not place inflammables near the projector.
 - Do not use if tilted at an angle of more than 10 degrees left to right, nor at angle of more than 15 degrees front to back.

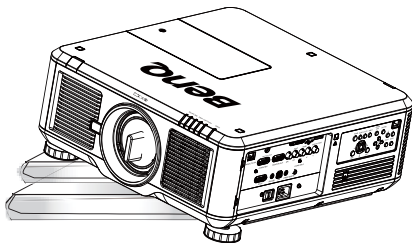

3. Do not store the projector on end vertically. Doing so may cause the projector to fall over, causing injury or resulting in damage.

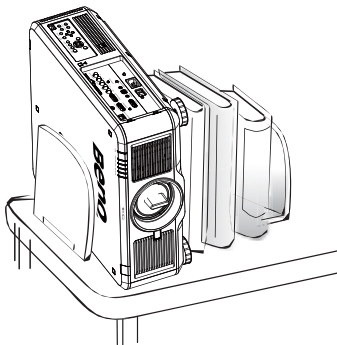

4. Do not place the projector in any of the following environments:

- space that is poorly ventilated or confined. Allow at least 50 cm clearance from walls and free flow of air around the projector.
- locations where temperatures may become excessively high, such as the inside of a car with all windows closed.
- locations where excessive humidity, dust, or cigarette smoke may contaminate optical components, shorten the projector's lifespan and darken the screen.

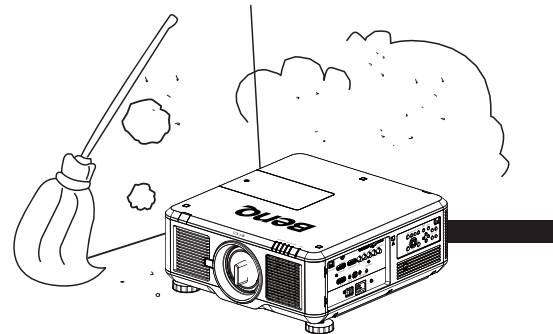

- locations near fire alarms.
- locations with an ambient temperature above 35°C/95°F.
- locations where altitude is higher than 1500 meters/4920 feet above sea level.

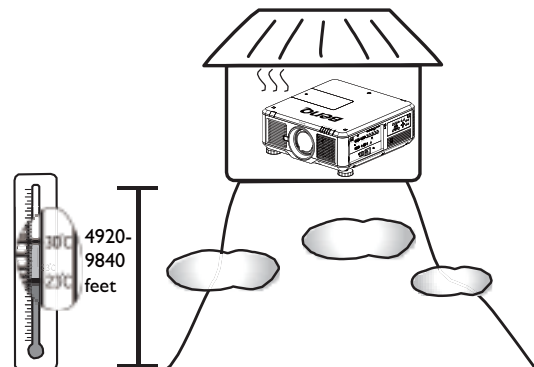

5. Do not block the vents holes while the projector is on (even in standby mode):
- Do not cover the projector with any item.
 - Do not place the projector on a blanket, bedding or any other soft surface.

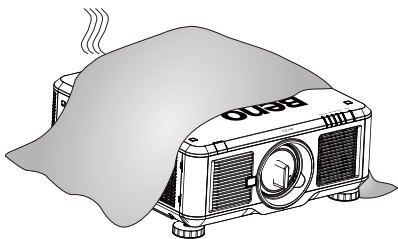

6. In areas where the mains power supply voltage may fluctuate by ± 10 volts, it is recommended that you connect your projector through a power stabilizer, surge protector or uninterruptible power supply (UPS) as appropriate to your situation.

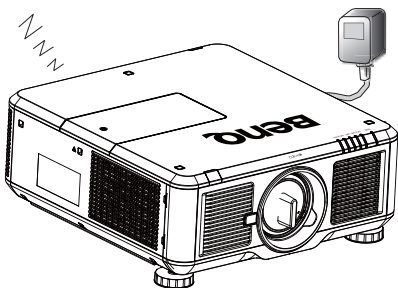

7. Do not step on the projector or place any objects upon it.

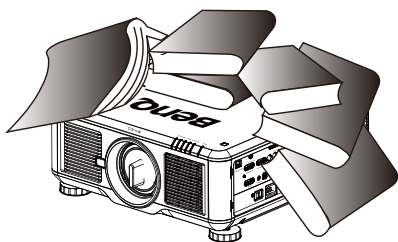

8. Do not place liquids near or on the projector. Liquids spilled into the projector will void your warranty. If the projector does become wet, disconnect it from the power point and call BenQ to have the projector repaired.

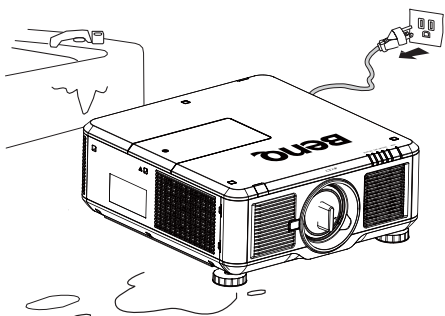

9. Do not look straight into the projector lens during operation. It may harm your sight.

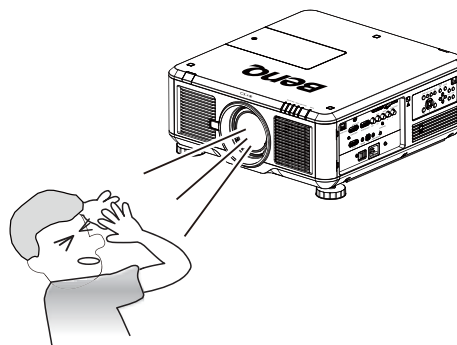

10. Do not operate the projector lamp beyond the rated lamp life. Excessive operation of lamps beyond the rated life could cause a lamp to break on rare occasions.

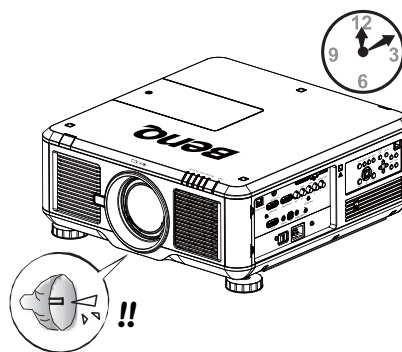

11. The lamp becomes extremely hot during operation. Allow the projector to cool for approximately 45 minutes prior to removing the lamp assembly for replacement.

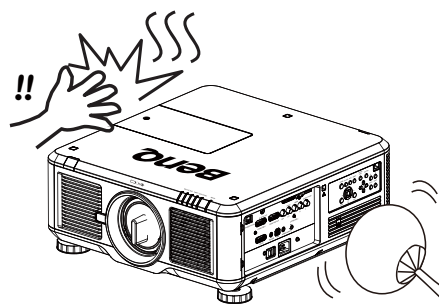

12. This projector is capable of displaying inverted images for ceiling mount installation. Use only BenQ's Ceiling Mount Kit for mounting.

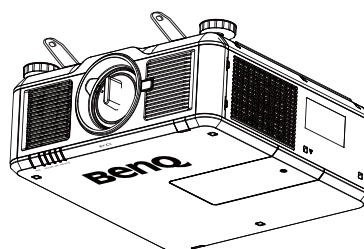

13. Never attempt to replace the lamp assembly until the projector has cooled down and is unplugged from the power supply.

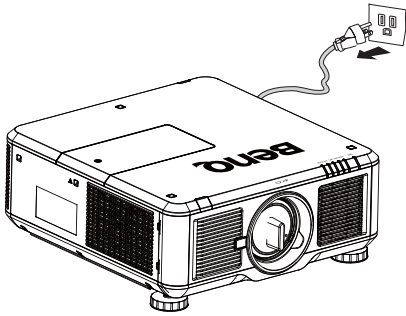

14. When you think service or repair is required, take the projector only to a suitably qualified technician.

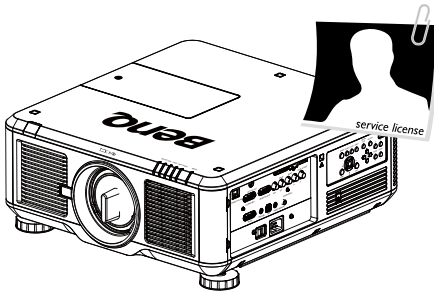

15. Do not attempt to disassemble this projector. There are dangerous high voltages inside which may cause death if you should come into contact with live parts. The only user serviceable part is the lamp which has its own removable cover. Under no circumstances should you ever undo or remove any other covers. Refer servicing only to suitably qualified professional service personnel.

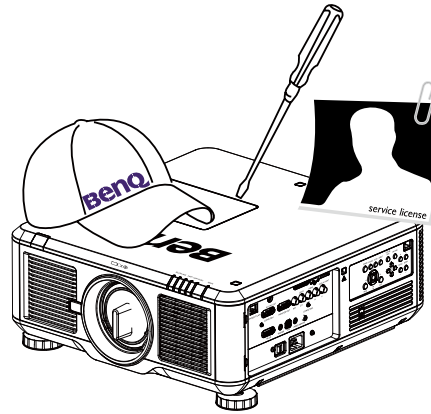

Please keep the original packing for possible future shipment.

Overview

Shipping contents

Carefully unpack and verify that you have the items below. Some of the items may not be available depending on your region of purchase. Please check with your place of purchase.



Some of the accessories may vary from region to region.

The warranty card is only supplied in some specific regions. Please consult your dealer for detailed information.

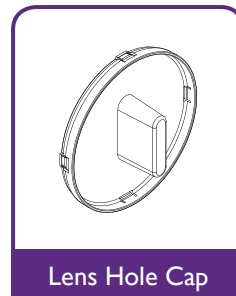
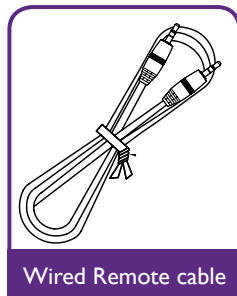
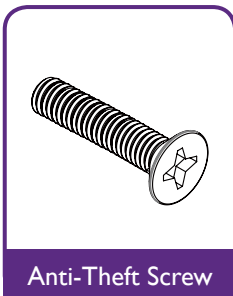
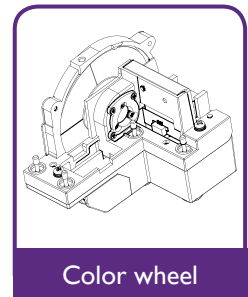
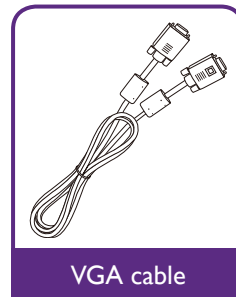
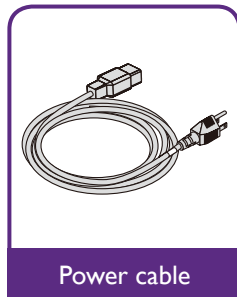
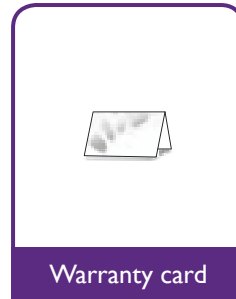

Projector exterior view

Front and upper side view

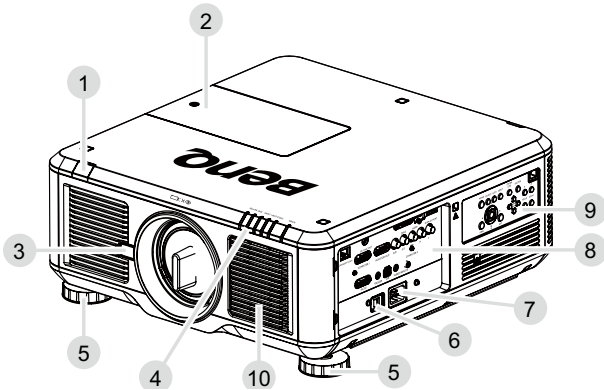

- 1. Front IR sensor
- 2. Color wheel door
- 3. Lens release button
- 4. LED Indication
- 5. Foot for adjusting projector level
- 6. AC power switch
- 7. AC inlet
- 8. IO panel
- 9. Control panel
- 10. Air intake and filter

Rear and upper side view

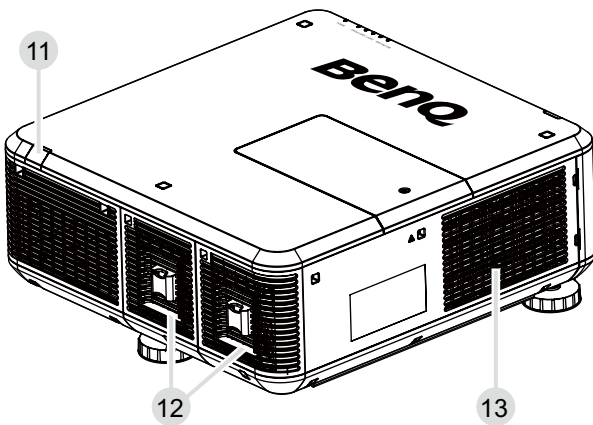

- 11. Rear IR sensor
- 12. Air exhaust and lamp door
- 13. Air intake and filter

IO panel

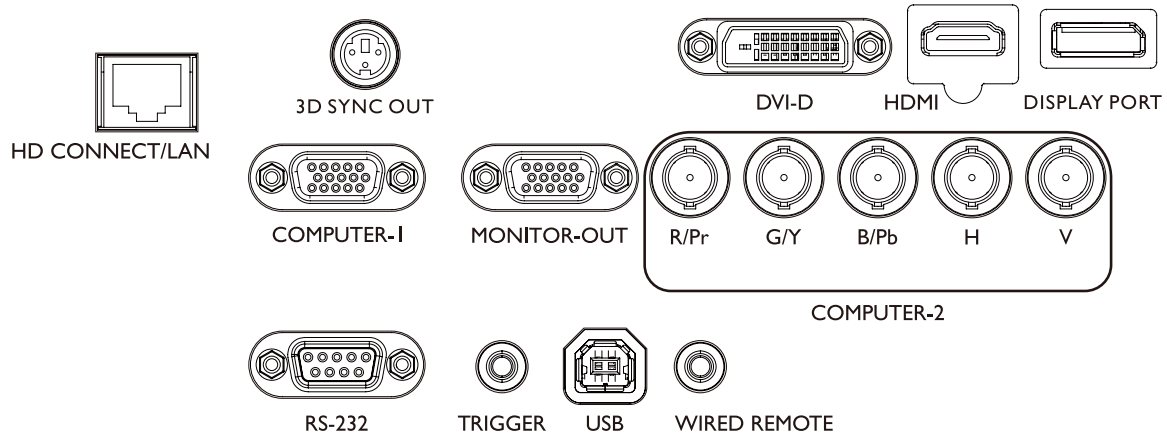

- **HD Connect/Lan**
For connection to RJ45 Cat5/Cat6 Ethernet cable to input uncompressed high-definition video (HD), control signals.
- **3D Sync Out**
Connection to 3D IR sync signal transmitter.
- **DVI-D**
Connection to DVI source.
- **HDMI**
Connection to HDMI source.
- **DisplayPort**
Connection to device or PC featuring DisplayPort.
- **Computer-1**
15-pin VGA port for connection to RGB, component HD source, or PC.
- **Monitor Out**
Connection to other display equipment for concurrent playback display.
- **Computer-2(R/Pr, G/Y, B/Pb, H, V)**
Connection to RGB or YPbPr/YCbCr output signal with BNC type input terminal.
- **RS-232**
Standard 9-pin D-sub interface for connection to PC control system and projector maintenance.
- **TRIGGER**
3.5mm mini earphone jack, employs 350mA display relay to provide 12(+/-1.5)V output and short circuit protection.
- **USB**
Maintenance exclusive port for authorized maintenance personnel only.
- **WIRE Remote**
Connection to input Niles or Xantech compatible IR repeater system.

Caution:

Make sure the port is valid before inserting a wired remote controller. The remote controller may be damaged in case of an invalid port, e.g. a wired remote controller is connected to trigger output.

Control panel and functions

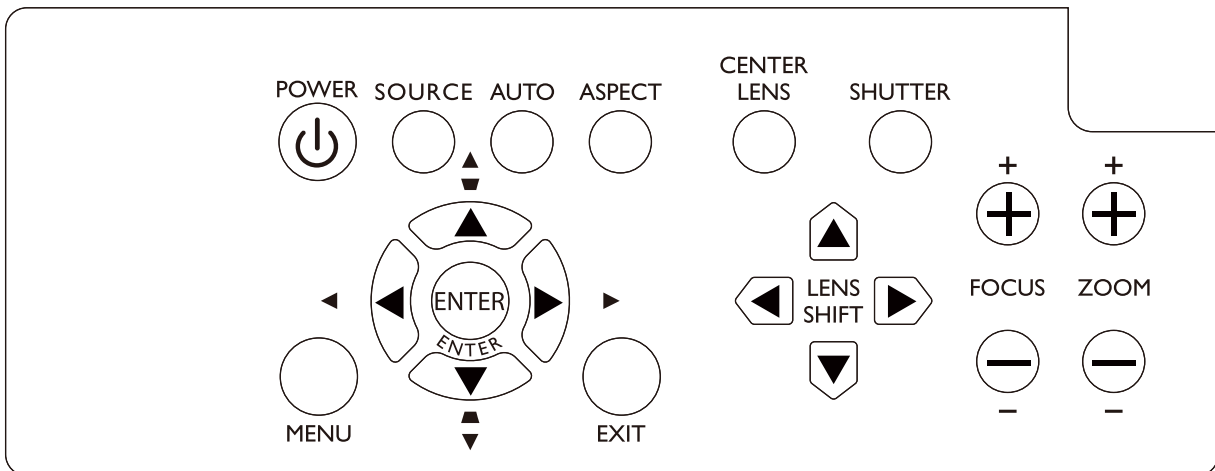

- **POWER**
Press to power on/off your projector.
- **SOURCE**
Press to select video source including HDMI, DVI, VGA, Component/BNC Composite, DisplayPort or HD Connect.
- **AUTO**
Press to execute auto signal sync.
- **ASPECT**
Press and hold this button to switch aspect ratio of current image.
- **MENU**
Press to hide or display OSD menu.
- **ENTER**
Press to select, accept or change settings.
- **EXIT**
Press to go back to last menu or exit OSD menu.
- **CENTER LENS**
Press to center the lens and reset its shift, focus and zoom parameters.

Note

The lens memory requires precise lens parameter adjustments. Please re-run the **Center Lens** function once you install the lens.

- **SHUTTER**
Press to open/close the shutter.
- **LENS SHIFT**
Press to move lens move up, down, left and right.
- **FOCUS**
Press to adjust focus of projection image.
- **ZOOM**
Press to zoom in and out on projection image.

Remote control and functions

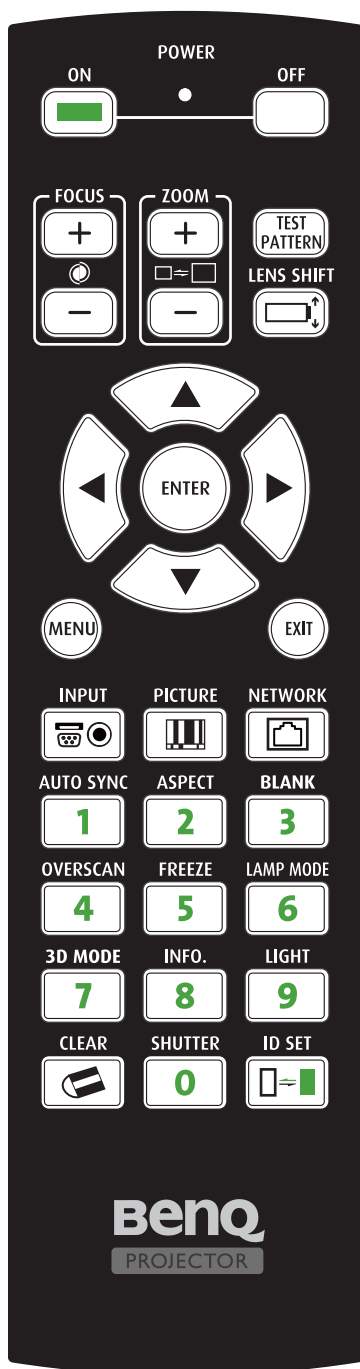

- **ON**
Press to power projector.
- **OFF**
Press to power off projector.
- **FOCUS +/-**
Press to adjust focus of projection image.
- **ZOOM +/-**
Press to zoom in and out on projection image.
- **TEST PATTERN**
Press to display test image. Press continuously to scroll through available ones. Press MENU key to exit to projection image.
- **LENS SHIFT**
Press to move lens move up, down, left and right.
- **ENTER**
Press to select or accept settings.
- **MENU**
Press to hide or display OSD menu.
- **EXIT**
Press to go back to last menu or exit OSD menu.
- **INPUT**
Press to select input source.
- **PICTURE**
Press to display Picture menu.
- **NETWORK**
Press to display Network menu.
- **AUTO SYNC**
Press to execute auto signal sync.
- **ASPECT**
Press continuously to scroll through individual aspect ratio.
- **Blank**
Press to pause projection.
- **OVERSCAN**
Press to select overscan mode.
- **FREEZE**
Press to toggle switch between freeze and unfreeze.
- **LAMP MODE**
Press to display OSD menu to select desired lamp mode.
- **3D MODE**
Press to display 3D setup menu.
- **INFO.**
Press to display SERVICE menu.
- **LIGHT**
Press to open backlight of remote controller.
- **CLEAR:** Not available with this model.
- **SHUTTER**
Press to open/close shutter.
- **ID SET:** Not available with this model.

Notes on remote controller operation

- Some environment factor may hamper the operation of remote controller. If so, point remote controller at the projector and repeat the operation again.
- In case the effective range of the remote controller is shortened or stops functioning, please replace the battery with a new one.
- The projector enters wired control mode automatically and cannot be controlled by the remote controller's IR signal, once the cable terminal of a remote controller is inserted in the projector's wired control port. To control the projector with the IR signal of the remote controller again, remove the wire control terminal from the projector.
- IR signal may be interrupted and rendered useless when the remote controller is exposed to bright sunlight or fluorescent light. Make sure the installation environment is proper for IR remote controller.

Remote control operation

- Make sure that there is nothing positioned between the remote control and the infrared (IR) sensors on the projector that might obstruct the IR beam from the remote control reaching the projector.
- The effective range of the remote control is up to 7 meters, and at an angle within 30 degrees of the IR beam. Always aim straight at the projector, however most screens will also reflect the IR beam to the projector.

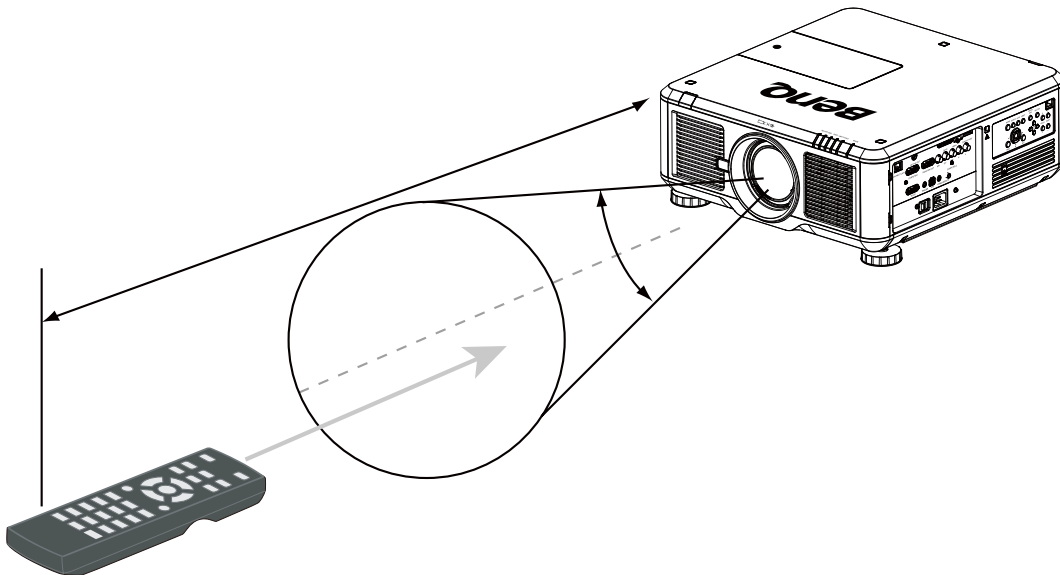

Caution:

DO NOT expose your remote controller to high temperatures or moisture or it may function abnormally.

Setup and Operation

Install remote controller battery

1. To open the battery cover, turn the remote control over to view its back, push on the finger grip on the cover and slide it up in the direction of the arrow as illustrated. The cover will slide off.
2. Remove any existing batteries (if necessary) and install two new AA batteries observing the battery polarities as indicated in the base of the battery compartment. Positive (+) goes to positive and negative (-) goes to negative.
3. Refit the cover by aligning it with the case and sliding it back up into position. Stop when it clicks into place.

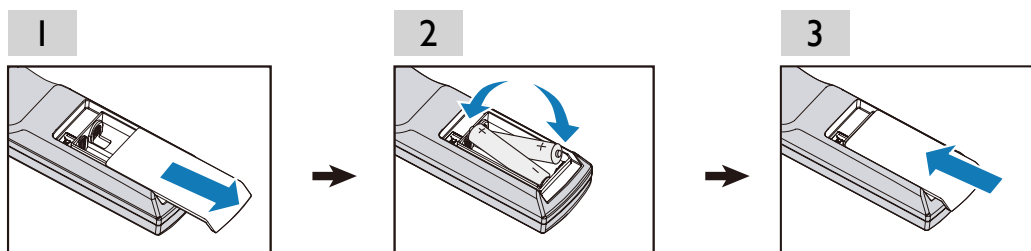

Precautions relating to batteries

- Do not mix old batteries with new ones, or mix different types of batteries.
- Avoid leaving the remote control and batteries in an excessive hot or humid environment like the kitchen, bathroom, sauna, sunroom, or in a closed car.
- Dispose of used batteries according to the battery manufacturer's instructions and local environment regulations for your region.
- If the remote control will not be used for an extended period of time, remove the batteries to avoid damage to the control from possible battery leakage.

Connecting to the projector

If the path between the remote control and the projector is obstructed or remote control operation is disrupted by certain high-frequency fluorescent lights, you can connect to the projector with M3 stereo mini jack cable to operate the projector.

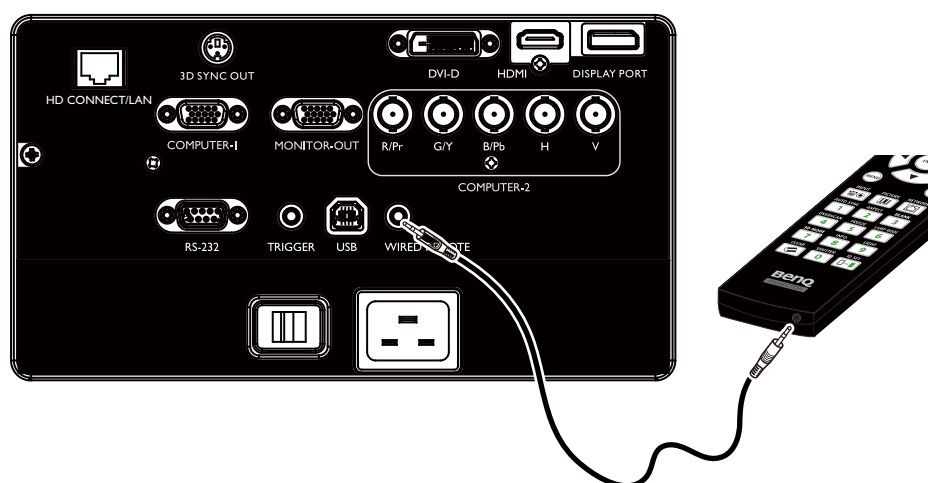

Projection lens selection and Installation



Note:

When installing the lens into the projector, be sure to remove the lens cap from the back of the optional lens before installing the optional lens into the projector. Failure to do so will cause damage to the projector.

Installing or removing the optional lens

Installing the new lens

1. Remove the lens cap.

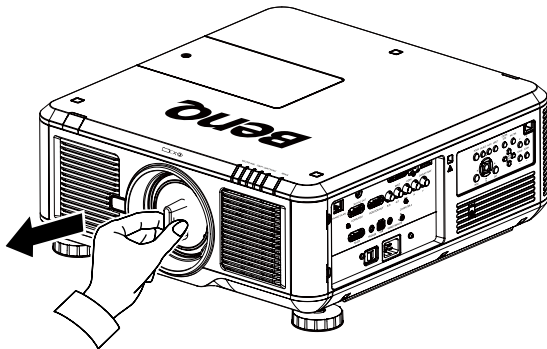

2. Insert the Lens with arrow mark then rotate the Lens clockwise until click sound twice.

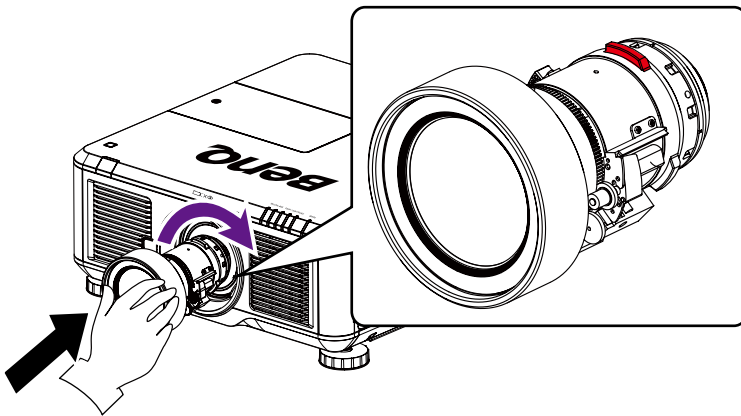

3. Using the anti-theft screw to prevent theft of the lens. Tighten the supplied anti-theft screw on the front bottom.

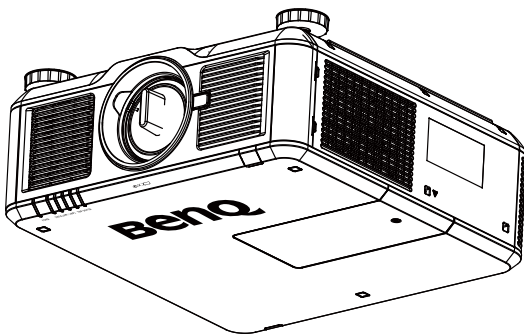

Removing the existing lens from the projector

1. Push the Lens Release button all the way in and rotate the lens counterclockwise, the existing lens will be disengaged.

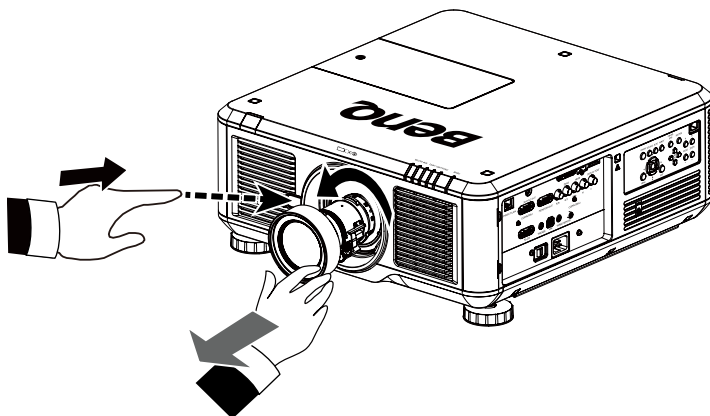

2. Pull out the existing lens slowly.

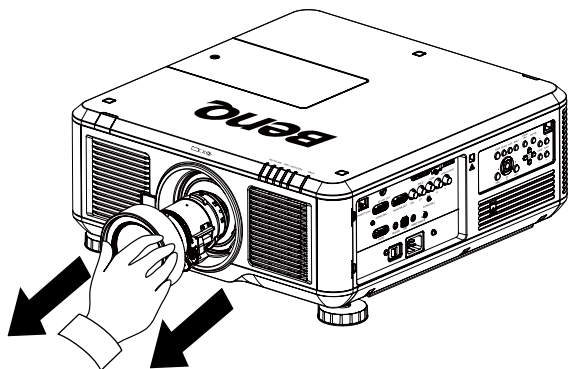

Note:

- Do not shake or place excessive pressure on the projector or the lens components as the projector and lens components contain precision parts.
- Before removing or installing the lens, be sure to turn off the projector, wait until the cooling fans stop, and turn off the main power switch.
- Do not touch the lens surface when removing or installing the lens.
- Keep fingerprints, dust or oil off the lens surface. Do not scratch the lens surface.
- If you remove and store the lens, attach the lens cap to the projector to keep off dust and dirt.

Choosing a location

Your projector is designed to be installed in one of four possible installation locations. Your room layout or personal preference will dictate which installation location you select. Take into consideration the size and position of your screen, the location of a suitable power outlet, as well as the location and distance between the projector and the rest of your equipment.

1. Front Table:

Select this location with the projector placed near the floor in front of the screen. This is the most common way to position the projector for quick setup and portability.

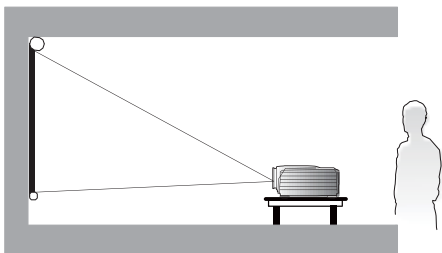

3. Rear Table:

Select this location with the projector placed near the floor behind the screen. Note that a special rear projection screen is required.

*Set Rear after you turn the projector on.

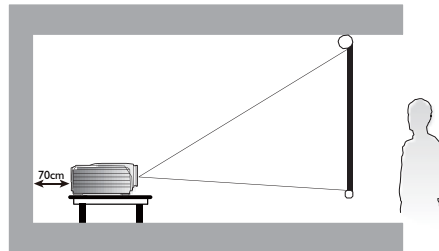

2. Front Ceiling:

Select this location with the projector suspended from the ceiling in front of the screen. Purchase the BenQ Projector Ceiling Mount Kit from your dealer to mount your projector on the ceiling.

*Set Ceiling Front after you turn the projector on.

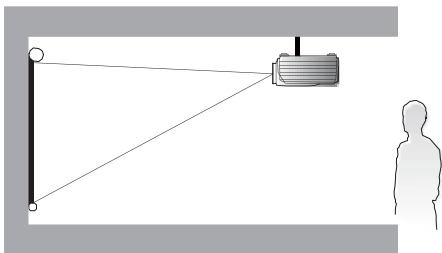

4. Rear Ceiling:

Select this location with the projector suspended from the ceiling behind the screen.

Note that a special rear projection screen and the BenQ Projector Ceiling Mount Kit are required for this installation location.

*Set Ceiling Rear after you turn the projector on.

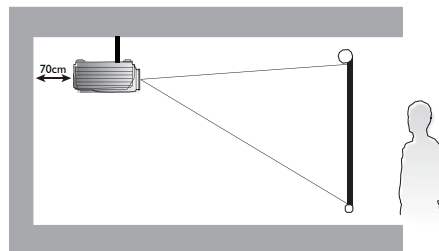

*To set the projector position:

Press MENU and then press ◀/▶ to select ALIGNMENT menu.

Press ▲/▼ to highlight Projector Installation and press ◀/▶ until the correct position is selected.

Note:

- Ceiling installation must be done by a qualified professional. Contact your dealer for more information. It is not recommended you install the projector yourself.
- Only use the projector on a solid, level surface. Serious injury and damage can occur if the projector is dropped.
- Do not use the projector in an environment where extreme temperature occurs. The projector must be used at temperatures between 41 degrees Fahrenheit (5 degrees Celsius) and 104 degrees Fahrenheit (40 degrees Celsius).
- Screen damage will occur if the projector is exposed to moisture, dust or smoke.
- Do not cover the vents on the projector. Proper ventilation is required to dissipate heat. Damage to the projector will occur if the vents are covered

Projection distance and screen size

Example of PW9620 using Standard lens:

The further your projector is from the screen or wall, the larger the image. The minimum size the image can be is approximately 40 inches (1 m) measured diagonally when the projector is roughly 79.8 inches (2.03 m) from the wall or screen. The largest the image can be is 500 inches (12.7 m) when the projector is about 1028 inches (26.11 m) from the wall or screen.

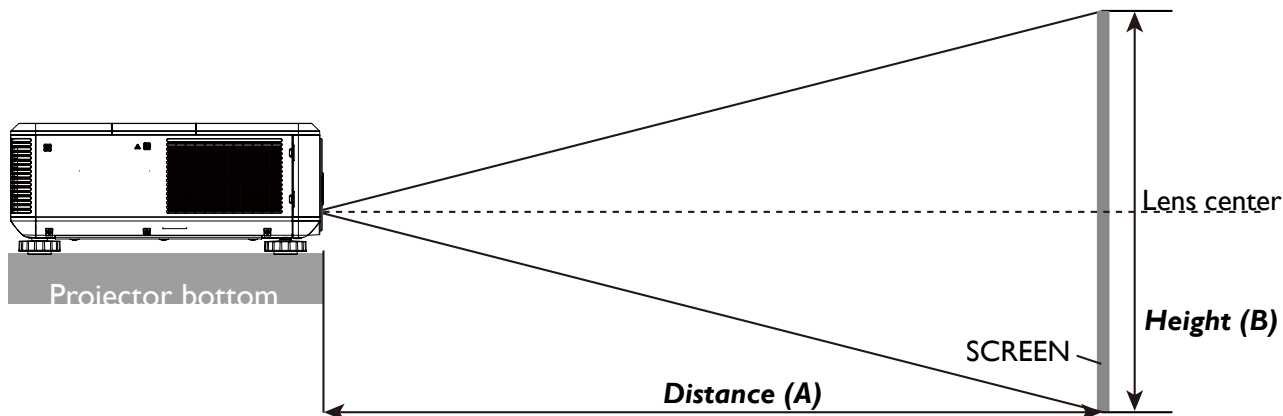

PU9730

Screen Size			5JJAM37.01 I		5JJAM37.02 I		5JJAM37.00 I		5JJAM37.05 I										
			Wide Fix Lens		Wide Zoom Lens		STD Lens		Semi long Zoom I										
Diagonal	Width		Height(B)		Distance(A)														
					N/A		Wide		Tele		Wide		Tele						
(inch)	(m)	(inch)	(m)	(inch)	(m)	(inch)	(m)	(inch)	(m)	(inch)	(m)	(inch)	(m)	(inch)	(m)				
40	1.02	34	0.86	21	0.54	25.1	0.64	41.4	1.05	59.9	1.52	57.2	1.45	75.8	1.93	73.6	1.87	124.1	3.15
50	1.27	42	1.08	26	0.67	31.8	0.81	52.3	1.33	75.4	1.92	72.1	1.83	95.5	2.42	92.9	2.36	155.9	3.96
60	1.52	51	1.29	32	0.81	38.5	0.98	63.1	1.60	90.9	2.31	87.1	2.21	115.1	2.92	112.1	2.85	187.8	4.77
80	2.03	68	1.72	42	1.08	52.0	1.32	84.9	2.16	121.8	3.09	117.0	2.97	154.3	3.92	150.5	3.82	251.4	6.39
100	2.54	85	2.15	53	1.35	65.5	1.66	106.6	2.71	152.7	3.88	147.0	3.73	193.5	4.92	188.9	4.80	315.0	8.00
120	3.05	102	2.58	64	1.62	78.9	2.01	128.4	3.26	183.6	4.66	176.9	4.49	232.8	5.91	227.6	5.78	378.6	9.62
150	3.81	127	3.23	79	2.02	99.1	2.52	161.0	4.09	230.0	5.84	221.8	5.63	291.6	7.41	285.0	7.24	474.1	12.04
180	4.57	153	3.88	95	2.42	119.3	3.03	193.6	4.92	276.4	7.02	266.7	6.77	350.5	8.90	342.6	8.70	569.5	14.47
200	5.08	170	4.31	106	2.69	132.8	3.37	215.3	5.47	307.3	7.81	296.6	7.53	389.7	9.90	381.0	9.68	633.1	16.08
300	7.62	254	6.46	159	4.04	200.1	5.08	324.0	8.23	461.9	11.73	446.3	11.34	585.9	14.9	573.2	14.56	951.2	24.16
400	10.16	339	8.62	212	5.38	267.4	6.79	432.7	10.99	616.6	15.66	595.9	15.14	782.3	19.87	765.3	19.44	1269.7	32.25
500	12.70	424	10.77	265	6.73	334.8	8.50	541.5	13.75	771.2	19.59	745.6	18.94	978.3	24.85	957.4	24.32	1587.8	40.33

Screen Size			5JJAM37.03 I		5JJAM37.04 I		5JJAM37.06 I										
			Long Zoom 1 Lens		Long zoom 2 Lens		Ultra Wide zoom Lens										
Diagonal	Width(C)		Height(B)		Distance(A)												
					Wide		Tele		Wide		Tele						
(inch)	(m)	(inch)	(m)	(inch)	(m)	(inch)	(m)	(inch)	(m)	(inch)	(m)	(inch)	(m)				
40	1.02	34	0.86	21	0.54	118.7	3.01	181.0	4.60	173.9	4.42	277.7	7.05	24.5	0.62	31.1	0.79
50	1.27	42	1.08	26	0.67	149.7	3.80	227.6	5.78	220.2	5.59	350.0	8.89	31.1	0.79	39.2	1.00
60	1.52	51	1.29	32	0.81	180.7	4.59	274.1	6.96	266.6	6.77	422.3	10.73	37.6	0.96	47.4	1.20
80	2.03	68	1.72	42	1.08	242.7	6.16	367.3	9.33	359.4	9.13	567.0	14.40	50.8	1.29	63.8	1.62
100	2.54	85	2.15	53	1.35	304.3	7.73	460.4	11.70	452.1	11.48	711.6	18.07	63.9	1.62	80.2	2.04
120	3.05	102	2.58	64	1.62	366.7	9.31	553.6	14.06	544.9	13.84	856.2	21.75	77.1	1.96	96.6	2.45
150	3.81	127	3.23	79	2.02	459.4	11.67	693.3	17.61	684.0	17.37	1073.1	27.26	96.8	2.46	121.1	3.08
180	4.57	153	3.88	95	2.42	552.4	14.03	833.0	21.16	823.1	20.91	1290.1	32.77	116.5	2.96	145.7	3.70
200	5.08	170	4.31	106	2.69	614.7	15.6	926.4	23.53	915.9	23.26	1434.7	36.44	129.7	3.29	162.1	4.12
300	7.62	254	6.46	159	4.04	924.0	23.47	1392.1	35.36	1379.6	35.04	2157.8	54.81	195.4	4.96	244.0	6.20
400	10.16	339	8.62	212	5.38	1233.9	31.34	1857.9	47.19	1843.3	46.82	2880.9	73.18	261.2	6.63	325.9	8.28
500	12.70	424	10.77	265	6.73	1543.7	39.21	2323.6	59.02	2307.1	58.60	3604.0	91.54	326.9	8.30	407.7	10.36

PW9620

Screen Size						5J,JAM37.01 I		5J,JAM37.02 I				5J,JAM37.00 I				5J,JAM37.05 I			
						Wide Fix Lens		Wide Zoom Lens				STD Lens				Semi long Zoom I			
Diagonal		Width		Height(B)		Distance(A)													
						N/A		Wide		Tele		Wide		Tele		Wide		Tele	
(inch)	(m)	(inch)	(m)	(inch)	(m)	(inch)	(m)	(inch)	(m)	(inch)	(m)	(inch)	(m)	(inch)	(m)	(inch)	(m)	(inch)	(m)
40	1.02	34	0.86	21	0.54	26.4	0.67	43.6	1.11	63.1	1.60	60.2	1.53	79.8	2.03	77.6	1.97	130.5	3.31
50	1.27	42	1.08	26	0.67	33.5	0.85	55.0	1.40	79.3	2.01	75.9	1.93	100.4	2.55	97.8	2.48	163.9	4.16
60	1.52	51	1.29	32	0.81	40.5	1.03	66.4	1.69	95.5	2.43	91.7	2.33	121.0	3.07	117.9	3.00	197.3	5.01
80	2.03	68	1.72	42	1.08	54.7	1.39	89.3	2.27	128.0	3.25	123.1	3.13	162.3	4.12	158.3	4.02	264.1	6.71
100	2.54	85	2.15	53	1.35	68.8	1.75	112.1	2.85	160.5	4.08	154.5	3.93	203.5	5.17	198.7	5.05	330.9	8.41
120	3.05	102	2.58	64	1.62	82.9	2.11	135.0	3.43	193.0	4.90	186.0	4.72	244.7	6.22	239.0	6.07	397.7	10.10
150	3.81	127	3.23	79	2.02	104.1	2.64	169.2	4.30	241.7	6.14	233.1	5.92	306.5	7.79	299.6	7.61	498.0	12.65
180	4.57	153	3.88	95	2.42	125.3	3.18	203.5	5.17	290.4	7.38	280.3	7.12	368.4	9.36	360.1	9.15	598.2	15.19
200	5.08	170	4.31	106	2.69	139.4	3.54	226.4	5.75	322.9	8.20	311.7	7.92	409.6	10.40	400.5	10.17	665.0	16.89
300	7.62	254	6.46	159	4.04	210.0	5.33	340.6	8.65	485.3	12.33	468.9	11.91	615.7	15.64	602.3	15.30	999.0	25.38
400	10.16	339	8.62	212	5.38	280.6	7.13	454.8	11.55	647.7	16.45	626.1	15.90	821.9	20.88	804.1	20.42	1333.1	33.86
500	12.70	424	10.77	265	6.73	351.2	8.92	569.0	14.45	810.1	20.58	783.3	19.90	1028.0	26.11	1005.9	25.55	1667.1	42.35

Screen Size						5J,JAM37.03 I				5J,JAM37.04 I				5J,JAM37.06 I			
						Long Zoom I Lens				Long zoom 2 Lens				Ultra Wide zoom Lens			
Diagonal		Width		Height(B)		Distance(A)											
						Wide		Tele		Wide		Tele		Wide		Tele	
(inch)	(m)	(inch)	(m)	(inch)	(m)	(inch)	(m)	(inch)	(m)	(inch)	(m)	(inch)	(m)	(inch)	(m)	(inch)	(m)
40	1.02	34	0.86	21	0.54	124.9	3.17	190.3	4.83	183.3	4.65	292.2	7.42	25.8	0.65	32.8	0.83
50	1.27	42	1.08	26	0.67	157.5	4.00	239.2	6.08	232.0	5.89	368.1	9.35	32.7	0.83	41.4	1.05
60	1.52	51	1.29	32	0.81	190.1	4.83	288.1	7.32	280.7	7.13	444.0	11.28	39.6	1.00	50.0	1.27
80	2.03	68	1.72	42	1.08	255.2	6.48	385.9	9.80	378.1	9.60	595.9	15.13	53.3	1.35	67.3	1.71
100	2.54	85	2.15	53	1.35	320.3	8.14	483.7	12.29	475.6	12.08	747.7	18.99	67.1	1.70	84.5	2.15
120	3.05	102	2.58	64	1.62	385.5	9.79	581.5	14.77	573.0	14.55	899.6	22.85	80.9	2.05	101.8	2.59
150	3.81	127	3.23	79	2.02	483.2	12.27	728.2	18.50	719.1	18.27	1127.3	28.63	101.6	2.58	127.6	3.24
180	4.57	153	3.88	95	2.42	580.9	14.75	874.9	22.22	865.3	21.98	1355.1	34.42	122.2	3.10	153.5	3.90
200	5.08	170	4.31	106	2.69	646.0	16.41	972.7	24.71	962.7	24.45	1506.9	38.28	136.0	3.45	170.8	4.34
300	7.62	254	6.46	159	4.04	971.7	24.68	1461.8	37.13	1449.9	36.83	2266.2	57.56	204.9	5.20	257.0	6.53
400	10.16	339	8.62	212	5.38	1297.3	32.95	1950.8	49.55	1937.1	49.20	3025.4	76.85	273.8	6.95	343.2	8.72
500	12.70	424	10.77	265	6.73	1623.0	41.22	2439.8	61.97	2424.2	61.58	3784.7	96.13	342.7	8.70	429.4	10.91

Screen Size						5JJAM37.01 I		5JJAM37.02 I				5JJAM37.00 I				5JJAM37.05 I			
						Wide Fix Lens		Wide Zoom Lens				STD Lens				Semi long Zoom I			
Diagonal		Width		Height(B)		Distance(A)													
						N/A		Wide		Tele		Wide		Tele		Wide		Tele	
(inch)	(m)	(inch)	(m)	(inch)	(m)	(inch)	(m)	(inch)	(m)	(inch)	(m)	(inch)	(m)	(inch)	(m)	(inch)	(m)	(inch)	(m)
40	1.02	32	0.81	24	0.61	24.5	0.62	40.4	1.03	58.5	1.49	55.8	1.42	74.1	1.88	71.9	1.83	121.3	3.08
50	1.27	40	1.02	30	0.76	31.0	0.79	51.0	1.30	73.6	1.87	70.4	1.79	93.2	2.37	90.7	2.30	152.4	3.87
60	1.52	48	1.22	36	0.91	37.6	0.96	61.6	1.57	88.8	2.25	85.1	2.16	112.4	2.86	109.5	2.78	183.5	4.66
80	2.03	64	1.63	48	1.22	50.8	1.29	82.9	2.11	119.0	3.02	114.3	2.90	150.8	3.83	147.0	3.73	245.7	6.24
100	2.54	80	2.03	60	1.52	63.9	1.62	104.1	2.65	149.2	3.79	143.5	3.65	189.1	4.80	184.6	4.69	307.9	7.82
120	3.05	96	2.44	72	1.83	77.1	1.96	125.4	3.18	179.4	4.56	172.8	4.39	227.4	5.78	222.1	5.64	370.1	9.40
150	3.81	120	3.05	90	2.29	96.8	2.46	157.3	3.99	224.8	5.71	216.7	5.50	285.0	7.24	278.4	7.07	463.4	11.77
180	4.57	144	3.66	108	2.74	116.6	2.96	189.1	4.80	270.1	6.86	260.5	6.62	342.5	8.70	334.8	8.50	556.7	14.14
200	5.08	160	4.06	120	3.05	129.7	3.30	210.4	5.34	300.3	7.63	289.8	7.36	380.8	9.67	372.3	9.46	618.9	15.72
300	7.62	240	6.1	180	4.57	195.5	4.97	316.6	8.04	451.5	11.47	436.0	11.07	572.6	14.54	560.0	14.23	930.0	23.62
400	10.16	320	8.13	240	6.1	261.3	6.64	422.9	10.74	602.6	15.31	582.2	14.79	764.3	19.41	747.8	18.99	1241.0	31.52
500	12.70	400	10.16	300	7.62	327.1	8.31	529.1	13.44	753.7	19.14	728.5	18.50	956.1	24.28	935.5	23.76	1552.0	39.42

Screen Size						5JJAM37.03 I				5JJAM37.04 I				5JJAM37.06 I			
						Long Zoom 1 Lens				Long zoom 2 Lens				UltraWide zoom Lens			
Diagonal		Width		Height(B)		Distance(A)											
						Wide		Tele		Wide		Tele		Wide		Tele	
(inch)	(m)	(inch)	(m)	(inch)	(m)	(inch)	(m)	(inch)	(m)	(inch)	(m)	(inch)	(m)	(inch)	(m)	(inch)	(m)
40	1.02	32	0.81	24	0.61	115.9	2.94	176.8	4.49	169.6	4.31	271.2	6.89	23.9	0.61	30.4	0.77
50	1.27	40	1.02	30	0.76	146.2	3.71	222.3	5.65	215.0	5.46	341.9	8.68	30.3	0.77	38.4	0.98
60	1.52	48	1.22	36	0.91	176.5	4.48	267.9	6.80	260.3	6.61	412.6	10.48	36.7	0.93	46.5	1.18
80	2.03	64	1.63	48	1.22	237.1	6.02	358.9	9.12	350.9	8.91	554.0	14.07	49.5	1.26	62.5	1.59
100	2.54	80	2.03	60	1.52	297.7	7.56	450.0	11.43	441.6	11.22	695.3	17.66	62.4	1.58	78.6	2.00
120	3.05	96	2.44	72	1.83	358.2	9.10	541.0	13.74	532.2	13.52	836.7	21.25	75.2	1.91	94.7	2.40
150	3.81	120	3.05	90	2.29	449.1	11.41	677.6	17.21	668.2	16.97	1048.8	26.64	94.4	2.40	118.8	3.02
180	4.57	144	3.66	108	2.74	540.0	13.72	814.2	20.68	804.1	20.42	1260.9	32.03	113.7	2.89	142.9	3.63
200	5.08	160	4.06	120	3.05	600.6	15.26	905.3	22.99	894.8	22.73	1402.2	35.62	126.5	3.21	158.9	4.04
300	7.62	240	6.1	180	4.57	903.6	22.95	1360.5	34.56	1348.0	34.24	2109.1	53.57	190.7	4.84	239.2	6.08
400	10.16	320	8.13	240	6.1	1206.6	30.65	1815.8	46.12	1801.2	45.75	2816.0	71.53	254.9	6.47	319.5	8.12
500	12.70	400	10.16	300	7.62	1509.5	38.34	2271.1	57.69	2254.3	57.26	3522.9	89.48	319.1	8.10	399.9	10.16

 Note:

- Ceiling installation must be done by a qualified professional. Contact your dealer for more information. It is not recommended you install the projector yourself.
- Only use the projector on a solid, level surface. Serious injury and damage can occur if the projector is dropped.
- Do not use the projector in an environment where extreme temperature occurs. The projector must be used at temperatures between 41 degrees Fahrenheit (5 degrees Celsius) and 104 degrees Fahrenheit (40 degrees Celsius).
- Screen damage will occur if the projector is exposed to moisture, dust or smoke.
- Do not cover the vents on the projector. Proper ventilation is required to dissipate heat. Damage to the projector will occur if the vents are covered.

Lens shift adjustable range

The adjustable range for lens shift is tabulated below and subject to the conditions listed.

 **Note:**

The drawings below apply to the standard lens only.

Desk-FrontProjection

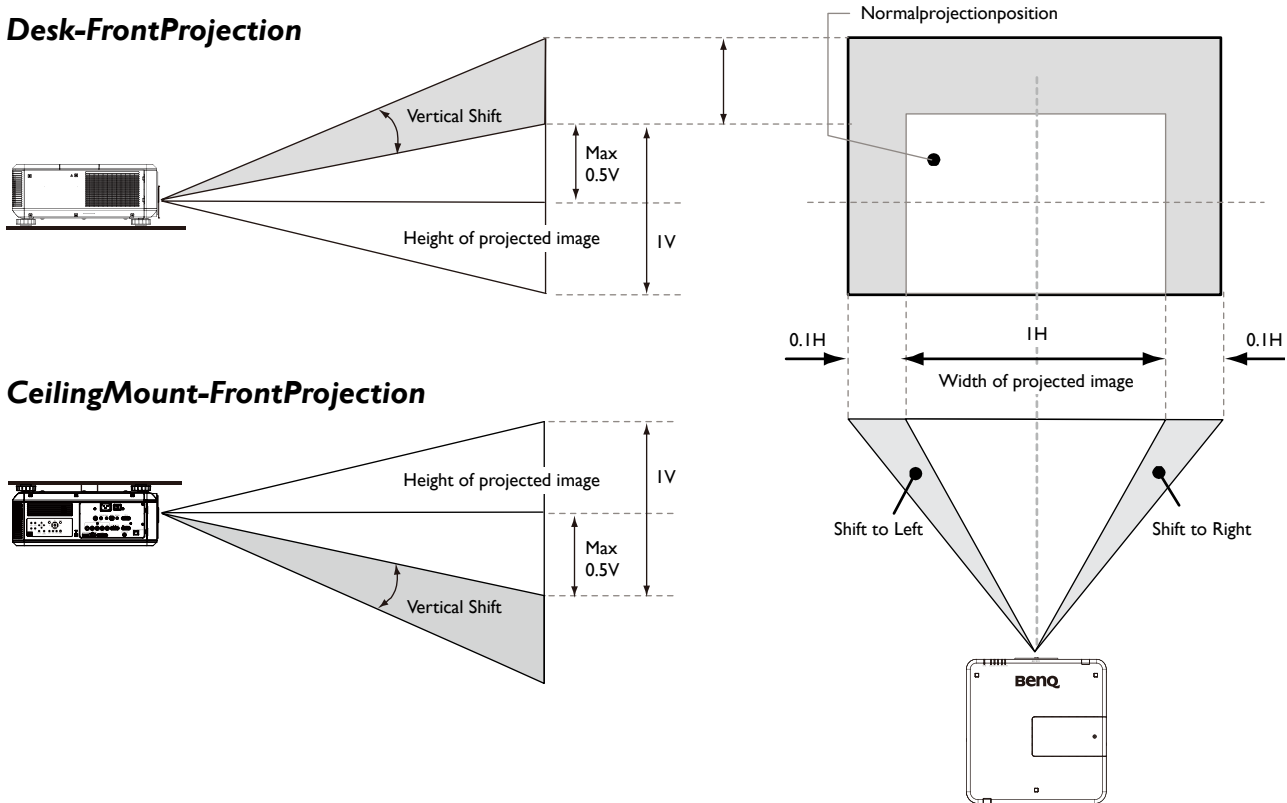

Making connections

Preparations

When connecting a signal source to the projector, be sure to:

1. Turn off all equipment before making any connections.
2. Use only the correct type cables for each source with proper type plugs.
3. Ensure that all cable plugs are firmly fitted to the equipment jacks.

Note that all cables shown in the following connection diagrams may not be supplied with the projector (See "Shipping contents" on page 7 Shipping contents). Most cables are commercially available from electronics stores.

Connect to PC

You may connect a PC to your projector with a DVI-D, HDMI, RGB or RGBHV (BNC) cable for projection, and connect an external display to your projector for concurrent viewing if the input is RGB signal.

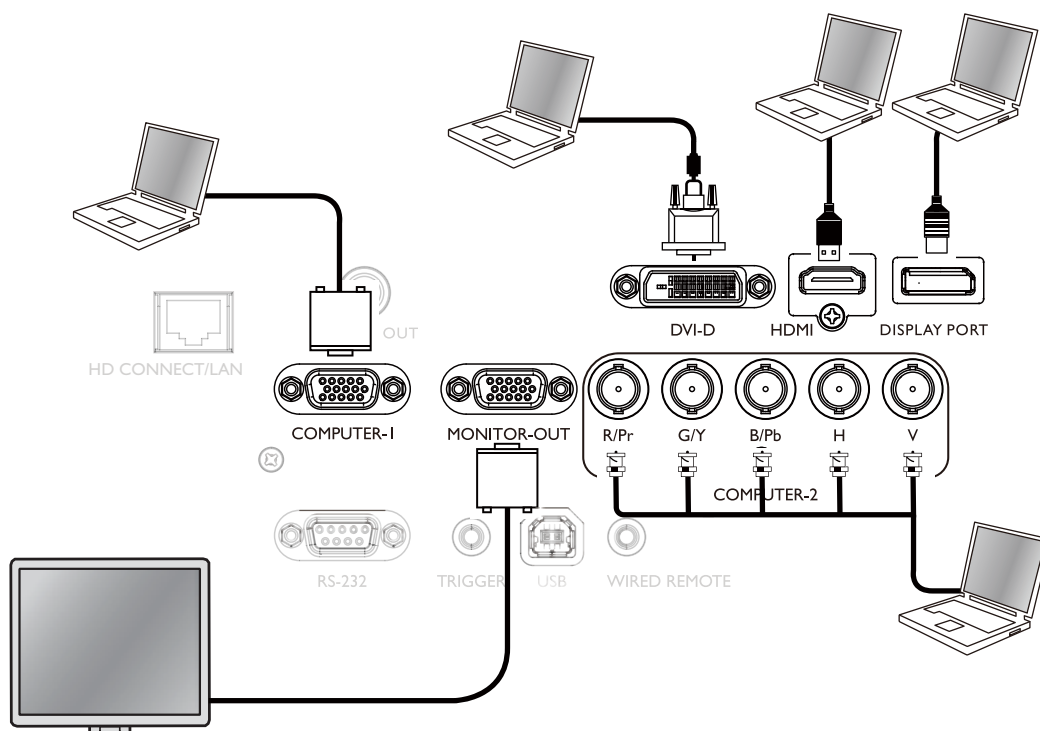

Connect to video equipment

You may connect any video equipment to your projector's input port with a DVI-D, HDMI, DisplayPort or YBPBR cable.

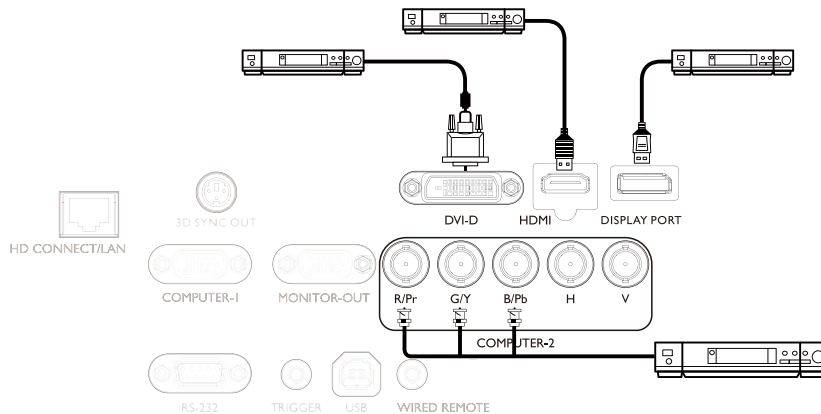

Connect to control port

Your projector features the following control ports:

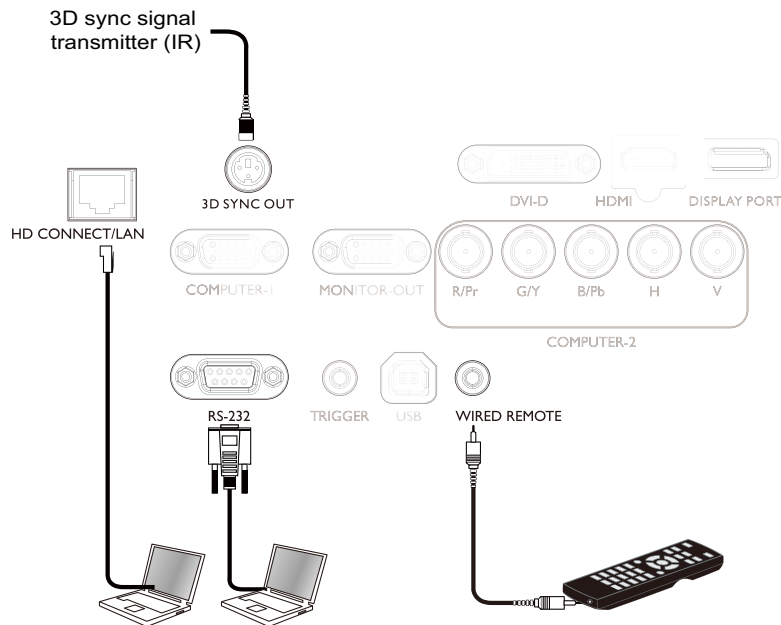

- **HD CONNECT/LAN**

Your projector supports network control with shared LAN (network control) and HD Connect.

- **RS-232 (RS-232c control)**

Your projector supports RS-232c serial control. You may connect the projector to a PC with standard 9-pin serial cable (straight through wire) for remote control.

- **Wired controller**

If the remote controller's IR signal fails to reach your projector because the two are too far apart or blocked by any obstacle, you may connect the WIRE input port of your projector to an IR remote controller or an (optional) IR repeater to expand its working area.

- **3D Sync Out**

3D IR sync signal transmitter

Caution:

- The projector enters wired control mode automatically and cannot be controlled by a remote controller's IR signal once the terminal of a remote controller is inserted in the projector's wire port. To control your projector with the IR signal of a remote controller again, remove the wire control terminal from the projector.
- Make sure the port is valid before inserting a wired remote controller. The remote controller may be damaged if a port is invalid, e.g. a wired remote controller is connected to trigger output.

Connect to screen trigger

You may connect a projector screen or other 12V trigger device to the projector and turn on trigger output in OSD Control->Trigger. The trigger port supplies the 12V signal after the projector is powered on. After the projector is powered on it outputs 12V signal be adhere to current aspect ratio and screen control settings for projector screen control.

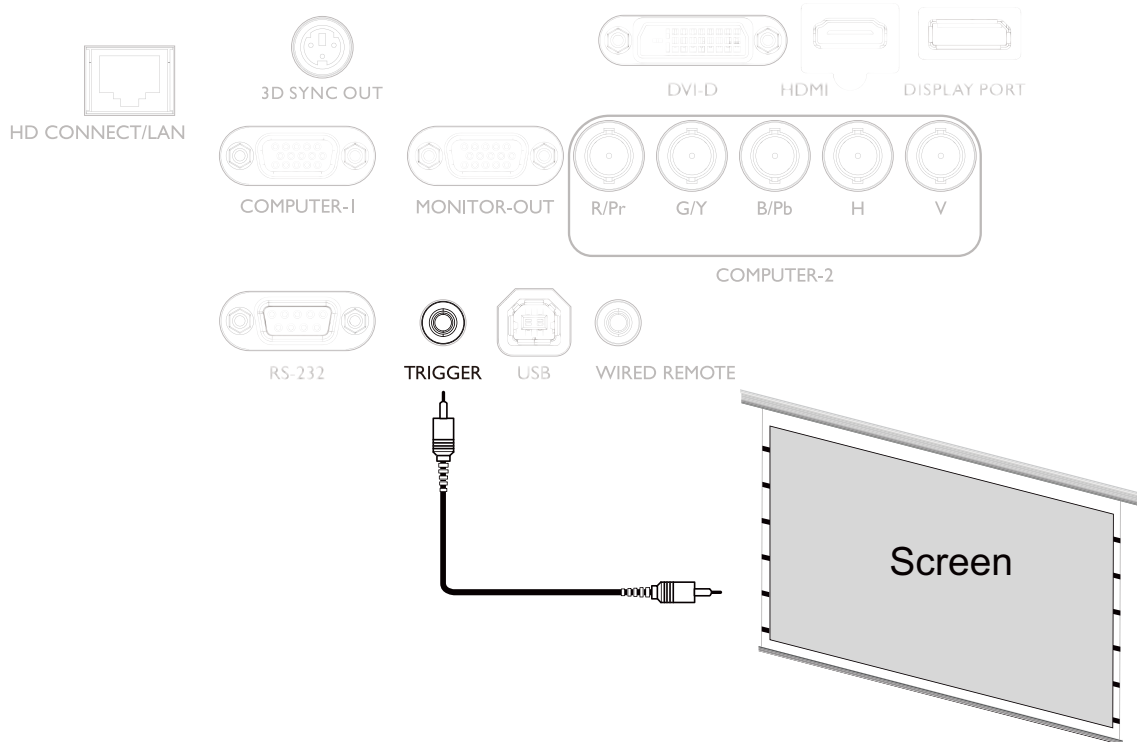

Connect to external digital transmitter

The projector features a built-in HD Connect for you to work with optional digital transmitter to send video, RS-232, LAN signal to projector with single RJ-45 cable. If the optional digital transmitter supports IR remote controller I/O, you may also send IR remote controller signal to PU9730/PW9520/PX9610 projector using the same RJ-45 cable.

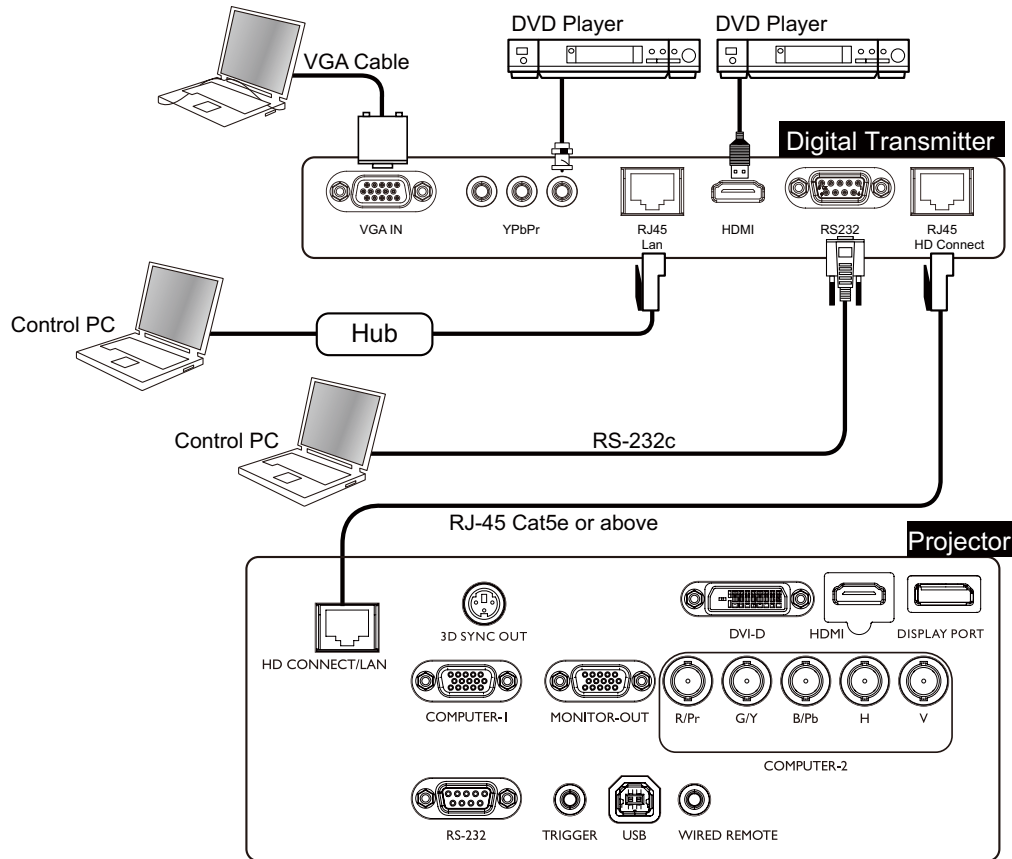

Caution:

- The HD Connect of your projector supports to video, RS-232, remote controller, and network control signal receiving but not Power over Ethernet (PoE) transmission and receiving.
- To send RS232 commands with an external digital transmitter via RJ45 cable to your projector: set Control -> RS232 -> Channel to HD Connect in OSD menu, the transmission speed is changed to 9600 by the system automatically.
- Effective transmission distance of your digital transmitter is 100 meters. Transmission over 100 meters may lead to projection screen interruption, interference, or control signal failure.
- Please use Cat.5e RJ-45 cable or better and prevent the cable from becoming twisted. Otherwise the cable may be damaged and signal transmission quality poor, reducing transmission distance and image quality.

Using the projector

Preparations

1. Plug in and turn all of the connected equipment on.
2. If not already in, plug the supplied power cable into the AC inlet on the rear of the projector.
3. Plug the power cable into a wall power outlet and turn the wall switch on.

Note:

Please use the original accessories (e.g. power cable) only with the device to avoid possible dangers such as electric shock and fire.

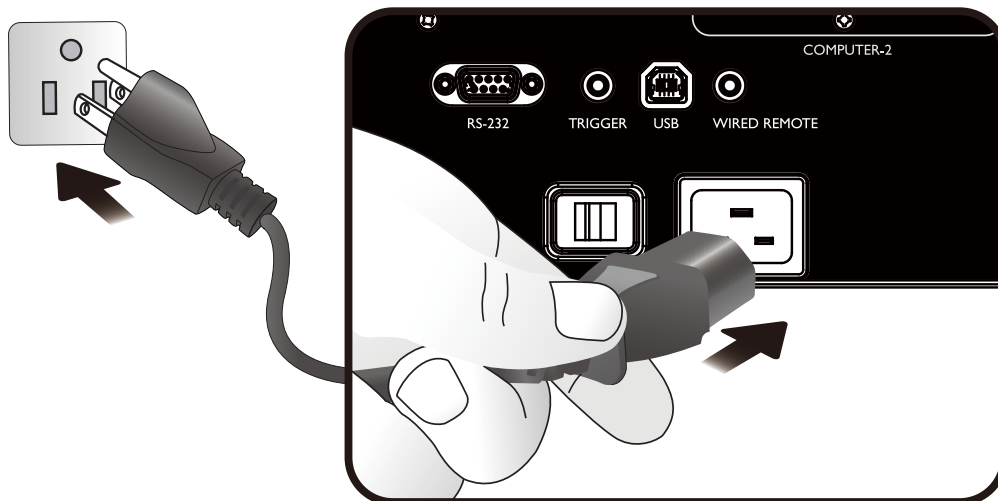

Turning the projector on or off

Once the projector is correctly located and the power cable and other connections are in place, it is important that the projector is connected and powered on correctly in order to avoid possible dangers such as electric shock and fire. Refer to the following guide to power on the projector.

1. Turn the main power switch to ON, Power light is red after power has been applied.
2. Press the POWER button on the projector or ON button on the remote control to start the projector. The Power and Lamp LED flashes green and the cooling fan start operating.
3. The projected image will be displayed on the screen for a few second while it is warming up.
4. Once the power LED is lit a solid green, the projector is ready for use.
Note: The projector will not respond to further commands while it is warming up.
5. If any of the LEDs remain flashing or blink there may be a problem with the start up. Please refer to the Troubleshooting section page 69 Troubleshooting.

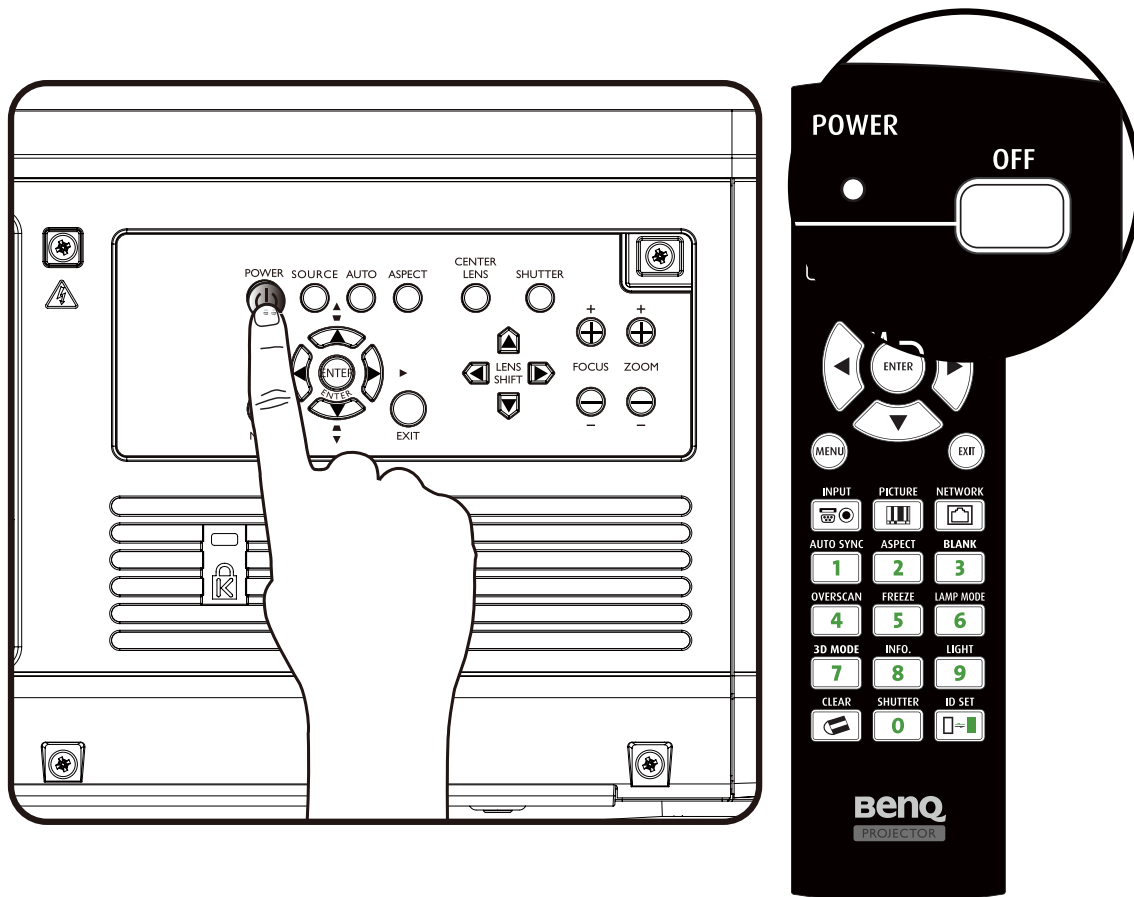

Note

If you attempt to re-start the projector shortly after shutdown, the fans may run for a few minutes to cool down. Press  Power again to start the projector after the fans stop and the Power indicator light turns orange

Selecting an input source

The projector can be connected to multiple equipment at the same time. When the projector is first turned on, it will attempt to reconnect with the input source which was in use when the projector was last shut down.

The Input Source can be selected from the projector's control panel or from the remote control. Refer to the following guide to select the desired input source

1. Press INPUT key on the remote control or control panel to display SOURCE Menu.

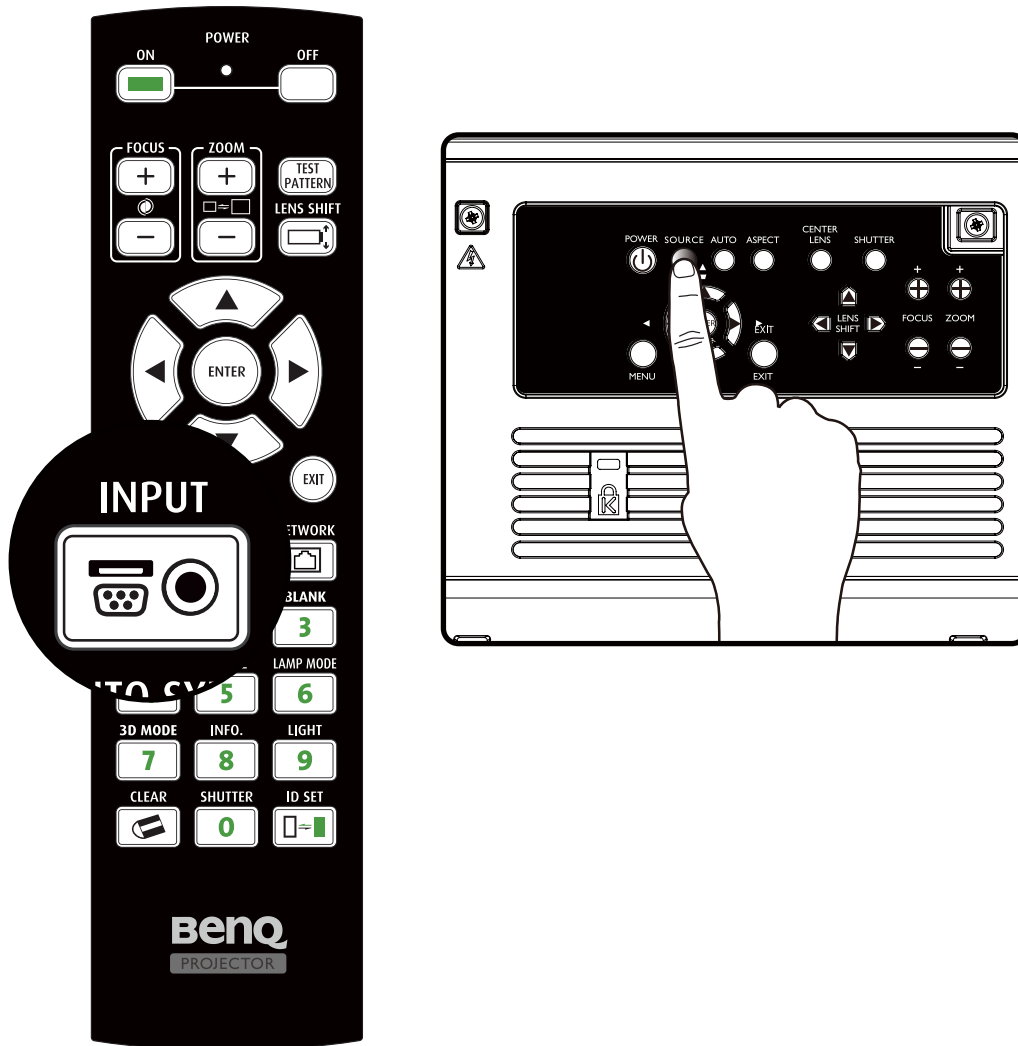

2. Select your desired input source via ▲/▼ key.
3. Press ENTER key to confirm the input selection, it will take few seconds to detect the desired input signal and display the projected image.
Press RETURN key to projected image if you want to keep current input source.

Using the menus

The projector is equipped with multilingual On-Screen Display (OSD) for making various adjustment and settings, below is the overview of the OSD menu.

To use the OSD menu, please set the OSD menu to your familiar language.

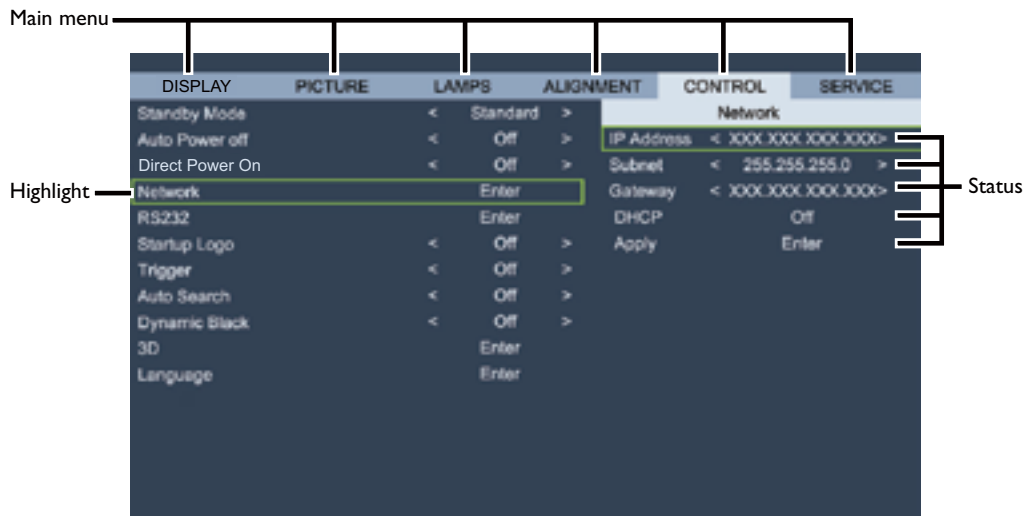

Adjusting the projected Image

Adjusting the image position

The projected image position and Size can be adjusted manually from the control panel or the remote control unit. Refer to the following guides to adjust Picture Position manually.

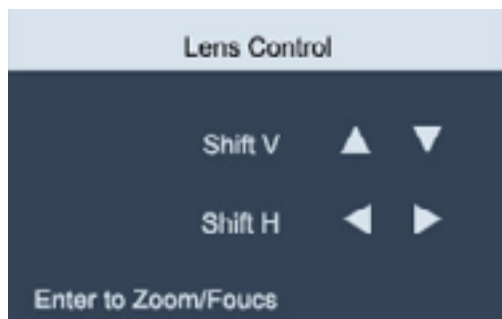

1. Press the LENS SHIFT key on the projector in any direction or LENS SHIFT key on the remote control to bring up the Lens Shift window.
2. Press the directional key as required to shift the image. Releasing the directional key will recenter the cursor.

Fine-tuning the image size and clarity

1. Press the ZOOM + or ZOOM- button on the control panel or the remote control to adjust the projected image as you desired.
2. Sharpen the picture by pressing FOCUS+ or FOCUS- button on the control panel or the remote control.

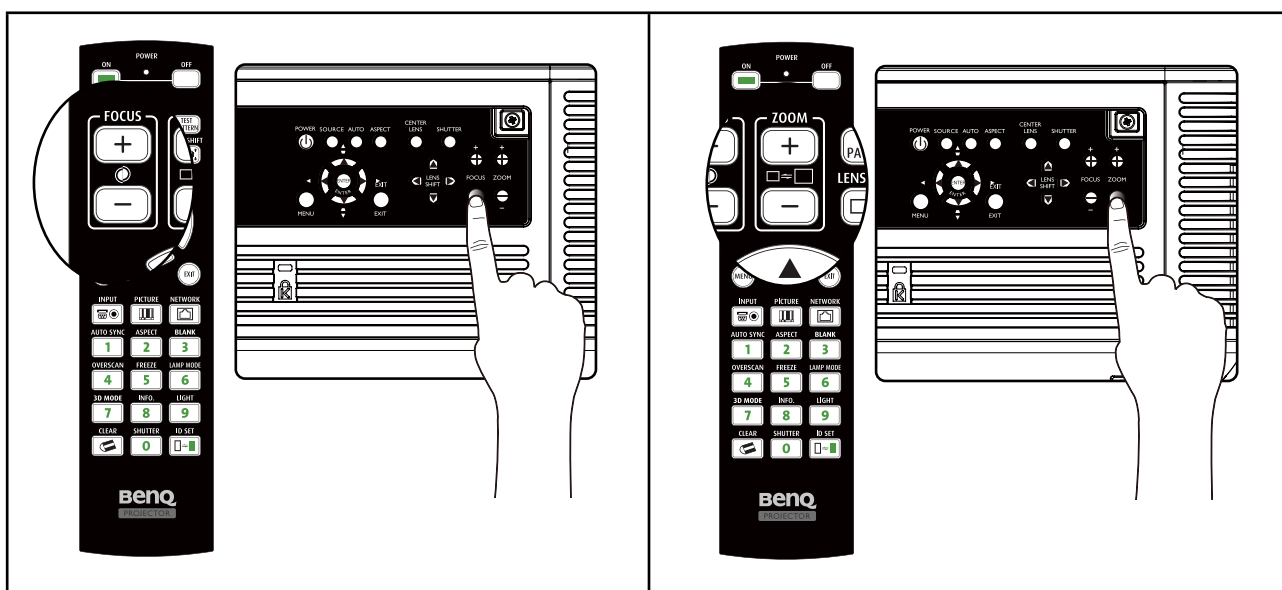

Adjusting the projection angle

There are three adjuster feet on the bottom of the projector, these can be used if necessary to change the projection angle. Screw the feet in or out as appropriate to aim and level the projection angle.

1. Twist the adjusters clockwise to raise the level of the projector.

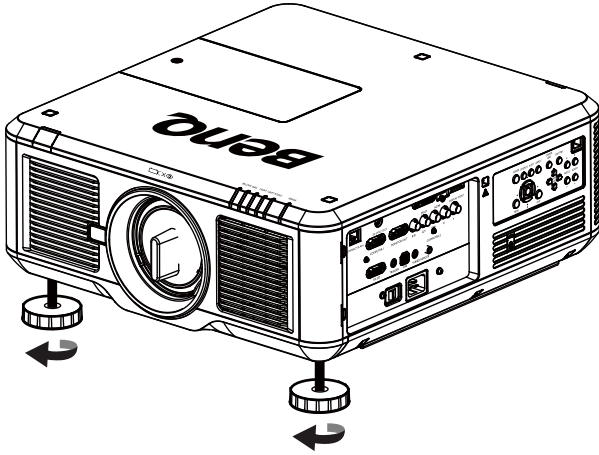

2. To lower the level of the projector, lift the projector and twist the adjusters counter clockwise.

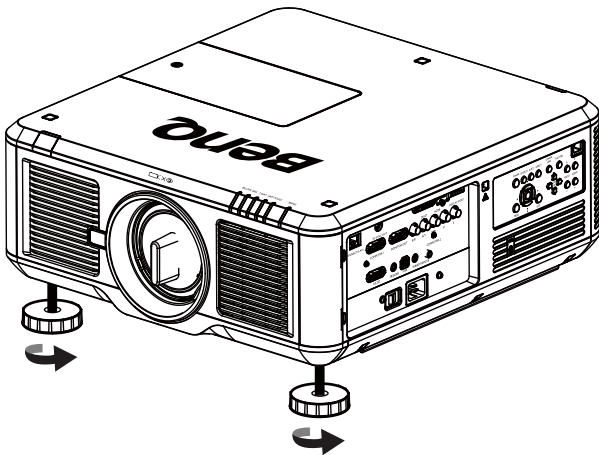

Correcting picture distortion

When the image is projected either from the top or from the bottom towards the screen at angle, the image becomes distorted trapezoidally. Keystone function in the ALIGNMENT>Keystone can be used to correct trapezoidal distortion, press ◀/▶ button to correct trapezoidal distortion till you are satisfied with the shape.



When the values reach their maximum or minimum with repeated key presses, the picture's shape will stop changing. You will not be able to change the picture further in that direction.

Auto-adjusting the image

In some cases, you may need to optimize the RGB picture quality. To do this, press AUTO key on the remote control or control panel, the built-in Intelligent Auto Adjustment function will re-adjust the values of Frequency and Clock to provide the best picture quality.

Note:

This function is only available when a PC signal (analog RGB) is selected.

Turning off the projector

If the projector is no longer required, it is important to shut it down correctly to avoid damage or unnecessary wear and tear to the projector. Refer to the following guide to turn the projector Off.

- Do not unplug the power cable from the wall outlet or projector when the projector is powered on, it may cause damage to the AC IN connector of the projector and (or) the prong plug of the power cable.
 - Do not turn off the AC power supply within 10 seconds of making adjustment or setting changes and closing the menu, it may cause loss of adjustments and settings and return to default.
1. Press the **POWER** button on the control panel or OFF button on the remote control.

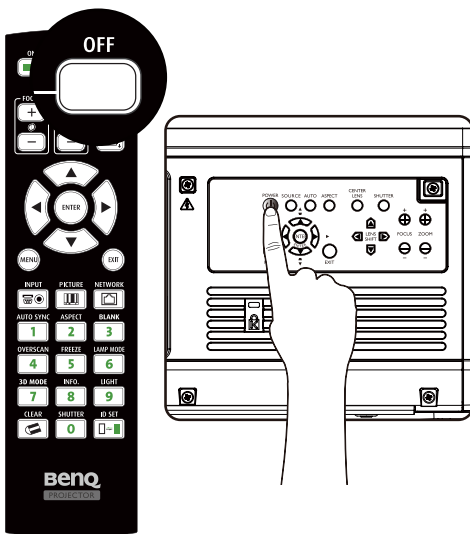

2. Press the **POWER** or **OFF** button again to verify power off, the cooling fans continue to operate (cooling-off time) and the power LED flashes orange. The cooling fans stop.

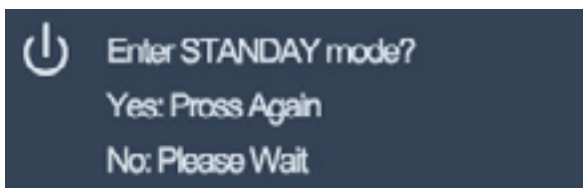

3. Press the Main Power switch to the off position (O) to turn off the projector.

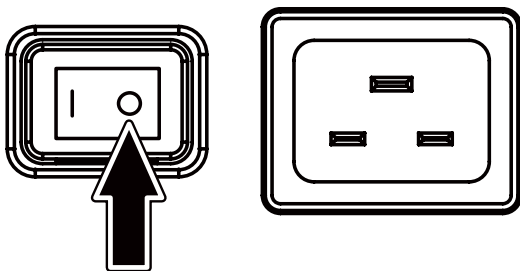

Using On-Screen Display

Using the Menu

The projector has an On-Screen Display (OSD) that lets you make image adjustments and change various settings.

Navigating the OSD

You can use the remote control or the buttons on the top of the projector to navigate and make changes to the OSD. The following illustration shows the corresponding buttons.

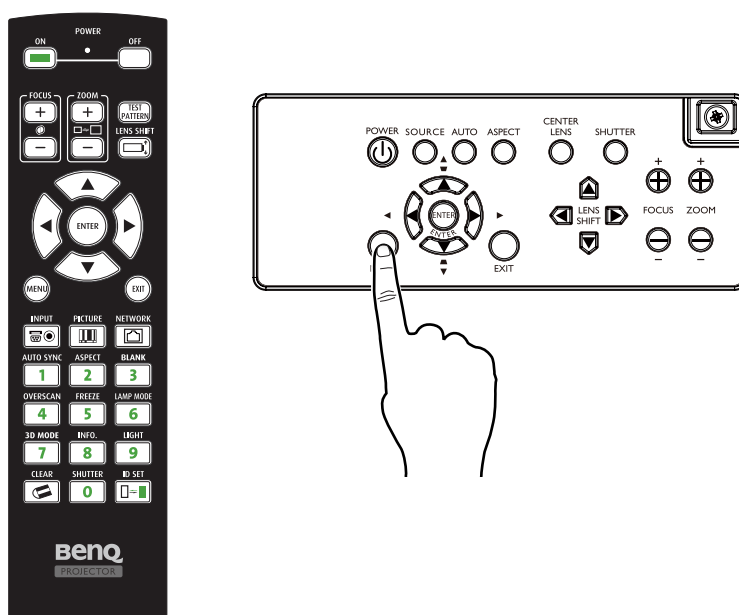

1. To open the OSD, press the **Menu** button on the OSD control panel or remote control. There are six folders on the menu. Press the cursor ◀ or ▶ buttons to move through secondary menus.
2. Press ▲ or ▼ to select menu items and ◀ or ▶ to change values for settings. Press up or down, Enter to confirm the new setting.



3. Press **RETURN** or **MENU** to leave a submenu or **MENU** to close menu.

On-Screen Display (OSD) menus

Use the following illustrations to quickly find a setting or determine the range for a setting. Please note that the on-screen display (OSD) menus vary according to the signal type selected.

Main menu	Sub-menu		
DISPLAY	Source	HDMI	
		DVI-D	
		Computer-1	
		Computer-2	
		DisplayPort	
		HD Connect	
	Test Pattern	Color Bar/Crosshatch/Burst/Red/Green/Blue/White/Black/H RampUncorrected Red/Uncorrected Green/Uncorrected Blue/Uncorrected White/Uncorrected Black/Off	
		Color Space	Auto
	YCbCr		
	YPbPr		
RGB-PC			
Input Lock	RGB-Video		
	Auto		
	48Hz		
	50Hz		
Background	Blue		
	Logo		
	Blue		
	Black		
Auto Sync Adjust	White		
	Off		
	Auto		
PICTURE	Picture Mode	Always	
		Dynamic	
		Presentation	
	Contrast	Cinema	
		Brightness	
		Saturation	
		Hue	
		Gamma	
	Color	Film	
		Graphics	
Video			
Linear			
2.2			
Color Temp		Native	
		5400K	
	6500K		
Trim	9300K		
	Red Lift		
	Green Lift		
		Blue Lift	

Main menu	Sub-menu	
PICTURE	Trim	Red Gain
		Green Gain
	Hue	Blue Gain
		Red
	Saturation	Green
		Blue
		Cyan
		Magenta
		Yellow
		Red
	Gain	Green
		Blue
		Cyan
		Magenta
		Yellow
		Red
	White Balance	Green
Blue		
Sharpness		
Noise Reduction		
Aspect Ratio	5:4	
	4:3	
	16:10	
	16:9	
	1.88:1	
	2.35	
	LetterBox	
	Auto	
	Real	
	Off	
Overscan	Crop	
	Zoom	
VGA Setup	H Total	
	H Start	
	H Phase	
	V Start	
Auto Sync		
LAMP	Mode	Dual Lamp
		Lamp 1
		Lamp 2
		Single

Main menu	Sub-menu		
LAMP	Power	Normal	
		Eco	
	High Altitude	Custom Power Level	
		On	
Lamp 1 Status	Off		
Lamp 2 Status			
ALIGNMENT	Projector Installation	Front Table	
		Rear Table	
		Front Ceiling	
		Rear Ceiling	
		Up + Front	
		Down + Front	
	Lens Control	Zoom	
		Focus	
		Shift V	
	Lens Memory	Shift H	
		Load Memory	Memory Set 1 to 10
	Center Lens Digital Alignment	Edit Memory	Memory Set 1 to 10
		Execute	
		Digital Zoom	
Digital Pan			
H/V Alignment	Digital Scan		
	Reset		
	H Zoom		
	V Zoom		
	H Shift		
	V Shift		
Reset			
CONTROL	Standby Mode	Standard	
		Eco	
		Network	
	Auto Power Off	On	
		Off	
	Direct Power On	On	
		Off	
	Network	IP Address	
		Subnet	
		Gateway	
DHCP		On Off	
RS232	Apply		
	Baud Rate	115200/57600/38400/19200/ 14400/9600/4800/2400/1200	

Main menu	Sub-menu		
CONTROL	RS232	Channel	Local HD Connect
	Startup Logo	On Off	
	Trigger	5:4 4:3 16:10 16:09 1.88 2.35 Letter Box Native	
	Auto Search	On Off	
	Dynamic Black	On Off	
	3D	3D Format	Off Auto Side by Side Top/Bottom Frame Sequential
		DLP Link	On Off
		3D Swap	Normal Reverse
		3D 24Hz Display	96Hz 144Hz
		Language	English, Deutsch, Español, Français, Italiano, Svenska, Português, Русский, 繁體中文, 简体中文, 한국어, 日本語
SERVICE	Model		
	Serial Number		
	Software Version		
	Active Source		
	Pixel Clock		
	Signal Format		
	H/V Refresh Rate		
	Lamp 1 Time		
	Lamp 2 Time		
	Blue Only	On Off	
	Factory Reset	OK Cancel	

OSD menu - DISPLAY

DISPLAY	PICTURE	LAMPS	ALIGNMENT	CONTROL	SERVICE
Source		Enter			
Test Pattern		Enter			
Color Space		< AUTO >			
Input Lock		< AUTO >			
Background		< LOGO >			
Auto Sync Adjust		< Always >			

- **Source**

This functions is the same as the Hotkey on your remote controller. You can select the desired input source with the remote controller or this function.

HDMI

This is the terminal to input HDMI signals from PC or media device.

DVI-D

his is the terminal to input DVI-D signals from PC.

Computer-1

This is the terminal to input RGB signals from PC.

Computer-2

This is the terminal to input YCbCr/YPbPr or RGB singals(RGBHV) from PC or media device.

DisplayPort

This is the terminal to input DisplayPort signal from PC or media device.

HD Connect

This is the terminal to input uncompressed high-definition video (HD) via RJ-45 cable.

- **Test Pattern**

The projector features a set of test patterns for installation and adjustment. Select the test pattern function in OSD or press the TEST PATTERN button on your remote controller to display the first test pattern, press again to display the next one. Repeat to scroll through available test pattern or press the Exit button to exit.

- **Color Space**

This function enables you to change color space of input signal. In most cases, you can select Auto to adopt the color space automatically set by the projector. You can select one the following options to use specific color space instead:

Auto: The projector switches to valid color space by detecting input signal.

YCbCr: Set color space to ITU-R BT.601.

YCbCr: Set color space to ITU-R BT.709.

RGB-PC: Set color space to RGB with black set to 0,0,0 and white to 255, 255, 255 (for 8-bit image).

RGB-Video: Set color space to RGB with black set to 16, 16, 16 and white to 235, 235, 235 (for 8-bit image) to comply with brilliance value defined in digital component standard.

- **Input Lock**

This function locks up one input source to the internal sync signal (Auto, 48Hz, 50Hz, or 60Hz). The Auto option would lock up the sync signal to the current signal source.

- **Background**

This function can be used to select pictures or color to be displayed on the blank screen. You can select background color to blue, black or white.

- **Auto Sync Adjust**

Set up auto sync options as below.

Auto: The projector remembers the last 10 signal sources. This Auto option enables the projector to select the last signal source.

Always: Execute auto sync function every time.

OSD menu - PICTURE

DISPLAY	PICTURE	LAMPS	ALIGNMENT	CONTROL	SERVICE
Picture Mode	<	Dynamic	>		
Contrast	<	100	>		
Brightness	<	100	>		
Saturation	<	100	>		
Hue	<	100	>		
Gamma	<	Video	>		
Color		Enter			
Sharpness	<	0	>		
Noise Reduction	<	0	>		
Aspect Ratio	<	16:10	>		
Overscan	<	Off	>		
VGA Setup		Enter			
Auto Sync		Execute			

- **Picture Mode**

Press ◀▶ arrow key to select display mode.

Dynamic: Output in the highest brightness for application that requires higher brightness

Presentation: Display the best image effect for presentation or static image projection.

Cinema: Display in best color effect for film playback.

- **Contrast**

Press ◀▶ arrow key to adjust image contrast.



Caution:

Brightness and contrast are two mutually dependent factors. To achieve optimized settings you may have to fine tune brightness settings after contrast adjustment.

- **Brightness**

Press ◀▶ arrow key to adjust image brightness.

- **Saturation**

Press ◀▶ arrow key to adjust saturation level. (The higher the level the more saturated the color.)

- **Hue**

Press ◀▶ arrow key to adjust hue level of color.

- **Gamma**

Details of darker areas in an image may look worse when ambient light is very bright. You may use the following gamma correction options to adjust color difference of image.

Film: Adjust color difference correction to approximate Gamma 2.2.

Graphics: Apply to situation where brightness at the expense of gray scale precision is required by computer demonstration document.

Video: Similar to film color difference correction but differs in the darker colored areas of an image. This addresses the image creation function employed by cameras.

Linear: Linear color difference correction.

2.2: Set color difference correction to 2.2.

- **Color**

Press ◀▶ arrow key to adjust color temperature of image.

- **Sharpness**

Press ◀▶ arrow key to adjust values of high frequency details.

- **Noise Reduction**

Press ◀▶ arrow key to adjust noise of projection image. This function helps eliminating image noise caused by interlaced scanning input. In general, image noise reduction decreases value of high frequency details and makes the image looking smoother.

- **Aspect Ratio**

Use this option to adjust aspect ratio.

For normal input of 16:10 the aspect ratio will look like the following images:

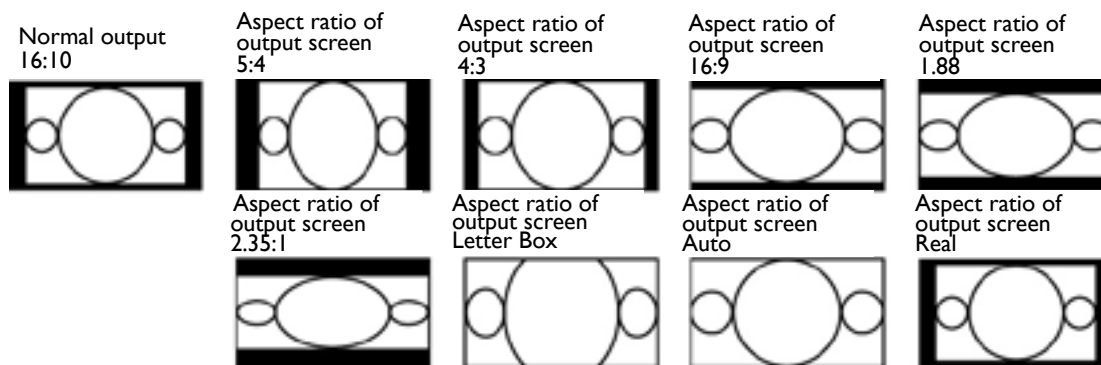

For normal input of ratio 4:3, the aspect ratio will look like the following images:

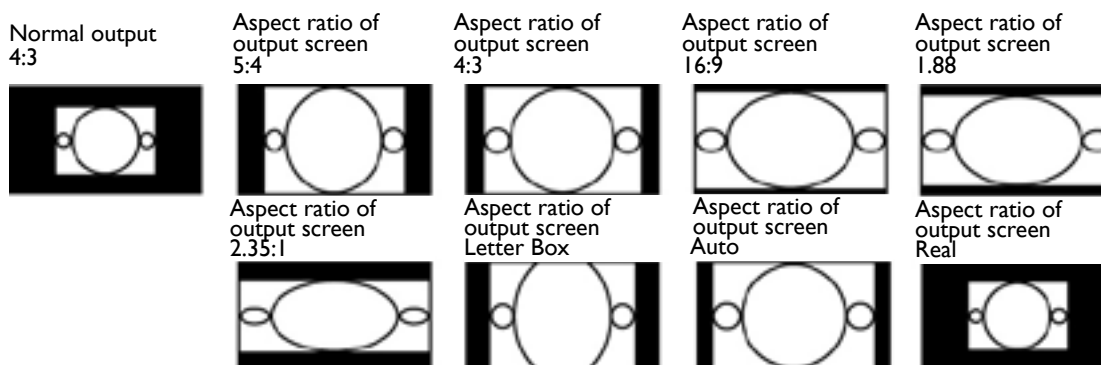

- **Overscan**

Input source may be not an image with 16:10 ratio and there may be noise at image margin. Select one of the three options to hide image margin:

- **VGA Setup**

Set up VGA signal display's H Total, H Start, H Phase and V Start.

- **Auto Sync**

Press Enter key to execute Auto Sync function.

OSD menu - LAMP

DISPLAY	PICTURE	LAMPS	ALIGNMENT	CONTROL	SERVICE
Mode		Enter			
Power		Eco			
High Altitude	<	Off	>		
Custom Power Level	<	—	>		
Lamp 1 Status		On			
Lamp 2 Status		On			

- **Mode**

Press ◀▶ arrow key to select single or dual lamp mode.

Dual: Enable the dual-lamp projection mode.

Lamp 1: Select lamp 1 only for projection. The projector switches to lamp 2 if lamp 1 is abnormal in activation.

Lamp 2: Select lamp 2 only for projection. The projector switches to lamp 1 if lamp 2 is abnormal in activation.

Single: This is a single lamp mode but the lamp is not specified. The projector selects the lamp that has the least operation hours automatically whenever it's turned on.



Caution:

- In lamp 1 or lamp 2 mode, the projector switches to another lamp when it encounters any abnormality. The green LED indicator of the replacing lamp flashes until the lamp lights up.
- Settings of single lamp mode apply only after the next projector powers on.
- Fast switching between lamp modes may shorten its life cycle. The lamp mode function will be disabled (dimmed) until the mode is changed successfully after every lamp mode switching.
- The lamp mode option remains disabled until the lamp mode is changed successfully.

- **Power**

Press ◀▶ arrow key to select ECO (power saving), Normal, or Custom Power Level.

Normal: To project at normal lamp power for the highest brightness output.

ECO: To project in economic mode for longer lamp life cycle.

Custom Power Level: You can set lamp power at 75-100% to normal mode for fine tuning image projection. This function helps for fast installation of multiple projectors and regular maintenance.

- **High Altitude**

You can use this function to turn the option to ON for switching the cooling setting if the project is installed in a high altitude environment, the default is OFF.

Normally, the projector can operate normally when this function is set to OFF. The projector detects ambient temperature by default to regulate the cooling fan speed.

When the temperature rises, the cooling fan speeds up (with higher noise) to exhaust

the internal heat energy out of the projector and ensure its normal operation. However, the projector may turn off automatically if it is used in an environment at excessively high temperature or in an area at a high altitude. In this case, you can enable this function by setting it to ON and have the cooling fan operate at a higher speed to control the internal temperature of the projector.

 **Note:**

An area is considered high altitude when it is above 5000 feet.

- **Custom Power Level**
Press ◀▶ arrow key to customize lamp output power in the range of 75-100% of normal mode. This function is valid only when the Custom Power Level option is set to Custom Power Level mode. In the other two modes, Normal and ECO, this function is disabled (dimmed).
- **Lamp 1 Status**
Indicates status of lamp 1 now, ON or OFF.
- **Lamp2 Status**
Indicates status of lamp 2 now, ON or OFF.

OSD menu - ALIGNMENT

DISPLAY	PICTURE	LAMPS	ALIGNMENT	CONTROL	SERVICE
Projector Installation	<	Front	>		
Lens Control		Enter			
Lens Memory		Enter			
Center Lens		Execute			
Keystone	<	0	>		
Digital Alignment		Enter			
H/V Alignment		Enter			

- **Projector Installation**
Press ◀▶ arrow key to select Projector Installation : Front Table, Rear Table, front Ceiling, rear Ceiling, Upward + front, and Downward + front.

 **Caution:**

The cooling fan speed varies with projection mode to ensure the projector's proper heat dissipation. Invalid projection can lead to the projector overheating or shortened lamp life. Be careful to choose the correct projection mode when installing your projector.

- **Lens Control**
Select this function or press the LENS Shift button on the remote controller to open the lens control menu to zoom, focus or shift the lens. Press Enter key to switch zoom/focus or lens shift

menu, press ◀▶ arrow key focus the projected image or shift the lens in horizontal direction, and ▲▼ to zoom the projection size or shift the lens in vertical direction.

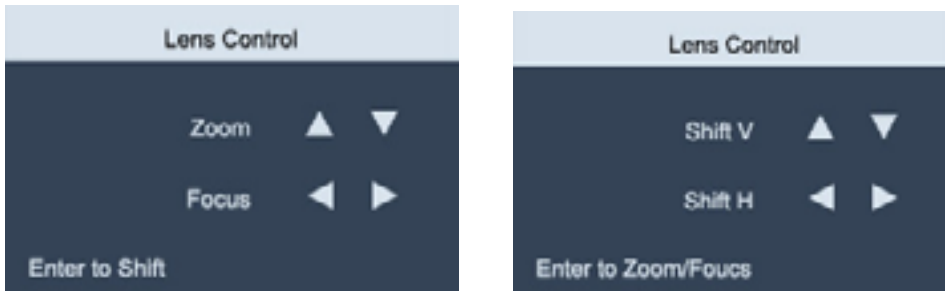

- **Lens Memory**

The projector can memorize up to 10 zoom, focus, and lens shift settings. You can give each group of settings a unique name with the virtual keyboard. You can save current lens position (horizontal and vertical), zoom and focus settings as well as retrieve and load saved lens memory for the projector to apply the newly loaded lens shift, zoom, and focus settings.

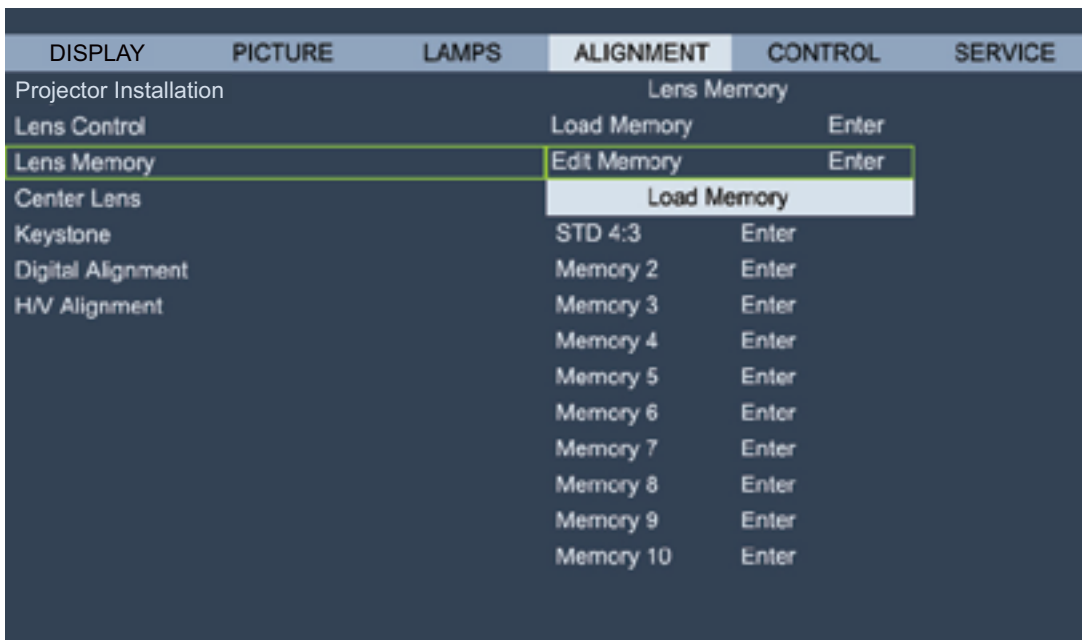

- **Load Memory:** To recall saved lens settings: Press Enter key to display lens memory list, press ▲▼ arrow key to select desired memory, press Enter key again to retrieve and load the saved lens settings. The projector can keep 10 groups of lens settings. The memory position with lens settings will be marked in a different color and you can select only those with actual settings. To add or change lens memory, please select below Edit Memory option.
- **Edit Memory:** Edit memory name and save current memory settings including lens shift, zoom and focus. Press Enter key to display the virtual keyboard. Press ▲▼◀▶ and Enter keys to select or accept setup values.



- **Change lens memory name:** Your lens memory has a default name in the format of "Memory_NN" where NN is any number from 00 to 99. You may press Backspace key to erase characters shown in dialog box, press Caps key to toggle switch between upper and lower case, ▲▼◀▶ key to select letters, and Enter key to accept changes made. Each memory name can contain up to 9 characters including letters, numbers, symbols and blank spaces.
- **Cancel:** Press to cancel changes made to lens settings.
- **Accept:** Press to accept changes made to lens settings.
- **Clear Memory:** Press to clear settings saved in current memory position. The memory button prompts you to confirm the deletion. Press Enter to delete the settings or ▲▼◀▶ key to move the cursor away from the position and cancel the deletion.

 **Caution:**

Please execute the Center Lens function every time a lens is installed to ensure that the projector memorizes the exact lens settings.

- **Center Lens**
This function calibrates the lens, for the lens memory and positions it to the predefined center.
- **Keystone**
Select this function and press ◀▶ arrow key to correct vertical deformation caused by projection angle.
- **Digital Alignment**

DISPLAY	PICTURE	LAMPS	ALIGNMENT	CONTROL	SERVICE
Projection Mode	<	Front	>	Digital Alignment	
Lens Control		Enter		Digital Zoom	< 0 >
Lens Memory		Enter		Digital Pan	< 0 >
Center Lens		Execute		Digital Scan	< 0 >
Keystone	<	0	>	Reset	Execute
Digital Alignment		Enter			
H/V Alignment		Enter			

Select this function to zoom the projection image.

Digital Zoom: Press ◀▶ arrow key to zoom in the projection image.

Digital Pan: Press ◀▶ arrow key to pan out on projection image. This is valid only when the projected image is enlarged.

Digital Scan: Press ◀▶ arrow key to tilt projection image. This is valid only when the projected image is enlarged.

Reset: Press to reset Digital Alignment settings to factory default values.

- **H/V Alignment**

H Zoom: Use ◀▶ to narrow the horizontal size of the projected image.

V Zoom: Use ◀▶ to narrow the vertical size of the projected image.

H Shift: Use ◀▶ to move the narrowed projected image horizontally. This function is only available when the projected image is narrowed.

V Shift: Use ◀▶ to move the narrowed projected image vertically. This function is only available when the projected image is narrowed.

Rest: Set the H/V Alignment back to the factory default settings.

OSD menu - CONTROL

DISPLAY	PICTURE	LAMPS	ALIGNMENT	CONTROL	SERVICE
Standby Mode		< Standard >			
Auto Power off		< Off >			
Direct Power On		< Off >			
Network		Enter			
RS232		Enter			
Startup Logo		< Off >			
Trigger		< Off >			
Auto Search		< Off >			
Dynamic Black		< Off >			
3D		Enter			
Language		Enter			

- **Standby Power**

Press ◀▶ arrow key to toggle switch between Standard, ECO and Network mode.

Standard: The projector can be turned on using the remote control, RS-232 command or network control.

Eco: The projector maintains in the standby status at the lowest power (<0.5W). In this mode, the projector can be turned on only using the power button on the remote controller or projector.

Network: The projector maintains in the standby status at the power consumption under 6W, the projector can be turned on using the power button or network control only, RS-232 control command and wired remote control signal via external transmitter through RJ45 cable are not available.

 **Note:**

Some of communication port are turned off if it's set to ECO or Network mode, please make sure that the standby mode is set to proper setting.

- **Auto Power off**

The default setting is Off. The projector powers off automatically after 20 minutes without input signal when set to On.

- **Direct Power on**

The default setting is Off. The projector powers on automatically once it is connected to any AC power supply if set to On.

- **Network**

You can use the network function to configure a network for projector control.

DISPLAY	PICTURE	LAMPS	ALIGNMENT	CONTROL	SERVICE
Standby Mode	<	Standard	>	Network	
Auto Power off	<	Off	>	IP Address	< XXX.XXX.XXX.XXX >
Direct Power On	<	Off	>	Subnet	< 255.255.255.0 >
Network		Enter		Gateway	< XXX.XXX.XXX.XXX >
RS232		Enter		DHCP	Off
Startup Logo	<	Off	>	Apply	Enter
Trigger	<	Off	>		
Auto Search	<	Off	>		
Dynamic Black	<	Off	>		
3D		Enter			
Language		Enter			

Press ▲▼ arrow and Enter key to select network and its settings:

IP Address: To specify an IP address, press the Enter button to show the IP address input window. Use the ◀▶ button to select the number in the address to be changed. Use the ▲▼ button to increase or decrease the number in the IP address.

Network	
IP Address	172.xxx.xxx.xxx

Subnet: Set up IP address of subnet.

Gateway: Set up IP address of gateway.

DHCP: Set DHCP to On or Off. If this is set to On, the DHCP server of the network domain assigns an IP address to the projector. That is, the IP address is displayed in the address window instead of being entering manually. Otherwise, the domain does not or cannot assign an IP address, and 0.0.0.0 is shown on the IP address window.

Apply: Select this button and press Enter. It takes several seconds to execute the change in network settings till the following message disappears.

Setting network configuration, please wait

For further information on network control connections and settings, please refer to the Remote control manual.

• RS232

Baud Rate: Set transmission speed to: 115200, 57600, 38400, 19200, 14400, 9600, 4800, 2400 and 1200. Transmission speed shall vary with length of RS-232 cable (longer cable requires slower speed). In case of unstable signal or connection failure when controlling with RS-232 cable, try downgrading the transmission speed.

Channel: You can send RS-232 control commands to your projector through the RS-232 port or external digital transmission box connected to its HD Connect/Lan port. Please set up the following communication channel before sending control commands::

Local: Send RS-232 control command through your projector's RS-232 port. Please set up proper transmission speed in advance.

HD Connect: Send RS-232 control commands to your projector's HD Connect/Lanport through an external digital transmission box. The transmission speed is automatically set to 9600.



Caution:

- If the projector is set to standby at ECO mode, the LAN and RS-232 remote control function is disabled. You can power on the projector only with the remote controller or its power switch.
- Please change the standby mode of the projector to Standard before using the remote control function.

- **Startup Logo**

Press ◀▶ arrow key to enable /disable the startup logo function.

- **Trigger**

The projector features one trigger output. If the projector comes with an auto screen device, you can connect it to the trigger to open the screen when the projector powers up. This function may have a 2-3 second lag before powering up.

- **Auto Search**

Press ◀▶ arrow key to enable/disable the Auto Search.

- **Dynamic Black**

Press ◀▶ arrow key to enable/disable dynamic black mode.

- **3D**

Set up 3D format and sync method. The projector displays options available for setup and dims those unselectable by detecting connected input signal type. Please ensure you have connected to input signal before 3D setup. DO NOT undertake 3D setup without connecting to an input source.

DISPLAY	PICTURE	LAMPS	ALIGNMENT	CONTROL	SERVICE
Standby Mode	<	Standard	>	3D	
Auto Power off	<	Off	>	3D Format	Enter
Direct Power On	<	Off	>	DLP Link	< On >
Network		Enter		3D Swap	< Normal >
RS232		Enter		3D 24Hz Display	< 96Hz >
Startup Logo	<	Off	>	3D Format	
Trigger	<	Off	>	Off	Execute
Auto Search	<	Off	>	Auto	Execute
Dynamic Black	<	Off	>	Side by Side	Execute
3D		Enter		Top / Bottom	Execute
Language		Enter		Frame Sequential	Execute

3D Format: Point to this option and press Enter key to enable 3D playback and set up 3D options.

Off: Disable 3D display mode. 3D mode is enabled once Auto, Side by Side, Top/Bottom or Frame Sequential mode is selected. To disable 3D mode, select Off then press Enter.

Auto: Enable 3D format once Frame Packing, Side by Side, Top / Bottom, or Frame packing input format is detected. This function applies to the following input signal only:

- HDMI 1.4a 3D input signal
- HDMI 1.4a 3D signal sent to the projector through digital transmitter

Side by Side: Set 3D format to Side by Side manually. This option applies to HDMI input signal or HDMI signal through a digital transmitter.

Top / Bottom: Set 3D format to Side by Side manually. This option applies to HDMI, DVI, or DisplayPort input signals or these signals through digital transmitter.

Frame Sequential: Set input format to Frame Sequential.

DLP Link: Select to disable or enable DLP Link sync.

3D Swap: Set 3D Swap to Inverse if left and right eye 3D image inversion by 3D glasses is needed. If image looks normal, keeps current settings, Normal, intact.

3D 24Hz projection: Set frame rate to 144fps or 96fps when input signal is at 24Hz.

Caution:

The projector supports DLP Link and 3D IR sync. After 3D mode is enabled, you can sync the signal of 3D glasses with both built-in DLP Link and external 3D IR transmitter or close the former and rely on the latter for 3D signal sync.

Please remember:

- *People with the following conditions should view 3D images with great care:*
 - *Children under six years old*
 - *Those with light sensitization disease, ah istory of heart disease and poor health*
 - *Those experiencing physical fatigue or a lack of sleep*
 - *Those under the influence of drugs or alcohol*
- *Under normal conditions it is safe to view 3D images. Some might feel discomfort. Please refer to the guidelines made public by the 3D alliance on 2008-12-10. Please take at least 5-15 minutes rest for every 30-60 minutes viewing.*
- **Language**
Select desired language displayed in your OSD menu: English, French, Spanish, Dutch, Portuguese, Simplified Chinese, Traditional Chinese, Japanese, or Korean.

OSD menu - SERVICE

DISPLAY	PICTURE	LAMPS	ALIGNMENT	CONTROL	SERVICE
Model :	PU9730				
Serial Number :	XXXXXXXX				
Software Verision :	MPxx-0Dxx-PUxx-RDxx-SExx-PDxx-xxxx				
Active Source	VGA				
Pixel Clock	64.97 MHZ				
Signal Format	1024x768 @60Hz				
H/V Refresh Rate :	H: 49.578 KHZ V: 60HZ				
Lamp 1 Time	168 HRS				
Lamp 2 Time	168 HRS				
Power On Time	168hrs				
Blue Only	<	Off	>>		
Factory	Execute				

Display basic information on the projector.

- **Model**
Projector model number
- **Serial Number**
Projector serial number
- **Software Version**
Version of software installed in the projector.
- **Active Source**
Display signal source being used.

- **Pixel Clock**
Display pixel clocking of current input signal.
- **Signal Format**
Display signal format of current input signal.
- **H/V Refresh Rate**
Display horizontal and vertical refresh rate of current image.
- **Lamp 1 Time**
Show use hours of lamp 1. After replacing a new lamp the hour counter resets to zero.
- **Lamp 2 Time**
Show use hours of lamp 2. After replacing a new lamp the hour counter resets to zero.
- **Power On Time**
Display operation hours of the projector.
- **Blue Only**
The projector displays a blue color screen with this option to help maintenance personnel inspect images. For further information on using functions, please consult with qualified maintenance personnel.
- **Factory Reset**
Select this option to reset menu settings back to factory default including every user defined setup value.

**Caution:**

Lamp use hours remain intact when reset settings to factory default.

Additional information

Cleaning the lens

Clean the lens whenever you notice dirt or dust on the surface. Before you attempt to clean the lens, turn the projector off, unplug the power cable, and leave it several minutes to cool completely. Use a canister of compressed air to remove dust. (Available from building hardware or photographic suppliers.)

If there is stubborn dirt or smudge marks, use a proper photographic lens brush or moisten a cleansoft lens cloth with lens cleaner to gently wipe the lens surface.

Never use any type of abrasive pad, alkaline/acid cleaner, scouring powder, or volatile solvent, such as alcohol, benzene, thinner or insecticide. Using such materials or maintaining prolonged contact with rubber or vinyl materials may result in damage to the projector surface and cabinet material.

Note:

Never touch the lens with your finger or rub the lens with abrasive materials. Even paper towels can damage the lens coating. Only ever use a proper photographic lens brush, cloth, and cleaning solution.

Do not attempt to clean the lens while the projector is switched on or is still hot from previous use. Be sure to turn off the projector and let it cool down completely before cleaning the lens.

Care of the projector

Your projector needs little maintenance. The only thing you have to do on a regular basis is keep the lens clean. Never remove any parts of the projector except the lamp. Contact your dealer or local customer service center if the projector fails to operate as expected.

Cleaning the projector case

Before you attempt to clean the case, turn the projector off, unplug the power cable, and leave it several minutes to cool completely.

To remove dirt or dust, wipe the case with a soft, dry, lint-free cloth.

To remove stubborn dirt or stains, moisten a soft cloth with water and a neutral detergent. Then wipe the case.



Never use wax, alcohol, benzene, thinner or other chemical detergents. These can damage the case.

Storing the projector

If you need to store the projector for an extended time, please:

Make sure the temperature and humidity of the storage area are within the recommended range for the projector. Please refer to the Spec. page in this manual or consult your dealer about the range.

Retract the adjuster feet.

Remove the batteries from the remote control.

Pack the projector in its original packing or equivalent.

Transporting the projector

It is recommended that you ship the projector with its original packing or equivalent.

Replacing the lamp

The projection lamps should be replaced when they burn out. They should only be replaced with a certified replacement part, contact your local dealer if unsure.



- **Lamps are positioned differently. Take care not to force the lamps when replacing.**
- **Installation of both lamp modules (Lamp 1 and Lamp 2) is required to operate the projector in dual or single lamp mode. If only a single lamp module is installed, the projector's lamp will not turn on and will appear as a lamp failure.**



- **The lamp contains a certain amount of mercury and should be disposed of according to local ordinance regulations.**
- **Avoid touching the glass surface of the new lamp: doing so may shorten its operation life.**



Lamp Handling Precautions

- This projector uses a high-pressure lamp which must be handled carefully and properly. Improper handling may result in accidents, injury, or create a fire hazard.
- Lamp life may differ from lamp to lamp and according to the environment of use. There is no guarantee of the same life for each lamp. Some lamps may fail or terminate their life in a shorter period of time than other similar lamps.
- If the projector indicates that the lamp should be replaced, i.e., if LAMP 1 and/or LAMP 2 light up, replace the lamp with a new one IMMEDIATELY after the projector has cooled down. (Follow carefully the instructions in the Lamp Replacement section of this manual.) Continuous use of the lamp with LAMP 1 and/or LAMP 2 lighted may increase the risk of lamp explosion.
- A Lamp may explode as a result of vibration, shock or degradation as a result of hours of use as its lifetime draws to an end. Risk of explosion may differ according to the environment or conditions in which the projector and lamp are being used.

If a lamp explodes, the following safety precautions should be taken:

- Disconnect the projector's AC plug from the AC outlet immediately. Contact an authorized service station for a checkup of the unit and replacement of the lamp. Additionally, check carefully to ensure that there are no broken shards or pieces of glass around the projector or coming out from the cooling air circulation holes. Any broken shards found should be cleaned up carefully. No one should check the inside of the projector except those who are authorized trained technicians and who are familiar with projector service. Inappropriate attempts to service the unit by anyone, especially those who are not appropriately trained to do so, may result in an accident or injury caused by pieces of broken glass.
- The projection lamp should be replaced when it burns out. It should only be replaced with a certified replacement part, which you can order from your local dealer.



- Be sure to turn off and unplug the projector at least 30 minutes before replacing the lamp. Failure to do so could result in a severe burn.
- Safety glasses should be worn when replacing the lamp while the projector is ceiling mounted.

1. Power off and unplug the projector power cord. Remove the lamp module to be replaced after it cools down and the temperature of its lamps and peripheral components falls.

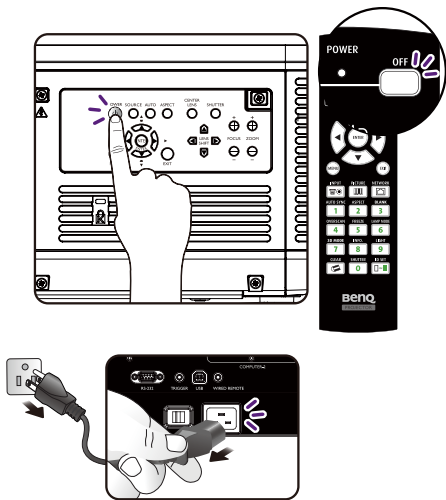

2. Loosen the screws holding the lamp cap with a screwdriver before removing it.

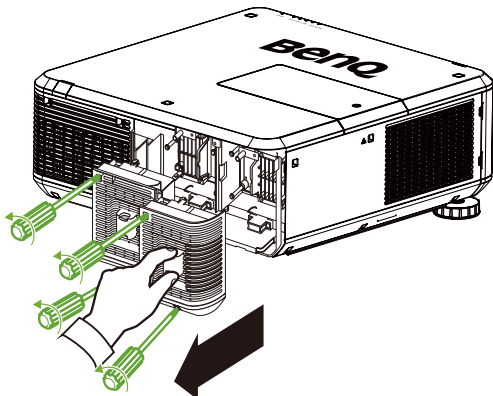

3. Loosen the screws holding the lamp with a screwdriver before removing it.

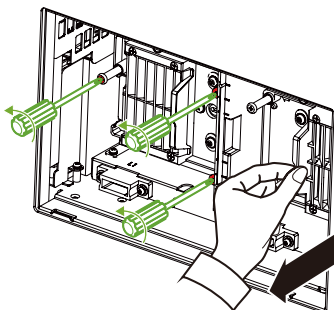

4. Insert a new lamp according to orientation of the old one.

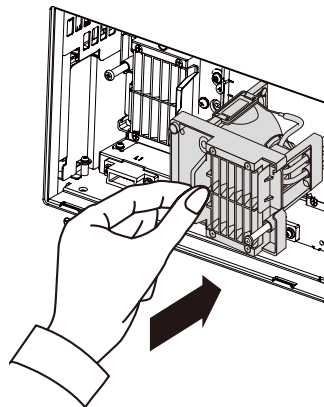

5. Cover the lamp cap by tightening the lamp screws with a screwdriver.

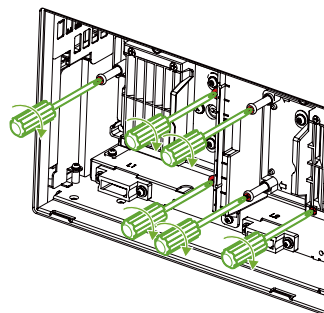

6. Cover the lamp cap and tighten

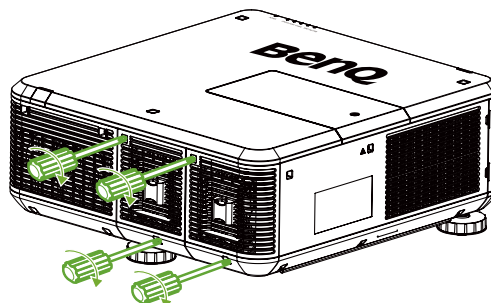

- Pulling it too quickly may cause the lamp to break and scatter broken glass in the projector. To reduce the risk of injuries to fingers and damage to internal components, use caution when removing lamp glass that has shattered.
- Do not place the lamp in locations where water might splash on it, children can reach it, near or above heat sources, or near flammable materials.
- Do not insert your hand into the projector when the lamp is removed. If you touch the optical components inside, it could cause blurred images.
- Please be careful to not over-tighten the screws. Loose screws may cause a bad connection, which could result in malfunction.

Installing the optional color wheel

The projector comes with a bright-type color wheel installed, an additional color-type color wheel is optional. To replace the color wheel (located under the lamp cover adjacent to lamp 1) refer to the following guide.

1. Turn the power off and disconnect the projector from the power outlet. Turn off all connected equipment and disconnect all other cables.

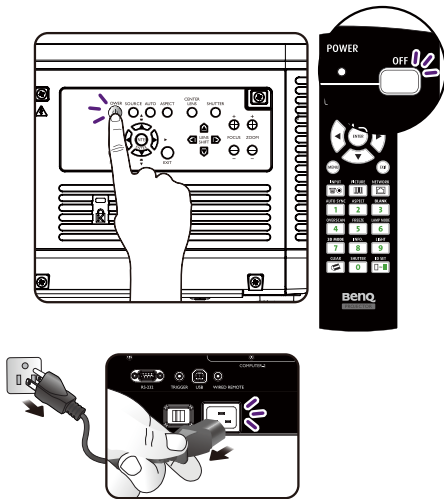

2. Remove the screws on the lamp cover and slide the lamp cover as shown.

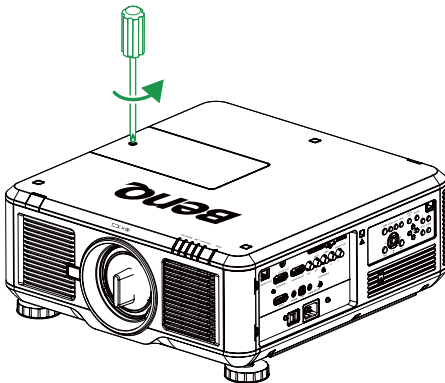

3. Unscrew the retaining screws (x 4) on the color wheel.

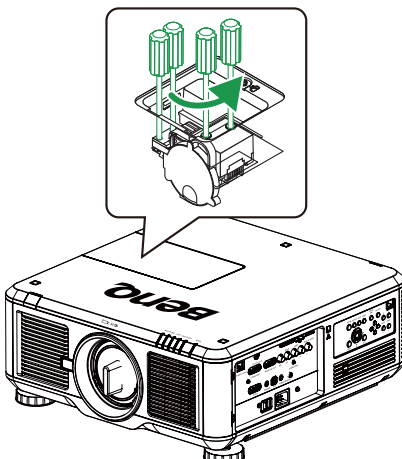

4. Lift the color wheel in the direction shown.

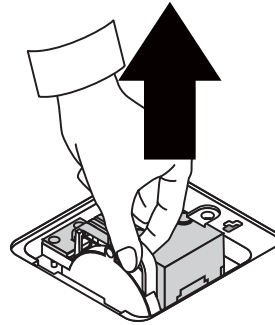

5. Insert the new color wheel.

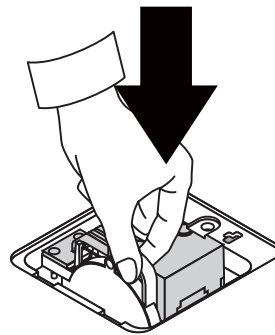

6. Secure the retaining screws as shown, and then close the lamp cover.

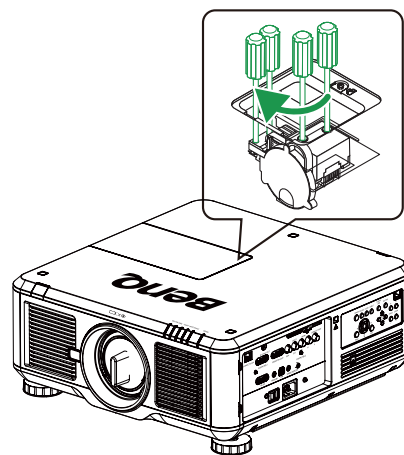

Storing Unused Color Wheel: Keep the unused color wheel in the zipper bag in which the 6-segment color wheel (not supplied) was packaged. This bag prevents dust from falling or collecting on the color wheel.

Replacing the filter

Dirtiness and replacement time for filters varies with the environment. Please check the filter regularly to get the best projector performance.

Caution:

A dirty filter impedes volume of air flowing into the projector which, in turn, leads to system protection enabling or component damage caused by overheating. Please check, remove dust or replace the filter.

1. Open up the left or right front filter cap.

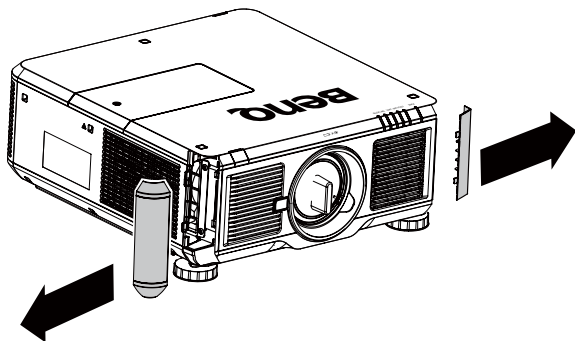

3. Insert a new filter.

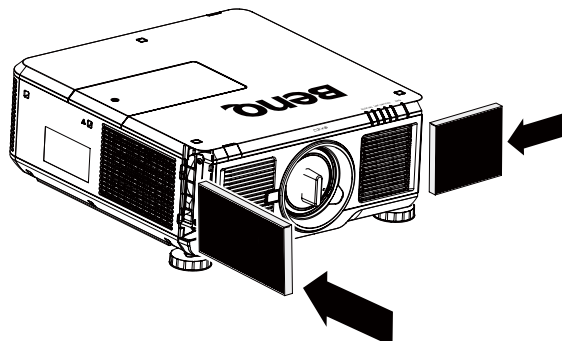

2. Remove the used filter.

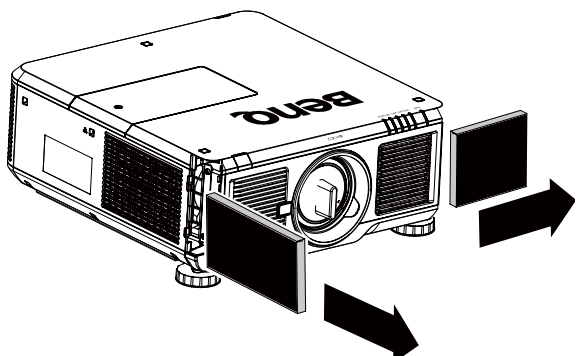

4. Cap the front cover and it's done.

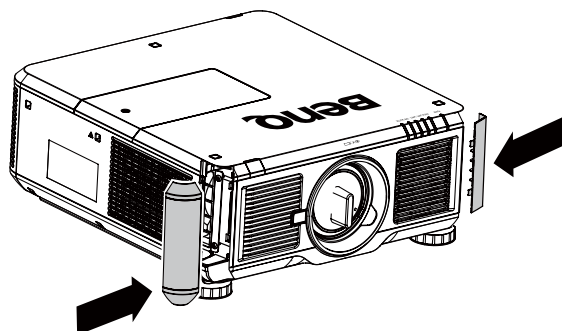

Specifications

Model		PU9730	PW9620	PX9710
Display Device		0.67", I-DLP Chip	0.65", I-DLP Chip	0.7", I-DLP Chip
Resolution		WUXGA	WXGA	XGA
Input Terminals	HDMI (Compatible with HDCP)			
	DVI-D (Compatible with HDCP)			
	Display Port (Compatible with HDCP)			
	Computer-2 (5BNC)			
	Computer-1 (D-sub 15p)			
Output Terminals	Monitor Out (D-sub 15 p)			
	Trigger (ϕ 3.5mm stereo min jack)	X1(DC 12V Output)		
	3D IR Sync (VESA mini din)			
Control and Service	Lan (RJ-45)			
	Wired Remote (ϕ 3.5mm stereo min jack)			
	RS-232C			
	USB (Type B) for service			
Power Requirement		AC 110 - 240V, 50/60Hz		
Input Current		7.3A		
Power Consumption (Standard, Dual lamp Mode)		845W (23.05W/<0.5W) with AC 110V 815W (21.5W/<0.5W) with AC 240V		
Operation Temperature		41°C to 104°C (5°C to 40°C)		
Storage Temperature		14°C to 140°C (-10°C to 60°C), 5% to 90% Humidity (non-condensing)		
Dimensions		20.5" (W) x 7.7" (H) x 20.9" (D) 520 mm (W) x 195m (H) x 532 mm (D) (not including protrusions or feet)		
Weight		20.5kg		

Dimension

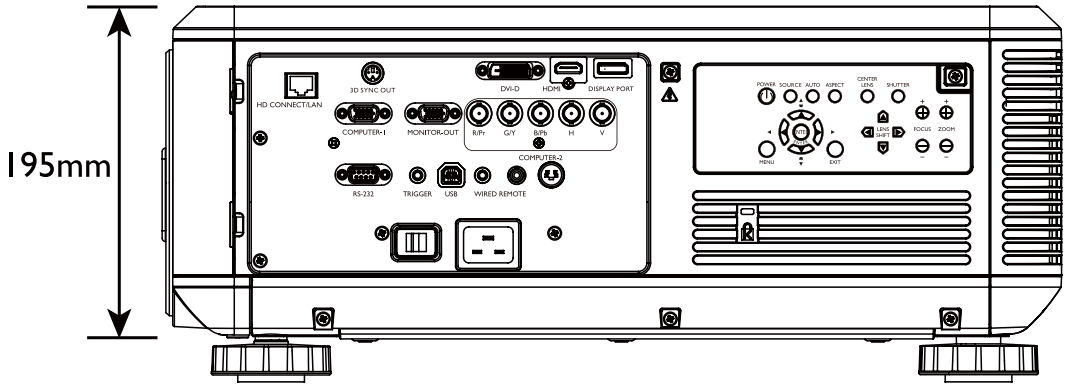
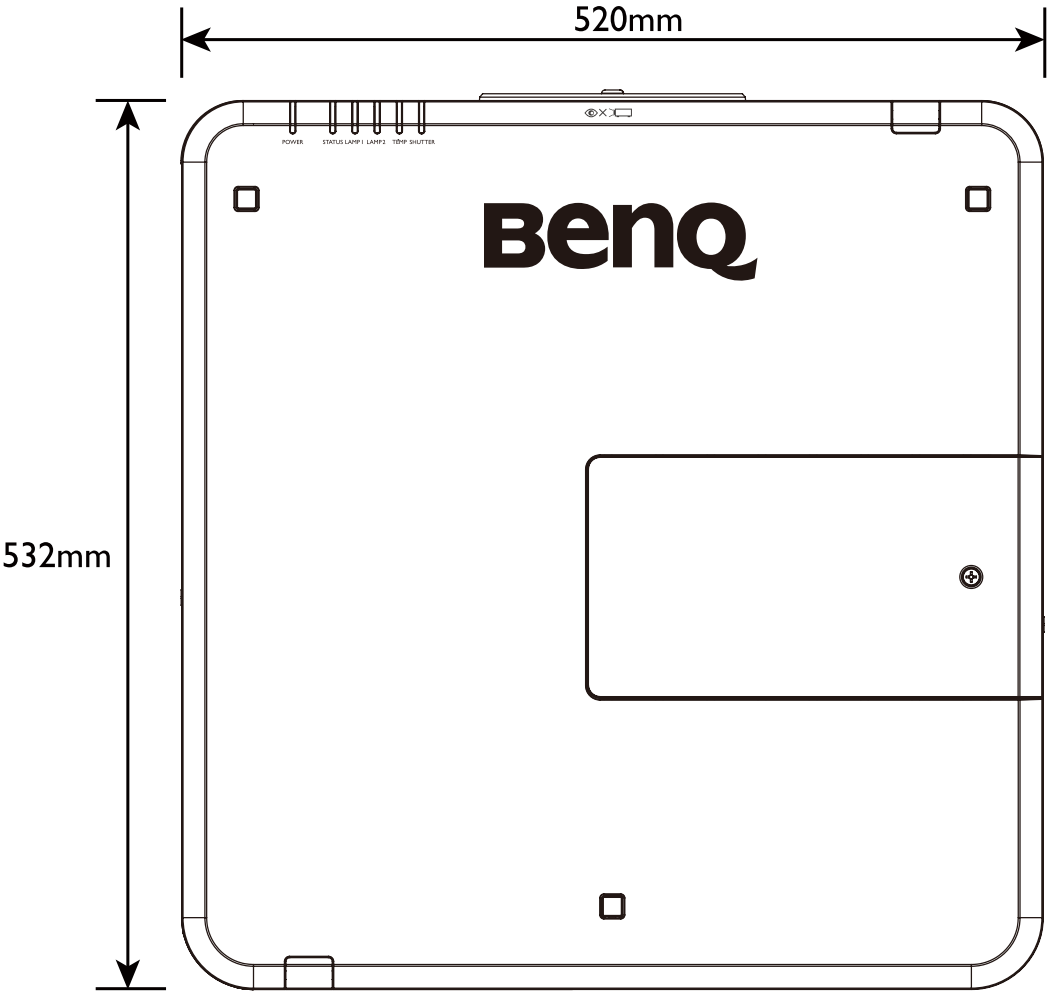

Timing chart

The following table shows compatible signal types, their resolution and frequency refresh rates.
Horizontal: 15kHz, 31kHz to 90 kHz, Vertical: 50 Hz to 85 Hz

PC timing

Signal Type	Resolution	Frame Rate	Component BNC		VGA		DVI-D	HDMI/HD Connect		DisplayPort
			RGBHV	YUV	RGBHV	YUV		RGB	YUV	
PC	640x480	59.94	V		V		V	V		V
	640x480	75	V		V		V	V		V
	640x480	85	V		V		V	V		V
	800x600	75	V		V		V	V		V
	800x600	85.06	V		V		V	V		V
	848x480	47.95	V		V		V	V		V
	848x480	59.94	V		V		V	V		V
	1024x768	60	V		V		V	V		V
	1024x768	75.03	V		V		V	V		V
	1024x768	85.03	V		V		V	V		V
	1280x720	47.95	V		V		V	V		V
	1280x768	59.87	V		V		V	V		V
	1280x800	59.81	V		V		V	V		V
	1280x960	60	V		V		V	V		V
	1280x1024	60.02	V		V		V	V		V
	1280x1024	75.02	V		V		V	V		V
	1280x1024	85.02	V		V		V	V		V
	1366x768	59.79	V		V		V	V		V
	1440x900	59.887	V		V		V	V		V
	1600x1200	60	V		V		V	V		V
1920x1080	47.95	V		V		V	V		V	
1680x1050	59.94	V		V		V	V		V	
1920x1200 (Reduce Blanking)	60	V		V		V	V		V	
1400x1050	60	V		V		V	V		V	
Apple Mac	640x480	66.59	V		V		V	V		V
	832x624	74.54	V		V		V	V		V
	1152x870	75								V
SDTV	1440x480i	60						V	V	V
	1440x576i	50						V	V	V

Signal Type	Resolution	Frame Rate	Component BNC		VGA		DVI-D	HDMI/HD Connect		DisplayPort
			RGBHV	YUV	RGBHV	YUV		RGB	YUV	
EDTV	480p	59.94	V	V	V	V	V	V	V	V
	576p	50	V	V	V	V	V	V	V	V
	1080i	50	V	V	V	V	V	V	V	V
	1080i	59.94	V	V	V	V	V	V	V	V
	1080i	60	V	V	V	V	V	V	V	V
	720p	50	V	V	V	V	V	V	V	V
	720p	59.94	V	V	V	V	V	V	V	V
	720p	60	V	V	V	V	V	V	V	V
	1080p	23.98	V	V	V	V	V	V	V	V
	1080p	24	V	V	V	V	V	V	V	V
	1080p	25	V	V	V	V	V	V	V	V
	1080p	29.97	V	V	V	V	V	V	V	V
	1080p	30	V	V	V	V	V	V	V	V
	1080p	50	V	V	V	V	V	V	V	V
	1080p	59.94	V	V	V	V	V	V	V	V
	1080p	60	V	V	V	V	V	V	V	V

3D supported timing

Signal Type	Resolution	Frame Rate	Frame Packing	Side by Side	Top / Bottom	Fram Sequential
PC	640x480	59.94				V
	848x480	47.95				V
	848x480	59.94				V
	1024x768	60				V
	1280x720	47.95				V
	1280x768	59.87				V
	1280x800	59.81				V
	1280x960	60				V
	1280x1024	60.02				V
	1366x768	59.79				V
	1440x900	59.887				V
	1600x1200	60				V
	1920x1080	47.95				V
	1680x1050	59.94				V
	1920x1200 (Reduce Blanking)	60				V
	1400x1050	60				V

Signal Type	Resolution	Frame Rate	Frame Packing	Side by Side	Top / Bottom	Fram Sequential
EDTV	1080i	59.94		✓		
	1080i	60		✓		
	720p	50	✓		✓	✓
	720p	59.94	✓		✓	✓
	720p	60	✓		✓	✓
	1080p	23.98	✓		✓	
	1080p	24	✓		✓	
	1080p	50				✓
	1080p	59.94				✓
	1080p	60				✓



- An image with higher or lower resolution than the projector's native resolution will be compressed.
- Some Sync on Green signals may not be displayed correctly.
- Signals other than those specified in the table above may not be displayed correctly. If this should happen, change the refresh rate or resolution on your PC.

RS232 command control

Function	Type	Description	ASCII
Power	Write	Power On	<CR>*pow=on#<CR>
	Write	Power off	<CR>*pow=off#<CR>
	Read	Power Status	<CR>*pow=?#<CR>
Source Selection	Write	COMPUTER/YPbPr	<CR>*sour=RGB#<CR>
	Write	COMPUTER 2	<CR>*sour=RGB2#<CR>
	Write	DVI-D	<CR>*sour=dvid#<CR>
	Write	HDMI	<CR>*sour=hdmi#<CR>
	Write	DisplayPort	<CR>*sour=dp#<CR>
	Write	HD Connect	<CR>*sour=hdconnect#<CR>
	Read	Current source	<CR>*sour=?#<CR>
Picture Setting	Write	Dynamic	<CR>*appmod=dynamic#<CR>
	Write	Presentation	<CR>*appmod=preser#<CR>
	Write	Cinema	<CR>*appmod=cine#<CR>
	Read	Picture Mode	<CR>*appmod=?#<CR>
	Write	Contrast +	<CR>*con=+#<CR>
	Write	Contrast -	<CR>*con=-#<CR>
	Read	Contrast value	<CR>*con=?#<CR>
	Write	Brightness +	<CR>*bri=+#<CR>
	Write	Brightness -	<CR>*bri=-#<CR>
	Read	Brightness value	<CR>*bri=?#<CR>
	Write	Color +	<CR>*color=+#<CR>
	Write	Color -	<CR>*color=-#<CR>
	Read	Color value	<CR>*color=?#<CR>
	Write	Sharpness +	<CR>*sharp=+#<CR>
	Write	Sharpness -	<CR>*sharp=-#<CR>
	Read	Sharpness value	<CR>*sharp=?#<CR>
	Write	Color Temperature-Warm	<CR>*ct=warm#<CR>
	Write	Color Temperature-Normal	<CR>*ct=normal#<CR>
	Write	Color Temperature-Cool	<CR>*ct=cool#<CR>
	Write	Color Temperature-lamp native	<CR>*ct=native#<CR>
	Read	Color Temperature Status	<CR>*ct=?#<CR>
	Write	Aspect 4:3	<CR>*asp=4:3#<CR>
	Write	Aspect 16:9	<CR>*asp=16:9#<CR>
	Write	Aspect 16:10	<CR>*asp=16:10#<CR>
	Write	Aspect Auto	<CR>*asp=AUTO#<CR>
	Write	Aspect Real	<CR>*asp=REAL#<CR>
	Write	Aspect Letterbox	<CR>*asp=LBOX#<CR>
	Write	Aspect 5:4	<CR>*asp=5:4#<CR>
	Write	Aspect 1.88	<CR>*asp=1.88:1#<CR>
	Write	Aspect 2.35	<CR>*asp=2.35:1#<CR>
	Read	Aspect Status	<CR>*asp=?#<CR>

Picture Setting	Write	Digital Zoom In	<CR>*zoomI#<CR>
	Write	Digital Zoom out	<CR>*zoomO#<CR>
	Write	Auto	<CR>*auto#<CR>
Operation Settings	Write	Projector Position-Front Table	<CR>*pp=FT#<CR>
	Write	Projector Position-Rear Table	<CR>*pp=RE#<CR>
	Write	Projector Position-Rear Ceiling	<CR>*pp=RC#<CR>
	Write	Projector Position-Front Ceiling	<CR>*pp=FC#<CR>
	Write	Projector Position-up Front	<CR>*pp=UF#<CR>
	Write	Projector Position-down Front	<CR>*pp=DF#<CR>
	Read	Projector Position Status	<CR>*pp=?#<CR>
	Write	Quick auto search on	<CR>*QAS=on#<CR>
	Write	Quick auto search off	<CR>*QAS=off#<CR>
	Read	Quick auto search status	<CR>*QAS=?#<CR>
	Write	Direct Power On-on	<CR>*directpower=on#<CR>
	Write	Direct Power On-off	<CR>*directpower=off#<CR>
	Read	Direct Power On-Status	<CR>*directpower=?#<CR>
	Write	Standby Settings-Standard	<CR>*standbynet=standard#<CR>
	Write	Standby Settings-Eco	<CR>*standbynet=eco#<CR>
	Write	Standby Settings-Network	<CR>*standbynet=network#<CR>
	Write	2400	<CR>*baud=2400#<CR>
	Write	4800	<CR>*baud=4800#<CR>
	Write	9600	<CR>*baud=9600#<CR>
	Write	14400	<CR>*baud=14400#<CR>
	Write	19200	<CR>*baud=19200#<CR>
	Write	38400	<CR>*baud=38400#<CR>
	Write	57600	<CR>*baud=57600#<CR>
	Write	115200	<CR>*baud=115200#<CR>
Read	Current Baud Rate	<CR>*baud=?#<CR>	
Lamp Control	Read	Lamp Hour	<CR>*ltim=?#<CR>
	Read	Lamp2 Hour	<CR>*ltim2=?#<CR>
	Write	Lamp hour reset	<CR>*ltim=reset#<CR>
	Write	Lamp2 hour reset	<CR>*ltim2=reset#<CR>
	Write	Normal mode	<CR>*lampm=lnor#<CR>
	Write	Eco mode	<CR>*lampm=eco#<CR>
	Read	Lamp Mode Status	<CR>*lampm=?#<CR>
	Write	Dual lamp	<CR>*lammd=dual#<CR>
	Write	number 1 lamp	<CR>*lammd=num1#<CR>
	Write	number 2 lamp	<CR>*lammd=num2#<CR>
	Write	Single lamp (minimum)	<CR>*lammd=single#<CR>
	Read	Current Lamp status	<CR>*lammd=?#<CR>

Miscellaneous	Read	Model Name	<CR>*modelname=?#<CR>
	Write	Blank On	<CR>*blank=on#<CR>
	Write	Blank Off	<CR>*blank=off#<CR>
	Read	Blank Status	<CR>*blank=?#<CR>
	Write	Freeze On	<CR>*freeze=on#<CR>
	Write	Freeze Off	<CR>*freeze=off#<CR>
	Read	Freeze Status	<CR>*freeze=?#<CR>
	Write	Menu On	<CR>*menu=on#<CR>
	Write	Menu Off	<CR>*menu=off#<CR>
	Read	Menu Status	<CR>*menu=?#<CR>
	Write	Up	<CR>*up#<CR>
	Write	Down	<CR>*down#<CR>
	Write	Right	<CR>*right#<CR>
	Write	Left	<CR>*left#<CR>
	Write	Enter	<CR>*enter#<CR>
	Write	3D Sync Off	<CR>*3d=off#<CR>
	Write	3D Auto	<CR>*3d=auto#<CR>
	Write	3D Sync Top Bottom	<CR>*3d=tb#<CR>
	Write	3D Sync Frame Sequential	<CR>*3d=fs#<CR>
	Write	3D Frame packing	<CR>*3d=fp#<CR>
	Write	3D Side by side	<CR>*3d=sbs#<CR>
	Write	3D inverter disable	<CR>*3d=da#<CR>
	Write	3D inverter	<CR>*3d=iv#<CR>
	Read	3D Sync Status	<CR>*3d=?#<CR>
	Write	Remote Set	<CR>*rrset=0#<CR>
	Read	Remote Set Status	<CR>*rrset=?#<CR>
	Write	Trigger on	<CR>*trigger=on#<CR>
	Write	Trigger off	<CR>*trigger=off#<CR>
	Read	Trigger status	<CR>*trigger=?#<CR>
	Write	High Altitude mode on	<CR>*Highaltitude=on#<CR>
	Write	High Altitude mode off	<CR>*Highaltitude=off#<CR>
	Read	High Altitude mode status	<CR>*Highaltitude=?#<CR>
	Read	Error Code	<CR>*error=report#<CR>
	Write	Lens Shift Up	<CR>*lst=up#<CR>
	Write	Lens Shift Down	<CR>*lst=down#<CR>
	Write	Lens Shift Left	<CR>*lst=left#<CR>
	Write	Lens Shift Right	<CR>*lst=right#<CR>
	Write	Focus Plus	<CR>*focus=+#<CR>
	Write	Focus Minus	<CR>*focus=-#<CR>
	Write	Zoom Plus	<CR>*zoom=+#<CR>
	Write	Zoom Minus	<CR>*zoom=-#<CR>
	Write	Keystone-Vertical Decrease	<CR>*keyst=-#<CR>
	Write	Keystone-Vertical Increase	<CR>*keyst=+#<CR>
	Read	Keystone-Vertical Status	<CR>*keyst=?#<CR>

Control the projector through a network

Set up the projector for networking

DISPLAY	PICTURE	LAMPS	ALIGNMENT	CONTROL	SERVICE
Standby Mode		< Standard >		Network	
Auto Power off		< Off >		IP Address	< XXX.XXX.XXX.XXX >
Direct Power On		< Off >		Subnet	< 255.255.255.0 >
Network		Enter		Gateway	< XXX.XXX.XXX.XXX >
RS232		Enter		DHCP	Off
Startup Logo	< Off >			Apply	Enter
Trigger	< Off >				
Auto Search	< Off >				
Dynamic Black	< Off >				
3D		Enter			
Language		Enter			

Caution:

Please set DHCP option to Off and select Apply to activate it. The DHCP service assigns an IP address and settings. The IP address, Subnet and Gateway options will be dimmed and not available for selection. If the LAN does not support DHCP service, please press ▲ ▼ and Enter key to select network and its settings:

IP Address: To specify an IP address, press the Enter button to show the IP address input window. Use the ◀ ▶ button to select the number in the address to be changed. Use the ▲ ▼ button to increase or decrease the number in the IP address.

Network	
IP Address	172.100.100.100

Subnet: Set up the subnet address in the same way as for the IP Address setup.

Gateway: Set up the gateway address in the same way as for the IP Address setup.

DHCP: Set DHCP to On or Off. If this is set to On, the DHCP server of network domain will assign an IP address to the projector. That is, the IP address will display in the address window instead of having to be manually entered. Otherwise, the domain does not or cannot assign an IP address, and 0.0.0.0 is shown on the IP address window.

Apply: Select this button and press Enter. It takes the projector several seconds to execute the change in network setting until the following message disappears.

Setting network configuration, please wait

Please contact your network administrator if the network remains disconnected.

Control the projector through a web browser

Open a web browser and enter the projector's IP address. Its home page with four options will display:

Projector Status: Current projector settings.

Alert Mail Setup: Settings for projector abnormality email reminders. In case of any abnormality the projector sends emails to preset users.

Crestron: Crestron compatible network browser control page

PJLink: This page lets you set up a security password for PJLink connection.

Projector Status

The following illustrates a projector with IP address "192.168.0.100":

System	
Model Name	PW9620
Software Version	ME02
System Status	Power On
Display Source	VGA
Lamp 1 Hours	19
Lamp 2 Hours	5
Error Status	(No Error)
RJ45 Version	
LAN Version	RE07
IP address	192.168.0.101
Subnet mask	255.255.255.0
Default gateway	0.0.0.0
DNS Server	0.0.0.0
MAC address	00:18:23:00:00:88

System

Model Name	: Model number of the projector
Software Version	: Version of projector system software
System Status	: Current projector power on status
Display Source	: Current input signal
Lamp 1 Hours	: Use hours of lamp 1
Lamp 2 Hours	: Use hours of lamp 2
Error Status	: Display projector error messages

Network control setup information (RJ-45 Version)

Lan Version	: Version of network control software
IP address	: Current IP address
Subnet mask	: Current subnet setting
Default gateway	: Current gateway setting
DNS server	: Current DNS server setting
MAC address	: Preset MAC address

Alert mail setup

The projector can send alert messages with Email to predefined users. Make the following settings before enabling this function:

- SMTP Sever : Set up name of SMTP server for the projector's sending reminder email.
- Port : Set up transmission port
- User Name : Set up user name for the projector's sending reminder email through SMTP server.
- Password : Set up user password.
- E-mail Alert : Enable or disable E-mail Alert function.
- From : Set up sender's email address.
- To : Set up recipient's email address.
- CC : Set up CC recipient's email address.
- Projector Name : Set up projector name or ID
- Location : Set up installation location of projector.
- Apply : Accept settings. Press this button to save the changes made.
- Send Test Mail : Send test email to validate your settings. The reminder email is sent only in the event of a projector error. Press this button to validate email settings after setup is completed.

Crestron control page

Click the Crestron option in your projector's home page to display its control page in a new tab.



Power: Press to power on or off your projector.

Source List: Switch among list of available projector input signal sources. Press the ▲ (at top of screen) or ▼ (at bottom of screen) arrow key to scroll through the list.

Image adjust options

Press the ◀ (to the left of screen) or ▶ (to the right of screen) arrow key to scroll through other adjustment options.

Freeze: Freeze current projection screen. The projection screen prompts "Freeze" message once the freeze function is enabled. Press the Freeze button again to unfreeze the image.

Contrast: Press to display the adjustment window, click ◀▶ arrow key to adjust contrast.



Brightness: Press to display the adjustment window, click ◀▶ arrow key with the mouse to adjust brightness.



Sharpness: Press to display the adjustment window, click ◀▶ arrow key with the mouse to adjust sharpness.



Zoom: Zoom in on the projection image. Click "+" key to zoom in and "-" to zoom out. Click the four arrow keys in the window to move the zoomed projection image.



Control key window

This window simulates keys on the remote controller and control panel.

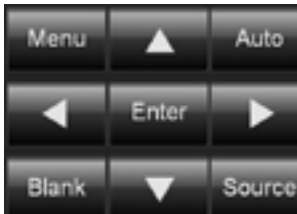

Enter: Confirm the changes and select the OSD option

Menu: Press to display the OSD menu. Press again to exit it.

Auto: Execute the auto image adjustment function.

Blank: Pause the image projection, i.e. the projection image is masked. Press again to resume the projection.

Source: Display list of signal sources.

Tool: Set up options to work with Creston compatible devices. See relevant manuals for detailed setup steps.

Info: Display current projector status and Creston settings.

Control your projector with PJLink commands

PJLink is a standard designed by the Japan Business Machine and Information System Industries Association (JBMA) to control projectors with genuine commands. A projector featuring PJLink functions can be controlled with standard commands regardless of who made it. This product supports PJLink control commands. Please set up password for PJLink connection on this page.

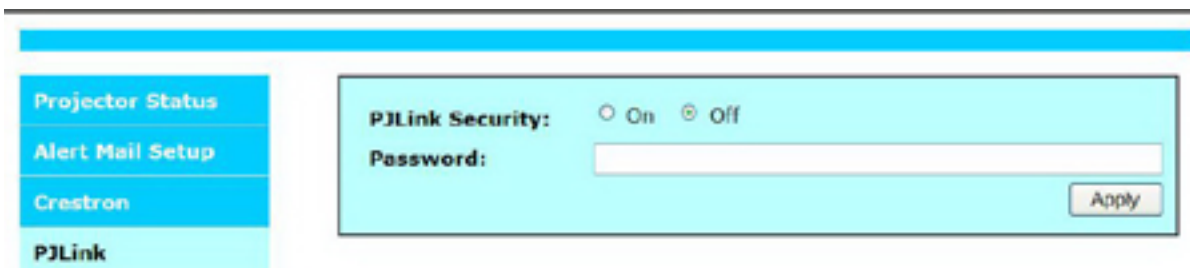

PJLink Security: Select On to enable PJLink security password or Off to disable it.

Password: Set up security password at length of up to 32 characters.

See PJLink official web site for standard commands and connection methods.

Troubleshooting

Indicator messages

Several indicator messages are used by the projector to alert users of problems with setup or system error. The LEDs on top cover of the projector are as below illustration.

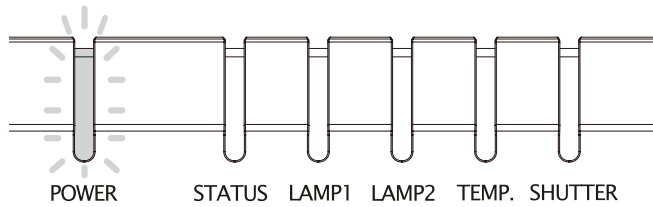

Power LED indicator

LED display		Projector status	Operation tips
Close		AC power turned off	Turn on AC power and power on the projector
Flashing	Green	Ready to power on the projector	Wait until the projector starts projecting
	Orange	The projector is cooling down	Wait for about 120 seconds until the projector cools down.
Lights up	Red	Standby mode	To power on the projector, press the ON key on the remote controller or the Power key on the control panel.
	Green	Projector powered on	

LED status indicator light

LED display		Projector status	Operation tips
Close		Normal	
Flashing	Red (once)	Cover error	Please check whether the color wheel door is well installed or not. If the problem persists, call the local service center.
	Red (quadruple)	Fan error	Call the local service center.
Lights up	Red	System error	Call the local service center.

Lamp 1/Lamp 2 LED indicator

LED display		Projector status	Operation tips
Close		Lights off	
Flashing	Green	Ready to light up	
	Red (6 times)	Lamp fails to light up	Call the local service center.
Lights up	Red	Lamp life expires	Call the local service center.
	Green	Indicates the projector lamp is working	

Temperature LED indicator

LED display		Projector status	Operation tips
Close		Normal	
Flashing	Red	Temperature error	Please check for dirty filter, blocked intake or exhaust opening, and fan settings. If the problem persists, call the local service center.

Shutter LED

LED display		Projector status	Operation tips
Close		Shutter opened	
Flashing	Green	Shutter closed	

Common problems and solutions

These guidelines provide tips to deal with problems you may encounter while using the projector. If the problem remains unsolved, contact your dealer for assistance. Often the problem is something as simple as a loose connection. Check the following before proceeding to the problem-specific solutions.

- Use some other electrical device to confirm that the electrical outlet is working.
- Ensure the projector is turned on.
- Ensure all connections are securely attached.
- Ensure the attached device is turned on.
- Ensure a connected PC is not in suspend mode.
- Ensure a connected notebook computer is configured for an external display. (This is usually done by pressing an Fn-key combination on the notebook.)

Tips for troubleshooting

In each problem-specific section, try the steps in the order suggested. This may help you to solve the problem more quickly.

Try to pinpoint the problem to avoid replacing non-defective parts.

For example, if you replace batteries and the problem remains, put the original batteries back and go to the next step.

Keep a record of the steps you take when troubleshooting: The information may be useful when calling for technical support or for passing on to service personnel.

Image problems

Problem: No image appears on the screen

1. Verify the settings on your notebook or desktop PC.
2. Turn off all equipment and power up again in the correct order.

Problem: The image is blurred

1. Adjust the Focus on the projector .
3. Press the AUTO SYNC button on the remote control or projector.
4. Ensure the projector-to-screen distance is within the specified range.
5. Check that the projector lens is clean.
6. Remove the lens cover.

Problem: The image is wider at the top or bottom (trapezoid effect)

1. Position the projector so it is as perpendicular to the screen as possible.
2. Use the Keystone button on the remote control to correct the problem. Problem: The image is reversed or upside down

Check the Ceiling & Rear setting on the Setting menu of the OSD.

Problem: The image is streaked

1. Adjust the Phase and Clock on the Signal menu of the OSD to the default settings.
2. To ensure the problem is not caused by a connected PC's video card, connect to another computer.

Problem: The image is flat with no contrast

1. Adjust the Contrast setting on the Picture menu of the OSD.
2. Adjust the Brightness setting on the Picture menu of the OSD.

Problem: The color of the projected image does not match the source image.

Adjust the Color temperature and Picture settings.

Lamp problems

Problem: There is no light from the projector

1. Check that the power cable is securely connected.
2. Ensure the power source is good by testing with another electrical device.
3. Restart the projector in the correct order and check that the Power LED is green.
4. If you have replaced the lamp recently, try resetting the lamp connections.
5. Replace the lamp module.
6. Remove the lens cap.
7. Put the old lamp back in the projector and have the projector serviced.

Problem: The lamp goes off

8. Power surges can cause the lamp to turn off. Press the power button twice to turn off the projector. When the Power LED is orange, press the power button.
9. Replace the lamp module.
10. Put the old lamp back in the projector and have the projector serviced.

Problem: The lamp goes off

8. Power surges can cause the lamp to turn off. Press the power button twice to turn off the projector. When the Power LED is orange, press the power button.
9. Replace the lamp module.
10. Put the old lamp back in the projector and have the projector serviced.

Remote control problems

Problem: The projector does not respond to the remote control

1. Direct the remote control towards remote sensor on the projector.
2. Ensure the path between remote and sensor is not obstructed.
3. Turn off any fluorescent lights in the room.
4. Check the battery polarity.
5. Replace the batteries.
6. Turn off other Infrared-enabled devices in the vicinity.
7. Have the remote control serviced.
8. Ensure that the remote control code conforms to the projector's code.
9. Ensure that the reset switch in the compartment lid on back of the remote control is set to use position.

BenQ ecoFACTS

BenQ has been dedicated to the design and development of greener product as part of its aspiration to realize the ideal of the "Bringing Enjoyment 'N Quality to Life" corporate vision with the ultimate goal to achieve a low-carbon society. Besides meeting international regulatory requirement and standards pertaining to environmental management, BenQ has spared no efforts in pushing our initiatives further to incorporate life cycle design in the aspects of material selection, manufacturing, packaging, transportation, using and disposal of the products. BenQ ecoFACTS label lists key eco-friendly design highlights of each product, hoping to ensure that consumers make informed green choices at purchase. Check out BenQ's CSR Website at <http://csr.BenQ.com/> for more details on BenQ's environmental commitments and achievements.



Copyright

Copyright 2014 BenQ Corporation. All rights reserved. No part of this publication may be reproduced, transmitted, transcribed, stored in a retrieval system or translated into any language or computer language, in any form or by any means, electronic, mechanical, magnetic, optical, chemical, manual or otherwise, without the prior written permission of BenQ Corporation.

All other logos, products, or company names mentioned in this manual may be the registered trademarks or copyrights of their respective companies, and are used for informational purposes only.

Disclaimer

BenQ Corporation makes no representations or warranties, either expressed or implied, with respect to the contents hereof and specifically disclaims any warranties, merchantability or fitness for any particular purpose. Further, BenQ Corporation reserves the right to revise this publication and to make changes from time to time in the contents hereof without obligation of BenQ Corporation to notify any person of such revision or changes.

This user manual aims to provide the most updated and accurate information to customers, and thus all contents may be modified from time to time without prior notice. Please visit <http://www.benq.com> for the latest version of this manual.

Statement regarding hyperlinks and third-party websites

BenQ is not responsible for the content of the websites or of similar resources, which are maintained and controlled by third parties, that may be linked from this product. Providing links to those websites or to similar resources does not mean that BenQ makes any warranty or representation to their content by expression or by implication.

Any third party content or service preinstalled in this product is provided "as is". BenQ does not, by expression or by implication, make any warrant to the content or to the services provided by third parties. BenQ does not warrant or guarantee that the content or services provided by third parties are accurate, effective, most up-to-date, legal, or complete. Under no circumstances shall BenQ be liable for the content or services provided by third parties including their negligence. Services provided by third parties may be terminated temporarily or permanently. BenQ does not warrant or guarantee that the any content or services provided by third parties are in good condition at any time, and is not liable for the termination of the said content and services. In addition, BenQ is not involved in any transactions you conduct in the websites or similar resources maintained by third parties.

You should contact the content or service providers for any questions, concerns, or disputes.