



DOCUMENT CAMERA
P30S
INSTRUCTION MANUAL

Please read this instruction manual carefully before using this product and keep it for future reference.

IMPORTANT SAFEGUARDS

■ **Read Instructions** – All the safety and operating instructions should be read before the appliance is operated.

■ **Retain Instructions** – The safety and operating instructions should be retained for future reference.

■ **Heed Warnings** – All warnings on the product and in the operating instructions should be adhered to.

■ **Follow Instructions** – All operating and use instructions should be followed.

■ **Cleaning** – Unplug this product from the wall outlet before cleaning. Do not use liquid cleaners or aerosol cleaners. Use a damp cloth for cleaning.

■ **Attachments** – Do not use attachments not recommended by the product manufacturer as they may cause hazards.

■ **Water and Moisture** – Do not use this product near water - for example, near a bath tub, wash bowl, kitchen sink, or laundry tub, in a wet basement, or near a swimming pool, and the like.

■ **Placement** – Do not place this product on an unstable cart, stand, tripod, bracket, or table. The product may fall, causing serious injury to a child or adult, and serious damage to the product. Use only with a cart, stand, tripod, bracket, or table recommended by the manufacturer, or sold with the product. Any mounting of the product should follow the manufacturer's instructions, and should use a mounting accessory recommended by the manufacturer.

■ **Ventilation** – Slots and openings in the cabinet are provided for ventilation and to ensure reliable operation of the product and to protect it from overheating, and these openings must not be blocked or covered. The openings should never be blocked by placing the product on a bed, sofa, rug, or other similar surface. This product should not be placed in a built-in installation such as a bookcase or rack unless proper ventilation is provided or the manufacturer's instructions have been adhered to.

■ **Power Sources** – This product should be operated only from the type of power source indicated on the marking label. If you are not sure of the type of power supply to your home consult your appliance dealer or local power company. For products intended to operate from battery power, or other sources, refer to the operating instructions.

■ **Grounding or Polarization** – This product may be equipped with either a polarized 2-wire AC line plug (a plug having one blade wider than the other) or a 3-wire grounding type plug, a plug having a third (grounding) pin. The 2-wire polarized plug will fit into the power outlet only one way. This is a safety feature. If you are unable to insert the plug fully into the outlet, try reversing the plug.

If the plug still fails to fit, contact your electrician to replace your obsolete outlet. Do not defeat the safety purpose of the polarized plug. The 3-wire grounding type plug will fit into a grounding type power outlet. This is a safety feature. If you are unable to insert the plug into the outlet, contact your electrician to replace your obsolete outlet. Do not defeat the safety purpose of the grounding type plug.

■ **Power-Cord Protection** – Powersupply cords should be routed so that they are not likely to be walked on or pinched by items placed upon or against them, paying particular attention to cords at plugs, convenience receptacles, and the point where they exit from the product.

■ **Lightning** – For added protection for this product during a lightning storm, or when it is left unattended and unused for long periods of time, unplug it from the wall outlet and disconnect the antenna or cable system. This will prevent damage to the product due to lightning and power-line surges.

■ **Overloading** - Do not overload wall outlets, extension cords, or integral convenience receptacles as this can result in a risk of fire or electric shock.

■ A product and cart combination should be moved with care. Quick stops, excessive force, and uneven surfaces may cause the product and cart combination to overturn.



■ **Object and Liquid Entry** - Never push objects of any kind into this product through openings as they may touch dangerous voltage points or short-out parts that could result in a fire or electric shock. Never spill liquid of any kind on the product.

■ **Servicing** - Do not attempt to service this product yourself as opening or removing covers may expose you to dangerous voltage or other hazards. Refer all servicing to qualified service personnel.

■ **Damage Requiring Service –** Unplug this product from the wall outlet and refer servicing to qualified service personnel under the following conditions:

- When the power-supply cord or plug is damaged.
- If liquid has been spilled, or objects have fallen into the product.
- If the product has been exposed to rain or water.
- If the product does not operate normally by following the operating instructions. Adjust only those controls that are covered by the operating instructions as an improper adjustment of other controls may result in damage and will often require extensive work by a qualified technician to restore the product to its normal operation.
- If the product has been dropped or damaged in any way.
- When the product exhibits a distinct change in performance - this indicates a need for service.

■ **Replacement Parts –** When replacement parts are required, be sure the service technician has used replacement parts specified by the manufacturer or have the same characteristics as the original part. Unauthorized substitutions may result in fire, electric shock or other hazards.

■ **Safety Check –** Upon completion of any service or repairs to this product, ask the service technician to perform safety checks to determine that the product is in proper operating condition.

■ **Heat –** The product should be situated away from heat sources such as radiators, heat registers, stoves, or other products (including amplifiers) that produce heat.

■ This product includes a Fluorescent Lamps component that contains mercury. Please consult your state and local regarding proper disposal or recycling, and do not place in the trash.

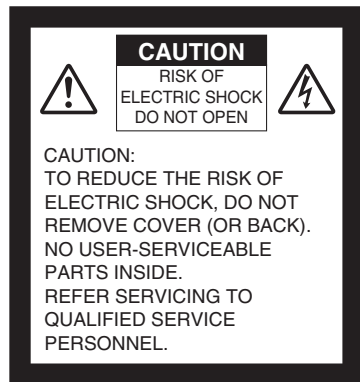

SA 1965

The lightning flash with arrowhead symbol, within an equilateral triangle, is intended to alert the user to the presence of uninsulated "dangerous voltage" within the product's enclosure that may be of sufficient magnitude to constitute a risk of electric shock to persons. This marking is located at the bottom of product.



SA 1966

The exclamation point within an equilateral triangle is intended to alert the user to the presence of important operating and maintenance (servicing) instructions in the literature accompanying the product.

WARNING:
TO REDUCE THE RISK
OF FIRE OR ELECTRIC
SHOCK, DO NOT
EXPOSE THIS PRODUCT
TO RAIN OR MOISTURE.

THIS IS A CLASS A
PRODUCT.
IN A DOMESTIC
ENVIRONMENT THIS
PRODUCT MAY CAUSE
RADIO INTERFERENCE
IN WHICH CASE THE
USER MAY BE
REQUIRED TO TAKE
ADEQUATE MEASURES.

WARNING : Handling the cord on this product or cords associated with accessories sold with this product, will expose you to lead, a chemical known to the State of California to cause birth defects or other reproductive harm.

Wash hands after handling.

FOR UNITED STATES
USERS:

INFORMATION

This equipment has been tested and found to comply with the limits for a Class A digital device, pursuant to Part 15 of the FCC Rules. These limits are designed to provide reasonable protection against harmful interference when the equipment is operated in a commercial environment. This equipment generates, uses, and can radiate radio frequency energy and, if not installed and used in accordance with the instruction manual, may cause harmful interference to radio communications. Operation of this equipment in a residential area is likely to cause harmful interference in which case the user will be required to correct the interference at his own expense.

USER-INSTALLER **CAUTION:**

Your authority to operate this FCC verified equipment could be voided if you make changes or modifications not expressly approved by the party responsible for compliance to Part 15 of the FCC rules.

BEFORE YOU USE

- Be sure to use the power cord and AC adapter attached to this camera system as accessories.
- The power cord applicable to the local power specifications is attached. Be sure to use the power cord applicable to your local power specification.
- Do not leave this product under direct sunlight or by heaters, or this product may be discolored, deformed, or damaged.
- Do not place this product in any humid, dusty, windy or vibrating location. Use this product in the following environmental conditions:
 - Temperature: 0°C~40°C (32°F~104°F)
 - Humidity: 30%~85% (No condensation)
- In handling (including setting up and storing) or carrying the camera, be meticulously careful not to give an impact on the camera head.
- To prevent dropping and falling, observe the following:
 - Use the camera on a stable stand, desk or table. Never put the camera on any shaky stand or inclined or instable place.
 - Before using, lay out the power cord, the AC adapter cable and the video cable not to be pulled, and wire them accordingly.
- Do not move the camera column or the lamp column while your finger is being placed between the camera column and the lamp column. Otherwise, your finger may be pinched and injured.
- Use a soft, dry cloth for cleaning. Do not use any volatile solvent, such as thinner or benzine.
- Do not directly point the camera lens into the sun, or the camera may be damaged.
- Caring for the batteries:
 - If this camera system is not used for a long time, take out the batteries from the wireless remote control.
 - Do not use rechargeable batteries (e.g., Ni-Cd).
 - Do not use new and old batteries, or batteries of different types together.
 - Do not try to recharge or short-circuit the batteries.
 - When disposing of used batteries, follow the instructions from each local government.
- Luminescent and Black Spots
This camera has a CMOS area image sensor and a color LC panel, which are composed of many pixels. Some of these pixels may not operate normally. As a result, a luminescent spot or a black spot may appear on the output screen. However, this is a phenomenon unique to the CMOS area image sensor and color LC panel and therefore this phenomenon is not faulty.
- Do not press the LC panel strongly or with a sharp-pointed object, or it would cause break or failure to the color LC panel.

- Transfer the data in an SD card to a PC or other data storage means for backup purpose. Note with care that the data in the SD card could be lost due to failure or repair of this product.
- Do not look into the lamp (LED) part directly at close range. It may damage your eyes.
- When this Camera is used longer than the warranty period, some parts may deteriorate in performance or quality due to the expiration of the service life. In this case, we will replace such parts with payment. Consult the sales outlet from whom you have purchased this Camera or our branch or sales office nearest your location.

CONTENTS

IMPORTANT SAFEGUARDS	82
BEFORE YOU USE	86
OUTLINE OF THIS CAMERA	89
Part Names and Functions	89
OSD (On Screen Display)	97
Receiving by Wireless Remote Control	103
How to Attach Wireless Remote Control Holder	104
How to Set up the Camera	105
Connecting AC Adapter and Video Cable	107
How to Store The Camera	111
OPERATION OF THIS CAMERA	112
Turning ON/OFF Power Supply	112
Basic Operation of OSD	113
Turning ON/OFF Lamp	115
Adjusting Zoom	117
Switching Video	118
Adjusting Focus	119
Adjusting Brightness	121
Adjusting White Balance	123
Presetting and Calling	125
Using SD Card (Option)	126
Using Bundled Software	141
Shooting off the Stage	144
Presentation Using Films	145
ABOUT RS-232C	146
Connecting RS-232C	146
Specifications of RS-232C	147
APPENDIX	152
Troubleshooting	152
Specifications	154
Accessories	157

OUTLINE OF THIS CAMERA

Part Names and Functions

Appearance - Front and Side

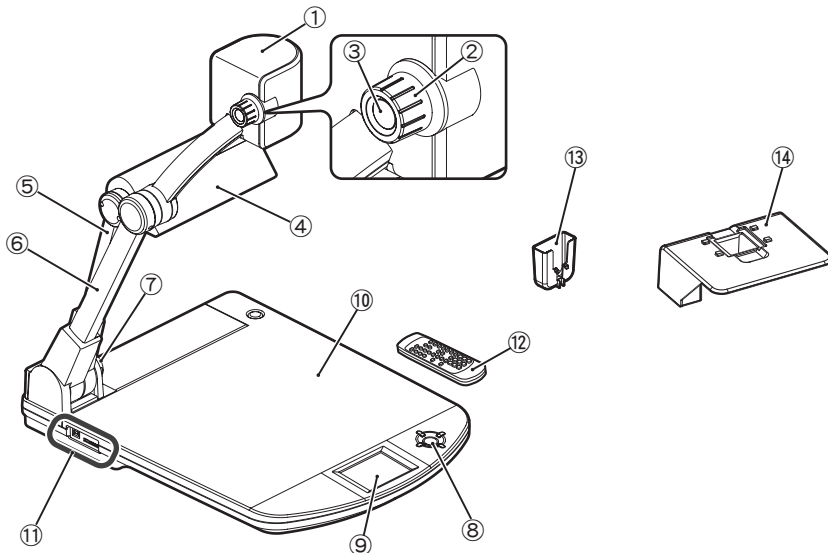

	Name	Reference page
①	Camera head	—
②	Zoom dial	P.117
③	AF button	P.119
④	Lamp head	—
⑤	Lamp column	—
⑥	Camera column	—
⑦	Wireless remote control sensor unit	—
⑧	Front operating panel	P.91
⑨	LCD panel	—
⑩	Stage	—
⑪	Side panel (SD/USB)	P.93
⑫	Wireless remote control	P.94
⑬	Wireless remote control holder	P.104
⑭	Slide shooting adapter	P.145

Note:

- Do not move the camera column or the lamp column while your finger is being placed between the camera column and the lamp column. Otherwise, your finger may be pinched and injured.

Appearance - Rear

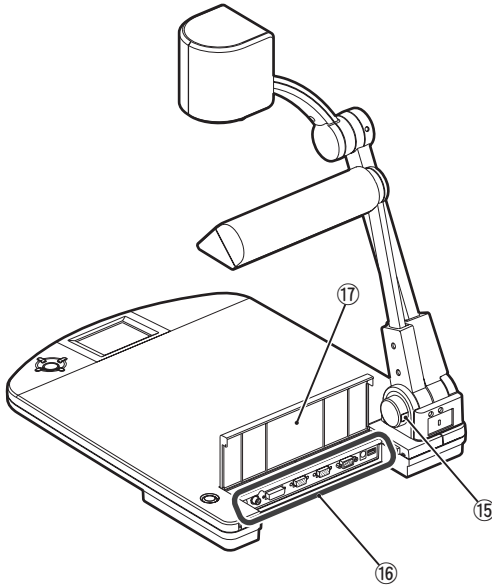

	Name	Reference page
⑮	Wireless remote control sensor unit	—
⑯	Rear panel	P.92
⑰	Cord cover	—

Note:

- The wireless remote control sensor unit is also located on the front side.
- When plugging/unplugging the cord, open the cord cover.
- When carrying the Camera, do not hold on to the cord cover.

Front Operating panel

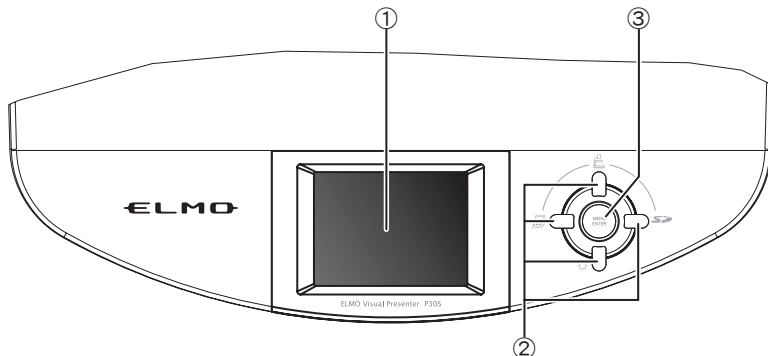

Condition	Name	Function	Reference page	
①	—	LCD panel	To display the output video and the OSD.	—
②	OSD HIDE MENU	▲ (up) button	To switch the output video to the camera video, and the color of the front operating panel LED to blue.	P.118
		▼ (down) button	To switch the ON/OFF of the lamp.	P.115
		▶ (right) button	To switch the mode of the output video to the SD mode, and the color of the front operating panel LED to orange.	P.118
		◀ (left) button	To switch the output video to the RGB IN video, and the color of the front operating panel LED to pink.	P.118
	SD Mode	▶ (right) button	To display the next image.	P.128
OSD Menu	▲▼◀▶ (up, down, left, right) buttons	To be used for selecting the menu item.	P.113	
③	—	MENU/ENTER button	To be used for displaying the OSD menu and selecting the menu item.	P.113

*The function for use in viewing images saved on the SD card is called "SD mode." (When the OSD menu is in display, this function is disabled.)

*When [HIDE MENU] on the OSD SD Single menu or OSD SD Split screen menu is ON, the condition "OSD HIDE MENU" of ② cannot be operated.

*The menu items displayed on the screen are called "OSD (On Screen Display)," and the OSD displaying status is called "OSD menu."

Note:

- The LCD panel of this Camera is not a touch panel.
- Do not push the LCD panel strongly or push it with a sharp instrument. Otherwise, the LCD panel may be damaged.

Rear Panel

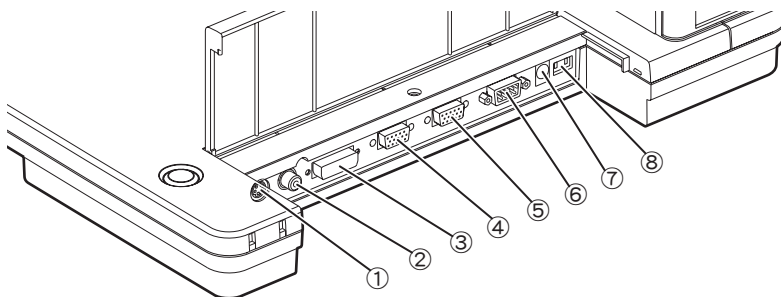





	Name	Function	Reference page															
①	S-VIDEO OUT (S-Video Output Terminal)	To output video from the Mini DIN4P terminal to the NTSC/PAL-system monitor (e.g., TV monitor).	P.110															
②	VIDEO OUT (Composite Video Output Terminal)	To output video from the RCA pin-jack terminal to the NTSC/PAL-system monitor (e.g., TV monitor).	P.109															
③	DVI OUT (DVI Output Terminal)	To output digital video signal to the DVI input device (e.g., projector, PC monitor).	P.108															
④	RGB OUT (Analog RGB Output Terminal)	To output analog video signal to the RBG input device (e.g., projector, PC monitor).	P.108															
⑤	RGB IN (Analog RGB Input Terminal)	To output the input video from the analog RGB output terminal when [RGB IN] is selected in the Display mode.	P.109															
⑥	RS-232C (RS-232C Terminal)	To control the main body from the PC through the connected RS-232C cable.	P.146															
⑦	12VDC IN (Power Socket)	A plug-in receptable for the AC adapter.	P.107															
⑧	DIP Switch  A B C D Display of Rear panel	To execute the following switching: [A] key: Invalid [B] key: Invalid [C] key: To switch the video output system [D] key: To switch the video output screen size. <table border="1" data-bbox="392 1300 851 1364"> <thead> <tr> <th></th> <th>[A] key</th> <th>[B] key</th> <th>[C] key</th> <th>[D] key</th> </tr> </thead> <tbody> <tr> <td>0</td> <td>Invalid</td> <td>Invalid</td> <td>NTSC</td> <td>Over-scan</td> </tr> <tr> <td>1</td> <td></td> <td></td> <td>PAL</td> <td>Under-scan</td> </tr> </tbody> </table>		[A] key	[B] key	[C] key	[D] key	0	Invalid	Invalid	NTSC	Over-scan	1			PAL	Under-scan	—
	[A] key	[B] key	[C] key	[D] key														
0	Invalid	Invalid	NTSC	Over-scan														
1			PAL	Under-scan														

Note:

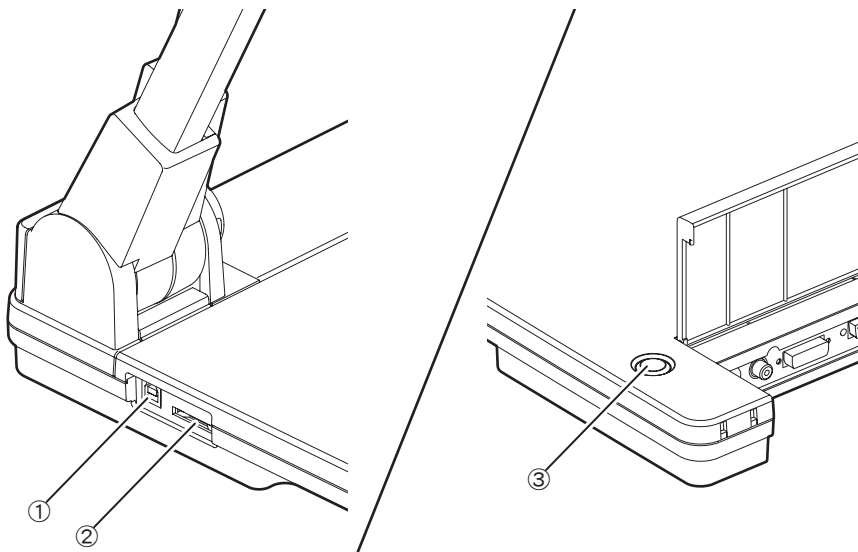
- When changing the DIP switch key settings, be sure to turn OFF the power supply to the main unit beforehand.
- The defaults of the DIP switch vary depending on the place where the Camera is used.









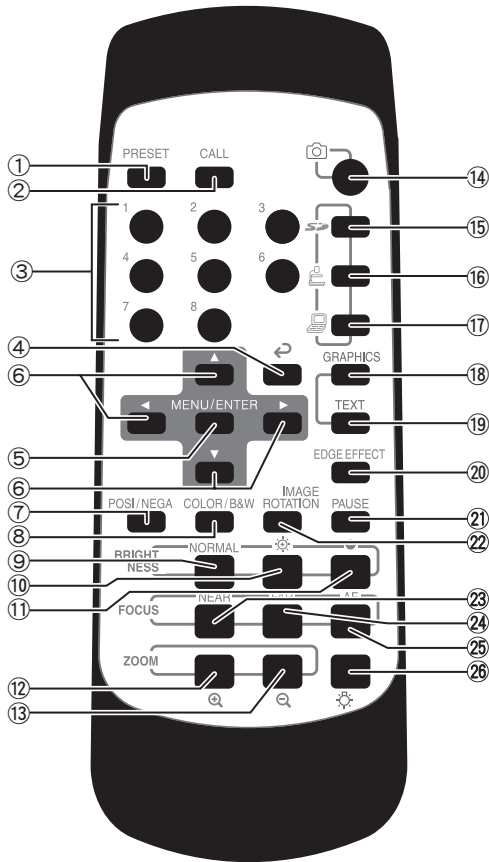

Side Panel



	Name	Function	Reference page
①	 (USB 2.0 complied)	To control the video transfer or main unit by using the bundled utility software on the "Utility Software CD-ROM" through the connected PC.	P.138
②	 (SD Card Slot)	To insert the SD card. To remove SD card, push the SD card again, and the SD card will be released.	P.126
③	 (Main Switch)	To turn ON/OFF the power supply to the main unit.	P.112

Wireless Remote Control



Name		Function	Reference page	
①	PRESET	To save the current setting status of the unit Used together with the memory No.	P.125	
②	CALL	To call up the saved setting status Used together with the memory No.	P.125	
③	MEMORY NO.	To display the memory No.	P.125	
④	 (BACK)	To return the display of the OSD menu to the previous one.	P.97	
⑤	MENU/ENTER	To display the OSD menu or fix the OSD menu item.	P.97	
⑥		To select the OSD menu item and scroll the screen when the digital zoom is in operation. To feed forward/backward the saved images in the SD mode.	P.117 P.128	
⑦	POSI/NEGA	To switch the Posi/Nega of the camera video.	—	
⑧	COLOR/B&W	To switch the Color/B&W of the camera video. Used to facilitate the visualization of the B&W material.	—	
⑨	BRIGHT NESS	NORMAL	To reset the auto brightness adjustment degree to the normal status.	P.121
⑩		 (BRIGHT)	To brighten the camera video.	P.121
⑪		 (DARK)	To darken the camera video.	P.121
⑫	ZOOM	 (TELE- SCOPIC)	To set the zoom to the TELESCOPIC side.	P.117
⑬		 (WIDE- ANGLE)	To set the zoom to the WIDE-ANGLE side.	P.117
⑭	 (CAPTURE)	To save the image on the SD card.	P.127	
⑮	 (SD MODE)	To switch the mode of the output video to the SD mode.	P.118	
⑯	 (CAMERA)	To switch the output video to the camera video.	P.118	
⑰	 (PC)	To switch the output video to the RGB IN video.	P.118	
⑱	GRAPHICS	To switch the mode to the Graphic mode to enhance the color object (e.g., drawing, photo).	—	
⑲	TEXT	To switch the mode to the Text mode to sharpen the B&W characters and lines. Used for shooting the material (e.g., document).	—	
⑳	EDGE EFFECT	To switch "1/2/3/OFF" of the edge effect to provide the edge effect processing to the video to sharpen the video. This switching is enabled only when the mode is switched to the Graphic mode.	—	

Name		Function	Reference page
⑳	PAUSE	To pause the camera video. Pressing this button again will resume the camera video.	—
㉑	IMAGE ROTATION	To rotate the camera video by 180°.	P.144
㉒	FOCUS	NEAR	To move the focus to the near side.
㉓		FAR	To move the focus to the far side.
㉔		AF (Auto Focus)	To bring the Camera into focus automatically.
㉕	 (LAMP)	To switch the ON/OFF of the lamp.	P.115

Note:

- It is impossible to add another processing to the video in pause.

OSD (On Screen Display)

The menu items displayed/selected on the monitor or projection screen are called "OSD (On Screen Display)".

This manual calls the OSD displaying status "OSD menu".

OSD Main Menu

When the output video is switched to the camera video as per "Switching Video" (P.118) and the [MENU/ENTER] button is pressed, the OSD Main menu appears.

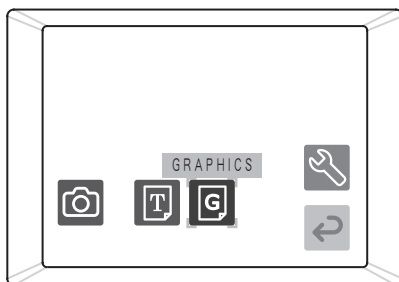

Icon	Name	Condition	Selection item	Function
	CAPTURE	—	—	To save the image on the SD card.
	TEXT		— ✓	To switch [TEXT1/2/3] set in [TEXT SETTING] of the setting menu to sharpen the B&W characters and lines. Used for shooting the material (e.g., document).
	GRAPHICS	—	—	To switch the mode to the Graphic mode to enhance the color object (e.g., drawing, photo).
	SETTINGS	—	—	To display the OSD Setting menu.
	BACK	—	—	To return the display of the OSD menu to the previous one.

* ✓ : Factory setting

OSD Setting Menu

When the output video is switched to the camera video as per "Switching Video" (P.118) and the [MENU/ENTER] button is pressed, the OSD Main menu appears.

When [SETTINGS] is selected from the OSD Main menu, the OSD Setting menu appears.

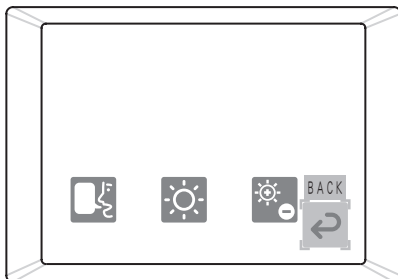

Icon	Name	Condition	Selection item	Function
	BRIGHTNESS	-	AUTO ✓	To vary the degree of auto-following brightness automatically according to the brightness of the object.
			MANUAL	To fix the brightness of the video to any degree.
	BRIGHTNESS SETTING	BRIGHTNESS [AUTO]	NORMAL ✓	To reset the degree of brightness adjustment to the initial settings.
		BRIGHTNESS [MANUAL]	-	To brighten the camera video with the [↑] level bar and darken the camera video with the [↓] level bar.
	WHITE BALANCE	-	AUTO ✓	To set the white balance to the auto following.
			ONE-PUSH	To set the white balance to the fix.
			MANUAL	To set the white balance so that [R-GAIN] and [B-GAIN] can be adjusted manually.
	R-GAIN	WHITE BALANCE [MANUAL]	-	To adjust the red gain of the camera video with the [↑] and [↓] level bars.
	B-GAIN	WHITE BALANCE [MANUAL]	-	To adjust the blue gain of the camera video with the [↑] and [↓] level bars.
	TEXT SETTING	-	TEXT1 ✓	To select the settings in the Text Mode. The larger the number is, the stronger the effect is.
			TEXT2	
			TEXT3	
	EDGE EFFECT	GRAPHICS	3	To enhance the outline of characters, etc. written on the object to sharpen the video. The larger the number is, the stronger the effect is.
			2	
			1 ✓	
			OFF	

* ✓ : Factory setting

Icon	Name	Condition	Selection item	Function
	GAMMA	GRAPHICS	HIGH	To select the preferable gray scale of the video.
			NORMAL ✓	
			LOW	
	COLOR/B&W	-	COLOR ✓	To select the camera video from between [COLOR] and [B&W]. Selecting [B&W] when the material is B&W document will facilitate the visualization of the video.
			B&W	
	POSI/NEGA	-	POSI ✓	To switch the Posi/Nega inversion of the camera video.
			NEGA	
	IMAGE ROTATION	-	ON	To rotate the camera image by 180°.
			OFF ✓	To cancel the camera image rotation by 180°.
	RESOLUTION	-	SXGA ✓	To switch the resolution of the DVI and analog RGB output to 1280x1024.
			XGA	To switch the resolution of the DVI and analog RGB output to 1024x768.
			HD	To switch the resolution of the DVI and analog RGB output to 1280x720.
	FLICKERLESS	-	60Hz	To lower the fluorescent lamp flicker due to power frequency.
			50Hz	
	USB MODE	-	MASS STORAGE	To transfer the data on the SD card set in this Camera to the USB-connected PC.
			APPLICATION ✓	To control this Camera from the USB-connected PC.
	GUIDE	-	ON ✓	To display the operational status of this Camera and the explanation of a specific icon on the screen.
			OFF	To cancel the display of the icon explanation
	CALL	-	FACTORY SETTING	[Yes]: To call up the factory settings of this Camera (Refer to * below. This is not applicable to the flickerless or language setting.) [No]: To cancel the call-up of the factory settings.
	LANGUAGE	-	JAPANESE	To set the display language of the OSD menu to Japanese.
			ENGLISH	To set the display language of the OSD menu to English.
	BACK	-	-	To return the display of the OSD menu to the previous one.

* ✓ : Factory setting

* The last settings of the resolution, flickerless, USB mode and language are maintained.









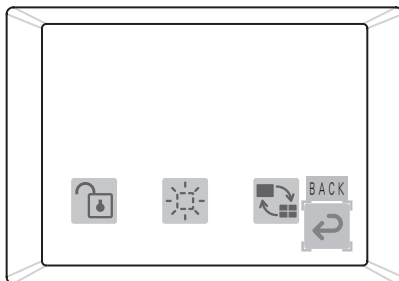

* The factory settings of the flickerless and language vary depending on the place where this Camera is used.

OSD SD Single Menu

When the output video is switched to the SD mode as per "Switching Video" (P.118) and the [MENU/ENTER] button is pressed, the OSD SD Single menu appears.

* Select [ DISPLAY] and set to [SINGLE].



Icon	Name	Condition	Selection item	Function
	HIDE MENU	—	—	To hide the OSD SD Single menu icon. When any of the [   ] buttons or [MENU/ENTER] button on the front operating panel or wireless remote control or the [] button on the wireless remote control is pressed, the OSD SD Single menu icon appears.
	DISPLAY	—	SINGLE	To display the image saved on the SD card in the unsplit status [SINGLE].
			3x3 ✓	To display the image saved on the SD card in the split status [3x3].
			4x4	To display the image saved on the SD card in the split status [4x4].
	DELETE	—	[CURRENT]	[Yes]: To delete the displayed image. [No]: To leave the displayed image undeleted. If the image is locked, the image cannot be deleted.
			[ALL]	[Yes]: To delete all images. [No]: To leave all images undeleted. When the image is locked, the image cannot be deleted.
	LOCK	—	[CURRENT]	[Yes]: To lock the image to set the image protected from deletion. [No]: To leave the image unlocked. When the image is locked, it is also possible to display only the locked image in the slide show. This function is used for selecting images to be displayed in the slide show.
			[ALL]	To lock all images saved on the SD card.
	UNLOCK	—	[CURRENT]	[Yes]: To cancel the lock on the displayed image. [No]: To leave the displayed image locked.
			[ALL]	[Yes]: To cancel the lock on all images saved on the SD card. [No]: To leave all images locked.
	BACK	—	—	To return the display of the OSD menu to the previous one.





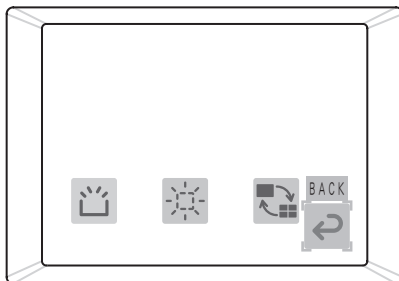

* ✓ : Factory setting

OSD SD Split screen Menu

When the output video is switched to the SD mode as per "Switching Video" (P.118) and the [MENU/ENTER] button is pressed, the OSD SD Split screen menu appears.

* Select [ DISPLAY] and set to [3x3] or [4x4].



Icon	Name	Condition	Selection item	Function
	HIDE MENU	—	—	To hide the OSD SD Split screen menu icon. When any of the [▲▼◀▶] buttons or [MENU/ENTER] button on the front operating panel or the wireless remote control or the [] button on the wireless remote control is pressed, the OSD SD Split screen menu icon appears.
	DISPLAY	—	SINGLE	To display the image saved on the SD card in the unsplit status [SINGLE].
			3x3 ✓	To display the image saved on the SD card in the split status [3x3].
			4x4	To display the image saved on the SD card in the split status [4x4].
	START SLIDE SHOW	—	—	To start the slide show.
	SLIDE SHOW SETTING	—	—	To display the OSD Slide Show Setting menu.
	FORMAT MEDIA	—	—	[Yes]: To format (initialize) the SD card. Formatting will clear all data on the SD card. Before starting the formatting, be sure to confirm that you are sure the data may be cleared.
	BACK	—	—	To return the display of the OSD menu to the previous one.

* ✓ : Factory setting

OSD SD Slide Show Setting Menu

When the output video is switched to the SD mode as per "Switching Video" (P.118) and the [MENU/ENTER] button is pressed, the OSD SD split screen menu appears.

When [SLIDE SHOW SETTING] is selected from the OSD SD split screen menu, the OSD SD Slide Show Setting menu appears.

* Select [DISPLAY] and set to [3x3] or [4x4].

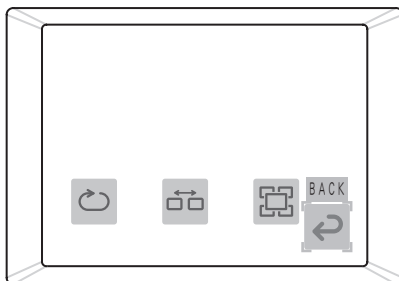

Icon	Name	Condition	Selection item	Function
	INTERVAL	—	3 SEC ✓	To set the time until the next image is displayed in the slide show.
			5 SEC	
			10 SEC	
			15 SEC	
			30 SEC	
	EFFECT	—	LEFT TO RIGHT	To set the image slide direction in the slide show.
			LT TO RB	
			RT TO LB	
			NONE ✓	To set no visual effect in the slide show.
	SELECT	—	ALL ✓	To set the object to be displayed in the slide show to all displayable image saved on the SD card.
			LOCKED ONLY	To set the object to be displayed in the slide show only to the locked images saved on the SD card.
	ORDER	—	FORWARD ✓	To perform the slide show in the ascending order of the serial Nos. of the file names.
			BACK WARD	To perform the slide show in the descending order of the serial Nos. of the file names.
	REPEAT	—	ON	To perform the slide show repeatedly.
			OFF ✓	To finish the slide show after performing it only once.
	BACK	—	—	To return the display of the OSD menu to the previous one.

* ✓ : Factory setting

Receiving by Wireless Remote Control

Point the transmission unit of the wireless remote control at the sensor unit located on the front side of the Camera main unit, press the operation button of the intended operation and operate the Camera main unit accordingly.

Receivable Range

Distance: Within approx. 7m from the front face of the wireless remote control sensor unit.

Angle: Within 30° in upward, downward, rightward and leftward from the wireless remote control sensor unit.

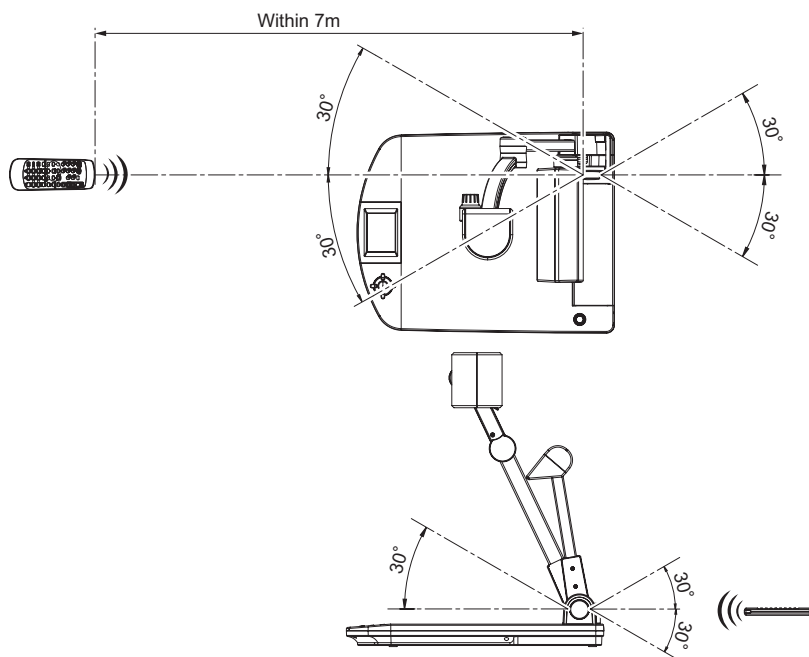

Note:

- The receivable range may be shortened or narrowed and the laser beam from the wireless remote control may not be sensed depending on the surrounding circumstances (e.g., sun light, position adjacent to inverter fluorescent lamp). In this case, relocate the receiving side or shield the sun light or fluorescent lamp.
- When setting the batteries, remove the battery case cover by pushing the [▼] mark in the arrow direction on the back side of the wireless remote control, and set 2 pieces of AAA batteries in the case.
- Direct good care to the polarity (directions of +/-) of the battery.
- Be sure to use AAA batteries.
- Replace the batteries once every year.
- The attached batteries are only for initial operation check. Their effective duration of service is not guaranteed.

How to Attach Wireless Remote Control Holder

Attach the supplied wireless remote control holder to the rear side of the stage as follows:

1. Insert the tab of the wireless remote control holder into the slit of the rear side of the stage for latching.

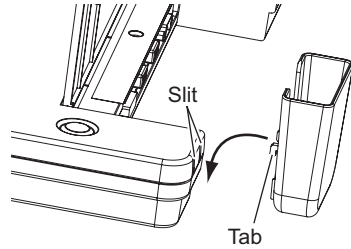

2. Lower the wireless remote control holder.

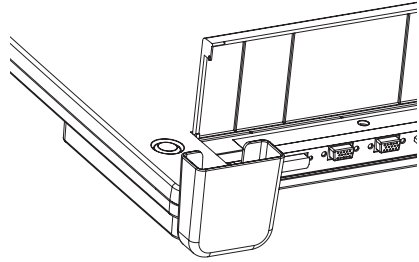

3. Set the wireless remote control in the holder.

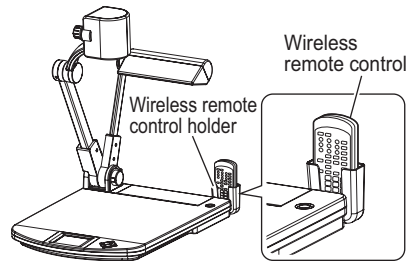

How to Set up the Camera

- 1.** Lift the camera column.
Simultaneously, the lamp column rises.

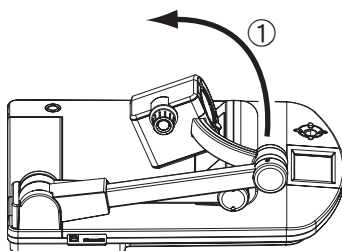

- 2.** Turn the camera head.

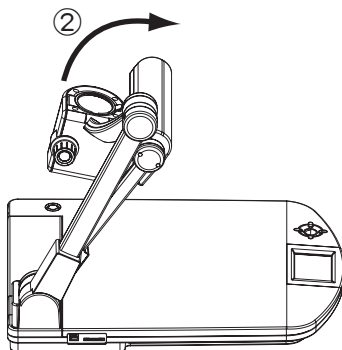

- 3.** Move the lamp column and the lamp head to an appropriate position.

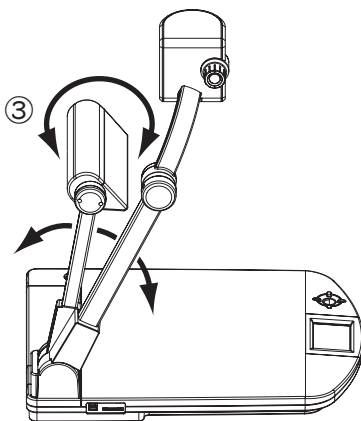

4. Connect the video cable to the Camera, and plug the DC plug of the AC adapter into the 12VDC IN terminal (power socket).

Ref. **Connecting AC Adapter and Video Cable (P.107)**

5. Turn ON the power supply to the Camera.

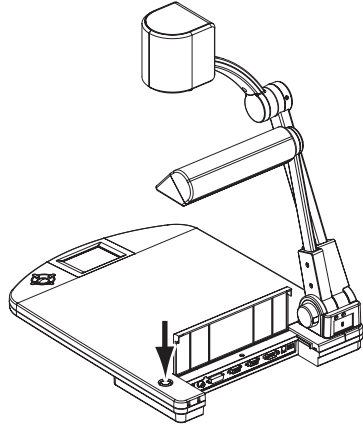

Note:

- When using the Camera, adjust the lamp column and the lamp head to the easy-to-work position beforehand.
- When lifting or lowering the camera column and the lamp column, be careful not to have your finger or the like pinched.
- When shooting a transparent film, place a white paper under the film. (This is applicable only to the black-body type of the North American specifications.)

Connecting AC Adapter and Video Cable

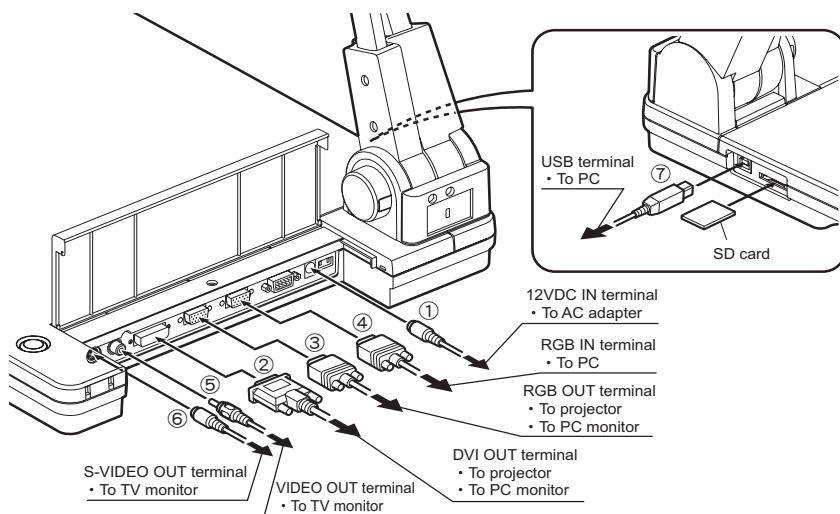

Note:

- To protect the Camera and the peripheral units to be connected to the Camera, be sure to turn OFF the power supply to all peripheral units to be connected and unplug the power plug from the outlet beforehand.
- When plugging/unplugging the power plug, the AC adapter and the video cable, hold on to their cable connector plugs.
- For the information of how to switch the output video, refer to "Switching Video" (P.118).
- For the information of how to switch the video output system, refer to "DIP Switch" (P.92).

① For Connecting AC Adapter

1. Connect the supplied power cord to the AC adapter beforehand.
2. Plug the DC plug of the AC adapter into the 12VDC IN terminal of the rear panel.
3. Plug the AC adapter into the outlet.

② For Connecting to device having DVI Input Terminal

1. Connect the DVI cable to the DVI OUT terminal of the rear panel.
2. Connect the DVI cable to the DVI IN terminal of the unit having a DVI input terminal.

③ For Connecting to device having Analog RGB Input Terminal

1. Connect the analog RGB cable to the RGB OUT terminal of the rear panel.
2. Connect the analog RGB cable to the RGB IN terminal of the unit having an analog RGB input terminal.

Note:

- The display position of the screen may be displaced from the center of the screen. In this case, adjust the horizontal and vertical positions manually from the connected device.
- Vertical stripes may appear on the LCD projector or the monitor screen. In this case, adjust the dot clock manually from the connected device. The vertical stripes may be mitigated.
- When a laptop having an external output mode switching function is used, switch the video output of the Camera to [PC] and then set the laptop to the external output mode.

④ For Connecting to device having Analog RGB Output Terminal

- 1.** Connect the analog RGB cable to the RGB IN terminal of the rear panel.
 - 2.** Connect the analog RGB cable to the RGB OUT terminal of the device having an analog RGB output terminal.
- Analog RGB input terminal RGB IN specifications of the Camera.

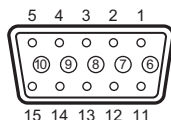
Signal allocation

D-SUB 15P shrink terminal (female)

Video signal	Analog 0.7V (p-p) 75Ω terminated
Horizontal synchronization signal	TTL level (Positive/negative polarity)
Vertical synchronization signal	TTL level (Positive/negative polarity)

Terminal arrangement

Pin No.	Name	Pin No.	Name	Pin No.	Name
1	Video signal (Red)	6	GND (Red)	11	GND
2	Video signal (Green)	7	GND (Green)	12	N.C
3	Video signal (Blue)	8	GND (Blue)	13	Horizontal synchronization signal
4	N.C	9	N.C	14	Vertical synchronization signal
5	GND	10	GND	15	N.C

⑤ For Connecting to device having Composite Vide Input Terminal

- 1.** Plug the video cable with RCA pin plug into the VIDEO OUT terminal of the rear panel.
- 2.** Plug the video cable with RCA pin plug into the VIDEO IN terminal of the device having a composite VIDEO input terminal.

⑥ For Connecting to device having S-Video Input Terminal

1. Connect the S-video cable to the S-VIDEO OUT terminal of the rear panel.

Note:

- If the unit to be used is of Y/C-separate connector type, a conversion adapter should be used.

2. Connect the S-video cable to the S-VIDEO IN terminal of the device having an S-video input terminal.

⑦ For Connecting to PC with USB Cable

1. Connect the USB cable to the USB terminal of the side panel.
2. Connect the USB cable to the USB terminal of the PC.

Note:

- The USB cable should preferably be of USB 2.0 complied.
- If the USB cable is connected without turning OFF the power supply to the Camera and the PC beforehand, the PC may not recognize the USB correctly.
- Under the influence of the USB environment or peripheral units used by the PC, image transfer may be disturbed.
- The connection of the AC adapter and video cable as per above is not always guaranteed in any environment.

How to Store The Camera

1. Turn OFF the power supply to the Camera.

Note:

- When storing the Camera, turn OFF the power supply to the Camera beforehand.

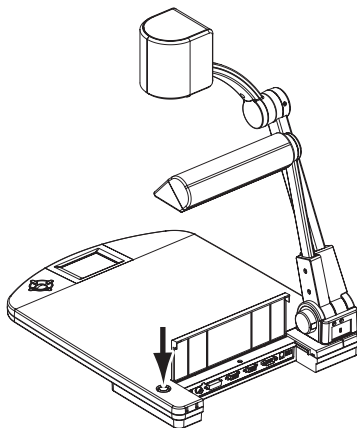

2. Remove the DC plug of the AC adapter and the video cable from the Camera.

Ref. **Connecting of AC Adapter and Video Cable (P.107)**

3. Turn the lamp head and the lamp column and fold them on the stage.

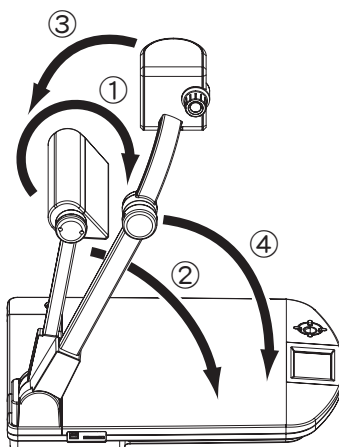

4. Turn the camera head and the camera column and fold them.

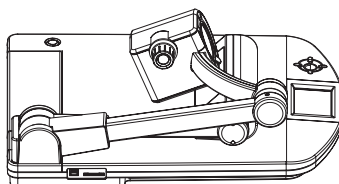

OPERATION OF THIS CAMERA

Turning ON/OFF Power Supply

For Turning ON

Note:

- When connecting the Camera to other device, turn OFF the power supply to all device beforehand.

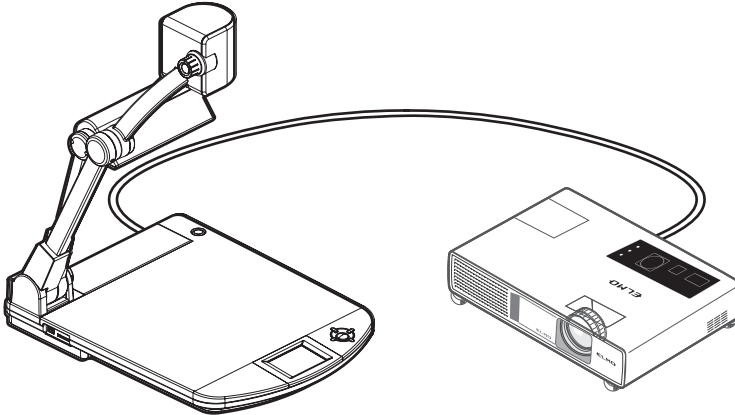

1. Plug the DC plug of the supplied AC adapter into the 12VDC IN terminal of the rear panel, and plug the AC adapter into the outlet.

Ref. **How to Set up the Camera (P.105)**

Connecting AC Adapter and Video Cable (P.107)

2. When the power supply to the Camera is OFF, press the [⏻ MAIN SWITCH] switch.

The power supply to the Camera is turned ON.

For Turning OFF

1. Stop all operations, and press the [⏻ MAIN SWITCH] switch.

The power supply to the Camera is turned OFF.

Note:

- Do not turn ON/OFF the power supply to the Camera by plugging/unplugging the AC adapter or power plug.
- Even if instantaneous power failure occurs, the main unit of the Camera may restart. In this case, turn OFF the power supply to the Camera once, wait for the recovery of the supply power, and turn ON the power supply. If power failure is probable, it is advisable to use an UPS (uninterruptible power supply).

Basic Operation of OSD

The following procedures show how to operate the buttons for setting and operating the Camera from the OSD. For the details of the setting and operation, refer to OSD (On Screen Display) (P.97).

For Selecting and Deciding Icon

1. Go to the icon to be operated or set by using the [▲▼◀▶] buttons on the front operating panel or wireless remote control.
2. Fix the selected operation or setting by using the [MENU/ENTER] button on the front operating panel or wireless remote control.

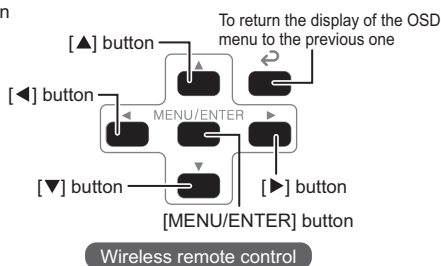
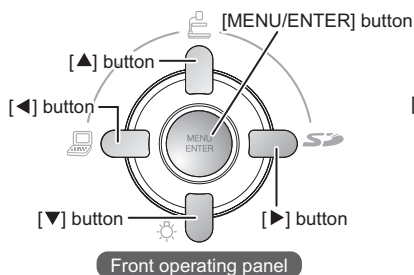

For Selecting and Deciding Item

1. Move the cursor to any item for selection by using the [▲▼] buttons on the front operating panel or wireless remote control.
2. Fix the selected item by using the [MENU/ENTER] button on the front operating panel or wireless remote control.

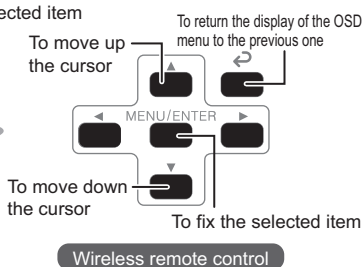
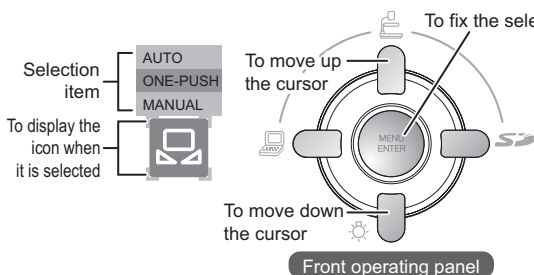

For Adjusting Level Bar

1. Adjust the set value by using the [\blacktriangle \blacktriangledown] buttons on the front operating panel or wireless remote control.
2. Fix the set value by using the [MENU/ENTER] button on the front operating panel or wireless remote control.

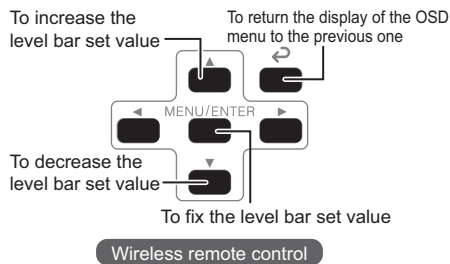
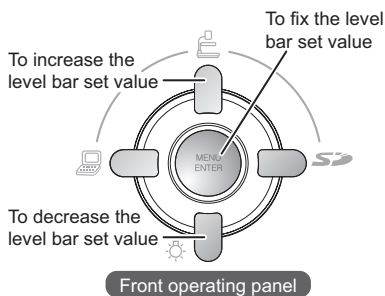
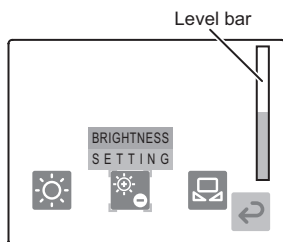



Turning ON/OFF Lamp



When used in the case of insufficient brightness of the material surface or shooting a 3D object, the lamp helps obtaining sharp video.

1. When the OSD menu is in display, hide the OSD menu by operating the front operating panel or repeatedly pressing the [BACK] button on the wireless remote control.

When [ HIDE MENU] is ON, cancel it.

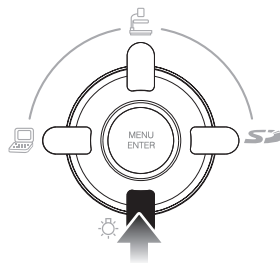
2. Press the [] button on the front operating panel or the [] button on the wireless remote control.



3. Each time the [] button on the front operating panel or the [] button on the wireless remote control is pressed, the material lamp repeats turning ON and OFF.

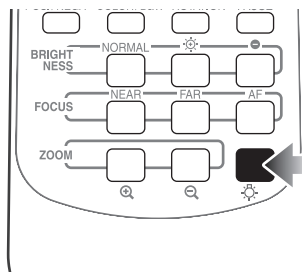

Note:

- Do not look into the lamp part. It may damage your eyes.
- The brightness of the lamp (LED) deteriorates as the operating time passes.
- The lamp may become high-temperature during lighting. Do not touch the lamp part.

For Adjusting Illumination Position

1. Adjust the lamp column so that the lamp head cannot be shot on the screen.
2. Adjust the angle of the lamp head while watching the screen so that the illumination can be provided uniformly over the stage.

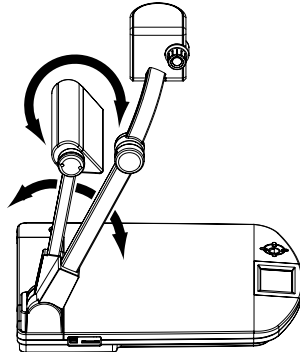
**Note:**

- Depending on the illumination position, the shadow of the camera column may appear on the screen.

Adjusting Zoom

1. Turn the zoom dial.

The display range can be adjusted.

- WIDE-ANGLE (ZOOM-OUT (⊖)): To image the object smaller.
- TELESCOPIC (ZOOM-IN (⊕)): To image the object larger.

When the wireless remote control is used, press the [⊖] button for WIDE-ANGLE and the [⊕] button for TELESCOPIC.

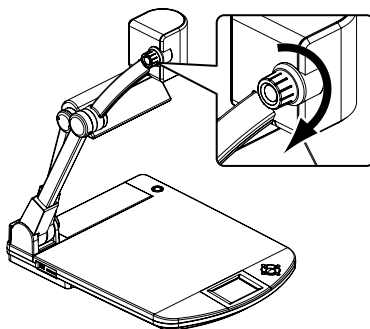

2. Leave the dial in the turned status.

The zoom speed can be changed in 2 steps.

When the wireless remote control is used, hold down the [⊖] button or the [⊕] button, and the zoom speed will be changed in 2 steps.

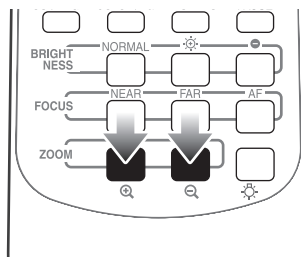



Note:



- The zoom magnification is available up to 16x for the optical zoom and up to 4x for the digital zoom.
- When the digital zoom is in operation, the image quality is degraded.
- Within the digital zoom range, the zoom speed stays constant.
- When the digital zoom is in operation, the screen can be scrolled by using the [▲▼◀▶] buttons on the wireless remote control.
- When the video is in transmission through the USB cable, the digital zoom speed is slow.
- In the SD mode, the SD image can be zoomed (zoom-in, zoom-out) digitally.
- When the power supply is turned OFF, the zoom settings are reset to the factory settings.



Switching Video

1. When the OSD menu is in display, hide the OSD menu by operating the front operating panel or repeatedly pressing the [BACK] button on the wireless remote control.

When [ HIDE MENU] is ON, cancel it.

2. Press the [  ] buttons on the front operating panel to select the video switching to any video.

- [] button:
To switch the output video to the camera video
- [] button:
To switch the output video to the RGB IN video
- [] button:
To switch the mode of the output video to the SD mode

When the wireless remote control is used, press the [] button, the [] button and the [] button.

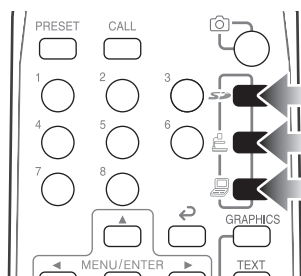
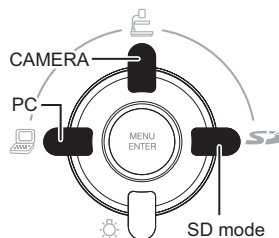

Note:

- When the PC or other device is connected to the analog RGB input terminal [RGB IN], the output video from the analog RGB output terminal [RGB OUT] can be switched without any trouble to exchange the connection cable.
- From the video output terminal [VIDEO OUT] and the DVI output terminal [DVI OUT], only the camera video is output and the [RGB IN] video cannot be output.
- If the mode is switched to the SD mode when the SD card is not set in the Camera, the screen is blacked out.
- If the RGB input terminal [RGB IN] is not connected to the PC or other unit, nothing appears on the screen.
- When [GUIDE] on the OSD Setting menu is set to [ON], the settings appear on the screen.
- When a laptop having an external output mode switching function is used, switch the video output of this Camera to [PC] and then set the notebook PC to the external output mode.

Adjusting Focus

The focus of the object can be adjusted.

The Camera is of one-shot auto focus type. Once the object is brought into focus, the auto focus operation is cancelled and the then focus position is maintained.

The manual focus is used to adjust the focus to any part of the object (e.g., 3D material).

For Auto Focus

1. Press the [AF] button on the Camera.

The object is brought into focus automatically. When the wireless remote control is used, press the [AF] button.

Note:

- When the [NEAR] button or [FAR] button on the wireless remote control is pressed during the auto focus operation, the auto focus operation is cancelled.

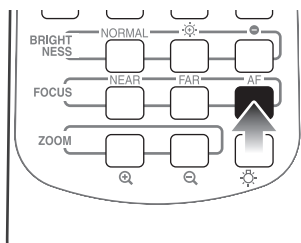
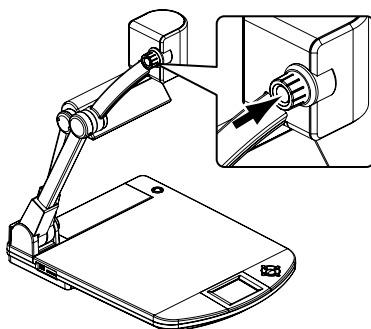

For Manual Focus

1. Press the [NEAR] button or [FAR] button on the wireless remote control.

The focus can be adjusted manually.

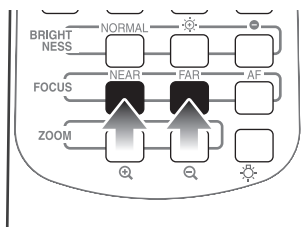

Note:

Focal range:

- With the close-up lens

TELE side (Telescopic): 250 - 410mm (9.8 - 16.1 in) from the close-up lens

WIDE side (Wide-angle): 85 - 410mm (3.3 - 16.1 in) from the close-up lens

- Without the close-up lens

TELE side (Telescopic): 500mm - ∞ (19.7 in - ∞) from the zoom lens

WIDE side (Wide-angle): 100mm - ∞ (3.9 in - ∞) from the zoom lens

- Objects as follows may not be brought into focus in the auto focus. In this case, use the manual focus buttons [NEAR] and [FAR] on the wireless remote control.

Objects with a little difference between brightness and darkness (contrast)

Objects with repeated fine patterns (e.g., crossbars, lattices)

Objects that are glittering, reflecting intensive light or bright

Objects with bright background or excessive contrast

Objects whose images are entirely dark

Objects that are located near and far away



Objects that are moving





- The settings can be displayed on the screen by selecting [GUIDE] → [ON] from the OSD Setting menu.

Adjusting Brightness

The brightness of video can be adjusted by adjusting the lens iris.





For Adjusting Brightness Automatically

1. When the OSD menu is in display, hide the OSD menu by operating the front operating panel or repeatedly pressing the [BACK] button on the wireless remote control.
When [ HIDE MENU] is ON, cancel it.
2. Press the [] button on the front operating panel or the [] button on the wireless remote control to switch the output video to the camera video.
3. Press the [MENU/ENTER] button on the front operating panel or wireless remote control.
The OSD Main menu appears.

4. Select [ SETTINGS] from the OSD Main menu by using the [] buttons on the front operating panel or wireless remote control.
The OSD Setting menu appears.







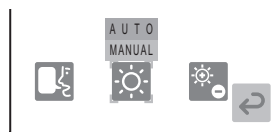

OSD Main Menu

5. Select [ BRIGHTNESS] → [AUTO] from the OSD Setting menu by using the [] buttons on the front operating panel or wireless remote control.





OSD Setting Menu

6. Select [ BRIGHTNESS SETTING] → [ADJUST] from the OSD Setting menu by using the [] buttons on the front operating panel or wireless remote control, and set the level bar by using the [] buttons.

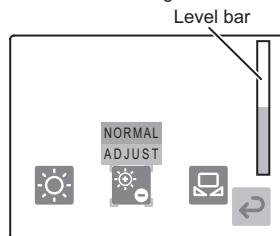
The degree of brightness for auto following can be adjusted.



OSD Setting Menu





















Alternatively, by pressing the [] and [] buttons in the [BRIGHTNESS] item on the wireless remote control, the degree of brightness can be adjusted.



Note:

- When [BRIGHTNESS SETTING] → [NORMAL] are selected from the OSD Setting menu, the current settings are reset to the initial settings. Alternatively, by selecting [NORMAL] in the [BRIGHTNESS] item on the wireless remote control, the current settings can be reset to the initial settings.

For Adjusting Brightness Manually

- When the OSD menu is in display, hide the OSD menu by operating the front operating panel or repeatedly pressing the [BACK] button on the wireless remote control.
When [ HIDE MENU] is ON, cancel it.
- Press the [] button on the front operating panel or the [] button on the wireless remote control to switch the output video to the camera video.
- Press the [MENU/ENTER] button on the front operating panel or wireless remote control.
The OSD Main menu appears.
- Select [ SETTINGS] from the OSD Main menu by using the [   ] buttons on the front operating panel or wireless remote control.
The OSD Setting menu appears.
- Select [ BRIGHTNESS] → [MANUAL] from the OSD Setting menu by using the [   ] buttons on the front operating panel or wireless remote control.
- Select [ BRIGHTNESS SETTING] from the OSD Setting menu by using the [   ] buttons on the front operating panel or wireless remote control, and set the brightness by using the [ ] buttons so that it can be fixed to an intended level.



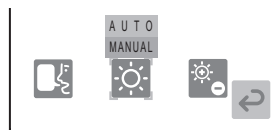

OSD Main Menu

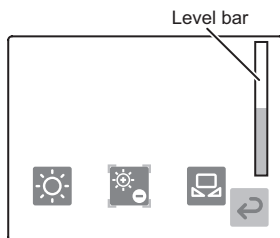

OSD Setting Menu



OSD Setting Menu

Alternatively, by pressing the [] and [] buttons in the [BRIGHTNESS] item on the wireless remote control, the degree of brightness can be adjusted.











Note:

- The brightness has been set to [AUTO] in the initial settings.
- When the manual brightness adjustment is used, the brightness is fixed and the variation in the brightness of object is not followed.
- When the manual brightness adjustment is used, even if the [NORMAL] button on the wireless remote control is pressed, this button does not work.
- The settings can be displayed on the screen by selecting [GUIDE] → [ON] from the OSD Setting menu.

Adjusting White Balance

The intensity of the white color of video can be adjusted.



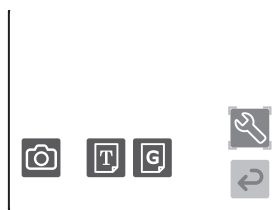

1. When the OSD menu is in display, hide the OSD menu by operating the front operating panel or repeatedly pressing the [BACK] button on the wireless remote control.
When [ HIDE MENU] is ON, cancel it.
2. Press the [] button on the front operating panel or the [] button on the wireless remote control to switch the output video to the camera video.
3. Press the [MENU/ENTER] button on the front operating panel or wireless remote control.
The OSD Main menu appears.
4. Select [ SETTINGS] from the OSD Main menu by using the [   ] buttons on the front operating panel or wireless remote control.
The OSD Setting menu appears.

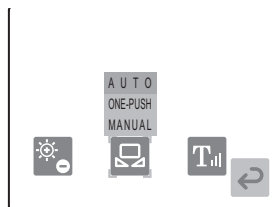

OSD Main Menu



OSD Setting Menu

5. Select [ WHITE BALANCE] from the OSD Setting menu by using the [   ] buttons on the front operating panel or wireless remote control, and select an intended item.

[AUTO]: To set the white balance to the auto following.

Used for adjusting the intensity of the white color of video automatically depending on the material condition.

[ONE-PUSH]: To set the white balance to the fix.

Used in case that the color balance of video is lost due to the material condition.

[MANUAL]: To set the white balance so that [R-GAIN] and [B-GAIN] can be adjusted manually.

For details, refer to For Adjusting R-GAIN and B-GAIN Manually (P.124).



Note:





- The color temperature range that can be followed automatically is approx. 3000 - 8000K.
- Depending on the object or light source, precise auto adjustment may not be achieved. In this case, shoot a white object, adjust the intensity of the white color automatically, select [WHITE BALANCE] → [ONE-PUSH] from the OSD Setting menu.

For Adjusting R-GAIN and B-GAIN Manually

1. When the OSD menu is in display, hide the OSD menu by operating the front operating panel or repeatedly pressing the [BACK] button on the wireless remote control.

When [ HIDE MENU] is ON, cancel it.



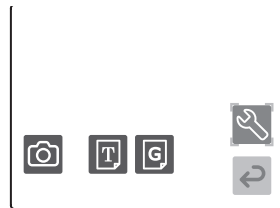

2. Press the [] button on the front operating panel or the [] button on the wireless remote control to switch the output video to the camera video.
3. Press the [MENU/ENTER] button on the front operating panel or wireless remote control.
The OSD Main menu appears.

4. Select [ SETTINGS] from the OSD Main menu by using the [   ] buttons on the front operating panel or wireless remote control.

The OSD Setting menu appears.







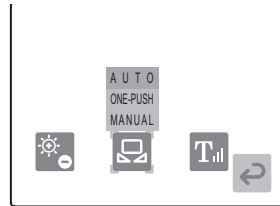

OSD Main Menu

5. Select [ WHITE BALANCE] → [MANUAL] from the OSD Setting menu by using the [   ] buttons on the front operating panel or wireless remote control.



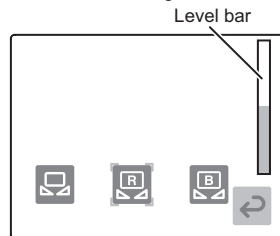

OSD Setting Menu

6. Select [ R-GAIN] or [ B-GAIN] from the OSD Setting menu by using the [   ] buttons on the front operating panel or wireless remote control.



OSD Setting Menu

7. Set the level bar by using the [ ] buttons on the front operating panel or wireless remote control, and adjust the intensity of the red color or blue color.

Presetting and Calling

The status of the Camera can be saved (i.e., presetting) and called up. Up to 8 different statuses can be saved out of the following statuses:

- Current zoom field angle (Optical zoom range)
- Brightness level
- White Balance status
- R-Gain (When [WHITE BALANCE] → [MANUAL] are selected)
- B-Gain (When [WHITE BALANCE] → [MANUAL] are selected)
- Edge effect settings (When [GRAPHICS] is selected)
- Gamma value settings (When [GRAPHICS] is selected)
- ON/OFF of the lamp
- Settings of Color/B&W switching
- Video Rotation positions
- TEXT/GRAPHICS settings
- POSI/NEGA settings

Note:

- The status saved in each memory No. can be retained even if the power supply to this Camera is turned OFF.
- The Video Rotation positions cannot be saved in the Power ON settings (Memory No. [8] of the wireless remote control).
- The current zoom field angle when the digital zoom is in operation cannot be saved. If the saving of the current zoom field angle when the digital zoom is in operation is attempted, the optical zoom range is set to the maximum extent of the TELESCOPIC [Q] side.
- To reset the settings as of the turning ON the power supply to the factory settings, save the factory settings in Memory No. [8].

For Presetting

1. Press the [PRESET] button on the wireless remote control.
2. When any memory No. button on the wireless remote control is pressed within 4 sec, the current status of the unit can be saved in the selected memory No.

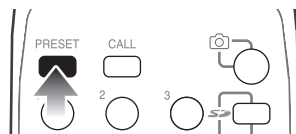

Note:

- When the status is saved in Memory No. [8], the status set as of the turning ON the power supply is called up automatically.

For Calling up

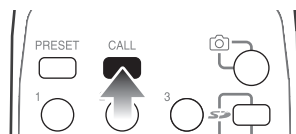

1. Press the [CALL] button on the wireless remote control.
2. When any memory No. button on the wireless remote control is pressed within 4 sec, the status saved in the selected memory No. are called up.



When [CALL] → [FACTORY SETTING] → [Yes] are selected from the OSD Setting menu, the functions that can be set in "Presetting and Calling" can be reset to the factory settings.



Using SD Card (Option)

For Inserting SD Card

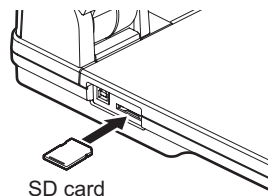
1. When the OSD menu is in display, hide the OSD menu by operating the front operating panel or repeatedly pressing the [BACK] button on the wireless remote control.
When [ HIDE MENU] is ON, cancel it.
2. Press the [] button on the front operating panel or the [] button on the wireless remote control to switch the output video to the camera video.
3. Insert the SD card into the SD card slot of the side panel.



For Removing SD Card

1. When the OSD menu is in display, hide the OSD menu by operating the front operating panel or repeatedly pressing the [BACK] button on the wireless remote control.
When [ HIDE MENU] is ON, cancel it.
2. Press the [] button on the front operating panel or the [] button on the wireless remote control to switch the output video to the camera video.
3. Push in the SD card lightly with your finger.
The SD card can be removed.

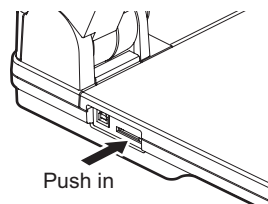

Note:

- When inserting the SD card into the SD card slot, confirm that the output video has been switched to the camera video beforehand. If not, the contents of the SD card may be destroyed or the SD card may be broken.
- Since the SD card is made up of components susceptible to static electricity, the SD card may have false operation or its contents may be destroyed under the influence of static electricity. Therefore, treat the SD card with utmost care not to be affected by static electricity.
- All image data that can be displayed on the Camera is only the image data saved in the Camera and that converted by using the bundled software.
- If the display of any image data in any undisplayable form is attempted, the output screen is blackened or grayed.
- If the video is switched to the SD card image without inserting the SD card in the SD card slot, the output screen is blackened and the warning of "NO CARD" is displayed there.
- After using the SD card, do not leave it inserted but remove it and keep it safe.
- It is recommendable that the SD card to be used should be Panasonic 256MB or 512MB. The resolutions available to the images to be saved are 1280x1024 (SXGA output), 1280x720 (HD 720P output) and 1280x960 (XGA output).
- The Camera is capable of controlling up to 2048 images.
- ELMO Co., Ltd. is not liable to any damages and passive damages due to the loss of the data on the SD card.
- In the SD mode, the bundled software cannot be used.
- The Camera is not compatible with SDHC card.

For Saving Images on SD Card

1. When the OSD menu is in display, hide the OSD menu by operating the front operating panel or repeatedly pressing the [BACK] button on the wireless remote control.
When [HIDE MENU] is ON, cancel it.

2. Press the [] button on the front operating panel or the [] button on the wireless remote control to switch the output video to the camera video.

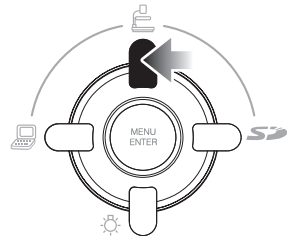

3. Press the [MENU/ENTER] button on the front operating panel or wireless remote control.
The OSD Main menu appears.

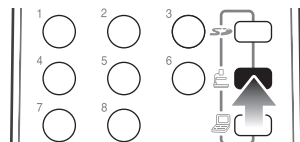

4. Select [CAPTURE] from the OSD Main menu by using the [] buttons on the front operating panel or wireless remote control, or press the [] button on the wireless remote control.

The [] mark lights up on the screen, and saving starts.

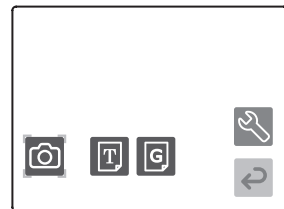

OSD Main Menu

5. The [] mark goes out.
Now, the image saving is completed.

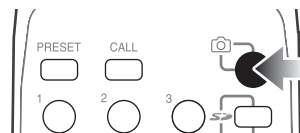

Note:

- Be sure to try shooting and confirm the normal saving of the image beforehand. If the image saving is failed due to some trouble in this Camera or the SD card, ELMO Co., Ltd. is not liable to the compensation for the loss of the image data.
- The [] mark is displayed on the screen only when [GUIDE] has been set to [ON] on the OSD Setting menu.
- If the SD card switch is set to "write protect," the SD card cannot record image data.
- If the SD card memory is full and no longer able to record image data, the [] mark does not light up. In this case, delete unnecessary image data or replace it by a new SD card.
- When the SD card is in read/write operation, do not remove it, or failure may be caused to the SD card.
- If the image saving is attempted when the digital zoom is in operation, the digital zoom is cancelled and current settings are reset to the factory settings and saved.
- The image file cannot record the correct date and time.

For Operation in SD Mode



1. When the OSD menu is in display, hide the OSD menu by operating the front operating panel or repeatedly pressing the [BACK] button on the wireless remote control.

When [ HIDE MENU] is ON, cancel it.

2. Press the [▶] button on the front operating panel or the [▶] button on the wireless remote control to switch the mode to the SD mode.

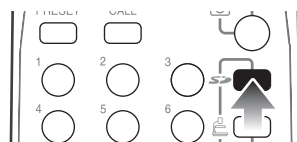
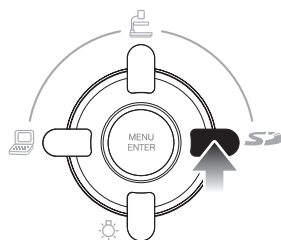
One image saved on the SD card is displayed. [SINGLE]





- Operation of the front operating panel in the SD mode
 - [▲] button: To switch the output video to the camera video
 - [▼] button: To switch the ON/OFF of the lamp
 - [◀] button: To switch the output video to the RGB IN video
 - [▶] button: To display the next image saved on the SD card (Screen Feed Forward)
 - [MENU/ENTER]: To display the OSD SD Single menu or the OSD SD Split screen menu
*The menu appears as per set in [ DISPLAY].
- Operation of the wireless remote control in the SD mode
 - [▲], [◀]: To display the previous image saved on the SD card (Screen Feed Backward)
 - [▼], [▶]: To display the next image saved on the SD card (Screen Feed Forward)
 - [MENU/ENTER]: To display the OSD SD Single menu or the OSD SD Split screen menu
*The menu appears as per set in [ DISPLAY].

For Displaying OSD SD Single Menu

1. When the OSD menu is in display, hide the OSD menu by operating the front operating panel or repeatedly pressing the [BACK] button on the wireless remote control.

When [ HIDE MENU] is ON, cancel it.

2. Press the [] button on the front operating panel or the [] button on the wireless remote control to switch the mode to the SD mode.

One image saved on the SD card is displayed. [SINGLE]

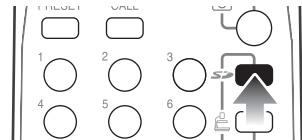
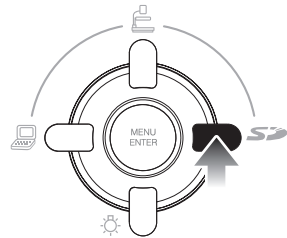





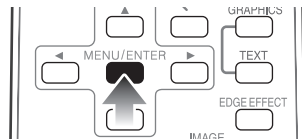
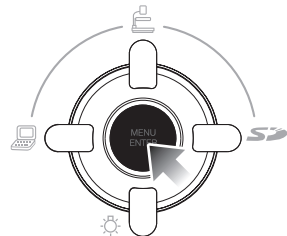

3. Press the [MENU/ENTER] button on the front operating panel or wireless remote control.

When the current settings are default, the OSD SD Split screen menu appears.

When the OSD SD Split screen menu appears, select [ DISPLAY] → [SINGLE].





Note:

- To hide the icon of the OSD SD Single menu, press [ HIDE MENU]. To redisplay the icon, press any of the [] [] [] [] buttons or [MENU/ENTER] button on the front operating panel or wireless remote control or the [ BACK] button on the wireless remote control.

For Displaying OSD SD Split screen Menu

1. When the OSD menu is in display, hide the OSD menu by operating the front operating panel or repeatedly pressing the [BACK] button on the wireless remote control.

When [ HIDE MENU] is ON, cancel it.

2. Press the [] button on the front operating panel or the [] button on the wireless remote control to switch the mode to the SD mode.

One image saved on the SD card is displayed. [SINGLE]

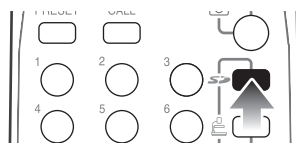
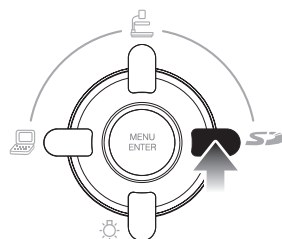

3. Press the [MENU/ENTER] button on the front operating panel.





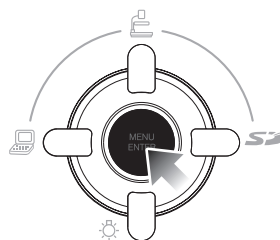

The OSD SD Split screen menu appears.

When the OSD SD Single menu appears, select [ DISPLAY] → [3x3] or [4x4].



OSD SD Thumbnail Menu

Note:

- To hide the icon of the OSD SD Split screen menu, press [ HIDE MENU]. To redisplay the icon, press any of the [   ] buttons or [MENU/ENTER] button on the front operating panel or wireless remote control or the [ BACK] button on the wireless remote control.

For Selecting Images on SD Card from OSD SD Single Menu

1. When the OSD menu is in display, hide the OSD menu by operating the front operating panel or repeatedly pressing the [BACK] button on the wireless remote control.

When [ HIDE MENU] is ON, cancel it.

2. Press the [▶] button on the front operating panel or the [↵] button on the wireless remote control to switch the mode to the SD mode.

One image saved on the SD card is displayed. [SINGLE]

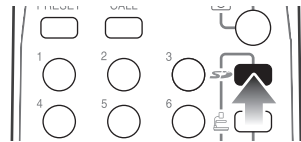
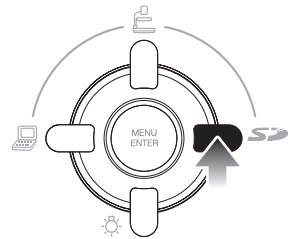

3. Press the [MENU/ENTER] button on the front operating panel.

The menu appears as per set in [ DISPLAY].

When the OSD SD Split screen menu appears, select [ DISPLAY] → [SINGLE].

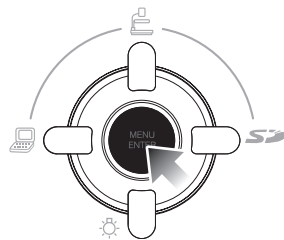

4. When the cursor is on any icon other than the [↩ BACK] icon, press the [▲] button on the front operating panel. The image saved on the SD card can be selected.

Basic operation for image selection:

- [▶] button : To display the next image saved on the SD card (Screen Feed Forward)
- [◀], [▲] button: To display the previous image saved on the SD card (Screen Feed Backward)
- [▼] button : To return to the selection of the OSD SD Single menu icon.
- [MENU/ENTER] button: To switch the split screen display to [3x3] or [4x4] and display the OSD SD Split screen menu.

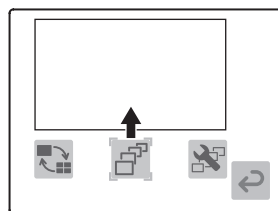
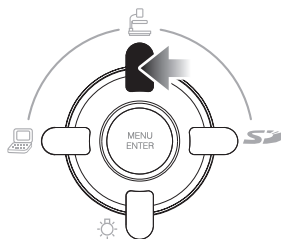

OSD SD Single Menu

For Selecting Images on SD Card from OSD SD Split screen Menu

1. When the OSD menu is in display, hide the OSD menu by operating the front operating panel or repeatedly pressing the [BACK] button on the wireless remote control.

When [ HIDE MENU] is ON, cancel it.

2. Press the [▶] button on the front operating panel or the [] button on the wireless remote control to switch the mode to the SD mode.

One image saved on the SD card is displayed.

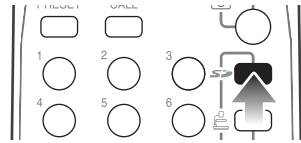
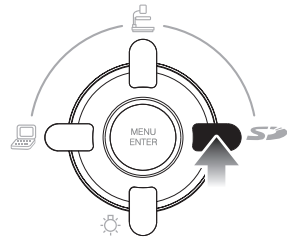

3. Press the [MENU/ENTER] button on the front operating panel.

The menu appears as per set in [ DISPLAY].

When the OSD SD Single menu appears, select [ DISPLAY] → [3x3] or [4x4].

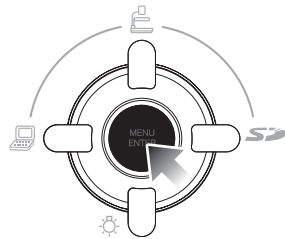

4. When the cursor is on any icon other than the [↶ BACK] icon, press the [▲] button on the front operating panel. The image saved on the SD card can be selected.

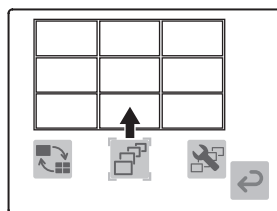
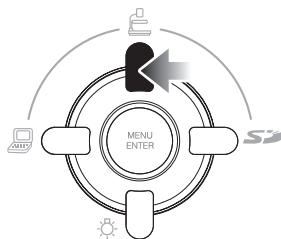

OSD SD Thumbnail Menu

Basic operation for image selection:

[▲▼◀▶] buttons: To select the image saved on the SD card

[MENU/ENTER] button: To display the selected image and switch the menu to the OSD SD Single menu.

When the cursor is on the top image area and the [▲] button is pressed, the previous page is displayed.



When the cursor is on the top-left image area and the [◀] button is pressed, the previous page is displayed.

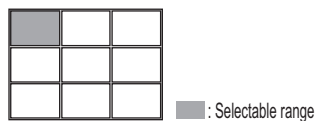

When the cursor is on the bottom-right image area and the [▶] button is pressed, the next page is displayed.

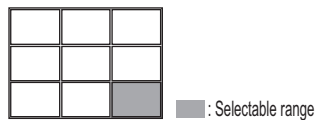

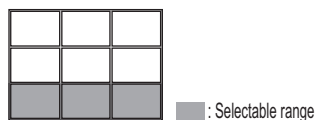

When the cursor is on the bottom image area and the [▼] button is pressed, the selection of the OSD SD Split screen menu icon is resumed.



For Performing Slide Show

1. When the OSD menu is in display, hide the OSD menu by operating the front operating panel or repeatedly pressing the [BACK] button on the wireless remote control.

When [ HIDE MENU] is ON, cancel it.

2. Press the [] button on the front operating panel or the [] button on the wireless remote control to switch the mode to the SD mode.

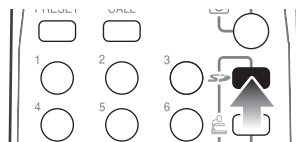
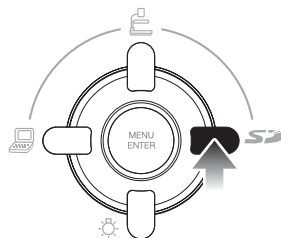

One image saved on the SD card is displayed. [SINGLE]



3. Press the [MENU/ENTER] button on the front operating panel or wireless remote control.

The OSD SD Split screen menu appears.

When the OSD SD Single menu appears, select [ DISPLAY] → [3x3] or [4x4].





4. Select [ START SLIDE SHOW] by using the [   ] buttons on the front operating panel or wireless remote control.

The slide show starts.

To set the slide show, go to the OSD SD Slide Show Setting menu by pressing [ SLIDE SHOW SETTING].



OSD SD Split screen Menu



5. Press any of the [   ] buttons or [MENU/ENTER] button on the front operating panel or wireless remote control or the [ BACK] button on the wireless remote control.

The slide show stops.

For Deleting Image from SD Card

1. When the OSD menu is in display, hide the OSD menu by operating the front operating panel or repeatedly pressing the [BACK] button on the wireless remote control.

When [ HIDE MENU] is ON, cancel it.

2. Press the [] button on the front operating panel or the [] button on the wireless remote control to switch the mode to the SD mode.

One image saved on the SD card is displayed. [SINGLE]

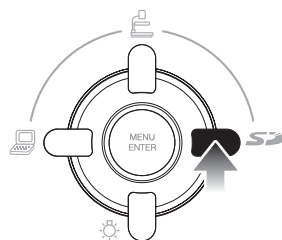



3. Press the [MENU/ENTER] button on the front operating panel or wireless remote control.



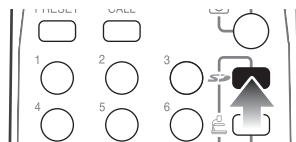

The OSD SD Single menu appears.

When the OSD SD Split screen menu appears, select [ DISPLAY] → [SINGLE].



4. When the cursor is on any icon other than the [ BACK] icon, press the [] button on the front operating panel or wireless remote control and select the image to be deleted.

For details of the operation for selecting the image saved on the SD card from the OSD SD Single menu, refer to P.131.

5. Select [ DELETE] → [CURRENT] → [Yes] from the OSD SD Single menu by using the [] [] [] [] buttons on the front operating panel or wireless remote control.

The image in display is deleted. However, if the image is locked, it cannot be deleted.

To clear all images saved on the SD card, select [ DELETE] → [ALL] → [Yes].

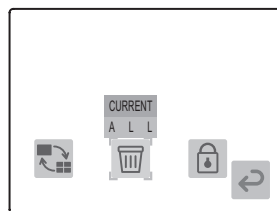

OSD SD Single Menu



Note:

- The image cannot be deleted from the OSD SD Split screen menu.
To delete the image from the OSD SD Split screen menu, bring the cursor to the image to be deleted, press the [MENU/ENTER] button on the front operating panel or wireless remote control to switch the menu to the OSD SD Single menu, and delete the selected image from the OSD SD Single menu.

For Formatting SD Card

1. When the OSD menu is in display, hide the OSD menu by operating the front operating panel or repeatedly pressing the [BACK] button on the wireless remote control.

When [ HIDE MENU] is ON, cancel it.

2. Press the [] button on the front operating panel or the [] button on the wireless remote control to switch the mode to the SD mode.

One image saved on the SD card is displayed. [SINGLE]

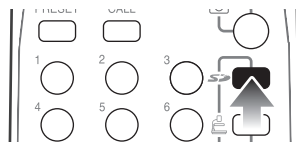
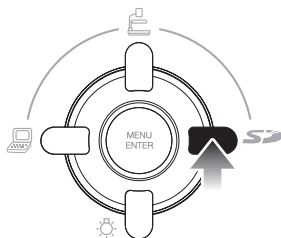

3. Press the [MENU/ENTER] button on the front operating panel or wireless remote control.

The OSD SD Split screen menu appears.

When the OSD SD Single menu appears, select [ DISPLAY] → [3x3] or [4x4].

4. Select [ FORMAT MEDIA] → [Yes] by using the [   ] buttons on the front operating panel or wireless remote control.

The format starts.

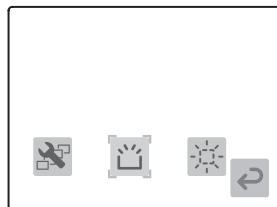

OSD SD Thumbnail Menu

For Importing Image from SD Card into PC through USB Cable

When the PC is connected to the Camera with the USB cable, the image data saved on the SD card can be imported into the PC.

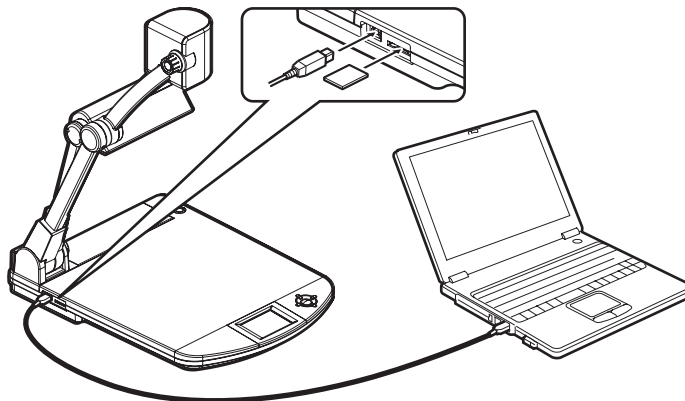

Note:

- The PC installed with the OS of Microsoft Windows2000 (SP4 or newer), XP (SP2 or newer) or Vista (32 bits) is connectable
- For details of the USB mode, refer to OSD Setting Menu (P.98)
- Under the influence of the USB environment or peripheral units used by the PC, image transfer may be disturbed.
- The image importation as per above is not always guaranteed in any environment.

1. When the OSD menu is in display, hide the OSD menu by operating the front operating panel or repeatedly pressing the [BACK] button on the wireless remote control.

When [ HIDE MENU] is ON, cancel it.

- Press the [▲] button on the front operating panel or the [📡] button on the wireless remote control to switch the output video to the camera video.

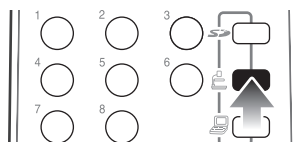
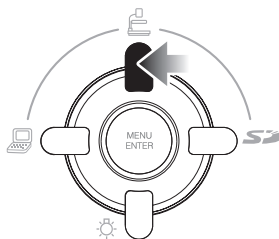



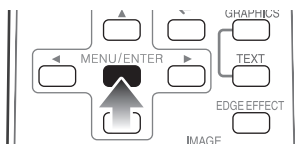
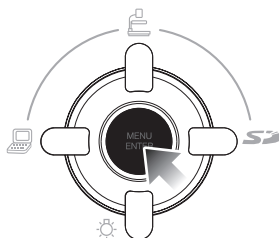

- Press the [MENU/ENTER] button on the front operating panel or wireless remote control.
The OSD Main menu appears.

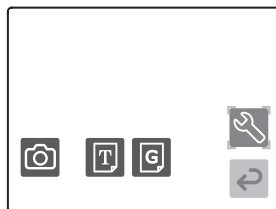

- Select [🔧 SETTINGS] from the OSD Main menu by using the [▲▼◀▶] buttons on the front operating panel or wireless remote control. OSD
The OSD Setting menu appears.



OSD Main Menu

5. Select [ USB MODE] → [MASS STORAGE] from the OSD Setting menu by using the [   ] buttons on the front operating panel or wireless remote control.

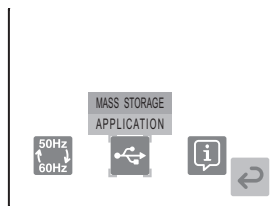

OSD Setting Menu

6. Connect the USB cable to the PC.

The Camera is recognized as a removable disk. The image data saved on the SD card can be viewed by using the viewer software on the PC.

- The image data has been saved as JPG files in the following folders:

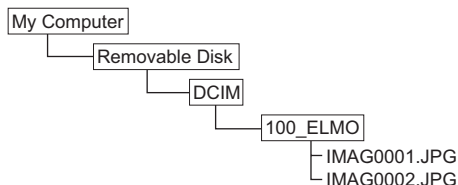

Note:

- When the USB cable is connected to the PC for the first time, the necessary driver is installed automatically by the Plug-and-Play function of Windows. For the second and subsequent connections, the driver installation will not be displayed.
- The image cannot be saved, deleted, locked or unlocked or the SD card cannot be formatted from the PC.
- The image file cannot record the correct date and time.
- When the power supply to the Camera is ON, do not plug/unplug the USB cable into/from the Camera, or malfunction will be caused to the Camera or PC.
- Do not switch [USB MODE] on the OSD during the USB connection.
- It is recommendable that the USB cable to be used should be of USB 2.0 complied.
- When the PC is connected to the Camera with the USB cable, the frame rate of the camera video is lowered.

Ref. ⑦ For Connecting to PC with USB Cable (P.110)

Using Bundled Software

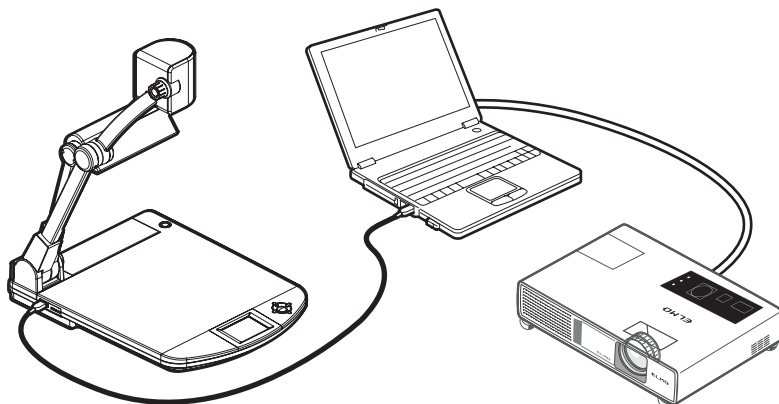

The "Utility Software" is available on the CD-ROM provided from ELMO Co., Ltd..

The "Utility Software" includes PC link software "Image Mate for Presentation" and "Image Mate for Movie Creation" and TWAIN driver "ELMO TWAIN DS (VHQ)" for enabling the following operations:

- Moving/still image transfer to the PC
- Operation of the Camera from the PC



Note:

- For details of the hardware requirements of the PC to be connected and how to use the OS, PC and link software, refer to the installation manual of the "Utility Software" and "HELP Folder" on the CD-ROM.
- When the power supply to the Camera is ON, do not plug/unplug the USB cable into/from the Camera, or malfunction will be caused to the Camera.
- It is recommendable that the USB cable to be used should be of USB 2.0 complied.
- When the PC is connected to the Camera with the USB cable, the frame rate of the camera video is lowered.
- When the dedicated software is in use, do not switch the mode to the SD mode, or malfunction will be caused to the Camera.

For Using Bundled Software

1. When the OSD menu is in display, hide the OSD menu by operating the front operating panel or repeatedly pressing the [BACK] button on the wireless remote control.

When [ HIDE MENU] is ON, cancel it.



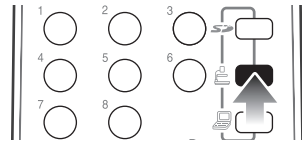
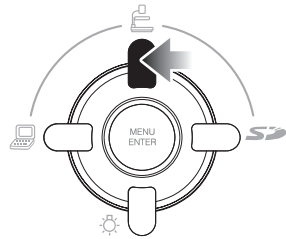

2. Press the [] button on the front operating panel or the [] button on the wireless remote control to switch the output video to the camera video.

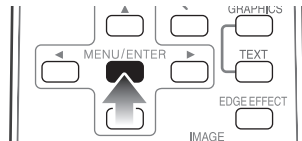
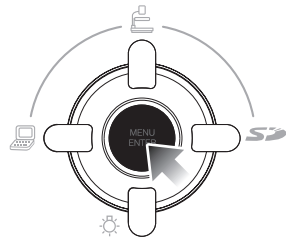

3. Press the [MENU/ENTER] button on the front operating panel or wireless remote control.

The OSD Main menu appears.





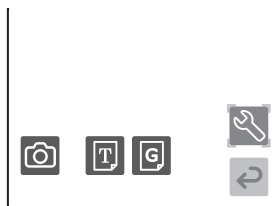

4. Select [ SETTINGS] from the OSD Main menu by using the [] buttons on the front operating panel or wireless remote control.

The OSD Setting menu appears.



OSD Main Menu

5. Select [ USB MODE] → [APPLICATION] from the OSD Setting menu by using the [] buttons on the front operating panel or wireless remote control.

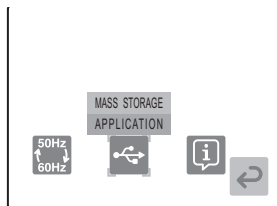

OSD Setting Menu

6. Connect the USB cable to the PC.

The moving/still image data can be transferred to the PC or the Camera can be controlled from the PC.

Ref.

 **For Connecting to PC with USB Cable (P.110)**

Shooting off the Stage

For Shooting Forward and Backward from The Camera

1. Set the camera head in the horizontal direction.

The camera head is adjusted automatically so that the camera video output cannot be inverted.

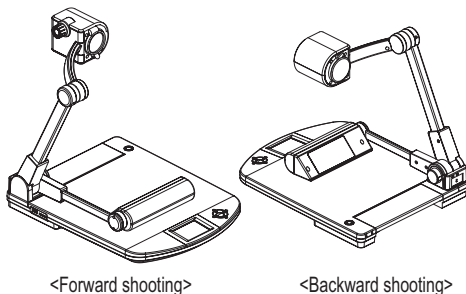

Note:

- The manual rotation of the camera video output can be adjusted by selecting [IMAGE ROTATION] → [ON] or [OFF] from the OSD Setting menu or by pressing the [IMAGE ROTATION] button on the wireless remote control.

For Shooting Wall or Landscape

1. Open the close-up lens holder.

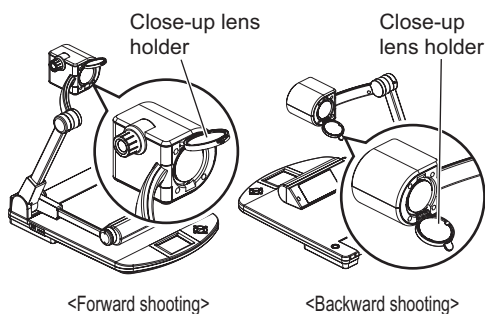

2. Shoot a wall or landscape.

Imaging range when the close-up lens holder is open:

TELE side (Telescopic): 500mm - ∞ (19.7 in - ∞) from the zoom lens

WIDE side (Wide-angle): 100mm - ∞ (3.9 in - ∞) from the zoom lens

Note:

- Do not fold the camera column without closing the close-up lens holder. The close-up lens may be damaged.

Presentation Using Films

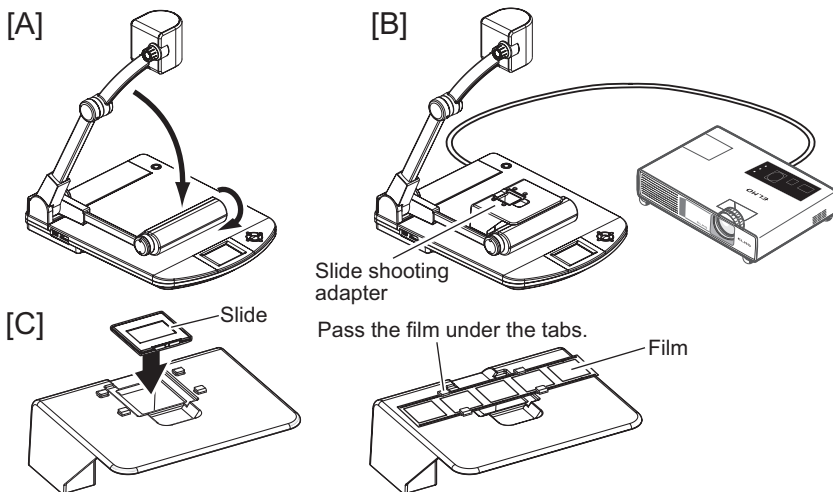

1. Set the main unit.

Fold only the lamp column of the main unit (Fig. [A]), connect the projector or PC monitor to the main unit, and turn ON the power supply to the Camera.

2. Set the slide shooting adapter.

Place the supplied slide shooting adapter over the lamp head, and adjust, while watching the screen, its position so that the opening of the slide shooting adapter can be positioned in the center of the screen (Fig. [B]).

3. Adjust the size.

Set the slide or film on the slide shooting adapter (Fig. [C]), and adjust the slide size so that it can fit the screen size by using the zoom dial on the camera head or the zoom buttons [⊕][⊙] on the wireless remote control.

4. Adjust the focus.

Press the [AF] button on the camera head or wireless remote control to bring the camera into focus.

5. Adjust the brightness.

If the screen is too bright or too dark, adjust the brightness by selecting [BRIGHTNESS SETTING] from the OSD Setting menu or pressing the BRIGHTNESS [☉] or [☉] button on the wireless remote control.

Note:

- According to the film to be used, switch the display settings by selecting [☐ POSI/NEGA] → [POSI]/[NEGA] from the OSD Setting menu or pressing the [POSI/NEGA] button on the wireless remote control.
- If the screen looks still dark after adjusting the screen brightness, put a white sheet or the like on the stage and then set the slide shooting adapter thereon, and the brightness will be improved.

ABOUT RS-232C

Connecting RS-232C

When the RS-232C terminal is connected to the PC, the Camera can be controlled from the PC.

For Setting up

To use communication control, be sure to set the Camera and the PC as follows:

1. Connect the Camera to the PC with an RS-232C cable.

Note:

- When using a commercial RS-232C cable, make sure that the pins are connected as shown below.
- To protect the Camera and the PC, be sure to turn OFF the power switch of each unit before starting the connection work.

2. Start the PC, and set the communication mode of the RS-232C to the communication mode of the Camera.

Note:

- For the information how to set the communication mode of the RS-232C, refer to the instruction manual of the PC.

3. Start the program to operate the Camera from the PC.
The RS-232C control starts.

How to connect the cables

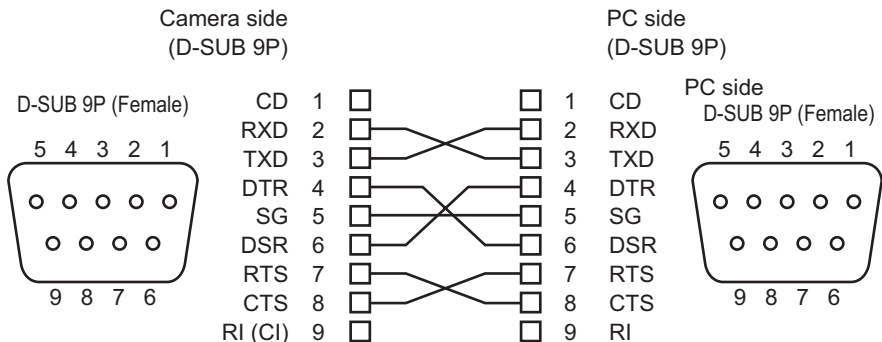

Specifications of RS-232C

Data Format Specifications

This command is executed in the form of 1 command/1 packet. Until one processing is completed, the next command is not accepted.

- The communication command always starts with STX (Start of Text) and ends with ETX (End of Text).
- If the communication format or command name is wrong, the Camera will not respond normally but send NAK (Abnormal receiving: Negative Acknowledge).
- When the correct communication format is received, the Camera sends ACK (Normal receiving: Acknowledge).

Operation command (PC → Camera)

Each operation command is executed in ASCII code, and transmitted in a set of 7 bytes as follows:

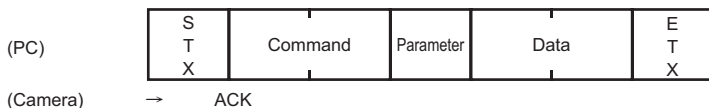

Response data format (Camera → PC)

All response data is transmitted in ASCII code, corresponding to the parameters in the operation command table.

• Status 0

S T X	Lamp	Guide	Posi /Nega	Color /B&W	Output video	Display	Pause	Flickerless	E T X
-------------	------	-------	---------------	---------------	-----------------	---------	-------	-------------	-------------

• Status 2

S T X	Iris	Gamma switching	Image rotation	Edge effect	White balance	Text	Resolution	USB mode	E T X
-------------	------	--------------------	-------------------	----------------	------------------	------	------------	-------------	-------------

• ROM Ver.1 (SLAVE)

S T X	V 56H	H 48H	Q 51H	* * H	* * H	* * H	E T X
-------------	----------	----------	----------	-------	-------	-------	-------------

• ROM Ver.2 (LENS)

S T X	V 56H	H 48H	Q 51H	* * H	* * H	* * H	E T X
-------------	----------	----------	----------	-------	-------	-------	-------------

• ROM Ver.3 (MAIN) ... Upper 6 bytes

S T X	* * H	* * H	* * H	* * H	* * H	* * H	E T X
-------------	-------	-------	-------	-------	-------	-------	-------------

• ROM Ver.4 (MAIN) ... Lower 4 bytes

S T X	* * H	* * H	* * H	* * H	20H	20H	E T X
-------------	-------	-------	-------	-------	-----	-----	-------------

Communication Specifications

- Full-duplex asynchronous method
- Start bit: 1 bit
- Data bit: 8 bits
- Stop bit: 1 bit
- Parity bit: None
- X parameter: None
- Baud rate (Communication speed): 9600bps

UART Communication Format

Commands, parameters and data are all transmitted in ASCII code.

Operation	Command	Parameter	Data	Function
Auto focus	AF	0	■ ■	To perform the one-shot auto focus.
Focus adjustment	FO	+ (Near)	■ ■	To adjust the focus.
		- (Far)		
		0 (Stop)		
Zoom adjustment	ZO	+ (Tele)	■ ■	To adjust the zoom.
		- (Wide)		
		0 (Stop)		
Iris adjustment	IR	+ (Open)	■ ■	To adjust the iris.
		- (Close)		
		0 (Stop)		
		1 (Auto)		
		2 (Manual)		
Lamp switching	PL	0 (OFF)	■ ■	To turn ON/OFF the lamp.
		1 (BASE)		
		2 (UPPER)		
Output video switching	AV	0 (Camera)	■ ■	To switch the output video.
		1 (RGB IN)		
		2 (SD)		
Direction	KE	0 (Menu)	■ ■	To select the OSD menu item, and scroll the screen when the digital zoom is in operation. To feed forward/backward the saved images in the SD mode.
		1 (Enter)		
		2 (→)		
		3 (←)		
		4 (↑)		
		5 (↓)		
Pause	FZ	0 (OFF)	■ ■	To pause the video.
		1 (ON)		

* For " ■ ■ " in the data column, transmit the SPACE [20H] twice.

Operation	Command	Parameter	Data	Function
Guide	GU	0 (OFF)	■ ■	To set whether the main unit operation status should be displayed on the screen or not.
		1 (ON)		
Display	DP	0 (Single)	■ ■	To set the split screen display in the SD mode.
		1 (3x3)		
		2 (4x4)		
Slide show	SS	0 (Stop)	■ ■	To start/stop the slide show.
		1 (Start)		
Slide show image feed effect	SE	0 (Left to right)	■ ■	To set the visual effect of the slide show.
		1 (LT to RB)		
		2 (RT to LB)		
		3 (None)		
Slide show object file	ST	0 (All)	■ ■	To select whether the slide show object should be all images recorded on the SD card or only the locked image file.
		1 (Locked)		
Slide show feed order	SO	0 (FWD)	■ ■	To set whether the slide show should be performed in the ascending order or in the descending order.
		1 (BWD)		
Slide show image feed interval	SI	0 (3s)	■ ■	To set the image switching interval of the slide show.
		1 (5s)		
		2 (10s)		
		3 (15s)		
		4 (30s)		
Slide show repeat	SR	0 (OFF)	■ ■	To perform the slide show repeatedly.
		1 (ON)		
File delete	DE	0 (Current)	■ ■	To delete the image files on the SD card.
		1 (All)		
File lock	SL	0 (Current)	■ ■	To lock the image files on the SD card.
		1 (All)		
File unlock	SU	0 (Current)	■ ■	To unlock the locked image files on the SD card.
		1 (All)		
Format	SF	0	■ ■	To format the SD card.
Image saving	CA	0	■ ■	To save the selected images on the SD card.
USB mode	UM	0 (Mass Storage)	■ ■	To switch the USB mode.
		1 (Application)		
Gamma setting	GM	0 (High)	■ ■	To set the gamma value of the video.
		1 (Normal)		
		2 (Low)		
Flickerless	FL	0 (60Hz)	■ ■	To set the flickerless.
		1 (50Hz)		
Language setting	LG	0 (English)	■ ■	To set the language.
		1 (Japanese)		

* For " ■ ■ " in the data column, transmit the SPACE [20H] twice.

Operation	Command	Parameter	Data	Function
Resolution switching	RL	1 (SXGA)	■ ■	To switch the resolution.
		2 (XGA)		
		3 (HD)		
Image Rotation	RO	0 (0°)	■ ■	To rotate the image.
		1 (180°)		
Edge effect	AP	0 (OFF)	■ ■	To set the edge effect.
		1 (Low)		
		2 (Mid)		
		3 (High)		
White balance	AW	0 (Manual)	■ ■	To switch the White Balance mode.
		1 (Auto)		
		2 (One Push)		
		3 (R_Up)		
		4 (R_Down)		
		5 (B_Up)		
Text	CT	0 (GRAPHICS)	■ ■	To set the contrast.
		1 (TEXT1)		
		2 (TEXT2)		
		3 (TEXT3)		
Posi/Nega	NP	0 (Posi)	■ ■	To set the Posi/Nega.
		1 (Nega)		
Color/B&W	CB	0 (Color)	■ ■	To set the Color/B&W.
		1 (B&W)		
Local lockout	LL	0 (OFF)	■ ■	To invalidate the operation of the front operating panel and wireless remote control.
		1 (ON)		
Default	DF	0	■ ■	To reset to the default settings.
Status request	QS	0	■ ■	To inquire about the unit status.
		2		
White balance	AW	0 (Manual)	■ ■	To switch the White Balance mode.
ROM version	QR	1	■ ■	To inquire about the ROM version.
		2		
		3		
		4		
ACK check	SA	0 (OFF)	■ ■	To switch the ACK Check mode.
		1 (ON)		
CR addition	SC	0 (OFF)	■ ■	To switch the CR addition settings.
		1 (ON)		

* For " ■ ■ " in the data column, transmit the SPACE [20H] twice.



Note:

- If the RS-232C cable is not connected correctly between the Camera and the PC, no ACK is transmitted.
- Connect the RS-232C cable correctly, and fix it firmly with the connector set screws before starting the operation.

APPENDIX

Troubleshooting

If the operation of the Camera becomes abnormal, troubleshoot the abnormality by referring to the below table. If the abnormality still remains after troubleshooting, consult the sales outlet from whom you have purchased the Camera or our branch or sales office nearest your location.

Symptom	Check item	Reference page
No image is displayed	Is the cable connected correctly?	P.107
	Isn't the power plug unplugged from the wall outlet?	—
	Isn't the DC cord plug of the AC adapter unplugged from the power socket of the Camera?	P.107
	Is the power switch ON?	P.112
	Isn't the zoom set at the TELESCOPIC side, displaying only the white part or black part of the object (document)?	P.117
	When the power switch is turned ON immediately after it is turned OFF, the Camera may not start immediately. In this case, wait for several seconds after turning OFF the power switch, and then turn it ON.	—
The image is out of focus.	Isn't the object (document) too close to the lens?	P.119
	Isn't the zoom focused at the WIDE-ANGLE side and then set to the TELESCOPIC side? Focus on the point of max at the TELESCOPIC side.	P.119
	In the auto focus, focusing may be difficult.	P.119
The video output image is disarrayed.	Isn't the video output set to the PAL system? If the Camera is set to the PAL system and connected to the monitor specially designed for the NTSC system, the video image may not be output normally but be disarrayed or displayed in B&W. In this case, switch the system of the video output by referring to the section of "DIP switch."	P.92
The image is too dark.	Isn't the lighting intensity insufficient? When the OSD menu is hid (excepting when [ HIDE MENU] is ON), press the [] button on the front operating panel or the [] button on the wireless remote control to turn ON the lamp.	P.115
	Isn't the iris adjusted to the CLOSE side? Adjust the iris to the OPEN side.	P.121
The image is striped.	Isn't there interference fringe between dots of printed matter and TV scanning lines or CMOS pixels? This may be mitigated by changing the projection range.	—
	When an LCD projector is used, vertical stripes may appear on the screen. This may be mitigated by manually adjusting the dot clock frequency on the projector side.	P.108
The brightness tone is out of order.	This may be mitigated by switching gamma settings.	P.98

Note:

- About the lamp (LED lamp)

The brightness of the lamp used for the Camera deteriorates as the operating time passes. If the brightness is reduced abnormally, we will replace the lamp with payment. In this case, consult the dealer from whom you have purchased the product or our branch/office near your location.

- About the use for a long time

When the Camera is used longer than the warranty period or used for a long time while the power switch remains ON, some parts may deteriorate in performance or quality due to the expiration of the service life. In this case, we will replace such parts with payment. consult the dealer from whom you have purchased the product or our branch/office near your location.

Specifications

General

Item	Specifications		
Power supply	12 VDC (AC adapter 100 - 240 VAC) "50/60Hz"		
Power consumption	24 W (including AD adapter)		
Outside dimensions	When folded W376xD482xH181mm (W14.8xD19.0xH7.1 in) When set up W376xD482xH549mm (W14.8xD19.0xH21.6 in)		
Mass	Approx. 4.6kg (10.1 lb) (Main unit only)		
Input selection	Main unit / External one system		
Output terminal	DVI-D output	DVI-D 24P connector, female	1
	RGB output	Mini D-SUB 15P connector, female	1
	Composite video output	RCA pin jack / 75Ω unbalanced (NTSC/PAL)	1
	S-video output	Mini DIN 4P connector / 75Ω unbalanced (NTSC/PAL)	1
Input terminal	RGB input	Mini D-SUB 15P connector, female	1
External control terminal	RS-232C	D-SUB 9P connector, male	1
	USB (2.0 complied)	Type B receptacle	1
Memory interface	SD card slot		1

Main body camera unit

Item	Specifications	
Camera lens	f = 4.9 - 78.4mm (0.19 - 3.09in) (16x zoom lens) F = 2.7	
Imaging speed	30 frames/sec	
Imaging range	SXGA: Max. 405x324mm (15.9x12.8 in), Min. 30x24mm (1.2x0.9 in) HD 720P: Max. 405x224mm (15.9x8.8 in), Min. 30x17mm (1.2x0.7 in) XGA: Max. 405x303mm (15.9x11.9 in), Min. 30x23mm (1.2x0.9 in)	
Focus adjustable range	With close-up lens TELE side (Telescopic): 250 - 410mm (9.8 - 16.1 in) from close-up lens WIDE side (Wide-angle): 85 - 410mm (3.3 - 16.1 in) from close-up lens Without close-up lens TELE side (Telescopic): 500mm - ∞ (19.7 in - ∞) from zoom lens WIDE side (Wide-angle): 100mm - ∞ (3.9 in - ∞) from zoom lens	
Optical zoom	16x	
Digital zoom	4x	
Focus	Auto/Manual	
Iris	Auto (level adjustable) / Manual	
Image pickup element	1/3 in 1.3M CMOS	
Total pixels	Horizontal 1312, Vertical 1032 ... Approx. 1350000 pixels	
Effective pixels	SXGA: Horizontal 1280, Vertical 1024 HD 720P: Horizontal 1280, Vertical 720 XGA: Horizontal 1280, Vertical 960	
Synchronous system	Internal	
Resolution	Analog RGB: Horizontal 800TV lines or more, Vertical 800TV lines or more Video output: Horizontal 450 lines or more	
DVI-D output	TMD5 signal DVI standard complied	SXGA: 1280x1024 at 60Hz, VESA complied, Horizontal frequency 63.98kHz, Vertical frequency 60.02Hz
Analog RGB output	0.7 (Vp-p) 75Ω unbalanced Synchronization signal SXGA: Positive polarity HD 720P: Negative polarity XGA: Negative polarity	HD 720P: 1280x720 at 60Hz, Horizontal frequency 44.7kHz, Vertical frequency 60Hz XGA: 1024x768 at 60Hz, VESA complied, Horizontal frequency 48.363kHz, Vertical frequency 60.004Hz
S-video output	NTSC/PAL complied	
Composite video output	NTSC/PAL complied	
White balance	Full auto /One push / Manual	
Video output switching	Provided (NTSC/PAL)	
Posi/Nega inversion	Provided	
Color/W&B switching	Provided	
Image rotation	Provided (0°/180°, Auto 180° rotation in Forward imaging)	
Mode	TEXT1 / TEXT2 / TEXT3 / GRAPHICS	
Gamma setting	Provided (only in the Graphic mode)	

Item	Specifications
Edge effect	Provided (only in the Graphic mode)
Video pausing	Provided
Image recording	Provided (SD card)
Split screen display	Provided (SD card images, 9 splits, 16 splits)
Slide show	Provided (SD card images)

Lighting unit

Item	Specifications
Lighting	White LED

Accessories

Name	Quantity
AC adapter	1
Power cord (1.5m (59.1 in))	1
Video RCA cable (3m (118.1 in))	1
Mini DIN 4P (for S-video) cable (2m (78.7 in))	1
Analog RGB cable (D-SUB 15P connector) (2m (78.7 in))	1
DVI cable (2m (78.7 in))	1
Infrared wireless remote control	1
Battery size AAA	2
P30S Instruction Manual	1
P30S Warranty Card	1
USB cable (1.8m (70.9 in))	1
Utility Software Installation Manual	1
Utility Software CD-ROM	1
Slide shooting adapter	1
Wireless remote control holder	1

Note:

- For RCA pin, use pin plug compliant with EIAJ RC-7603.
- These specifications are subject to change without notice.

ELMO is a trademark of ELMO Co., Ltd.

VESA and SVGA are registered trademarks of Video Electronics Standards Association.

SXGA, VGA and XGA are trademarks or registered trademarks of International Business Machines Corporation.

 : SD logo is a trademark.

Any other company names and product names appeared in this manual are trade names, trademarks or registered trademarks of the respective relevant companies.