

Teacher's ✦ Choice

ELMO

DOCUMENT CAMERA

P10

取扱説明書

ご使用に先だち取扱説明書をよくお読みいただき、大切に保存してください。

INSTRUCTION MANUAL

Please read this instruction manual carefully before using this product and keep it for future reference.

MODE D'EMPLOI

Lire attentivement ce mode d'emploi avant de mettre le Présentateur Visuel en service. Le conserver à titre de référence permanente.

BEDIENUNGSANLEITUNG

Bitte lesen Sie diese Bedienungsanleitung sorgfältig, bevor Sie das Gerät benutzen. Bewahren Sie die Anleitung als Referenz auf.

MANUAL DE INSTRUCCIONES

Antes de utilizar este producto, lea atentamente este manual de instrucciones y guárdelo para consultas futuras.

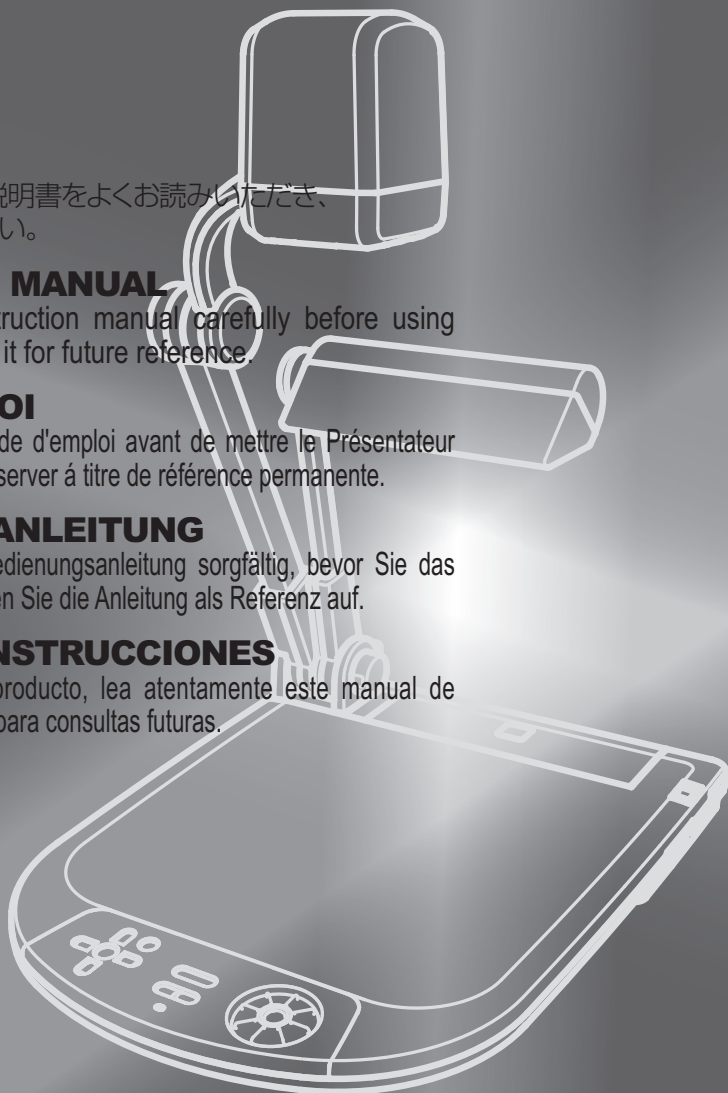

IP10

Document Camera

INSTRUCTION MANUAL

Please read this instruction manual carefully before using this product and keep it for future reference.

PART NAMES
AND
FUNCTIONS

SETTING UP

STORING

OPERATION
PROCEDURE

VARIOUS
FUNCTIONS AND
OPERATIONS

TROUBLE
SHOOTING

SPECIFICATIONS

IMPORTANT SAFEGUARDS

■ Read Instructions

All the safety and operating instructions should be read before the appliance is operated.

■ Retain Instructions

The safety and operating instructions should be retained for future reference.

■ Heed Warnings

All warnings on the product and in the operating instructions should be adhered to.

■ Follow Instructions

All operating and use instructions should be followed.

■ Cleaning

Unplug this product from the wall outlet before cleaning. Do not use liquid cleaners or aerosol cleaners. Use a damp cloth for cleaning.

■ Attachments

Do not use attachments not recommended by the product manufacturer as they may cause hazards.

■ Water and Moisture

Do not use this product near water - for example, near a bath tub, wash bowl, kitchen sink, or laundry tub, in a wet basement, or near a swimming pool, and the like.

■ Placement

Do not place this product on an unstable cart, stand, tripod, bracket, or table. The product may fall, causing serious injury to a child or adult, and serious damage to the product. Use only with a cart, stand, tripod, bracket, or table recommended by the manufacturer, or sold with the product. Any mounting of the product should follow the manufacturer's instructions, and should use a mounting accessory recommended by the manufacturer.

■ Ventilation

Slots and openings in the cabinet are provided for ventilation and to ensure reliable operation of the product and to protect it from overheating, and these openings must not be blocked or covered. The openings should never be blocked by placing the product on a bed, sofa, rug, or other similar surface. This product should not be placed in a built-in installation such as a bookcase or rack unless proper ventilation is provided or the manufacturer's instructions have been adhered to.

■ Power Sources

This product should be operated only from the type of power source indicated on the marking label. If you are not sure of the type of power supply to your home consult your appliance dealer or local power company. For products intended to operate from battery power, or other sources, refer to the operating instructions.

■ Grounding or Polarization

This product may be equipped with either a polarized 2-wire AC line plug (a plug having one blade wider than the other) or a 3-wire grounding type plug, a plug having a third (grounding) pin. The 2-wire polarized plug will fit into the power outlet only one way. This is a safety feature. If you are unable to insert the plug fully into the outlet, try reversing the plug. If the plug still fails to fit, contact your electrician to replace your obsolete outlet. Do not defeat the safety purpose of the polarized plug. The 3-wire grounding type plug will fit into a grounding type power outlet. This is a safety feature. If you are unable to insert the plug into the outlet, contact your electrician to replace your obsolete outlet. Do not defeat the safety purpose of the grounding type plug.

■ Power-Cord Protection

Power-supply cords should be routed so that they are not likely to be walked on or pinched by items placed upon or against them, paying particular attention to cords at plugs, convenience receptacles, and the point where they exit from the product.

■ Lightning

For added protection for this product during a lightning storm, or when it is left unattended and unused for long periods of time, unplug it from the wall outlet and disconnect the antenna or cable system. This will prevent damage to the product due to lightning and power-line surges.

■ Overloading

Do not overload wall outlets, extension cords, or integral convenience receptacles as this can result in a risk of fire or electric shock.

- A product and cart combination should be moved with care. Quick stops, excessive force, and uneven surfaces may cause the product and cart combination to overturn.



■ Object and Liquid Entry

Never push objects of any kind into this product through openings as they may touch dangerous voltage points or short-out parts that could result in a fire or electric shock. Never spill liquid of any kind on the product.

■ Servicing

Do not attempt to service this product yourself as opening or removing covers may expose you to dangerous voltage or other hazards. Refer all servicing to qualified service personnel.

■ Damage Requiring Service

Unplug this product from the wall outlet and refer servicing to qualified service personnel under the following conditions:

- When the power-supply cord or plug is damaged.
- If liquid has been spilled, or objects have fallen into the product.
- If the product has been exposed to rain or water.
- If the product does not operate normally by following the operating instructions. Adjust only those controls that are covered by the operating instructions as an improper adjustment of other controls may result in damage and will often require extensive work by a qualified technician to restore the product to its normal operation.
- If the product has been dropped or damaged in any way.
- When the product exhibits a distinct change in performance - this indicates a need for service.

■ Replacement Parts

When replacement parts are required, be sure the service technician has used replacement parts specified by the manufacturer or have the same characteristics as the original part. Unauthorized substitutions may result in fire, electric shock or other hazards.

■ Safety Check

Upon completion of any service or repairs to this product, ask the service technician to perform safety checks to determine that the product is in proper operating condition.

■ Heat

The product should be situated away from heat sources such as radiators, heat registers, stoves, or other products (including amplifiers) that produce heat.

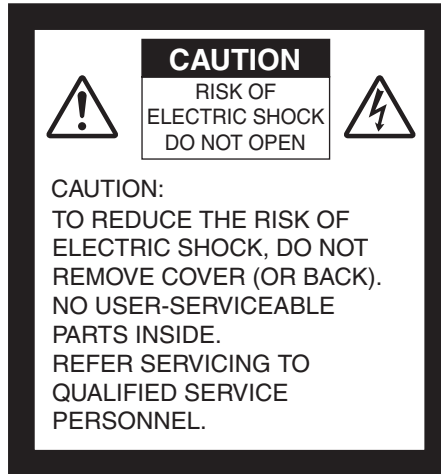

SA 1965

The lightning flash with arrowhead symbol, within an equilateral triangle, is intended to alert the user to the presence of uninsulated "dangerous voltage" within the product's enclosure that may be of sufficient magnitude to constitute a risk of electric shock to persons. This marking is located at the bottom of product.



SA 1966

The exclamation point within an equilateral triangle is intended to alert the user to the presence of important operating and maintenance (servicing) instructions in the literature accompanying the product.

WARNING:

TO REDUCE THE RISK OF FIRE OR ELECTRIC SHOCK, DO NOT EXPOSE THIS PRODUCT TO RAIN OR MOISTURE.

The connection of a non-shielded equipment interface cable to this equipment will invalidate the FCC Certification or Declaration of this device and may cause interference levels which exceed the limits established by the FCC for this equipment. It is the responsibility of the user to obtain and use a shielded equipment interface cable with this device. If this equipment has more than one interface connector, do not leave cables connected to unused interfaces. Changes or modifications not expressly approved by the manufacturer could void the user's authority to operate the equipment.

**FOR UNITED STATES USERS:
INFORMATION**

This equipment has been tested and found to comply with the limits for a Class B digital device, pursuant to Part 15 of the FCC Rules. These limits are designed to provide reasonable protection against harmful interference in a residential installation. This equipment generates, uses, and can radiate radio frequency energy and, if not installed and used in accordance with the instructions, may cause harmful interference to radio or television reception. However, there is no guarantee that interference will not occur in a particular installation. If this equipment does cause interference to radio and television reception, which can be determined by turning the equipment off and on, the user is encouraged to try to correct the interference by one or more of the following measures.

- Reorient or relocate the receiving antenna.
- Increase the separation between the equipment and receiver.
- Connect the equipment into an outlet on a circuit different from that to which the receiver is connected.
- Consult the dealer or an experienced radio/TV technician for help.

**USER-INSTALLER
CAUTION:**

Your authority to operate this FCC verified equipment could be voided if you make changes or modifications not expressly approved by the party responsible for compliance to Part 15 of the FCC rules.

WARNING:

Handling the cord on this product or cords associated with accessories sold with this product, will expose you to lead, a chemical known to the State of California to cause birth defects or other reproductive harm.

Wash hands after handling.

Before You Use

- Be sure to use the power cord applicable to your local power specifications. If the product was sold in Japan, use the power cord or AC adapter sold with the product with 100 VAC and 50 or 60 Hz.
- When storing the product, do not leave it under direct sunlight or by heaters. It may become discolored, deformed, or damaged.
- Do not place this product in any humid, dusty, salt bearing wind, or vibrating locations.

Only use it under the following environmental conditions:

Temperature: 0°C - 40°C (32°F - 104°F)

Humidity: 30% - 85% (No condensation)

- Use a soft, dry cloth for cleaning.

Do not use any volatile solvent such as thinner or benzene.

- Do not point the camera lens directly at the sun. This may damage to the device.
- Luminescent and Black Spots

There may be some pixels that do not properly operate due to the use of CMOS Area Image Sensors made up of many pixels.

Though luminescent or black spots may be found on the screen, it is a phenomenon peculiar to the CMOS Area Image Sensors and is not a malfunction.

- Follow the guidelines below to prevent the unit from dropping or overturning.
 - Use the product on a stable base, desk, or table. Do not place the product on an unstable base or slanted surface.
 - Place or wire the unit to prevent the AC adapter cord or video cable from pulling.
- Carry the product by holding the lower part of the main unit in both hands. Never hold the product by the column or the camera head.
- Pay careful attention when using (including setting-up and storing) or transferring the product, to prevent the camera head from receiving any shocks.
- Do not look directly into the LED light, this can damage your eyes.
- Transfer the data from the SD card onto a device such as a PC to save a backup copy. Malfunction of the product or repairs to it may cause the data saved in the SD card to be deleted.
- If this product is used for longer than the warranty period, its performance and quality may deteriorate due to the lifetime of its parts. To purchase replacement parts, consult the dealer from whom you purchased this product or our branch/office near your location.

■ Battery precautions:

If this product is not going to be used for a long time, take the batteries out of the remote control.

Do not use rechargeable batteries (e.g. Hi-MH (nickel-metal hybrid batteries)).

Do not use new and old batteries or batteries of different types together.

Do not try to recharge or short-circuit the batteries.

When disposing of used batteries, follow the instructions of your local government.

Insert from one side and pay particular attention to the polarity (+/- directions).

Be sure to use AAA batteries.

If any liquid from a battery leaks onto your skin or clothes, flush the area with clean water immediately. If it gets into your eye, flush immediately with clean water and then contact a doctor.

■ Precautions regarding the remote control strap

To prevent unexpected accidents, please note the following points.

- This strap is for the remote control only and should not be used for any other purposes.
- Do not wrap the strap around parts of your body such as your neck, arm, or finger.
- Do not leave it within reach of small children.
- For safety reasons, the break-away section of the strap has been designed to separate if too much force is applied. Therefore, please avoid any overly strenuous movements and do not apply excessive force.
- The strap length adjustment feature is designed to be simple and supportive. Excessive force or strenuous movements may change the length.
- Do not use excessive force when adjusting the strap. This could damage the strap.



CONTENTS

IMPORTANT SAFEGUARDS	68
Before You Use	73
CONTENTS	75
1. PART NAMES AND FUNCTIONS	77
Part Names	77
Appearance	77
List of Functions	78
Front operating panel	78
Rear panel	80
Side panel	81
Remote control	82
List of functions	83
OSD (On-Screen Display)	86
Camera mode OSD menu	88
SD mode OSD menu	93
SD menu	94
2. SETTING UP	96
Setting Up	96
Connecting the AC Adapter and Video Cable	98
3. STORING	101
Storing	101
4. OPERATION PROCEDURE	102
Presentation Using Printed Materials, etc.	102
Presentation Using an SD Card (Commercially-available)	104
Transferring Images From the SD Card to a USB-connected PC	108
Presentation Using the Supplied Software with a USB-connected PC	110
Shooting Off the Stage	111
Presentation Using Film	112
5. VARIOUS FUNCTIONS AND OPERATIONS	113
Zoom	113
Focus	114
Auto Focus (AF)	114
Normal AF mode	115
One-shot AF mode	115
Manual focus	116
Illumination	117
Lamp positioning	117
Adjusting the Brightness	118
Automatic brightness adjustment	118
Manual brightness adjustment	118
Image Selection	119
White Balance	120
How to use [Auto]	120
How to use [One-Push]	120
How to use [Manual]	120

Save/call Settings	121
How to save settings	121
How to call settings	122
Highlight Function.....	123
Mask Function	125
Scroll Function	126
PIP (Picture in Picture) Function	127
Using a Desktop Recorder (Optional)	128
6. TROUBLE SHOOTING.....	129
Symptoms and Confirmation	129
7. SPECIFICATIONS.....	131
General	131
Main camera.....	131
Illumination device.....	132
Supplied Accessories.....	133

1 PART NAMES AND FUNCTIONS

Part Names

■ Appearance

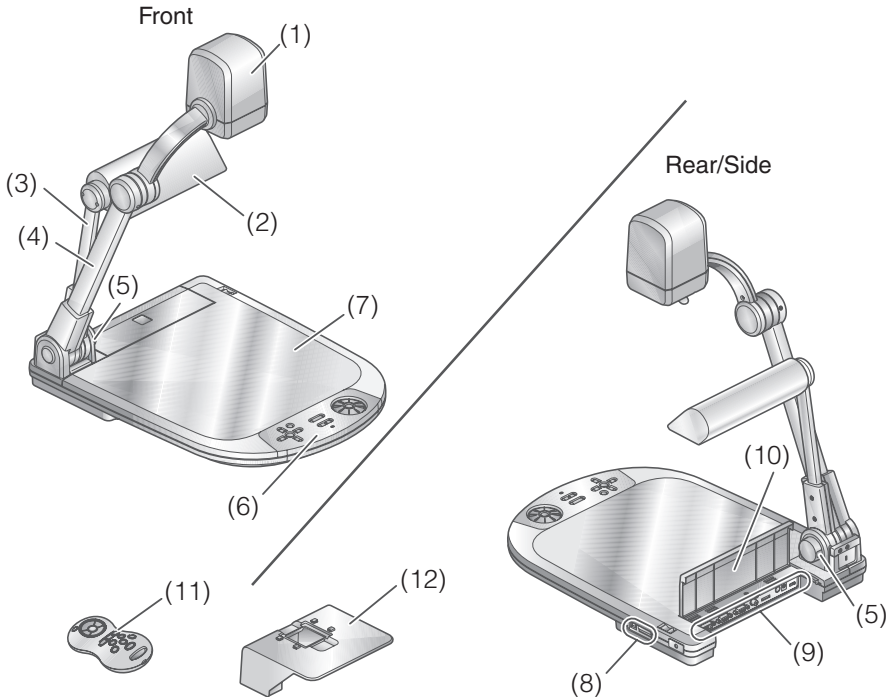

Front

Number	Name
(1)	Camera head
(2)	Lamp head
(3)	Lamp column
(4)	Camera column
(5)	Infrared receiver
(6)	Front operating panel P.78
(7)	Stage

Rear/Side

Number	Name
(8)	Side panel P.81
(9)	Rear panel P.80
(10)	Cord cover
(11)	Remote control P.82
(12)	Slide shooting adapter P.112

Note





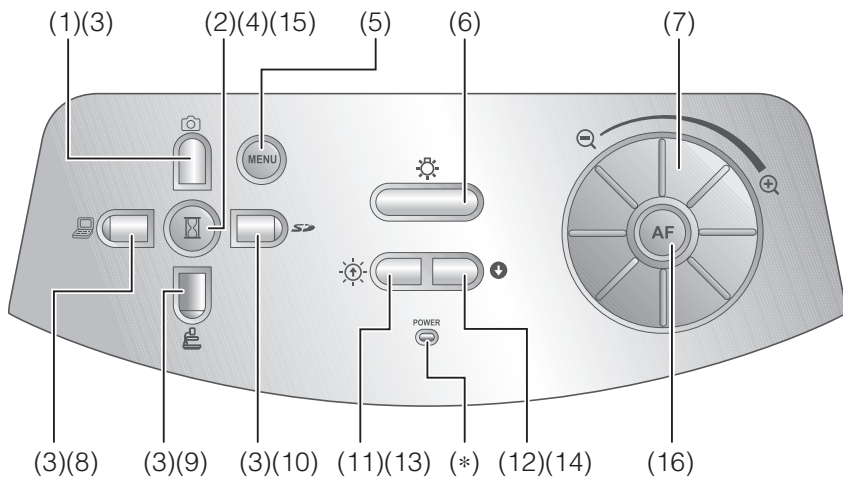

- Open the cord cover when connecting or disconnecting the cord.
- Do not carry by the cord cover.









List of Functions

■ Front operating panel











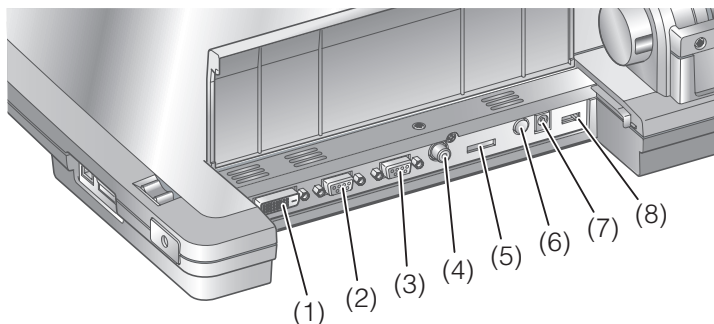

* From here on, menu items displayed/selected on the monitor or the projection screen are referred to as “OSD (On-Screen Display).”

	Name	Function
(*)	 (POWER LED)	Flashes blue when the power is turned on. Power ON: Lit blue Standby status (remote control OFF): Lit red
(1)	 (Image save)	To save the image on the SD card. ▶ P.105
(2)	 (Pause)	To pause the camera image. Press this button again to restart.
(3)	OSD operations ▶ P.86    (Direction)	To select an OSD menu item.
(4)	 (Decision)	To decide the OSD item.
(5)	MENU	To show/hide the OSD menu. The LEDs for operation buttons are not lit during OSD menu display. ▶ P.86

	Name	Function
(6)	 (Lamp)	To switch illumination ON/OFF.
(7)	ZOOM	Turn the dial to operate Zoom. P.113
(8)	Image select  (PC)	To switch the output image to the image input to RGB IN. The LED is lit when RGB IN image is selected as the output image. P.119
(9)	 (CAMERA)	To switch the output image to camera image. The LED is lit when camera image is selected as the output image. P.119
(10)	 (SD mode)	To switch the output image to images stored on the SD card. The SD Mode LED is lit in SD Mode. P.119
(11)	Adjusting the brightness 	To brighten the camera image. P.118
(12)		To darken the camera image. P.118
(13)	SD mode operation 	Single Display: Return to the previous image. 4x4 Display: Move the cursor to the previous image.
(14)		Single Display: Move to the next image. 4x4 Display: Move the cursor to the next image.
(15)		Change between SD image single display and 4x4 display.
(16)	AF (Auto Focus)	To perform One-shot Auto Focus. P.114

■ Rear panel



	Name	Function	Images you can change to with the Image select button
(1)	DVI OUT (DVI Output Terminal)	To output digital video signal to a projector, a PC monitor, or other DVI input device. 	<input type="checkbox"/> Camera image <input type="checkbox"/> SD Mode
(2)	RGB OUT (Analog RGB Output Terminal) 	To output analog video signal to a projector, a PC monitor, or other RGB input device. 	<input type="checkbox"/> Camera image <input type="checkbox"/> [RGB IN] Image <input type="checkbox"/> SD Mode
(3)	RGB IN (Analog RGB Input Terminal) 	To output the image input to this terminal when [PC] is selected by Image select button. 	
(4)	VIDEO OUT (Composite Video Output Terminal) 	To output images from the RCA pin-jack terminal to the NTSC/PAL-system monitor (e.g., TV monitor). 	<input type="checkbox"/> Camera image <input type="checkbox"/> SD Mode
(5)	RECORDER (Recorder Terminal)	Terminal to connect the optional desktop recorder via a dedicated cable. By connecting to the desktop recorder, you can record camera images from this device. Refer to the manual for the optional desktop recorder for more details.	
(6)	DC IN 12V (Power Socket) 	Plug-in for the AC adapter.	
(7)	DC OUT (Power Outlet)	Connect optional items and output.	
(8)	RESOLUTION/VIDEO (Change Resolution Switch) 	To change the resolution of the output analog image. [A] SXGA/720p : 1280x1024/1280x720 [B] WXGA : 1280x800 [C] XGA : 1024x768 [D] VIDEO : NTSC/PAL	

■ Side panel

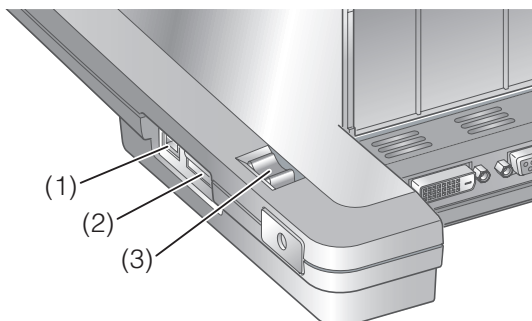

	Name	Function
(1)	USB (2.0 Compliant)	By connecting to a PC, you can transfer data stored on an SD card to your PC, or transfer images and control the main unit using the software contained in the supplied Image Mate CD-ROM. P.98
(2)	 (SD card slot)	To insert an SD card into the SD card slot. Push the card again to remove the SD card. P.104
(3)	Main switch	To turn the power ON/OFF.

Note

- Only one image can be output at a time; either [RGB OUT] and [DVI OUT], or [VIDEO OUT]. ([RGB OUT] and [DVI OUT] can be output at the same time, however [VIDEO OUT] cannot be output simultaneously.)
- When the RESOLUTION/VIDEO (Change Resolution Switch) is set to [VIDEO], the image input to [RGB IN] is not output from [RGB OUT] or [DVI OUT].
(Unable to operate the [PC] button on the main unit.)
(Unable to record or playback from the optional desktop recorder.)
- [PC] mode can only be selected when [RGB OUT] is set.
Enters [CAMERA] mode when RESOLUTION/VIDEO (Change Resolution Switch) is set to [VIDEO OUT] in [PC] mode. The camera image status remains active even if [PC] mode is selected in [DVI OUT].

■ Remote control

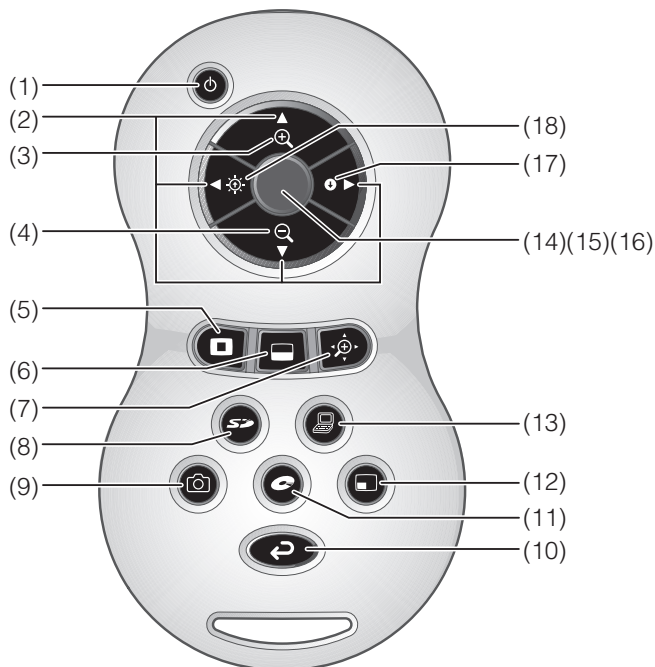

Note













- When setting the batteries, remove the battery case cover by pushing the [▼] mark in the arrow direction on the back side of the remote control, and set 2 AAA batteries in the case.
- Insert from one side and pay particular attention to the polarity (+/- directions).
- Do not use new and old batteries or batteries of different types together.
- Be sure to use AAA batteries.
- Replace the batteries with new ones at least once a year.
- Use the supplied batteries for an initial operation check. The operating life is not guaranteed.



Warning

Because there is a chance that small batteries could be ingested, be sure to keep them out of the reach of children. If a battery is swallowed, consult a doctor immediately, as this could result in suffocation or an obstacle to digestion etc.

■ List of functions





	Name	Function
(1)	 (POWER ON/OFF standby status)	To turn the power ON/OFF. Only operates when the main power switch is ON.
(2)	SD mode/ highlight/ mask/scroll operations	 (Direction) To move forward/backward through the images saved in SD mode. Moves the highlight section in highlight mode, moves the mask section in mask mode, and moves the displayed image in scroll mode. Moves the small screen during PIP. To decide the OSD cursor for the recorder in Recorder mode.
(3)	ZOOM	 (TELE) To Zoom in. P.113
(4)		 (WIDE) To Zoom out. P.113
(5)	 (Highlight)	To highlight part of the image displayed. *1
(6)	 (Mask)	To mask an area of the output image. *1
(7)	 (Scroll)	To enlarge the image currently displayed and move up, down, left, and right. *1
(8)	 (SD mode)	To switch the output image to SD mode. P.119
(9)	 (Capture)	To save the image on the SD card. P.105
(10)	 Back	To return the output image to camera image.
(11)	 (Recorder)	To operate an optional desktop recorder. *2
(12)	 PIP (Picture in Picture)	To display a still image as a small picture while displaying a camera image.
(13)	 (PC)	To switch the output image to the image input to RGB IN. P.119

Note

*1 This function can only be operated while displaying camera mode/SD mode.

(Cannot be used in conjunction with other functions.)

*2 Cannot be used when the desktop recorder is not connected.

	Name		Function
(14)	AF (Auto Focus)		To perform One-shot Auto Focus. P.114
(15)	SD mode operations		Change between SD image single display and 4x4 display.*3
(16)	Recorder mode operations		To decide the OSD cursor for the recorder.
(17)	BRIGHTNESS (Brightness adjust)	 (Dark)	To darken the camera image. P.118
(18)		 (Bright)	To brighten the camera image. P.118



Note

*3 This function can only be used in SD mode.

Remote Control Reception

Point the transmission unit of the remote control at the sensor unit located on the front of the camera main unit, press the operation button for the intended operation, and operate the camera main unit accordingly.

Receivable Range

Distance: Within approx. 7m (23ft) from the front face of the remote control sensor unit.

Angle: Within 30° up, down, left, and right from the remote control sensor unit.

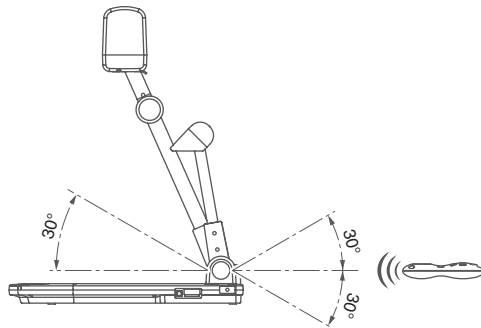
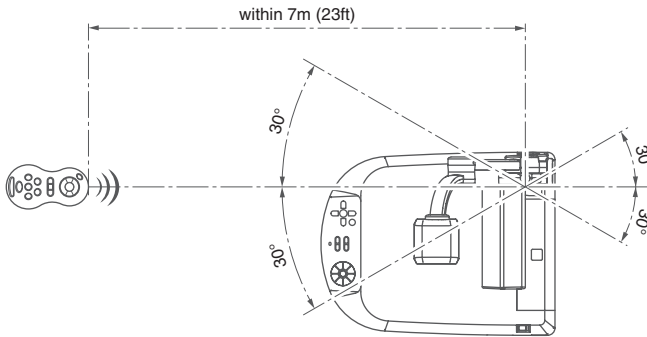

Note

- The receivable range may be shortened or narrowed and the laser beam from the remote control may not be sensed depending on the surrounding circumstances (e.g., sunlight, position adjacent to inverter fluorescent lamp). In this case, relocate the receiving side or shield the sunlight or fluorescent lamp.

OSD (On-Screen Display)

OSD is used to display characters such as text and icons on a monitor or projection screen. It displays this device's menu screens for various operations and settings.

In this manual, this is referred to as the OSD menu.

OSD Basic Operations

The following procedure shows button operations used when setting or operating via OSD.

■ Operations for selecting and deciding icons

- 1 Press the [MENU] button on the front panel to display the OSD, and then use the [↑↓←→] buttons to move to the icon you want to operate or set.
- 2 Use the [Enter] button on the front panel to enter the setting value.

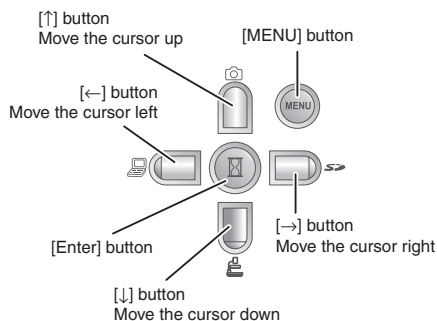

Front operating panel



■ Adjusting the level bar

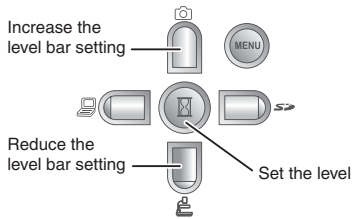

- 1 Use the [↑↓] buttons on the front panel to adjust the setting value.
- 2 Use the [Enter] button on the front panel to enter the setting value.









■ Camera mode OSD menu

After using Image select to change the output image to camera image, press the "MENU" button to display the OSD menu. **P.119**







■ Top menu

Icon	Name	Selection Item	Function
	Image Setting	–	To display the menu for adjusting and displaying camera images.
	Function Setting	–	To display the menu for function settings.
	Back	–	To hide the OSD menu display.

■ Image setting menu







Icon	Name	Conditions	Selection Item	Function
	Brightness		Auto ✓	To automatically adjust the brightness of the camera image to suit the subject of the image. You can adjust the amount of auto adjustment.
			Manual	To set the camera image to a fixed brightness.
	Reset Brightness	Brightness Auto		To reset the amount of auto adjustment to the default setting.
	AF Mode		Norm ✓	To automatically focus the camera.
			Shot	Press the [AF] button to automatically focus.
	Focus			Use the level bar to adjust the focus manually. Press the [AF] button to switch to the mode selected in AF mode, and adjust the focus.
	White Balance		Auto ✓	To automatically adjust the white balance.
			One-Push	To set the white balance to a fixed setting after carrying out automatic correction.
			Manual	To manually adjust the [R-Gain] and [B-Gain].
	R-Gain	White Balance Manual	–	Use the level bar to adjust the [R-Gain] for the camera image. Use [↑] or [↓] to increase or decrease the red color.
	B-Gain	White Balance Manual	–	Use the level bar to adjust the [B-Gain] for the camera image. Use [↑] or [↓] to increase or decrease the blue color.

* The “✓” symbol indicates the factory settings.

Icon	Name	Conditions	Selection Item	Function
	Image Mode		Text1 ✓	To clearly reproduce black & white subjects such as characters and lines. Use this when shooting materials such as documents or text based data. The effect grows stronger as the number is increased.
			Text2	
			Text3	
			Graphics1	To clearly reproduce color subjects. Use this when shooting materials such as color figures and photo based data.
			Graphics2	At times it is easier to view images when using a DLP projector.
	Edge Effect	Image Mode Graphics1	Low ✓	Emphasizes the outline of images making them crisper and clearer.
			Middle	
			High	
	Gamma	Image Mode Graphics1	Low	Changes the gradation of the image. (The effect is increased in the order Low, Middle, and High.)
			Middle ✓	
			High	
	Image Rotation		Off ✓	Turn ON to rotate the camera image by 180°.
			On	
	Color/B&W		Color ✓	To output a color camera image.
			B&W	To output a black & white camera image. To make the image easier to view, select this when shooting black & white documents etc.
	Posi/Nega		Posi ✓	To output a positive camera image.
			Nega	To output a negative camera image.
	Back			To return to the top menu.

* The "✓" symbol indicates the factory settings.

■ Function setting menu

Icon	Name	Selection Item	Function
	USB Mode	Mass Storage (*)	After connecting to a PC via a USB cable, data on the SD card loaded in this device can be sent to the PC.
		Application ✓ (*)	After connecting to a PC via a USB cable, it is possible to take control of this device and import images by PC.
	Flickerless	60Hz (*)	To reduce fluorescent lamp flickering due to the power supply frequency. Select the same value as used for the power supply frequency.
		50Hz (*)	
	Video Format	NTSC (*)	Video is output using the NTSC system.
		PAL (*)	Video is output using the PAL system.
	Highlight	Darkness –	To set the darkness of the masked section using the level bar, except for when using the Highlight display.
		Size –	To set the size of the Highlight display.
	Mask	Darkness –	To set the darkness of the masked section using the level bar.
	Scroll	x2 ✓	To set the digital zoom magnification for scroll display to 2x, 3x, or 4x.
		x3	
		x4	
	Preset	1	To store preset settings in the memory of the selected number.
		2	
		3	
		Power On	The preset settings stored here are automatically called the next time the power is turned on.
		Exit	Exits without saving settings.





* The “✓” symbol indicates the factory settings.

* The factory settings for Flicker Correction and Video Format differ depending on the region.

[North America Specifications]
Flicker Correction - 60Hz, Video Format - NTSC
[European Specifications]
Flicker Correction - 50Hz, Video Format - PAL

Note

- Selecting [Power On] or [Default] from [Call] provides the factory settings when the power is turned on. However, for items with (*) in the [Selection Item] column, the last status set is maintained.

Icon	Name	Selection Item	Function
	Call	1	To call the setting saved in the memory of the selected number.
		2	
		3	
		Default	Current settings are returned to the Default status. (*)
		Power On	Current settings are returned to the Power On status. (*)
Exit	Exits without calling settings.		
	Guide	On ✓	When turned on, the device's operating status and an explanation of the icons is displayed on the screen.
		Off	
	Language	Japanese (*)	Changes the OSD menu language to Japanese.
		English ✓ (*)	Changes the OSD menu language to English.
	RESOLUTION (Change the resolution)	SXGA ✓ (*)	Changes DVI and analog RGB output resolution to SXGA.
		720p 60Hz (*)	Changes DVI and analog RGB output resolution to 720p 60Hz.
		720p 50Hz (*)	Changes DVI and analog RGB output resolution to 720p 50Hz.
	Back		To return to the OSD menu display top menu.

* The "✓" symbol indicates the factory settings.





Note

- Selecting [Power On] or [Default] from [Call] provides the factory settings when the power is turned on. However, for items with (*) in the [Selection Item] column, the last status set is maintained.

■ SD mode OSD menu





After using Image select to change the output image to SD mode, press the "MENU" button to display the OSD menu. 

■ OSD top menu

Icon	Name	Selection Item	Function
	SD	SD settings menu	To display the setting menu for SD images.
	Slide Show	Slide Show settings menu	To display the setting menu for Slide Show.
	Back	–	Hides the OSD menu display.

■ SD menu

On this menu, when any item except for [Back] is selected, a [Yes] or [No] confirmation message is displayed. Select [Yes] to perform the operation, or [No] to cancel.

Icon	Name	Selection Item	Function
	Delete	Current	To delete the image currently displayed. (Locked images cannot be deleted.)
		All	To delete all images stored on the SD card. (Locked images cannot be deleted.)
		Exit	Exit without deleting anything.
	Lock	Current	To lock the image currently displayed. (Locked images cannot be deleted.)
		All	To lock all images stored on the SD card. (Locked images cannot be deleted.)
		Exit	Exit without locking anything.
	Unlock	Current	To unlock the image currently being displayed.
		All	To unlock all images stored on the SD card.
		Exit	Exit without unlocking anything.
	Format Media		To format an SD card. When this item is selected, a confirmation message is displayed. Select [Yes] to format or [No] to cancel. When formatting, all of the data on the SD card, including locked images, are deleted. Check before formatting the card.
	Back		To return to the OSD menu display top menu.

■ Slide show menu

Icon	Name	Selection Item	Function
	Start Slide Show		To start a slide show.
	Interval	5sec ✓	The image changes at the interval set when a slide show is performed.
		10sec	
		15sec	
		30sec	
	Select	All ✓	To use all images stored on the SD card for the slide show.
		Locked Only	To use only locked images from the images stored on the SD card for the slide show.
	Repeat	Off ✓	The slide show is only shown once.
		On	The slide show is repeated.
	Order	Forward ✓	To give a slide show in ascending order of serial No.
		Backward	To give a slide show in descending order of serial No.
	Back		To return to the OSD menu display top menu.

* The "✓" symbol indicates the factory settings.

2 SETTING UP

Setting Up

- 1 Raise the camera column. The lamp column is raised at the same time.

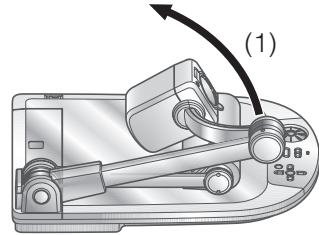

- 2 Rotate the camera head.

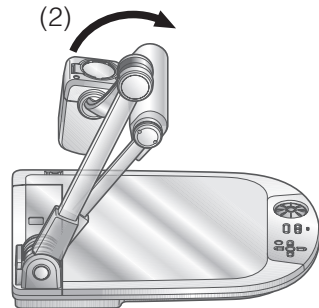

- 3 Adjust the lamp column and lamp head to a suitable position, as shown in the illustration on the right.

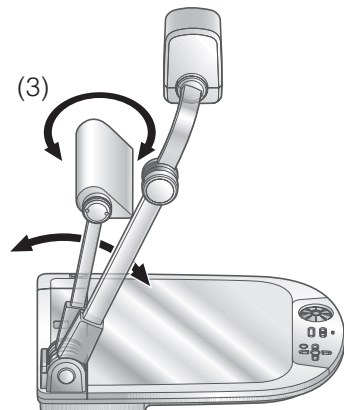

- 4 Connect the analog RGB cable to the [RGB OUT] terminal and connect the AC adapter's DC plug to the [DC IN 12V] terminal. (Connecting the AC Adapter and Video Cable. P.98)

- 5 Turn on the projector.

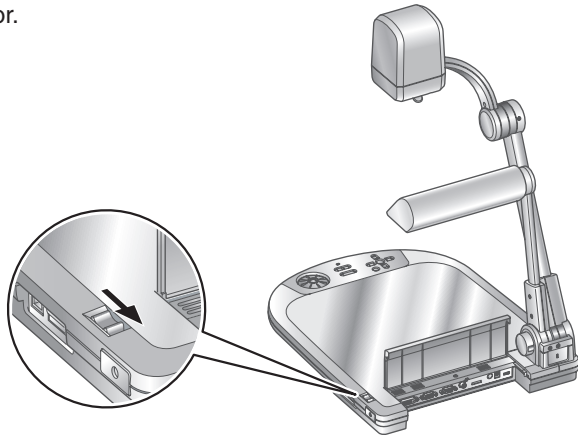
**Note**

- When using this unit, be sure to adjust the lamp column and the lamp head to a suitable position to allow easy operation.
- Be careful not to catch your fingers etc. when raising or lowering the column.

Connecting the AC Adapter and Video Cable

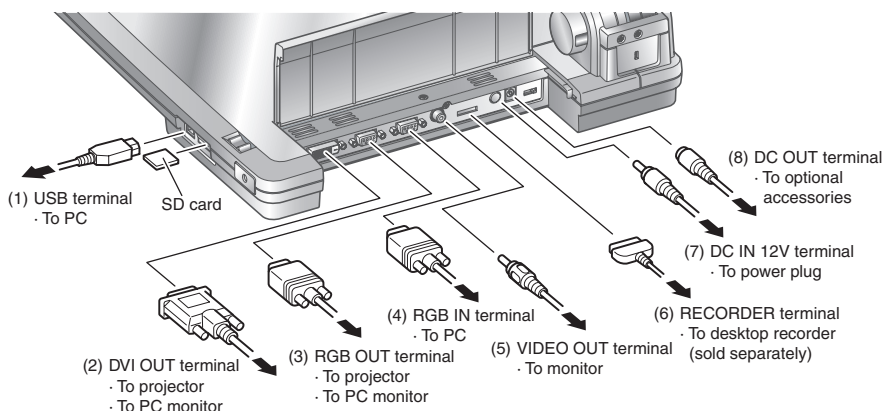

Note

- To protect the unit and connected peripheral devices, turn off all devices.
- When plugging in or unplugging the connector cable, hold the plug of the cable.

(1) Connecting to the PC with a USB cable

Connect the USB cable to the [USB] terminal on the side panel.

Note

- We recommend using a USB 2.0 compliant USB cable.
- If you plug into a USB connector with the power on, the PC may not recognize this device.
- Depending on the USB environment used by the PC or peripheral equipment using the USB 2.0 compliant cable, image transfer may be disrupted.
- Operation is not guaranteed for all environments.

(2) Connecting to the unit with a DVI input terminal equipped

Connect the supplied DVI cable to the [DVI OUT] terminal on the rear panel.

(3) Connecting to the unit with analog RGB input terminal equipped

Connect the supplied analog RGB cable to the [RGB OUT] terminal on the rear panel.

- The display position may be displaced from the center of the screen. In such a case, adjust the horizontal and vertical positions manually from the connected device.
- Vertical stripes may appear on the projector or PC monitor screen. This can be mitigated by manually adjusting the dot clock from the connected device of the unit with analog RGB output terminal equipped.

(4) Connecting to the unit with analog RGB output terminal equipped

Connect the supplied or commercially-available analog RGB cable to the [RGB IN] terminal on the rear panel.



- When using a laptop PC with external output mode switching, set the laptop PC side to the external output mode after pushing the manual operation button [PC] of this equipment.

■ Specifications of the analog RGB input terminal of this product

Signal allocation

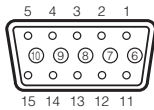

DSUB 15P shrink terminal (Female)

Video signal: Analog 0.7V (p-p) with 75Ω terminated

Horizontal synchronized signal: TTL level (Positive/negative polarity)

Vertical synchronized signal: TTL level (Positive/negative polarity)

Pin assignment

Pin No.	Name
1	Video signal (Red)
2	Video signal (Green)
3	Video signal (Blue)
4	N.C
5	GND

Pin No.	Name
6	GND (Red)
7	GND (Green)
8	GND (Blue)
9	N.C
10	GND
11	GND
12	N.C

Pin No.	Name
13	Horizontal synchronized signal
14	Vertical synchronized signal
15	N.C

(5) Connecting to the unit with a composite video input terminal equipped

Connect an RCA pin plug video cable to the [VIDEO OUT] terminal on the rear panel.

(6) Connecting the desktop recorder

Connect the optional desktop recorder to the main unit with a dedicated cable.

(7) Connecting the AC adapter

Connect the DC plug of the supplied AC adapter to the [DC IN 12V] terminal on the rear panel before inserting the AC adapter in an outlet.

(8) Connecting the optional Light Box

Connect the optional Light Box to the main unit with a dedicated cable. Do not connect any other device. Malfunctions may result.



Note

- Only one image can be output at a time; either [RGB OUT] and [DVI OUT] or [VIDEO OUT]. For more information on switching the image output, refer to "RESOLUTION/VIDEO" (Change Resolution Switch) [P.81](#)
- To protect the unit and peripheral devices, unplug the power plug and the AC adapter, and turn off all other devices before connecting the video cable.
- When plugging in or unplugging the power plug, the AC adapter, or video cable, hold the plug of the cable.

3 STORING

Storing

- 1 Rotate the lamp head and the lamp column and fold them down onto the stage as shown in the illustration on the right.



Note

- Before storing the main unit, be sure to turn the power off.

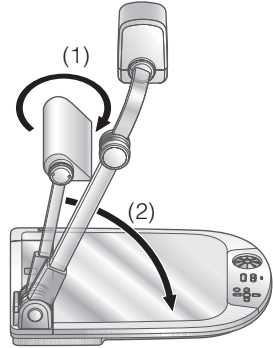

- 2 Rotate the camera head and the camera column and fold them down.

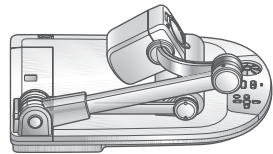
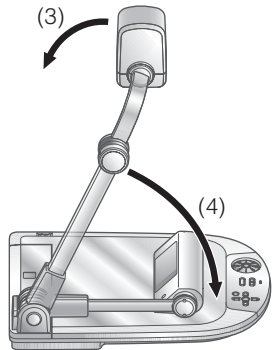

4 OPERATION PROCEDURE

Presentation Using Printed Materials, etc.

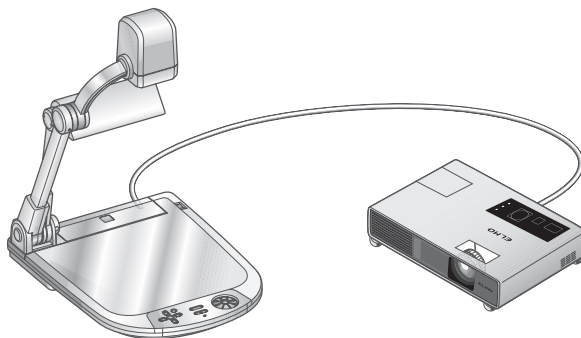

■ Setting the main unit

Set the main unit as shown in the figure above. Then connect it to a projector or a PC monitor, and turn on the power for the main unit. **P.98**

■ Lamp positioning



While watching the screen, adjust the angle of the lamp column and lamp head so that light covers the stage evenly. Pointing the light emitting part of the lamp head straight down allows the illumination to cover the stage evenly.



Note

- Depending on the position of the lamp, the camera column's shadow may fall across the screen. **P.117**

■ Adjusting the size

Place an object on the stage and adjust the zoom dial on the front panel or the zoom buttons [ / ] on the remote control so the part you want to shoot fits the screen size.

P.113

■ Adjusting the focus

In normal AF mode, the focus is automatically adjusted. In One-shot AF mode, the focus is adjusted by pressing the [AF] button on the operating panel or on the remote control.

P.114

■ Adjusting the brightness

Press the [BRIGHTNESS ] / [BRIGHTNESS ] buttons on the front panel or on the remote control to adjust the image brightness. **P.118**

■ Turning the illumination lamp ON/OFF

Press the Illumination lamp button on the unit to switch between ON and OFF.



- Before connecting the main unit to other devices, be sure to turn off the power for all of the devices.
- When copying B&W characters or documents etc., use [Text1] to [Text3] from the OSD (Camera image) as the image mode.



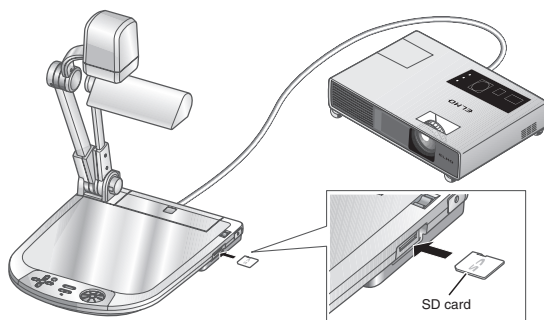

A better image may be produced by selecting Graphics1 mode with DLP projector.

- When connected to a DLP projector, select the image mode according to the displayed image, as both text and photos can be beautifully reproduced by switching to Graphics2 mode.





Presentation Using an SD Card (Commercially-available)



Note



- Before starting, insert a commercially-available SD card into the SD card slot on the side panel. Push the card again to remove the SD card.
- Insert the SD card with the label facing up. Forcing it into the slot in the wrong orientation may cause a malfunction.
- Before loading or unloading the SD card or turning the power off, be sure to select the camera image by pressing the camera button  on the operating panel, and confirm that the output image has been switched to camera image. Otherwise, the SD card contents could be damaged or the camera could malfunction.
- The SD card is composed of parts vulnerable to static electricity. Therefore, due to static electricity, the SD card could malfunction or its contents could be destroyed. When handling the SD card, take care to avoid static electricity.
- You may not be able to display image data other than that saved in this product or converted using the conversion function of the software supplied. Also, images of 7MBs or more cannot be displayed.
- When displaying image data in an unsupported format,  or  is displayed on the output screen.
- If you try displaying image data on an SD card without inserting an SD card, a black screen with the message  is displayed.
- After using the SD card, do not leave it inserted in this product; be sure to remove it.
- We recommend using SD cards (512MB, 1GB, and 2GB) made by Panasonic, and SDHC cards (up to 4GB) made by Panasonic.
The resolution for the stored images is 1280x1024 (for SXGA output), 1280x800 (for WXGA output), and 1280x960 (for XGA output).
This product can store up to 2048 images.
- ELMO is not liable for any damage caused by the loss of the data in the SD card or passive damage.
- When an SD card is inserted, "Card Reading" is displayed on the screen, and to allow this device to check the contents of the SD card, it may take some time between inserting the card and the JPEGs being displayed and captured.
In that case, please wait a short time before performing any of the operations mentioned above.
- When an SD card is inserted and then the power to the main unit is turned on, it may take a while before operations can be performed on the main unit.
- Please wait a short time until the power switch on the main unit lights blue before performing any operations.

■ Saving the image

- (1) Press the  button on the operating panel or the  button on the remote control to switch the output image to the camera image.
- (2) Make sure that the OSD is not displayed, and then press the  button on the operating panel or on the remote control.
- (3) Saving begins when the  mark is displayed on the screen. Saving is complete when the symbol disappears.







Note

- Only optically zoomed images may be saved, digitally zoomed images will revert back the maximum optical zoom prior to saving.
- Saved images will not be Time/Date stamped.
- Please confirm images are saved correctly to the SD card or PC.
ELMO is not liable for lost images or failure to capture images.
- The  mark is only displayed on the screen when [Function Setting] → [Guide] is set to ON from the Camera OSD menu.
- When the SD card is write-protected, images cannot be saved in the SD card.
- If the SD card is full when recording, an  mark is displayed on the screen. Delete any unnecessary images or use another SD card.
- Never remove the SD card while it is reading or writing data. This may cause malfunctions to occur.
- Do not turn off the power to this product while the SD card is reading or writing data. This may cause malfunctions to occur.

■ Displaying the image

There are two display modes for SD images. You can use Single display to display one image only, or 4x4 display to display 16 images.

● Single display

- (1) Make sure that the OSD is not displayed, and then press the  button on the operating panel or on the remote control. The output image changes to SD mode, and the images stored on the SD card are displayed as single images.
- (2) Make sure that the OSD is not displayed, and then press the  button on the operating panel or the  button on the remote control to change to the next image. Press the  button on the operating panel or the  button on the remote control to return to the previous image.
- (3) You can zoom in or out of the image being displayed by using the zoom dial on the main unit, and you can reset zoom in/out by using the AF button on the main unit.



Note

- When an SD image is enlarged, the Scroll function cannot be used. If you want to use the Scroll function, press the AF button to reset the image enlargement, and then scroll.

- Changing display mode

- (1) During Single display in SD Mode, make sure that the OSD is not displayed, and then press the [] button on the operating panel or the [AF ●] button on the remote control to change the display from Single display to 4x4 display.
- (2) Press the [] and [] buttons on the operating panel or the [] and [] buttons on the remote control to move the image selection cursor.
- (3) Press the [] button on the operating panel or the [AF ●] button on the remote control to display the image selected with the image selection cursor in Single display.

- Deleting, locking, and unlocking images

- (1) Make sure that the OSD is not displayed, and then press the [] button on the front panel or on the remote control. The output image changes to SD mode, and the images stored on the SD card are displayed as single images. When you want to work in 4x4 display, press the [] button on the operating panel or the [AF ●] button on the remote control to change to 4x4 display.
- (2) Use the [] / [] buttons on the operating panel to select the image you want to delete.
In Single display, the image you want to delete is displayed. In 4x4 display, use the image selection cursor to select the image you want to delete.
- (3) Press the [MENU] button on the operating panel to display the SD Mode OSD menu.

- Deleting images

From the OSD menu, select [SD] → [Delete].

To delete the image currently selected, select [Current]. To delete all images, select [All].

- Locking images

From the OSD menu, select [SD] → [Lock].

To lock the image currently selected, select [Current]. To lock all images, select [All].

- Unlocking images

From the OSD menu, select [SD] → [Unlock].



To unlock the image currently selected, select [Current]. To unlock all images, select [All].

■ Formatting the SD card

When you need to format the SD card, insert the SD card into this product, and execute formatting.

- (1) Make sure that the OSD is not displayed, and then press the [] button on the operating panel or on the remote control to switch the output image to SD mode.
- (2) Press the [MENU] button on the operating panel to display the SD Mode OSD menu.
- (3) From the OSD menu, select [SD] → [Format Media].
- (4) Select [Yes] to start formatting. (If you do not want to format, select [No].)

■ Slide Show

- (1) Make sure that the OSD is not displayed, and then press the [] button on the operating panel or on the remote control to switch the output image to SD mode.
- (2) Press the [MENU] button on the operating panel to display the SD Mode OSD menu.
- (3) From the OSD menu, select [Slide Show] → [Start Slide Show].
- (4) When any button (excluding the [POWER ] button) on the operating panel or the remote control is pressed, the slide show stops.
 - You can set Interval, Repeat, or Order from the [Slide Show] menu of the OSD.



Note

- When [Mass Storage] is set from [Function Setting] → [USB Mode] on the OSD menu and the product is connected to a PC, you cannot delete, lock, or unlock SD images or format an SD card.
- Do not turn off the power while formatting the SD card.
- When formatting the SD card, proceed to the next operation after confirming that [] has appeared.
- Do not format the card on any other machine. If you do format the card using a PC, format it again using this unit.

Transferring Images From the SD Card to a USB-connected PC

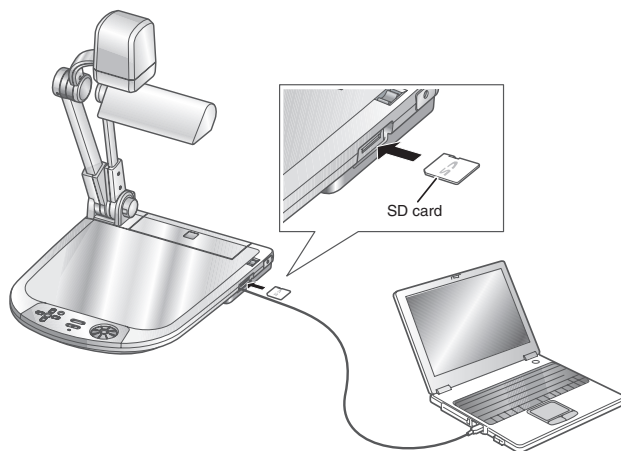

Note

- Set [USB Mode] to [Mass Storage] on the OSD Camera settings menu.
- Insert the SD card with the label facing up. Forcing it into the slot in the wrong orientation may cause a malfunction.

When this product is connected to a PC via USB, image data on the SD card can be transferred to the PC.

The Operating System (OS) for the connected PC should be Microsoft Windows 2000 (SP4 or later)/XP (SP2 or later)/Vista.

- (1) Turn on the power supply to this product and to the PC.
- (2) Connect this product to the PC with the supplied USB cable.

Note

- When this product is connected to the PC for the first time, the required drivers are installed automatically using the plug-and-play function of Windows. From the second time and thereafter, the drivers are no longer installed.

(3) This product is recognized as a removable disk. You can view the image data on an SD card on the PC's viewer software.

- The image data is stored in JPEG format in the following folders:

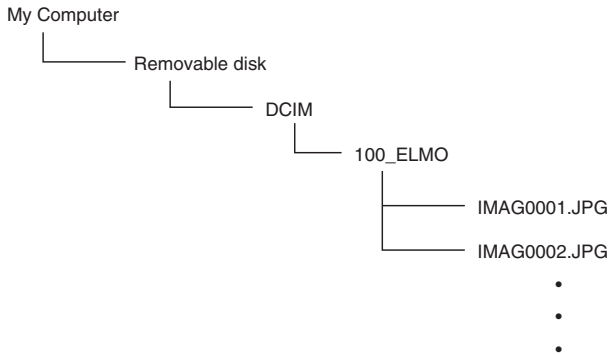

Note

- An SD card set in this product cannot be saved, deleted, locked, unlocked, or formatted with image data from the PC.
- Image data cannot be recorded with the correct date and time.
- When the front panel or the remote control is in operation, do not connect or disconnect the USB cable, as this could cause malfunctions to occur.
- Do not switch [USB Mode] on the OSD when this product is in USB-connection.
- We recommend using a USB 2.0 compliant USB cable.
- Depending on the USB environment used by the PC or peripheral equipment using the USB 2.0 compliant cable, image transfer may be disrupted.
- Operation is not guaranteed for all environments.
- When USB Mode has been set to [Mass Storage] and a USB cable has been connected to the PC, an SD card cannot be deleted, locked, unlocked, formatted, and saved with image data on this device.

Presentation Using the Supplied Software with a USB-connected PC

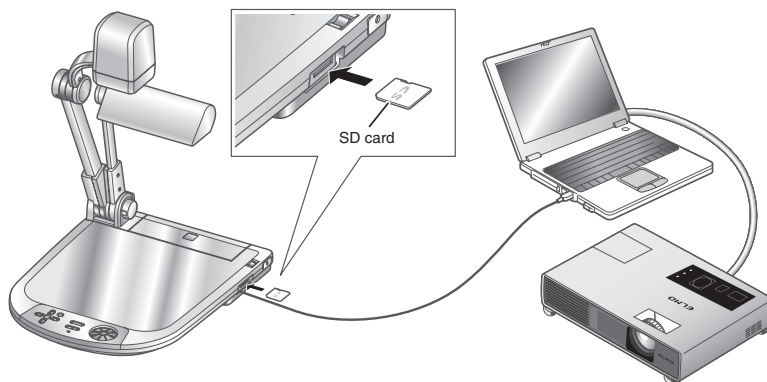

Note

- Set USB Mode to Application on the OSD.

“Image Mate” can be found on the supplied CD-ROM.

The “Image Mate” and TWAIN driver “Image Mate TWAIN” software for controlling this device can be found on the CD-ROM and allows you to perform the following functions.

- Transfer moving/still images to the PC
- Operate this product from the PC

For information such as PC hardware requirements, OS type, software guides, and the “Image Mate” installation manual, see the “HELP folder” on the CD-ROM.



Note

- When the front panel or the remote control is in operation, do not connect or disconnect the USB cable, as this could cause malfunctions to occur.
- We recommend using a USB 2.0 compliant USB cable.
- Depending on the USB environment used by the PC or peripheral equipment using the USB 2.0 compliant cable, image transfer may be disrupted.
- Operation is not guaranteed for all environments.

Shooting Off the Stage

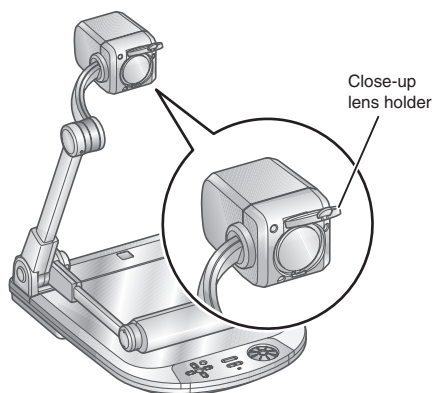

<Shooting forward>

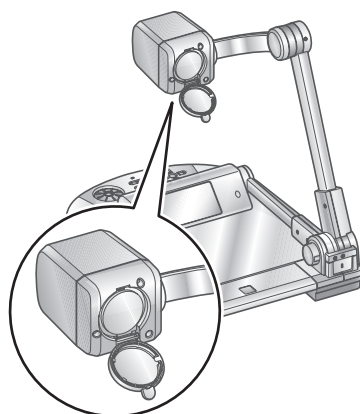

<Shooting downward>

When the camera head section is set horizontally, you can shoot walls, distant views, etc. If the subject is far away, open the close-up lens holder forward.



Note

- To shoot an object in front of the main unit, set the OSD to rotate the image by 180°.
- Shooting range when the close-up lens holder is open:
 - TELE : 500mm (19 $\frac{3}{4}$ in) to ∞ from the zoom lens
 - WIDE : 100mm (3 $\frac{15}{16}$ in) to ∞ from the zoom lens

Presentation Using Film

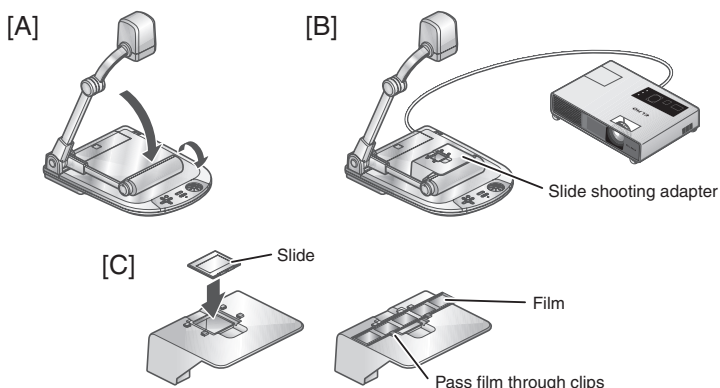

■ Setting the main unit

After folding the lamp onto the main unit as shown in Figure A, and then connecting a projector or PC monitor, turn on the power.

■ Setting the slide shooting adapter

Cover and place the supplied slide shooting adapter on the lamp head, and adjust the position while watching the screen, so that the opening of the slide shooting adapter points to the center of the screen. (Figure B)

■ Adjusting the size

Set the film or slides in the slide shooting adapter as shown in Figure C, and then use the zoom buttons [\oplus / \ominus] on the operating panel or the remote control to adjust the slide to fit the screen size.

■ Adjusting the focus

In normal AF mode, the focus is automatically adjusted. In One-shot AF mode, the focus is adjusted by pressing the [AF] button on the operating panel or on the remote control.

■ Adjusting the brightness

If the screen is too bright or too dark, you can adjust the brightness from [Brightness] on the OSD setting menu or by using the [BRIGHTNESS \odot] / [BRIGHTNESS \ominus] buttons on the remote control.



Note

- Depending on the film, change the display setting from the [**PN**Posi/Nega] OSD setting menu to [Posi] or [Nega], or use the [Posi/Nega] button on the remote control.
- If you feel that the screen is too dark even after adjusting the brightness, you can improve the brightness by placing a white sheet of paper on the stage and then attaching the slide shooting adapter.

5 VARIOUS FUNCTIONS AND OPERATIONS

Zoom

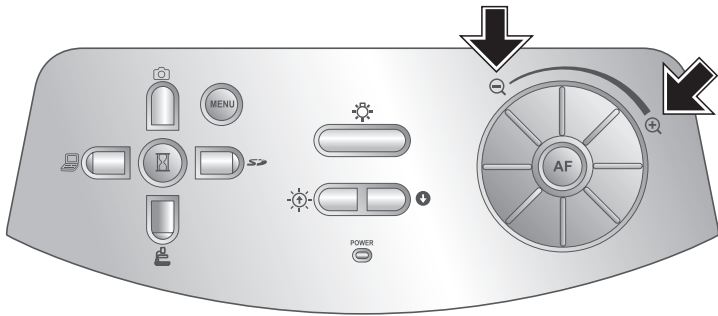

The display range of the document can be adjusted by rotating the zoom dial on the main unit [🔍, 🔍] or by pressing the zoom buttons on the remote control [🔍, 🔍].

- WIDE (ZOOM-OUT 🔍) : Object can be shown in small size.
- TELE (ZOOM-IN 🔍) : Object can be shown in large size.

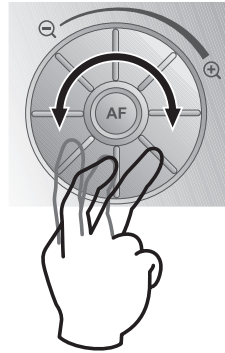

Note

- Zoom ratio: Optical 16x, Digital 8x
- Within the digital zoom range, the image quality is degraded.
- In SD mode, SD images can be digitally zoomed (enlarged/reduced).



Focus

■ Auto Focus (AF)

Normal AF mode or One-shot AF mode can be selected on the main unit.



Note

- The objects listed below may not be brought into focus by Auto Focus. In such cases, use the manual focus.
 - Low contrast objects
 - Objects with fine repeated patterns, such as lateral stripes and crisscross stripes
 - Objects glittering or reflecting strong light
 - Objects on the far side of glass which is wet or dirty
 - Objects with a bright background or excessive contrast
 - Objects that are entirely dark
 - Objects in motion
- In normal AF mode, the focus is adjusted constantly.
 - To fix the focus, select One-shot AF mode or use manual focus.
- Focus range
 - With close-up lens
 - TELE: 250mm ($9\frac{13}{16}$ in) to 440mm ($17\frac{5}{16}$ in) from the close-up lens
 - WIDE: 90mm ($3\frac{1}{2}$ in) to 440mm ($17\frac{5}{16}$ in) from the close-up lens
 - Without close-up lens
 - TELE: 500mm ($19\frac{3}{4}$ in) to ∞ from the zoom lens
 - WIDE: 100mm ($3\frac{15}{16}$ in) to ∞ from the zoom lens
- In SD mode, digital zoom settings for SD images can be reset.

■ Normal AF mode



The focus is adjusted constantly and the camera focuses on objects automatically.
(factory setting)

■ One-shot AF mode

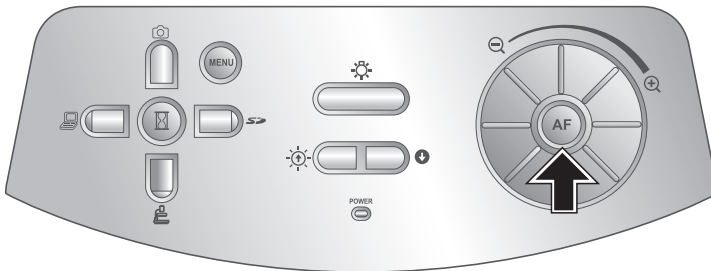
You can automatically adjust the focus by selecting [AF Mode] → [Shot] from the OSD menu or pressing the [AF] button on the operation panel or the remote control. Once the camera has been focused, AF is released and the focus is fixed in that position.



Manual focus

You can change the focus position by pressing the  and  buttons on the main unit after selecting [Focus] from the OSD menu.

Use this function (manual focus) to focus on any part of a 3-D object.

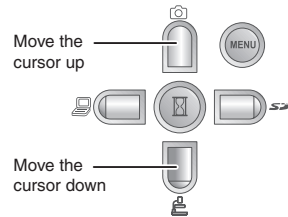
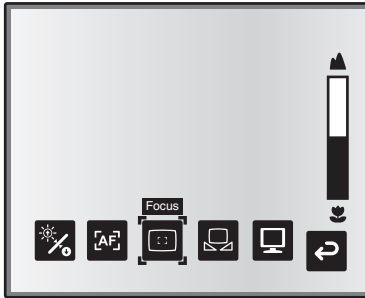

Illumination

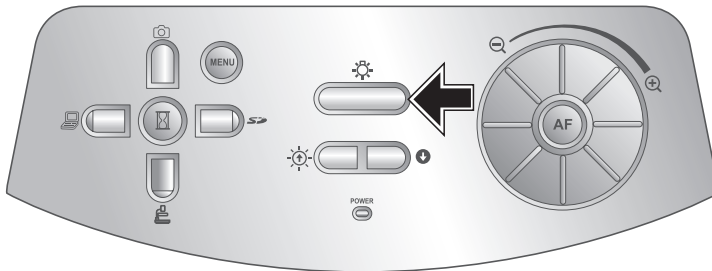

The illumination lamp turns on when you press [☀️] on the operating panel. It turns on or off each time the [☀️] button is pressed.

When the illumination lamp does not provide enough light on the stage's surface, or when shooting 3-D objects, it renders a high quality, vivid image.

■ Lamp positioning

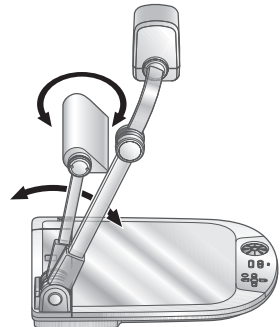

While watching the screen, adjust the angle of the lamp column and lamp head so that light covers the stage evenly. Pointing the light emitting part of the lamp head straight down allows the illumination to cover the stage evenly.



Note

- Depending on the position of the lamp, the camera column's shadow may fall across the screen.
- Do not look into the lamp section. This could damage your eyesight.
- The brightness deteriorates after using the lamp (LED illumination) for a long time.
- When the lamp is on, the temperature increases. Do not touch the lamp section.

Adjusting the Brightness

Press the [BRIGHTNESS ] or [BRIGHTNESS ] button on the operating panel or on the remote control to adjust image brightness. The following two adjustment modes can be set by selecting [Brightness] from the OSD menu.

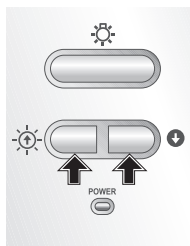

■ Automatic brightness adjustment

([Brightness] → [Auto] in the OSD)

The brightness of the image changes automatically according to the brightness of the object.

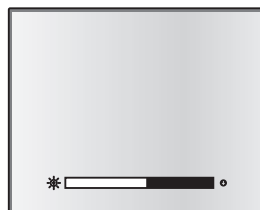



■ Manual brightness adjustment

([Brightness] → [Manual] in the OSD)

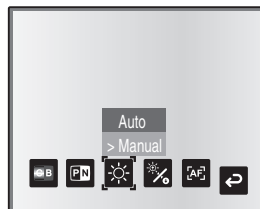
The brightness of the image is fixed to the specified level.



Note





- Factory setting is set to [Auto].
- Manual adjustment fixes the brightness and does not adjust to changes in brightness of the object.
- By setting [Guide] to [On] in the OSD menu, the setting details are displayed on the screen.
- To go back to the factory settings, press the [BRIGHTNESS ] and [BRIGHTNESS ] buttons on the front panel at the same time, or set [Reset Brightness] from the OSD menu.
- In places where the object is exposed to bright sunlight (e.g. near a window), or extremely bright lights, the brightness of the screen may not dim sufficiently, even when the [BRIGHTNESS ] button is pressed.

In such cases, adjust the amount of light by closing the curtains or moving the source of the light.

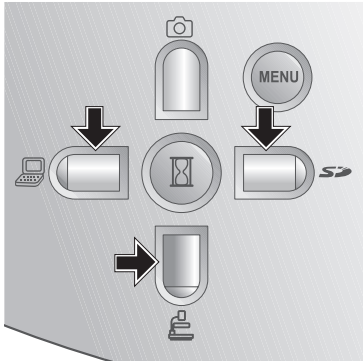



Image Selection



You can switch to camera image when you press the [] button on the operating panel or the [] button on the remote control, switch to the image input to the analog RGB input terminal [RGB IN] by pressing the [] button on the operating panel or on the remote control, and switch to images saved on the SD card by pressing the [] button on the operating panel or on the remote control.

By connecting PCs and other devices to the analog RGB input terminal [RGB IN], you can switch output images without disconnecting cables.

Note

- The front panel and remote control [] buttons cannot be used when the RGB/VIDEO switch is set to VIDEO.
- When using a laptop PC equipped with external output selection, set the output mode of the PC to “external” after pressing the [] button on the operating panel or the remote control.
- Enters [CAMERA] mode when the output is [RGB OUT] and [VIDEO] is set for [PC] mode.

White Balance

■ How to use [Auto]

Adjust the white balance automatically according to the color status of the document.

Factory setting: [Auto]

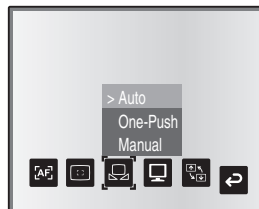

■ How to use [One-Push]

To be used when the color balance of the image is lost.

Shoot a sheet of white paper and then set [White Balance]

→ [One-Push] from the OSD menu. The white balance for the color temperature is then fixed.

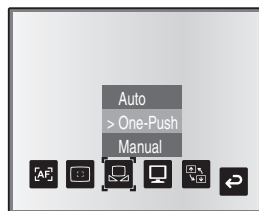

■ How to use [Manual]

Setting [White Balance] → [Manual] from the OSD menu fixes the white balance to allow [R-Gain] and [B-Gain] for the OSD to be adjustable.

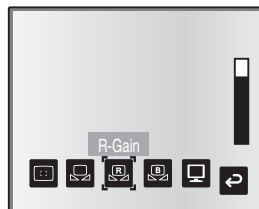
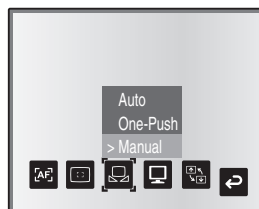

Note

- The color temperature that can be automatically followed ranges from approx. 3000K to 8000K.
- By setting [Guide] to [On] in the OSD menu, the setting details are displayed on the screen.

Save/call Settings

The operation status of the unit can be saved to or called from the memory. The unit saves 4 conditions (1 to 3 and Power ON) under the following storage conditions.

- Current zoom ratio (The range of the optical zoom)
- Brightness
- Image mode settings
- Edge enhancement (in Graphics mode)
- Gamma value setting (in Graphics mode)
- Status of image rotation
- Status of white balance
- Illumination lamp settings (only for ON setting)
- Intensity of red color (when selecting [White Balance] → [Manual])
- Intensity of blue color (when selecting [White Balance] → [Manual])
- Posi/nega settings
- Color/B&W switch settings
- AF mode



Note

- The saved conditions are saved even if the power is turned off.

■ How to save settings

Select [Preset] → [1] to [3] from the OSD menu to save current unit configuration as the selected number. (Excluding USB Mode settings)

Select [Preset] → [Power On] from the OSD menu to save the settings that are called when the power is turned on for the main unit. (Excluding USB Mode settings)

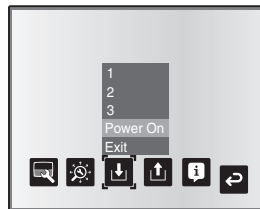

Note

- Only [Power ON] can be saved for the illumination lamp settings.
- Zoomed areas cannot be saved during digital zooming. However, when saving the settings in digital zoom mode, when the zoom size of view is at the maximum position [ZOOM-IN , the area within the range of the optical zoom can be saved.

■ How to call settings

Select [Call] → [1] to [3] from the OSD menu to call the settings for the selected number.

Select [Call] → [Power On] from the OSD menu to call the settings for when the power is turned on.

Select [Call] → [Default] from the OSD menu to call the factory settings. (Excluding USB Mode settings)

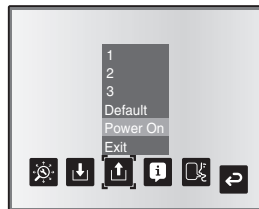
**Note**

- Unable to operate the zoom dial on the front operation panel or the remote control while calling settings.

Highlight Function

If you want to draw attention to a particular section of the output image, you can use Highlight display.

■ Highlight settings

From the Camera Mode OSD Menu, select [Function Setting] → [Highlight]. When [Darkness] is selected, the level bar is displayed, and you can then set the darkness for the areas outside the highlighted section with the [CAM] and [COPY] buttons on the operating panel. Also, when you select [Size], you can adjust the size of the highlighted section vertically by using the [CAM] and [COPY] buttons on the operating panel, and you can adjust the size horizontally using the [COPY] and [SD] buttons.

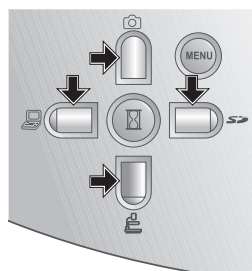

■ Highlight operations

When you press the [] button on the remote control while the output image is Camera Image or SD Mode, the highlight display uses the darkness and size set previously.

You can move the highlighted area using the [▲], [▼], [◀], and [▶] buttons on the remote control. The highlight display is cleared when you press the [] button on the remote control again.



Note

- The Highlight function cannot be used when the output image is PC.
- In the optical zoom range, the highlight size remains the same. In the digital zoom range, the highlight size expands and contracts depending on the magnification ratio.
- Cannot perform a capture of a highlighted image.
- When the highlight size is selected from the OSD menu, the highlight size currently displayed returns to the initial settings.

Mask Function

You can mask a section of the output image.

■ Mask settings

From the Camera Mode OSD Menu, select [Function Setting] → [Mask]. The level bar to set [Darkness] is displayed, and you can then set the darkness for the masked areas with the [CAMERA] and [MASK] buttons on the operating panel.

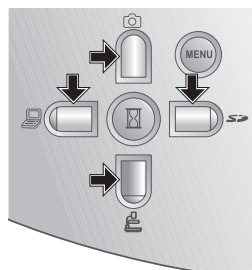

■ Mask operations

When you press the [MASK] button on the remote control while the output image is Camera Image or SD Mode, the mask display uses the darkness set previously.

You can move the masked area using the [▲], [▼], [◀], and [▶] buttons on the remote control.

The mask display is cleared when you press the [MASK] button on the remote control again.

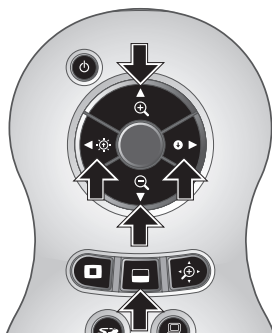

Note

- The mask function cannot be used when the output image is PC.
- In the optical zoom range, the mask size remains the same. In the digital zoom range, the mask size expands and contracts depending on the magnification ratio.
- Cannot mask the entire output image.

Scroll Function

The image expands to the digital zoom set previously, and the screen can be scrolled.

■ Digital zoom settings

From the Camera Mode OSD Menu, select [Function Setting] → [Scroll], and set the digital zoom ratio to x2, x3, or x4.

■ Scroll operations

When you press the [\oplus] button on the remote control while the output image is Camera Image or SD Mode, the image expands to the digital zoom set previously.

You can scroll the enlarged image by using the [▲], [▼], [◀], or [▶] buttons on the remote control. Digital zoom is canceled when you press the [\oplus] button on the remote control.

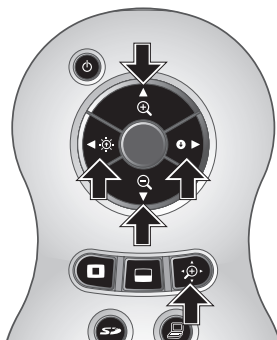

Note





- The scroll function cannot be used when the output image is PC.
- When digital zoom has already been performed from the zoom dial on the main unit or the zoom buttons on the remote control, digital zoom is released and the scroll function works at the magnification ratio currently set.
- Cannot use digital zoom while scrolling.
- Within the digital zoom range, the image quality is degraded.

PIP (Picture in Picture) Function

When you press this button, you can display a quarter-size still image on a live camera display.

■ PIP operations

If you press the  button on the remote control while the output image is Camera Image, a quarter-size still image is displayed at the bottom left of the screen.

By using the , , , and  buttons on the remote control, you can move the still image to the bottom left, top left, top right, and bottom right. PIP display is canceled when you press the  button on the remote control.

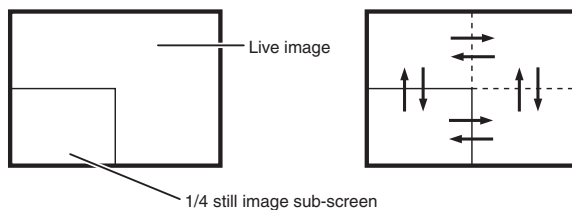

Note

- PIP can only be used when the output image is Camera image. It cannot be used during SD mode or PC mode.
- When the output image is digitally zoomed, the still screen is at the edge of the optical zoom image.
- Cannot use digital zoom while using PIP function.

Using a Desktop Recorder (Optional)

By connecting the optional desktop recorder to the main unit with a dedicated cable, you can record camera images from the main unit with the desktop recorder, and output video playback for the desktop recorder from the analog RGB output terminal of the main unit.

■ Connecting the desktop recorder

- (1) Turn off the power supply to the desktop recorder and to this product.
- (2) Connect this product to the desktop recorder using the cable supplied with the desktop recorder.
- (3) Turn on the power supply to the desktop recorder and to this product.

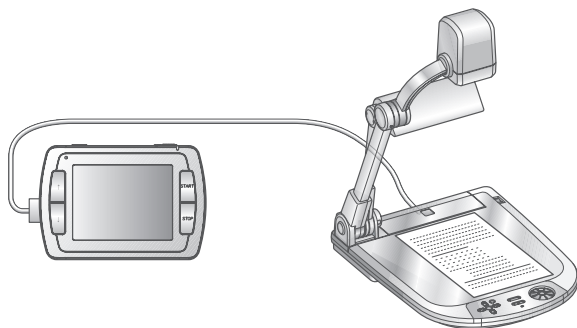

■ Operating the desktop recorder by remote control

- (1) Connect the desktop recorder to this product and press the [RECORD] button on the remote control.
- (2) Operate the desktop recorder by using the [↑], [↓], [←], [→], and [MENU] buttons on the remote control.

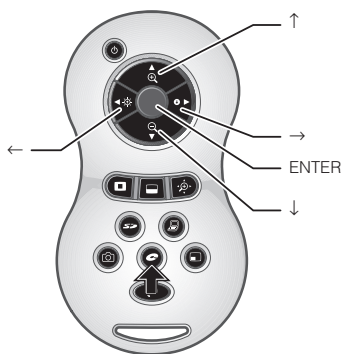

Note

- Refer to the manual for the optional desktop recorder for operating details.
- Cannot use the remote control while using the desktop recorder.

6 TROUBLE SHOOTING

Symptoms and Confirmation

Check the following items. If any abnormality is found, consult the dealer from whom you purchased this product or our nearest branch/office.

Symptom	Possible causes/countermeasures
No image is displayed.	<ul style="list-style-type: none"> • The cable is not correctly connected. • The AC adapter is disconnected from the wall outlet. • The AC adapter is disconnected from the power supply socket of the presenter. • The power is not on. (Blue lamp) • Zoom is set at the TELE side, displaying only the white/black part of the document. • If you turn the power on immediately after turning it off, the unit may not start. Wait for several seconds after turning the power off, and then turn it back on. • The slide switch is not set to the correct image output. In such a case, set the dip switch correctly by referring to “RESOLUTION/VIDEO (Change Resolution Switch)”. P.81
No image is displayed from the USB.	<ul style="list-style-type: none"> • No image is output from the USB during USB Mode (Mass Storage) or SD Mode. Check whether or not it is set to Mass Storage or SD mode. Switch the USB mode from Mass Storage to Application, referring to “Function Setting Menu”. When using SD mode, change the output image to Camera image. P.91
The image is out of focus.	<ul style="list-style-type: none"> • The document (object) is too close to the lens. • Some auto focus may be difficult to adjust. Focus on an image manually, referring to “Manual focus”. P.116
The output image is disarrayed.	<ul style="list-style-type: none"> • Is the video output system set to PAL? If it is set to PAL, and the product is connected to a monitor specially designed for an NTSC system, the video image may not be normally output, but be disarrayed or in black and white. Check if the video output system is set to PAL. • There are cases where the output image may be disarrayed while zooming using the digital zoom. However, this is not a malfunction.
The image is too dark.	<ul style="list-style-type: none"> • The intensity of the lighting is insufficient. Press the [BRIGHTNESS ⚙️] button on the front panel or on the remote control to adjust the brightness.
The image is striped.	<ul style="list-style-type: none"> • This may be interference fringes between dots of printed matter and TV scanning lines or CMOS pixels. Changing the projection range may mitigate the trouble. • Vertical stripes may appear on an LCD projector image. Manually adjusting the dot clock at the projector side may mitigate the trouble.

Symptom	Possible causes/countermeasures
Button operations are delayed or ineffective.	<ul style="list-style-type: none"> Is an operation that is overloading the product, such as continuously pressing a button, or performing another operation while pressing a button, being performed? Turn the power off, and then turn it on again.
Images on the SD card are not displayed.	<ul style="list-style-type: none"> Remove the SD card and then reinsert it after a few seconds.
The image does not move.	<ul style="list-style-type: none"> Camera image is set to [Pause]. Press the Pause button on the operating panel again to unpauses.
The remote control does not work.	<ul style="list-style-type: none"> Battery performance is reduced. Replace the batteries with new ones. The incorrect remote control is being used. Use the supplied remote control.
Cannot perform operations when the SD card is inserted.	<ul style="list-style-type: none"> The SD card is not being read correctly. Use it after performing the following 2 formatting operations. First, format the card using your PC. Second, format the card using the main unit.
The resolution does not change when setting the OSD to 720p.	<ul style="list-style-type: none"> Is RESOLUTION/VIDEO (the change resolution switch) set to SXGA? If the RESOLUTION/VIDEO is set to WXGA or XGA, output resolution does not change to 720p even after switching the resolution to 720p by OSD.
Does not start even when the power is turned on.	<ul style="list-style-type: none"> Is the SD card full? If the SD card is full and inserted when you start up, it may take some time to start.

About the lamp (LED lighting)

- The brightness of the lamp with which this product is equipped will degrade with long-term usage. If its brightness has been degraded greatly, we will replace the part for a charge. Consult the dealer from whom you purchased this product or our branch/office near your location.

About long-term usage of this product

- If this product is used for longer than the warranty period, its performance and quality may deteriorate due to the lifetime of its parts. In this case, we will replace the parts for a charge. Consult the dealer from whom you purchased this product or our nearest branch/office.

7 SPECIFICATIONS

■ General

Item	Specifications	
Power source	12VDC (AC adapter AC100 - 240V)	
Power consumption	20W (AC adapter included) 30W (AC adapter included when the DC OUT terminal is connected)	
Outside dimensions	W377 x D482 x H196mm (W14 $\frac{13}{16}$ x D19 x H7 $\frac{3}{4}$ in) (When folded)	
	W377 x D482 x H613mm (W14 $\frac{13}{16}$ x D19 x H24 $\frac{1}{8}$ in) (When set up)	
Weight	Approx. 4.5kg (9.9lbs) (Main body only)	
Input selection	Main/External	
Output terminal	DVI output	DVI-D 24P connector, female x1
	RGB output	Mini Dsub 15P connector, female x1
	Composite video output	RCA pin jack/75 Ω unbalanced x1 (NTSC/PAL)
Input terminal	RGB input	Mini Dsub 15P connector, female x1
Ext. control terminal	USB (2.0 compliant)	Type B receptacle x1
Memory interface	SD card slot x1	

■ Main camera

Item	Specifications
Lens	f=4.9mm to 78.4mm (16x zoom) f=2.7
Frame rate	Max. 30 frames/sec.
Shooting area	SXGA : Max. 405mm x 324mm Min. 30mm x 24mm HDTV : Max. 405mm x 223mm Min. 30mm x 17mm WXGA : Max. 405mm x 248mm Min. 30mm x 19mm XGA : Max. 405mm x 303mm Min. 30mm x 23mm
Limit of focus adjustment	With close-up lens TELE : 250mm (9 $\frac{13}{16}$ in) to 440mm (17 $\frac{5}{16}$ in) from the close-up lens WIDE : 90mm (3 $\frac{1}{2}$ in) to 440mm (17 $\frac{5}{16}$ in) from the close-up lens
	Without close-up lens TELE : 500mm (19 $\frac{3}{4}$ in) to ∞ from the close-up lens WIDE : 100mm (3 $\frac{15}{16}$ in) to ∞ from the close-up lens
Optical zoom	16x
Digital zoom	8x
Focus	Auto/Manual
Image pick-up element	1/3" CMOS
Total pixels	Horizontal 1384, Vertical 1076 ... Approx. 1,490,000 pixels

Item	Specifications	
Effective pixels	SXGA : Horizontal 1280, Vertical 1024 HDTV : Horizontal 1280, Vertical 720 WXGA : Horizontal 1280, Vertical 800 XGA : Horizontal 1280, Vertical 960	
Synchronized signal	Internal	
Resolution	Analog RGB Horizontal 800TV lines or more, Vertical 800TV lines or more Video output Horizontal 500TV lines or more	
DVI (DVI-D) output	TMDS data signal 0.5 V(p-p) 50 Ω (terminated)	SXGA : 1280 x 1024@60Hz VESA compliant Horizontal frequency : 63.981kHz Vertical frequency : 60.020Hz HDTV : 1280 x 720@60Hz HDTV compliant Horizontal frequency : 44.96kHz Vertical frequency : 60Hz HDTV : 1280 x 720@50Hz HDTV compliant Horizontal frequency : 37.5kHz Vertical frequency : 50kHz WXGA : 1280 x 800@60Hz VESA compliant Horizontal frequency : 49.306kHz Vertical frequency : 59.910Hz XGA : 1024 x 768@60Hz VESA compliant Horizontal frequency : 48.363kHz Vertical frequency : 60.004Hz
Analog RGB output	Analog RGB output 0.7 V(p-p) 75 Ω unbalanced Synchronized signal SXGA : Positive polarity HDTV : Negative polarity WXGA : Horizontal negative polarity and vertical positive polarity XGA : Negative polarity	
Composite video output	Compliant with NTSC/PAL	
White balance	Auto/One-Push/Manual	
Video output selection switch	Provided (NTSC/PAL)	
Brightness Control	Auto/Manual	
Posi/Nega conversion	Provided	
Color/B&W selection	Provided	
Image rotation	Provided (0°/180°)	
Mode	Text1/Text2/Text3/Graphics1/Graphics2	
Gamma setting	Provided (Only for Graphics mode)	
Edge Enhancement	Provided (Only for Graphics mode)	
Pause	Provided	
Image storage	Provided (SD card)	
Slide Show	Provided (SD image data)	

■ Illumination device

Illumination lamp	White LED
-------------------	-----------

■ Supplied Accessories

Name	Quantity
AC adapter	1
Power cord (1.5m)	1
RCA video cable (3m)	1
Analog RGB cable (Dsub 15P connector) (2m)	1
DVI cable	1
Remote control (infrared wireless type)	1
AAA batteries	2
Remote control strap	1
P10 user's guide	1
P10 warranty card	1
USB cable (1.8m)	1
Image Mate installation manual	1
Image Mate CD-ROM	1
Slide shooting adapter	1



Note

- Use pin plug for RCA pin in accordance with EIAJ RC-6703.
- The above specifications are subject to change without notice.

Trademarks

ELMO is a trademark of ELMO Co., Ltd.

VESA is the registered trademark of Video Electronics Standards Association.



SD logo is a trademark.

All other company/product names described in this manual are trademarks or registered trademarks of their respective companies.

ご注意

- スライド・書籍・写真等は個人で楽しむほかは、著作権法上、権利者に無断で録画できませんのでご注意ください。
- この装置は、商工業地域で使用されるべき情報装置です。住宅地、またはその隣接した地域で使用すると、ラジオテレビジョン受信機等に、受信障害を与えることがあります。
- 補修用性能部品について
当社ではこの製品の補修用性能部品（製品の機能を維持するために必要な部品）を、製造打ち切り後8年間保有しています。この部品保有期間を修理可能の期間とさせていただきます。
- カメラシステムを使用して撮影する人物・その他の映像で、個人を特定できるものは個人情報となります。その映像の開示・公開等の取扱いは、システムを運用する方の責務となりますので、ご注意ください。

WARNING

Unauthorized recording of copyrighted slide films, materials, photographs, etc. may infringe on the rights of copyright owners and be contrary to copyright laws.

AVERTISSEMENT

La copie de film / document / photographie protégé est interdite sans autorisation expresse des détenteurs des droits de reproduction (Loi sur le Copyright). Ce Présentateur Visuel est conçu pour son emploi dans l'environnement industriel et commercial. Son emploi dans une zone résidentielle est susceptible de provoquer des interférences radioélectriques nuisibles pour le voisinage (récepteurs radio et téléviseurs).

WARNUNG

Nicht genehmigte Aufnahmen von rechtlich geschützten Diafilmen, Fotografien und ähnlichen Dokumenten können Urheberrechte verletzen und werden ggf. rechtlich verfolgt.

ADVERTENCIA

La grabación no autorizada de diapositivas, materiales, fotografías, etc. sujetos a derechos de autor puede infringir los derechos de los propietarios y las leyes de propiedad intelectual.

株式会社 エルモ社

〒 467-8567

名古屋市瑞穂区明前町 6 番 14 号

Web: <http://www.elmo.co.jp/>

OVERSEAS SUBSIDIARY COMPANIES

U.S.A. ELMO USA CORP.

Headquarters

1478 Old Country Road

Plainview, NY 11803-5034, U.S.A

Tel:(516) 501-1400 Fax:(516) 501-0429

E-mail: elmo@elmousa.com

Web: <http://www.elmousa.com>

West Coast Branch

Cypress Pointe Business Park

5676 Corporate Avenue

Cypress, CA 90630, U.S.A

Tel:(714) 828-8457 Fax:(714) 828-8429

Germany ELMO (Europe) G.m.b.H

Neanderstr. 18

40233 Düsseldorf, Germany

Tel:(0211) 386470 Fax:(0211) 376620

E-mail: info@elmoeurope.com

Web: <http://www.elmoeurope.com/>

ELMO CO., LTD.

6-14, Meizen-cho, Mizuho-ku, Nagoya,

467-8567, Japan