

VSN 990

User Manual



Contents

Introduction.....	4
Unpacking.....	5
The VSN990.....	6
Specifications.....	7
Software.....	8
ImageDP4 Video BIOS.....	8
Use of the SBC's onboard graphics adaptor	9
Hardware Installation.....	11
Connecting Expansion Chassis (VSN900X).....	13
Filter Maintenance.....	15
Datapath Limited.....	16
FCC Statement	17
Index.....	18

Safety Instructions

Safety Instructions (UK) (USA)

To prevent damage to your Datapath product or injury to personnel operating the equipment, please read the following safety precautions prior to operation. These instructions should be made available to all those who will use and operate Datapath products.

Power Supply

All Datapath products require a mains power supply. This power supply must be disconnected when equipment is being upgraded or relocated.

Cables

Do not expose cables to any liquids, doing so may cause a short circuit which could damage the equipment. Do not place heavy objects on top of any cables as this can cause damage and possibly lead to exposed live wires.

Ventilation

All computer equipment should be located in a well ventilated area. All ventilation holes on the computer casing must be kept clear of any obstruction at all times. Failure to do so will result in the system over heating and damaging your equipment.

Working Environment

The equipment should be located in an environment free from dust, moisture and extreme changes in temperature and should be placed on a stable and solid work surface. Liquids (hot/cold drinks etc) should not be placed near the equipment as spillage could cause serious damage.

Gas/Flammable Liquids

Electronic equipment should never be used in the presence of gas or any flammable liquid, doing so could result in an explosion or serious fire.

Smoke/Unusual Smells

Should you notice smoke or unusual smells being emitted from your computer, turn off and unplug the system from the mains supply. The system should then be passed to a qualified technician for inspection. Continued operation could result in personal injury and damage to property.

Maintenance

Maintenance should only be carried out by competent technicians, any Datapath plug-in cards that are physically damaged should be returned to Datapath for repair using Datapath RMA procedures.

Disposal

At the end of life all Datapath products should be disposed of as per local laws and regulations dictate. In UK contact Datapath to arrange disposal. Our WEE registration number is WEEE/A0005ZR.

Rack Mount Safety Instructions

Temperature

If VSN9go systems are to be installed in a closed or multi-unit rack assembly, the installation should be such that the amount of air flow required for safe operation of the equipment is not compromised. The operating ambient temperature of the rack environment should be maintained below 35 degrees centigrade under all conditions. Appropriate cooling arrangements should be built into the cabinet to ensure that this specification is maintained.

Mechanical Loading

Mounting of the equipment in the rack should be such that a hazardous condition is not achieved due to uneven mechanical loading.

Circuit Overloading

Consideration should be given to the connection of the equipment to the mains supply circuit and the effect that overloading of the supply might have on any overcurrent protection or supply wiring. Appropriate consideration of equipment nameplate ratings should be used when addressing this concern.

Reliable Earthing

Reliable earthing of all rack-mounted equipment should be maintained. Particular attention should be given to supply connections other than direct connections to the branch circuit (e.g. use of power strips).

Replaceable Batteries

Caution: Risk of Explosion if Battery is replaced by an Incorrect Type.

Dispose of Used Batteries According to the local laws / regulations and manufacturer's instructions.

Consignes de sécurité (Fr)

Afin de ne pas endommager votre produit Datapath et d'éviter tout risque de blessure du personnel exploitant le matériel, veuillez lire les consignes de sécurité suivantes avant toute utilisation. Ces instructions doivent être mises à disposition de toute personne souhaitant utiliser et exploiter les produits Datapath.

Alimentation électrique

Tous les produits Datapath requièrent une alimentation électrique principale. Cette alimentation électrique doit être interrompue en cas de mise à jour ou de relocalisation du matériel.

Câbles

Ne pas exposer les câbles à un liquide quelconque car cela pourrait provoquer un court-circuit susceptible d'endommager le matériel.

Ne pas placer d'objets lourds sur les câbles car cela pourrait causer des dommages et conduire éventuellement à des fils électriques dénudés.

Ventilation

Tout matériel informatique doit être disposé dans un endroit bien ventilé. Veiller à ne jamais obstruer les orifices de ventilation du boîtier de l'ordinateur ; sinon, il y a risque de surchauffe du système et votre matériel peut être endommagé.

Environnement de travail

Le matériel doit être placé sur une surface de travail stable et solide, dans un environnement exempt de poussière et d'humidité et non exposé à des variations extrêmes de températures. Ne pas placer de liquides (boissons chaudes/froides, etc.) près du matériel, car un déversement accidentel pourrait causer de graves dommages.

Gaz/Liquides inflammables

Le matériel électronique ne doit jamais être utilisé en présence de gaz ou de liquide inflammable ; cela pourrait entraîner une explosion ou un grave incendie.

Fumées/odeurs inhabituelles

Si vous constatez la présence de fumée ou d'odeurs inhabituelles émanant de votre ordinateur, éteignez-le et débranchez le système de l'alimentation secteur. Dans ce cas, le système devra être confié à un technicien qualifié pour inspection. Une poursuite de son utilisation risquerait de provoquer des blessures corporelles et des dommages matériels.

Entretien

L'entretien doit impérativement être effectué par des techniciens compétents, toute carte enfichable Datapath physiquement endommagée est à retourner à Datapath pour réparation via la procédure Datapath RMA.

Élimination

En fin de vie, tous les produits Datapath seront éliminés conformément aux législations et réglementations locales. Au Royaume-Uni, veuillez contacter Datapath pour organiser l'élimination. Notre numéro d'enregistrement de Déchets d'Équipements Électroniques et Électroniques : WEEE/A0005ZR.

Consignes de sécurité du montage sur bâti

Température

S'il est prévu d'installer les systèmes VSN9go dans une enceinte fermée ou dans un bâti comportant plusieurs unités, l'installation devra être effectuée de telle manière que le débit d'air requis pour la sûreté de fonctionnement du matériel ne soit pas compromis. La température ambiante de fonctionnement de l'environnement du bâti doit être maintenue en-dessous de 35 degrés centigrades dans toutes les conditions. Des dispositifs de refroidissement appropriés doivent être intégrés dans l'armoire de façon à garantir le maintien de cette spécification.

Charge mécanique

Le montage du matériel doit être effectué de manière à exclure toute situation dangereuse pouvant provenir d'une charge mécanique irrégulière.

Surcharge du circuit

Il convient d'apporter une certaine importance au raccordement du matériel au circuit de l'alimentation secteur et aux effets qu'une surcharge de l'alimentation pourrait avoir sur une protection contre les surintensités ou les câbles d'alimentation. Vérifiez pour cela les valeurs nominales sur les plaques d'identification du matériel.

Fiabilité de la mise à la terre

Veiller à une mise à la terre fiable de tout matériel monté sur bâti. Une attention particulière devra être accordée aux raccordements d'alimentation autres que les raccordements directs au circuit de dérivation (utilisation de multiprises par exemple).

Batteries remplaçables

Attention : Risque d'explosion si la batterie est remplacée par un type incorrect.

Jetez les piles usagées conformément aux lois / réglementations locales et aux instructions du fabricant.

Instrucciones de seguridad (Esp)

Rogamos leer las siguientes instrucciones de seguridad antes de poner en funcionamiento el equipo, a fin de evitar daños en su producto de Datapath o lesiones al personal encargado de su manejo. Poner estas instrucciones a disposición de todos aquellos que vayan a utilizar y/o manejar los productos de Datapath.

Alimentación eléctrica

Todos los productos de Datapath requieren una fuente de alimentación eléctrica. Esta fuente de alimentación eléctrica debe ser desconectada durante las tareas de renovación o traslado.

Cables

No exponer los cables a líquidos, ya que ello puede causar un cortocircuito y, por consiguiente, daños en el equipo. No colocar objetos pesados sobre los cables, ya que esto puede ocasionar daños y poner al descubierto los cables vivos.

Ventilación

Todos los equipos informáticos deben estar situados en un área bien ventilada. Mantener todos los orificios de ventilación de la carcasa de Datapath o lesiones al personal encargado de su manejo. En caso contrario, podría producirse un sobrecalentamiento del sistema y daños en el equipo.

Entorno de trabajo

El equipo debe estar emplazado en un ambiente sin polvo, humedad ni cambios bruscos de temperatura y debe ser situado sobre una superficie estable y sólida. No colocar líquidos (bebidas calientes/frías, etc.) cerca del equipo, ya que un derrame podría causar graves daños.

Gas/líquidos inflamables

El equipo electrónico nunca debe ser usado en presencia de gas o líquido inflamable, ya que esto podría causar una explosión o un incendio grave.

Humo/olores inusuales

En caso de percibir humo u olores inusuales provenientes de su ordenador, apagar y desenchufar el equipo de la red eléctrica. El sistema debe ser confiado entonces a un técnico cualificado para su inspección. Si el equipo continuara funcionando, esto podría ocasionar lesiones personales y daños materiales.

Mantenimiento

El mantenimiento solo debe ser ejecutado por técnicos capacitados. Las tarjetas insertables (plug-in) de Datapath que estén físicamente dañadas deben ser devueltas a Datapath para su reparación según los procedimientos RMA (Return Merchandise Agreement) de Datapath.

Eliminación

Al final de su vida útil, todos los productos de Datapath deben ser eliminados de acuerdo con las leyes y normativas locales. En el Reino Unido, contactar a Datapath para organizar la eliminación. Nuestro número de registro WEE (Waste Electrical and Electronic Equipment) es WEEE/A0005ZR.

Instrucciones de seguridad para montaje en bastidor

Temperatura

Si los sistemas VSN9go se montan en un bastidor cerrado o en un bastidor de varias unidades, la instalación se deberá realizar evitando que afecte al flujo de aire necesario para un funcionamiento seguro. Mantener la temperatura ambiente del entorno del bastidor por debajo de los 35 grados centígrados bajo todo tipo de condiciones. Instalar en el armario los dispositivos adecuados de refrigeración a fin de asegurar que se cumple esta especificación.

Carga mecánica

Efectuar el montaje del equipo en el bastidor de tal modo que se eviten situaciones de peligro debidas a una carga mecánica irregular.

Sobrecarga del circuito

Tener especial cuidado al realizar la conexión del equipo al circuito de la red eléctrica a fin de evitar que una sobrecarga de ésta pueda afectar a algún dispositivo de protección contra corriente de sobretensión o al cableado de alimentación. Tener en cuenta las capacidades especificadas en la placa indicadora del equipo al conectarlo a la red.

Puesta a tierra segura

Asegurar la puesta a tierra segura de todos los equipos montados en bastidor. Prestar especial atención a las conexiones de alimentación que no sean conexiones directas al circuito en derivación (por ejemplo, mediante regletas).

Baterías reemplazables

Precaución: Riesgo de explosión si la batería se sustituye por otra de tipo incorrecto.

Deseché las baterías usadas según las leyes / regulaciones locales y las instrucciones del fabricante.

Sicherheitsanweisungen (D)

Die folgenden Sicherheitsanweisungen dienen der Vermeidung von Schäden an Ihrem Datapath-Produkt und Verletzungen der Nutzer. Bitte lesen Sie sie sorgfältig durch, bevor Sie Ihr Produkt in Betrieb nehmen. Diese Anweisungen sollten allen Personen zugänglich gemacht werden, die mit der Nutzung und der Bedienung von Datapath-Produkten betraut sind.

Stromversorgung

Alle Datapath-Produkte müssen an die Hauptstromversorgung angeschlossen werden. Die Stromversorgung muss unterbrochen werden, wenn Geräte ausgetauscht oder an einer anderen Stelle platziert werden sollen.

Kabel

Kabel dürfen nicht mit Flüssigkeiten in Berührung kommen, da dadurch ein Kurzschluss und somit ein Schaden an dem Gerät ausgelöst werden könnte. Stellen Sie außerdem keine schweren Objekte auf die Kabel, um Schäden und offen liegende stromführende Leitungen zu vermeiden.

Lüftung

Computerausüstung sollte in einem gut gelüfteten Bereich aufgestellt werden. Die Lüftungslöcher am Computergehäuse müssen stets freigehalten werden, um eine Überhitzung und somit einen Geräteschaden zu vermeiden.

Arbeitsumgebung

Die Geräte sollten in einer staubfreien und trockenen Umgebung, in der keine extremen Temperaturänderungen zu erwarten sind, auf einer stabilen Arbeitsfläche aufgestellt werden. In der Nähe der Geräte sollten keine Flüssigkeiten (heiße/kalte Getränke etc.) platziert werden, die verschüttet werden und schwerwiegende Schäden anrichten könnten.

Gas/brennbare Flüssigkeiten

Elektronische Geräte sind nicht in Umgebungen zu verwenden, in denen Gas oder brennbare Flüssigkeiten vorhanden ist/sind und somit Brand- und Explosionsgefahr besteht.

Rauch/ungewöhnliche Gerüche

Schalten Sie das System aus und trennen Sie es von der Hauptversorgung, wenn von Ihrem Computer Rauch ausgeht oder dieser ungewöhnliche Gerüche abgibt. Lassen Sie das System anschließend von einem qualifizierten Techniker prüfen. Bei fortgeführtem Betrieb besteht die Gefahr von Verletzungen und Sachschäden.

Wartung

Wartungsarbeiten sollten nur von qualifizierten Technikern durchgeführt werden. Physisch beschädigte Plug-in-Karten von Datapath sollten zur Reparatur unter Einsatz der RMA-Verfahren von Datapath an Datapath übergeben werden.

Entsorgung

Am Ende ihrer Nutzungsdauer sollten Datapath-Produkte gemäß den lokalen Gesetzen und Bestimmungen entsorgt werden. Für Nutzer in Großbritannien: Bitte kontaktieren Sie Datapath, um Vorkehrungen zur Entsorgung von Datapath-Produkten zu treffen. Unsere WEE-Registrierungsnummer lautet WEEE/A0005ZR.

Sicherheitsanweisungen zur Rack-Montage

Temperatur

Um einen sicheren Betrieb zu gewährleisten, muss ausreichend Luft zur Kühlung sichergestellt werden, wenn VSN9go-Systeme in einem geschlossenen Rack-Aufbau oder einem Aufbau für mehrere Geräte installiert werden. Die Umgebungstemperatur in dem Bereich, in dem sich das Rack befindet, sollte stets unterhalb von 35°C liegen. Das Gehäuse sollte mit einer Vorrichtung zur angemessenen Kühlung ausgestattet sein, sodass diese Spezifikation erfüllt werden kann.

Mechanische Belastung

Um Gefahrensituationen zu vermeiden, muss bei der Platzierung der Geräte in das Rack auf eine gleichmäßige mechanische Belastung geachtet werden.

Schaltkreisüberlastung

Beim Anschluss der Geräte an die Hauptstromversorgung sollten die Auswirkungen berücksichtigt werden, die eine Überlastung der Stromversorgung auf einen eventuell vorhandenen Überstromschutz oder Versorgungsleitungen haben könnte. In diesem Zusammenhang sind die Typenschilder der Geräte zu beachten.

Zuverlässige Erdung

In Bezug auf in Racks montierte Geräte ist stets auf eine zuverlässige Erdung und insbesondere auf Versorgungsleitungen zu achten, die nicht direkt an den jeweiligen Stromkreis angeschlossen sind (Nutzung von Steckerleisten etc.).

auswechselbare Batterien

Achtung: Explosionsgefahr, wenn Batterie durch einen falschen Typ ersetzt wird.

Entsorgen Sie gebrauchte Batterien entsprechend der örtlichen Gesetze / Vorschriften und Anweisungen des Herstellers.

Introduction

The VSN9go wall controller is a highly expandable and flexible solution for video wall and multi-screen display applications. The controller is optimised for operation with the latest generation of Datapath PCI express graphics and video capture cards. The VSN9go can also be used with the VSN9goX expansion chassis.

The VSN9goX is a general purpose 9-slot PCIe expansion chassis that can be used with any host PC to expand the number of available PCIe slots. (Note: The host PC must have one x 8 lane slot available)

Unpacking

Your packing box should contain the following items:

- The VSN990 Chassis (Large systems may also include the VSN900X expansion chassis)
- Express9-G3 backplane (installed)
- SBC3 (installed) (VSN990 only)
- Mouse (VSN990 only)
- Keyboard (VSN990 only)
- Cables and Adapters (See Quantity guide Fig. 1)
- Software Installation Suite CD (VSN990 only.) This CD contains all of the software required for the VSN990, including the drivers for the capture cards and the Wall Control application software.
- SBC documentation (VSN990 only)

If there are any discrepancies, you should contact Datapath immediately.

Cables and Adapters - Quantity Guide

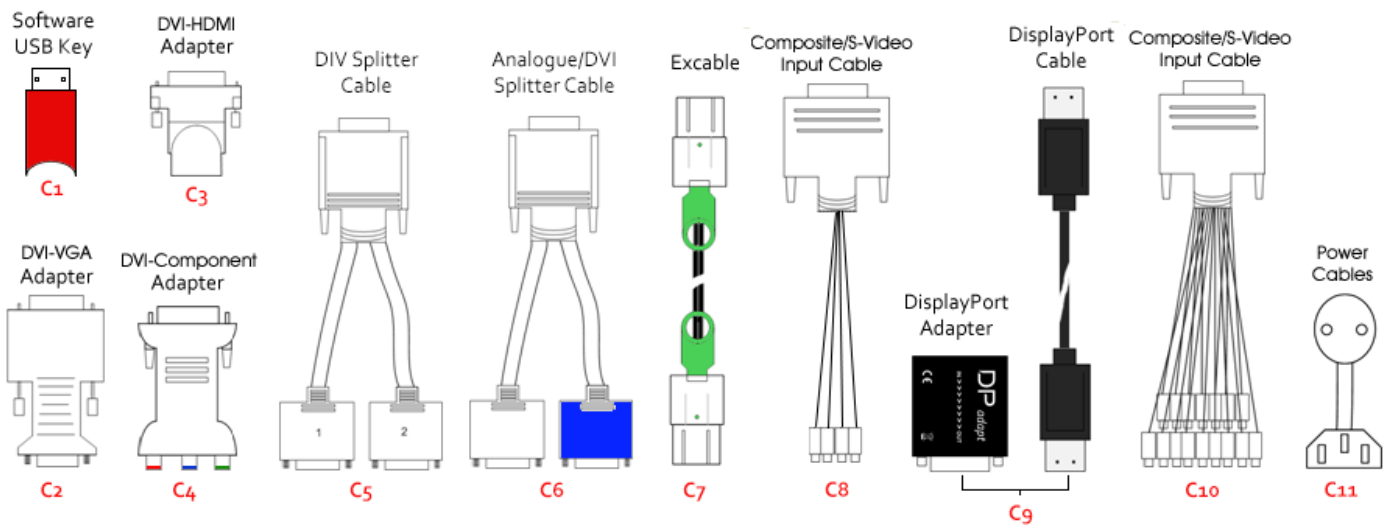

Fig.1

C1	x 1 - optional. If requested this item may be installed inside the VSN990
C2	x2 per VisionRGB-E2S card. x1 per VisionRGB-E1S and VisionSD4+1 card
C3	x1 per VisionRGB-E1S/E2S card. x1 per VisionSD4+1 card
C4	x1 per VisionRGB-E1S/E2S card. x1 per VisionSD4+1 card
C5	x2 per VisionHD4
C6	x1 per SBC3
C7	x1 per Expansion Chassis
C8	x1 per VisionSD4+1 card
C9	x4 per ImageDP4 graphics card (Optional powered/non-powered cables)
C10	x1 per VisionSD8
C11	x2 for the RPSU

The VSN990

Features – VSN990

- Quad Core Industrial PC with 9 PCIe slots
- SBC₃ - Quad Core™ Xeon® processor based PICMG1.3 SBC
- 1 to 64 Display channels using the ImageDP₄ graphics card
- 4 to 128 video capture channels using the VisionSD₈ or VisionSD₄₊₁ capture cards
- 1 to 32 RGB/HD/DVI capture channels using the VisionRGB-E₁/E₂S capture cards
- Expand with 1 or 2 VSN900X expansion chassis providing a maximum of 25 PCI express slots
- Compatible with Datapath Wall Control-red

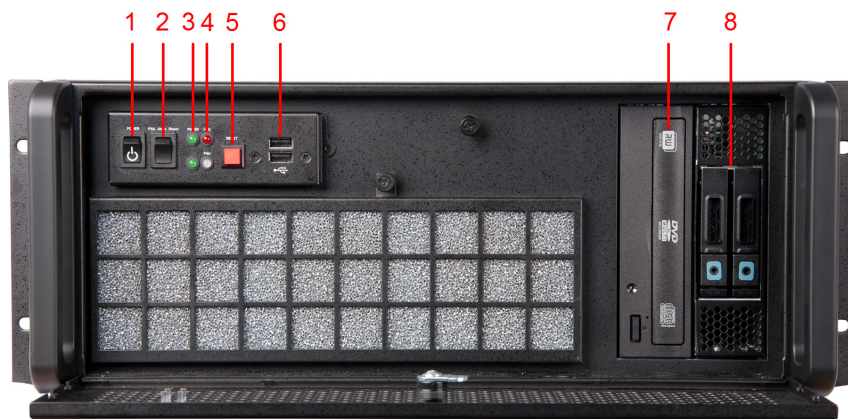

Fig.2

1 = Power	5 = Reset Button
2 = PSU Alarm Reset	6 = USB Ports
3 = Power LED	7 = DVD +RW
4 = HDD LED	8 = Removable Hard Drives

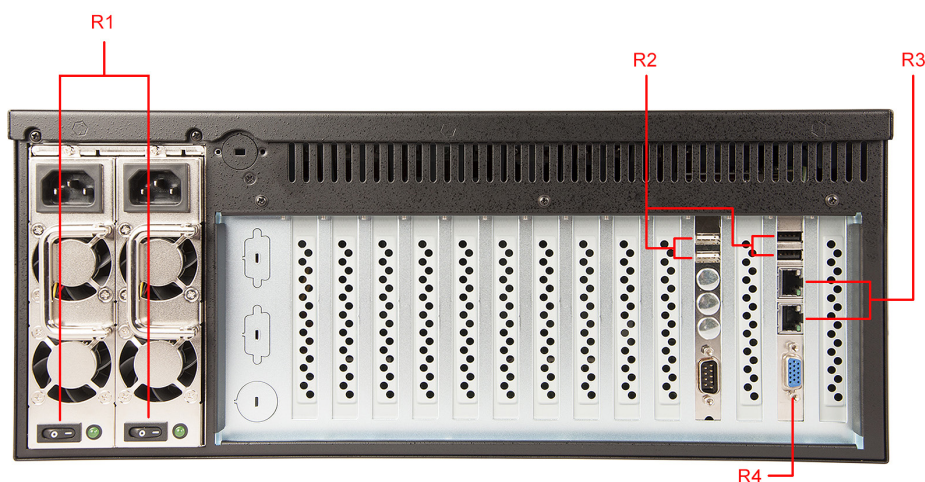

Fig.3

R1 = Power Switches (RPSU)	R3 = Ethernet Ports
R2 = USB Ports	R4 = VGA Output

Specifications

19" 4U Industrial PC chassis
Dimensions (approx) Length 500mm (incl handles, Height 177mm, Width 481mm (incl mounting brackets)
SBC3- Intel® Dual Quad Core Xeon EC5549 chipset in LGA 1366 Package (VSN990 only)
16GB DDR3 1333 EEC registered system memory (VSN990 only)
Express9 PCIe back plane providing 1 x8 lane slot and 8 x4 lane slots
Two 750GB removable SATA hard drives - Enterprise Grade (VSN990 only)
One DVD/RW combo drive (VSN990 only)
Two Gigabit Ethernet ports (VSN990 only)
VGA output enabling connection to VGA using the cable provided. (Can be used as a control screen) (VSN990 only)
800 Watt Redundant PSU
Noise - 48.6dB(A) up to 67.9 db(A); Dependent on system configuration and ambient temperature
Triple cooling fans with removable air filter
Includes keyboard and mouse (VSN990 only)
Windows 7 64bit operating system (VSN990 only)
Operating temperature: 0 to 35 Deg C
3 year warranty

Models

Code	Description
VSN990-RSPU	Controller chassis with 800 Watt RPSU
VSN900X-RSPU	Expansion chassis with 600 Watt RPSU
VSN900X-ATX	Expansion chassis with 600 Watt ATX

Software

Each VSNg90 shipped by Datapath is custom built. If cards are not pre-installed then installation of the software is required. For information on software installation consult the relevant user manual contained on the installation CD.

If you have ordered Datapath Wall Control-red software this will have been installed prior to shipment.

ImageDP4 Video BIOS

The Intel x86 based architecture limits the amount of legacy I/O space available in a system to 64KB. Hardware which requires I/O access can be mapped into this 64KB area. An ImageDP4 requests 256 Bytes of legacy I/O. Unfortunately any PCIe bridge will align this to a 4KB boundary and so the I/O space allocated to each ImageDP4 is actually 4KB.

$64\text{KB} \div 4\text{KB}$ gives an absolute maximum of 16 ImageDP4 graphics cards. However, other system devices also require legacy I/O. Often the Network Devices will request some I/O space, and so might the USB devices and on-board graphics. It is not unusual for there to be I/O space available for only 8 ImageDP4 graphics cards when installing them in a complex server class motherboard.

There are a number of different BIOS types in operation as the computer boots. The "System BIOS" is resident on the motherboard and is responsible for starting up all the hardware and mapping in the resources (like the I/O) so that they are available to the CPU. The "Video BIOS" is resident on the graphics cards. It is responsible for booting the GPU and for informing the System BIOS which resources will be required for the GPU to operate correctly.

The System BIOS requires an I/O enabled ImageDP4 if it is used as the boot device, i.e. it provides the graphics output that displays the BIOS boot messages. However the Windows driver for the ImageDP4 has been designed so that it does not require I/O. We can therefore use two types of Video BIOS for the ImageDP4, one which requests I/O (and which can be used as a boot device) and one which does not. This allows us to increase the number of ImageDP4 cards which can be used in a system.

To find out more about how to choose the correct BIOS for your requirements and how to update the BIOS for the ImageDP4, download a PDF from our website by clicking on the link below or select it from the Read Me file on the Software Installation Suite CD supplied with your ImageDP4 card:

www.datapath.co.uk

Use of the SBC's onboard graphics adaptor

Onboard Graphics Adaptor used as Control Screen

The VSN990 is shipped with the BIOS configured to boot off the onboard graphics device. This output can then be used as the control screen for a typical wall configuration.

To set the system to boot on the onboard graphics device enter setup from the boot screen by pressing <F2> as prompted.

In the BIOS setup utility select:

Boot>Primary Display>Onboard VGA

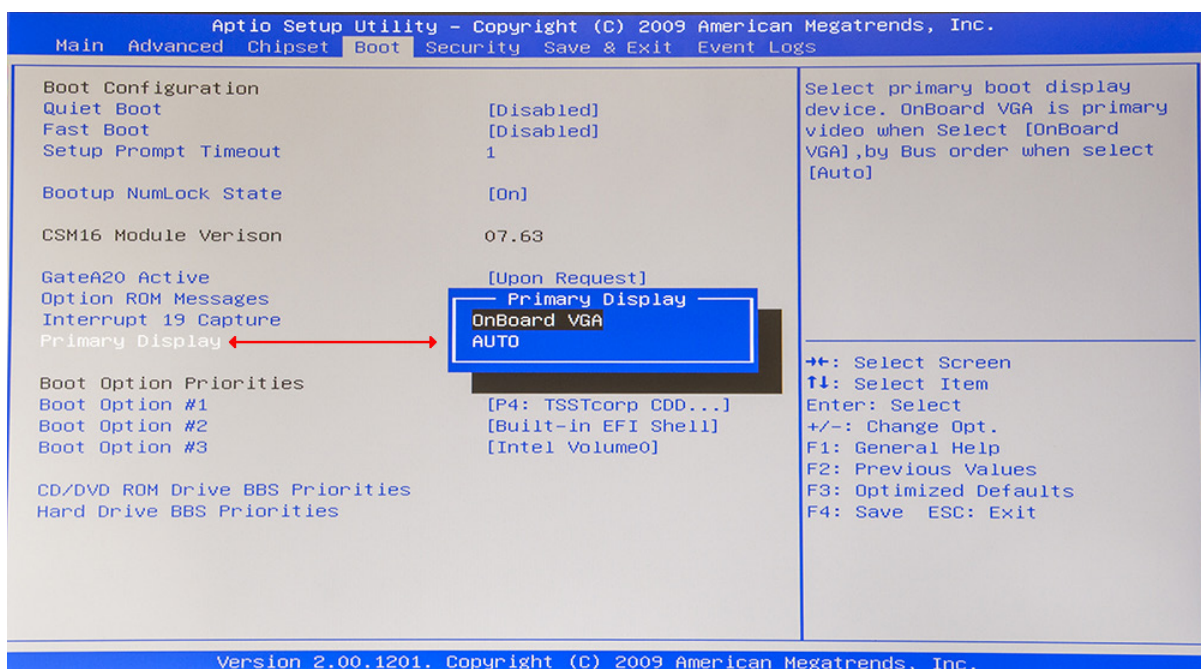

Fig.5

Onboard Graphics Adaptor Disabled

If you do not require a control screen, then you should disable the integrated graphics as described below.

Connect a monitor to the onboard graphics device output and enter setup from the boot screen by pressing <F2> as prompted.

In the BIOS setup utility select:

Boot>Primary Display>Onboard VGA

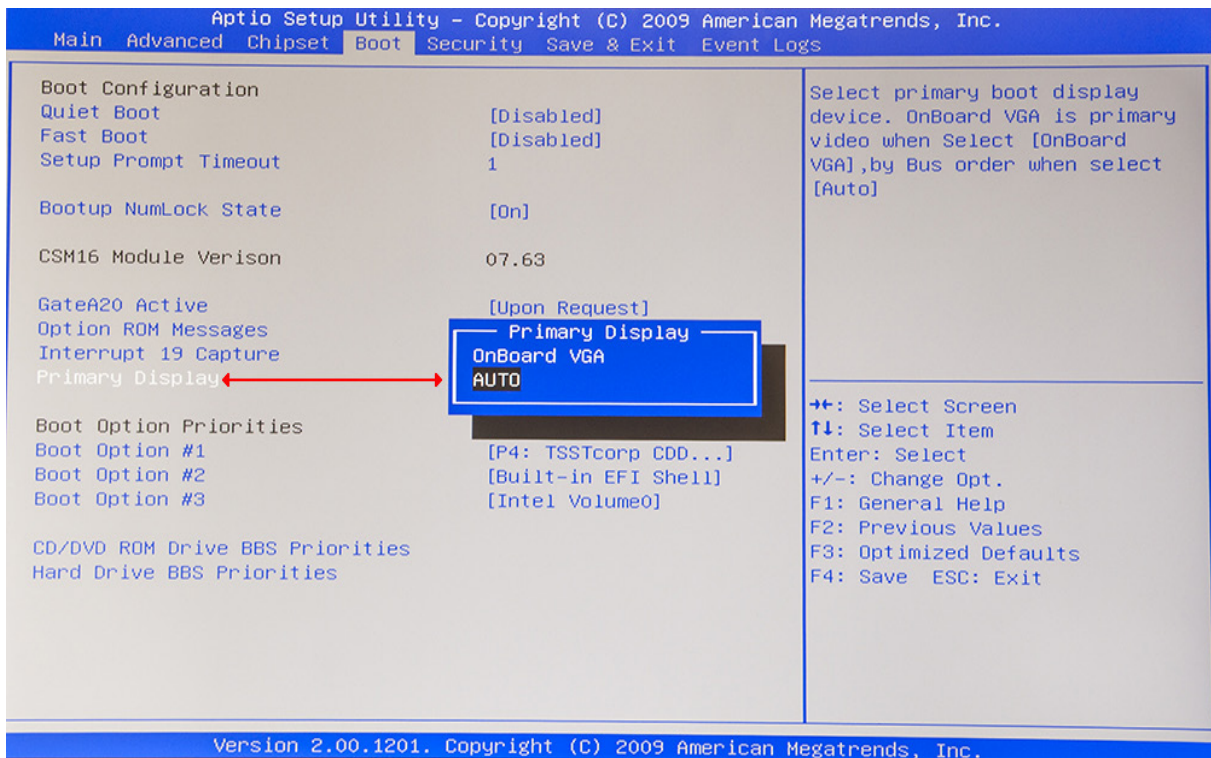

Fig.6

The system will then boot on an output from the graphics card identified first by the PCI Bus.

Hardware Installation

Your VSN990 may have cards that require installation as cards may have been shipped separately.

To ensure your cards are installed correctly please consult the user manual for detailed instructions. All user manuals can be located on the Software Installation Suite CD.

VSN990 Backplane Layout

The VSN990 is fitted with the Datapath Express9-G3 backplane. The backplane consists of:

- One PICMG1.3 slot
- One x8 lane PCIe slot
- Eight x4 lane PCIe slots

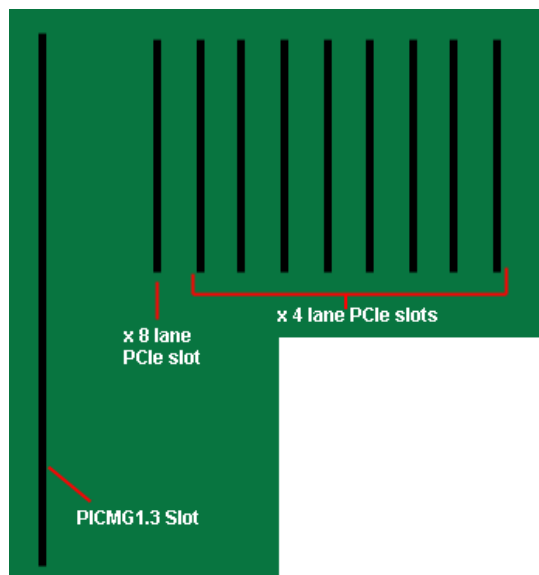

Fig.7

PCIe Port Width

PICMG	X8
SLOT 1	X8
SLOT 2	X4
SLOT 3	X4
SLOT 4	X4
SLOT 5	X4
SLOT 6	X4
SLOT 7	X4
SLOT8	X4
SLOT9	X4

Express9-G3 Connectors

FAN1, FAN2, FAN3	4 pin fan speed control header Pin 1 : GND Pin 2 : +12V Pin 3 : TACH Pin 4 : PWM	J11, J12	SATA 2.0 Pin 1 : 0V Pin 2 : A+ Pin 3 : A- Pin 4 : 0V Pin 5 : B- Pin 6 : B+ Pin 7 : 0V
FAN5, FAN6, FAN7, FAN8	3 pin fan header (non speed control) Pin 1 : GND Pin 2 : +12V Pin 3 : N/C	J13	Debug I2C Pin 1 : SCL Pin 2 : 0V Pin 3 : SDA Pin 4 : N/C Pin 5 : N/C Pin 6 : N/C Pin 7 : N/C Pin 8 : N/C Pin 9 : N/C Pin10 : 0V
FAN9	2 pin fan header (non speed control) Pin 1 : GND Pin 2 : +12V	J14, J15	USB 2.0 Pin 1 : +5V Pin 2 : +5V Pin 3 : USB1N Pin 4 : USB0N Pin 5 : USB1P Pin 6 : USB0P Pin 7 : 0V Pin 8 : 0V Pin 9 : N/C Pin10 : N/C
J1,J2	ATX Power Connector Pin 1 : +3.3V Pin13 : +3.3V Pin 2 : +3.3V Pin14 : -12V Pin 3 : 0V Pin15 : 0V Pin 4 : +5V Pin16 : PS_ON# Pin 5 : 0V Pin17 : 0V Pin 6 : +5V Pin18 : 0V Pin 7 : 0V Pin19 : 0V Pin 8 : PWR_ON Pin20 : N/C Pin 9 : +12V Pin21 : +5V Pin10 : +12V Pin22 : +5V Pin11 : +12V Pin23 : +5V Pin12 : +3.3V Pin24 : 0V	J16	Panel LED Pin 1 : LED Anode Pin 2 : LED Cathode
J7	Panel Power Pushbutton Connector Pin 1 : PWRBUT Pin 2 : 0V	J17	PLX EEPROM Select Pin 1-2 : EEPROM U4 Pin 2-3 : EEPROM U14
J8	Panel Reset Pushbutton Connector Pin 1 : SHB_RST Pin 2 : 0V	J18	AUX Power Connector Pin 1 : 0V Pin 5 : +12V Pin 2 : 0V Pin 6 : +12V Pin 3 : 0V Pin 7 : +12V Pin 4 : 0V Pin 8 : +12V
J6	AUX Power Connector Pin 1 : 0V Pin 5 : +12V Pin 2 : 0V Pin 6 : +12V Pin 3 : 0V Pin 7 : +12V Pin 4 : 0V Pin 8 : +12V	J19	PLX I2C Pin 1 : SCL Pin 2 : 0V Pin 3 : SDA Pin 4 : N/C Pin 5 : N/C Pin 6 : N/C Pin 7 : N/C Pin 8 : N/C Pin 9 : N/C Pin10 : 0V
J10	JTAG Pin 1 : TCK Pin 2 : 0V Pin 3 : TDO Pin 4 : +3V Pin 5 : TMS Pin 6 : +3V Pin 7 : N/C Pin 8 : TRST Pin 9 : TDI Pin10 : 0V	J20	PLX Debug Speed Select Pin 1-2 : All slots Gen 1 Pin 2-3 : All slots Gen 3

Connecting Expansion Chassis (VSN900X)

It is possible to connect a VSN900X expansion chassis to the VSN990 thereby increasing the number of PCIe slots available.

The following diagrams illustrate how this can be achieved:

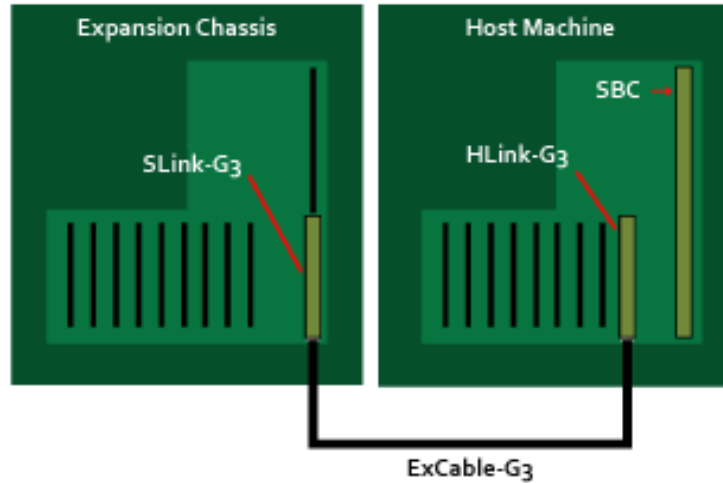

Fig.8

Connecting the chassis is achieved by installing HLink-G3 and SLink-G3 cards in the VSN990 and VSN900X and connecting the two cards using the Ex-Cable-G3.

The HLink-G3 and Slink-G3 cards are factory installed into a system as a pair. When connecting expansion chassis ensure that the pair labelled Link1 are connected using the ExCable-G3, the pair labelled Link2 are connected together and so on. In the event that this is not possible, connect the expansion chassis to the host machine and re-install the Datapath Driver Install to reset the pairings.

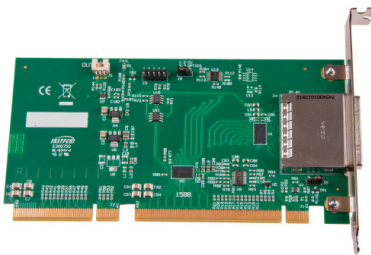

Fig.9 SLink-G3



Fig.10 ExCable-G3

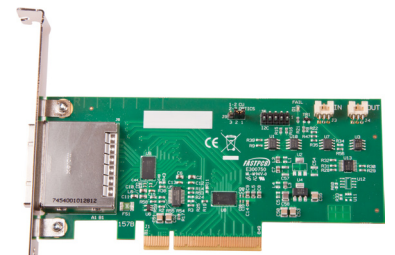

Fig.11 HLink-G3

When connecting a VSN900X expansion chassis to a VSN990 machine the HLink-G3 card in the VSN990 must be installed into the x8 slot. The SLink-G3 card in the VSN900X should be installed in the PICMG1.3 SBC slot.

VSN990 LED's

The VSN990 and VSN990X have an LED for each PCIe slot and the PICMG1.3 SBC slot.

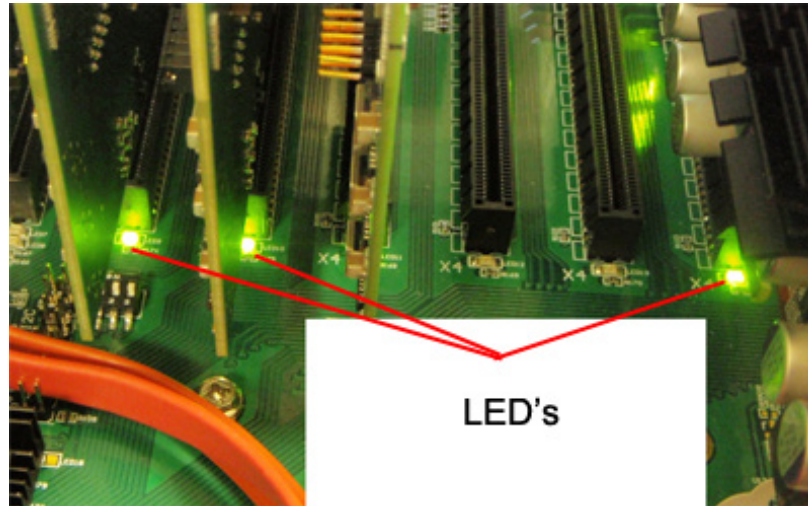

Fig.12

The LED's indicate the following:

LED1	ON = +5V Standby Voltage present
LED2	ON = +5V supply present
LED3	ON = +12V supply present
LED4	ON = +3.3V supply present
LED5	ON = PICMG link speed = Gen3, FLASH-FAST = Gen2, FLASH-SLOW = Gen1
LED7	ON = PCIe Slot 1 link speed = Gen3, FLASH-FAST = Gen2, FLASH-SLOW = Gen1
LED9	ON = PCIe Slot 2 link speed = Gen3, FLASH-FAST = Gen2, FLASH-SLOW = Gen1
LED10	ON = PCIe Slot 3 link speed = Gen3, FLASH-FAST = Gen2, FLASH-SLOW = Gen1
LED11	ON = PCIe Slot 4 link speed = Gen3, FLASH-FAST = Gen2, FLASH-SLOW = Gen1
LED12	ON = PCIe Slot 5 link speed = Gen3, FLASH-FAST = Gen2, FLASH-SLOW = Gen1
LED13	ON = PCIe Slot 6 link speed = Gen3, FLASH-FAST = Gen2, FLASH-SLOW = Gen1
LED14	ON = PCIe Slot 7 link speed = Gen3, FLASH-FAST = Gen2, FLASH-SLOW = Gen1
LED15	ON = PCIe Slot 8 link speed = Gen3, FLASH-FAST = Gen2, FLASH-SLOW = Gen1
LED16	Not Used

No LED's flashing indicates that lane width has not been established. The LED's will not flash on slots where no cards are installed.

Filter Maintenance

The system filter is an integral part of the wall controller and as such it needs to be maintained correctly. Failure to maintain the filter can result in the system overheating and causing it to fail. In normal operating conditions the filter should be removed and cleaned every 3 months. However, this 3 month period is a guide only and it can be increased to every 6 months or decreased to one month depending on the levels of dust in the environment the system is operating in.

It is recommended that the condition of the filter is checked at regular intervals.

The filter can be removed and cleaned whilst the system is in operation, system shutdown is not necessary.

Note:

Failure to maintain the system filter could result in damage to your system and invalidate the warranty.

Remove the Filter

Open the front panel door and locate the filter housing screw, remove the screw and lift the filter housing away from the front panel.



Remove the filter from the housing and shake it to remove any dust particles, this should not be done in close proximity to the system to avoid dust ingress. Ideally, the filter should be cleaned using a vacuum cleaner.

Note: The filter should never be immersed in water or any other cleaning liquid.

For advice on replacement filters, please contact Datapath Ltd.

Datapath Limited

Datapath has a long and very successful history in the computer graphics industry. Datapath has been designing and supplying high performance, high quality graphics display systems to the world's largest and most demanding companies and institutions since 1982. Datapath was one of the founding companies of multi-screen Windows acceleration using single and multi board solutions. Now using the very latest display technology Datapath offers some of the world's leading multi screen graphics accelerators for the most demanding applications.

As new technology advances, so we at Datapath improve the performance and functionality of both our hardware and software to give our customers more. Following a continuous development program, we pride ourselves on our support and responsive nature towards all our customers and their changing needs. As more sophisticated equipment and techniques become readily available, so we are there to exploit the power and potential that this technology presents.

Technical Support

Registered Users can access our technical support line using, email, and the Support page on the Datapath Web Site, usually with a response within 24 hours (excluding weekends).

Via Email

Send an email to support@datapath.co.uk with as much information about your system as possible. To enable a swift response we need to know the following details:

Specification of the PC - including processor speed

Operating System

Application Software

Datapath Hardware / Software

The exact nature of the problem - and please be as specific as possible.

Please quote version and revision numbers of hardware and software in use wherever possible.

Copyright Statement

© Datapath Ltd., England, 2014

Datapath Limited claims copyright on this documentation. No part of this documentation may be reproduced, released, disclosed, stored in any electronic format, or used in whole or in part for any purpose other than stated herein without the express permission of Datapath Limited.

Whilst every effort is made to ensure that the information contained in this on-line help is correct, Datapath Limited make no representations or warranties with respect to the contents thereof, and do not accept liability for any errors or omissions. Datapath reserves the right to change specification without prior notice and cannot assume responsibility for the use made of the information supplied. Datapath Limited acknowledges all registered trademarks used within this documentation.

FCC Statement

This equipment has been tested and found to comply with the limits for a Class A digital device, pursuant to part 15 of the FCC Rules. These limits are designed to provide reasonable protection against harmful interference when the equipment is operated in a commercial environment. This equipment generates, uses, and can radiate radio frequency energy and, if not installed and used in accordance with the instruction manual, may cause harmful interference to radio communications. Operation of this equipment in a residential area is likely to cause harmful interference in which case the user will be required to correct the interference at their own expense.

Changes or modifications not expressly approved by the party responsible for compliance, could void the user's authority to operate the equipment.

UK Headquarters and Main Sales Office

Datapath Ltd.,
Bemrose House, Bemrose Park, Wayzgoose Drive
Derby, DE21 6XQ, UK
Tel: +44 (0) 1332 294441
Fax: +44 (0) 1332 290667

Email: sales@datapath.co.uk
www.datapath.co.uk

Index

B

Backplane Layout 11
BIOS setup 9

C

Cable 3
Capture channels 6
Copyright 15

D

Dimensions 7

E

Email 15
Expansion chassis 13

F

FCC Statement 16
Features 6
Filter Maintenance 15

I

Introduction 4

L

LED's 14

M

Maintenance 3
Models 7
Multi-unit rack assembly 3

O

Onboard Graphics 9
Operating system 7

P

Packing box 5
Power supply 3

R

RPSU 7

T

Technical support 15
Transit packaging 5

W

Wall Control 6, 8
Warranty 7