

VSN 970

User Manual



Contents

Introduction.....	4
Unpacking.....	5
The VSN970.....	6
Specifications.....	7
Software.....	8
ImageDP4 Video BIOS.....	8
Use of the SBC's onboard graphics adaptor.....	9
Hardware Installation.....	11
Connecting Expansion Chassis (VSN900X).....	13
Filter Maintenance.....	15
Datapath Limited.....	16
FCC Statement.....	17
Index.....	18

Introduction

The VSN970 wall controller is a highly expandable and flexible solution for video wall and multi-screen display applications. The controller is optimised for operation with the latest generation of Datapath PCI express graphics and video capture cards. The VSN970 can also be used with the VSN range of expansion chassis.

The VSN900X is a general purpose 9-slot PCIe expansion chassis that can be used with any host PC to expand the number of available PCIe slots. (Note: The host PC must have one x 8 lane slot available)

Unpacking

Your packing box should contain the following items:

- The VSN970 Chassis (Large systems may also include the VSN900X expansion chassis)
- Express9-G3 backplane (installed)
- SBC4 (installed) (VSN970 only)
- Mouse (VSN970 only)
- Keyboard (VSN970 only)
- Cables and Adapters (See Quantity guide Fig. 1)
- Software Installation Suite CD (VSN970 only.) This CD contains all of the software required for the VSN970, including the drivers for the capture cards and the Wall Control application software.
- SBC documentation (VSN970 only)

If there are any discrepancies, you should contact Datapath immediately.

Approved Cables and Adapters - Quantity Guide

If your system is populated with Datapath PCI Express plugin cards the following cables and adapters are supplied as per the quantity guide below.

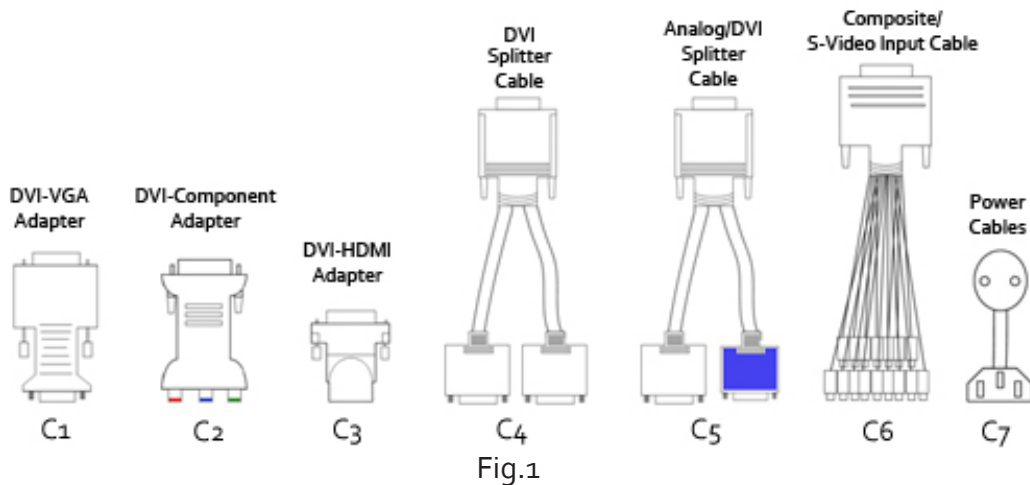

C1	x2 per VisionRGB-E2S card. x1 per VisionRGB-E1S and VisionSD4+1 card
C2	x1 per VisionRGB-E1S/E2S card. x1 per VisionSD4+1 card
C3	x1 per VisionRGB-E1S/E2S card. x1 per VisionSD4+1 card
C4	x2 per VisionHD4 card
C5	x 1 per SBC4
C6	x1 per VisionSD8 and x1 per VisionSD4+1 card
C7	x2 for the RPSU

The VSN970

Features – VSN970

The VSN970 system incorporates the Datapath PCI Express9-G3 switched fabric backplane, providing 9 high bandwidth PCIe slots for use with any Datapath video capture or graphics card. Also providing further benefits with the Datapath's SBC4, a single board computer featuring an Intel Core i7 processor with up to 16GB of DDR3 memory and on-board graphics.

The backplane provides a single x8 lane slot (8GB/s) and eight x4 lane slots (4GB/s) each providing high speed bi-directional bandwidth. Allows UHD video to be captured and then displayed on the video wall with very low latency.

Each system comes complete with high quality, server grade hard drives with RAID 1, preinstalled with Windows 7® Ultimate edition (64bit). Enhanced system cooling is achieved via 3 variable speed fans, and each system offers on-board SATA and USB ports.

The use of PCIe switched fabrics, enables the VSN970 system to be expanded using additional backplanes within VSN900X chassis connected via the optional expansion kit.



Fig.2

1 = Power	5 = Reset Button
2 = PSU Alarm Reset	6 = USB Ports
3 = Power LED	7 = DVD +RW
4 = HDD LED	8 = Removable Hard Drives



Fig.3

R1 = Power Switches (RPSU)	R3 = Ethernet Ports
R2 = USB Ports	R4 = DVI-I Output

Specifications

19" 4U Industrial PC chassis
Dimensions (approx) Length 500mm (incl handles, Height 177mm, Width 481mm (incl mounting brackets)
SBC4 - Core i7 4770S CPU 3.1GHz PICMG1.3 SBC with DVI/VGA, High speed dual Gigabit LAN, SATA RAID USB2.0/3.0 and Audio and 16-bit GPIO (VSN970 only)
8GB DDR2 1600 DDR3 non-EEC registered system memory with an upgrade option of 16GB (VSN970 only)
Express9-G3 PCIe back plane providing 1 x8 lane slot and 8 x4 lane slots
Two 750GB removable SATA hard drives - Enterprise Grade (VSN970 only)
One DVD/RW combo drive (VSN970 only)
Two Gigabit Ethernet ports (VSN970 only)
DVI-I output enabling connection to DVI/VGA using the cable provided. (Can be used as a control screen) (VSN970 only)
500 Watt ATX Power supply, or 600 Watt Dual Redundant RPSU
Noise - 48.6dB(A) up to 67.9 db(A); Dependent on system configuration and ambient temperature
Triple cooling fans with removable air filter
Includes keyboard and mouse (VSN970 only)
Windows 7 64bit operating system (VSN970 only)
Operating temperature: 0 to 35 Deg C
Weight - 19 to 25Kgs Shipping Weight - 30 to 35 Kgs
3 year warranty.

Models

VSN970-RPSU	Controller chassis with 600 Watt RPSU
VSN970-ATX	Controller chassis with 500 Watt ATX
VSN900X-RPSU	PCIe expansion chassis with 600 Watt RPSU
VSN900X-ATX	PCIe expansion chassis with 500 Watt ATX

Software

Each VSN970 shipped by Datapath is custom built. If cards are not pre-installed then installation of the software is required. For information on software installation consult the relevant product user manual contained on the installation CD.

If you have ordered Datapath Wall Control-red software this will have been installed prior to shipment.

ImageDP4 Video BIOS

The Intel x86 based architecture limits the amount of legacy I/O space available in a system to 64KB. Hardware which requires I/O access can be mapped into this 64KB area. An ImageDP4 requests 256 Bytes of legacy I/O. Unfortunately any PCIe bridge will align this to a 4KB boundary and so the I/O space allocated to each ImageDP4 is actually 4KB.

$64\text{KB} \div 4\text{KB}$ gives an absolute maximum of 16 ImageDP4 graphics cards. However, other system devices also require legacy I/O. Often the Network Devices will request some I/O space, and so might the USB devices and on-board graphics. It is not unusual for there to be I/O space available for only 8 ImageDP4 graphics cards when installing them in a complex server class motherboard.

There are a number of different BIOS types in operation as the computer boots. The "System BIOS" is resident on the motherboard and is responsible for starting up all the hardware and mapping in the resources (like the I/O) so that they are available to the CPU. The "Video BIOS" is resident on the graphics cards. It is responsible for booting the GPU and for informing the System BIOS which resources will be required for the GPU to operate correctly.

The System BIOS requires an I/O enabled ImageDP4 if it is used as the boot device, i.e. it provides the graphics output that displays the BIOS boot messages. However the Windows driver for the ImageDP4 has been designed so that it does not require I/O. We can therefore use two types of Video BIOS for the ImageDP4, one which requests I/O (and which can be used as a boot device) and one which does not. This allows us to increase the number of ImageDP4 cards which can be used in a system.

To find out more about how to choose the correct BIOS for your requirements and how to update the BIOS for the ImageDP4, download a PDF from our website by clicking on the link below or select it from the Read Me file on the Software Installation Suite CD supplied with your ImageDP4 card:

www.datapath.co.uk

Use of the SBC's onboard graphics adaptor

Onboard Graphics Adaptor used as Control Screen

The VSN970 is shipped with the BIOS configured to boot off the onboard graphics device. This output can then be used as the control screen for a typical wall configuration.

To set the system to boot on the onboard graphics device ("Initiate Graphic Adapter" - IGD), enter setup from the boot screen by pressing <F2> as prompted.

In the BIOS setup utility select:

Advanced>Graphic Configuration>Graphics Configuration>Primary Display Selection>Initiate Graphic Adapter - [IGD]

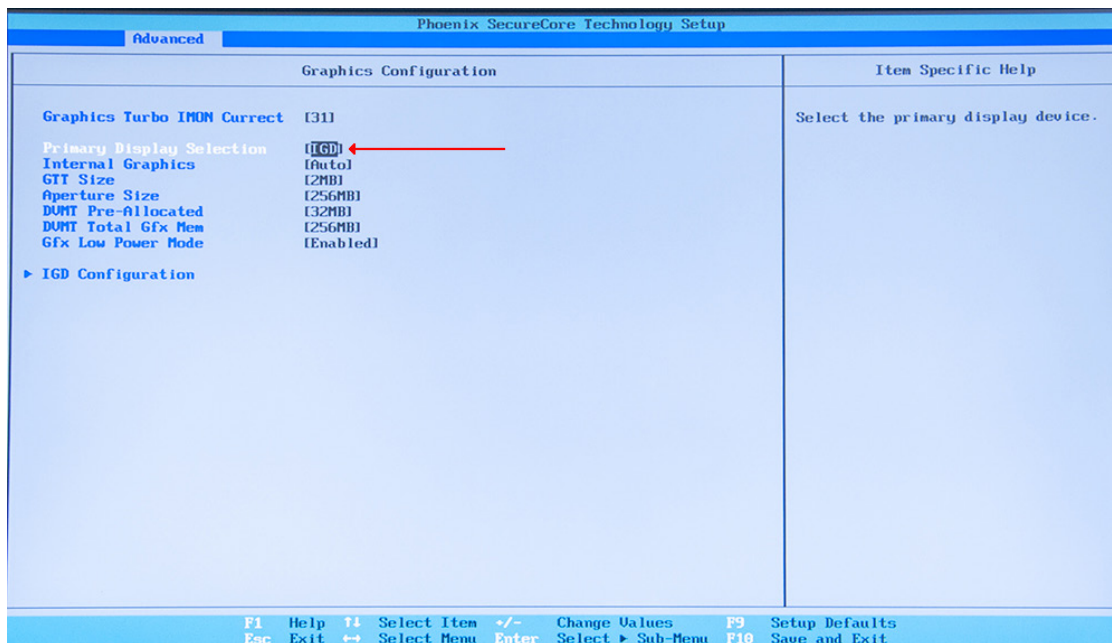

Fig.4

Onboard Graphics Adaptor Disabled

If you do not require a control screen, then you should disable the integrated graphics as described below.

Connect a monitor to the onboard graphics device output and enter setup from the boot screen by pressing <F2> as prompted.

In the BIOS setup utility select:

Advanced>Graphic Configuration>Graphics Configuration>Primary Display Selection [PEG/PCI]

Once the Primary Display selection PEG/PCI has been made the "Above 4GB MMIO BIOS assignment" should be disabled.

Navigate to:

Advanced>Graphic Configuration>PEG Port Configuration> Above 4GB MMIO BIOS assignment - Disabled

By opting to disable the on board graphics adapter, this reduces the maximum number of screens available from 64 to 32.

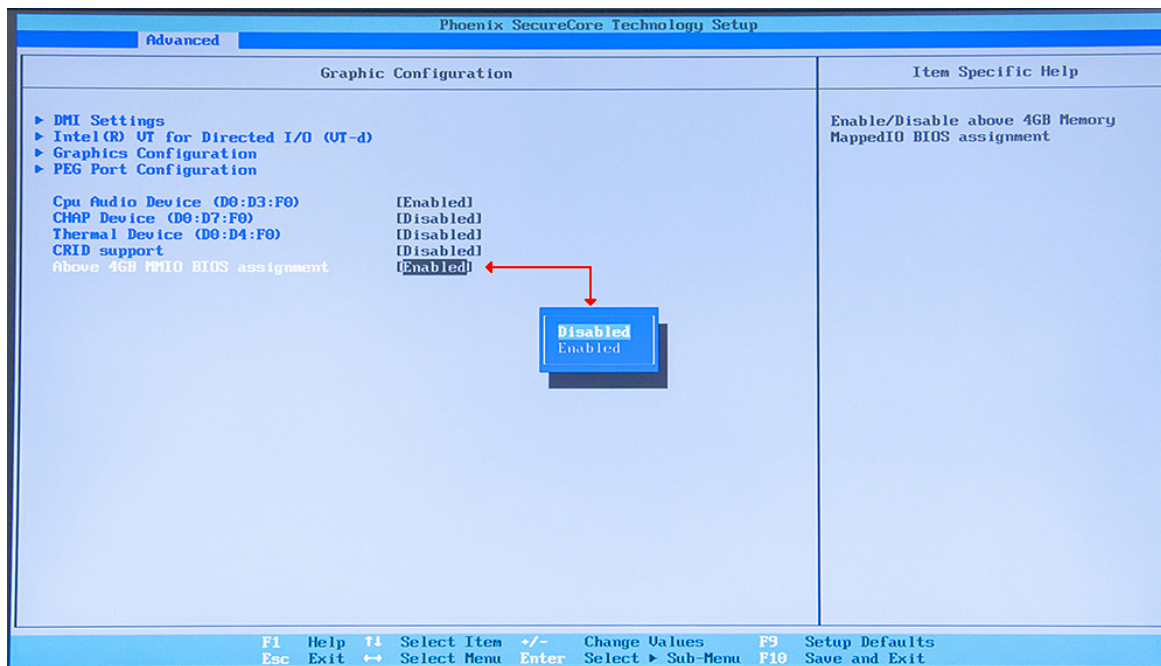

Fig.5

The system will then boot on an output from the graphics card identified last by the PCI Bus.

Hardware Installation

Your VSN970 may have cards that require installation as cards may have been shipped separately.

To ensure your cards are installed correctly please consult the product user manual for detailed instructions. User manuals for cards are located on the Software Installation Suite CD.

VSN970 Backplane Layout

The VSN970 is fitted with the Datapath Express9-G3 backplane. The backplane consists of:

- One PICMG1.3 slot
- One x8 lane PCIe slot
- Eight x4 lane PCIe slots

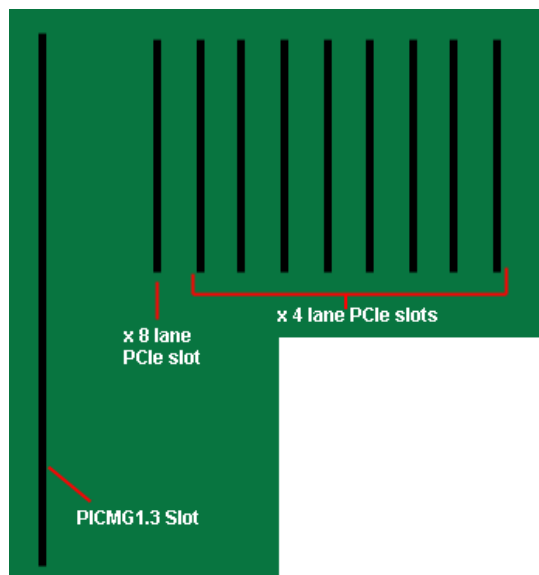

Fig.6

PCIe Port Width

PICMG	X8
SLOT 1	X8
SLOT 2	X4
SLOT 3	X4
SLOT 4	X4
SLOT 5	X4
SLOT 6	X4
SLOT 7	X4
SLOT 8	X4
SLOT 9	X4

Express9-G3 Connectors

FAN1, FAN2, FAN3	4 pin fan speed control header Pin 1 : GND Pin 2 : +12V Pin 3 : TACH Pin 4 : PWM	J11, J12	SATA 2.0 Pin 1 : 0V Pin 2 : A+ Pin 3 : A- Pin 4 : 0V Pin 5 : B- Pin 6 : B+ Pin 7 : 0V
FAN5, FAN6, FAN7, FAN8	3 pin fan header (non speed control) Pin 1 : GND Pin 2 : +12V Pin 3 : N/C	J13	Debug I2C Pin 1 : SCL Pin 2 : 0V Pin 3 : SDA Pin 4 : N/C Pin 5 : N/C Pin 6 : N/C Pin 7 : N/C Pin 8 : N/C Pin 9 : N/C Pin10 : 0V
FAN9	2 pin fan header (non speed control) Pin 1 : GND Pin 2 : +12V	J14, J15	USB 2.0 Pin 1 : +5V Pin 2 : +5V Pin 3 : USB1N Pin 4 : USB0N Pin 5 : USB1P Pin 6 : USB0P Pin 7 : 0V Pin 8 : 0V Pin 9 : N/C Pin10 : N/C
J1,J2	ATX Power Connector Pin 1 : +3.3V Pin13 : +3.3V Pin 2 : +3.3V Pin14 : -12V Pin 3 : 0V Pin15 : 0V Pin 4 : +5V Pin16 : PS_ON# Pin 5 : 0V Pin17 : 0V Pin 6 : +5V Pin18 : 0V Pin 7 : 0V Pin19 : 0V Pin 8 : PWR_ON Pin20 : N/C Pin 9 : +12V Pin21 : +5V Pin10 : +12V Pin22 : +5V Pin11 : +12V Pin23 : +5V Pin12 : +3.3V Pin24 : 0V	J16	Panel LED Connector Pin 1 : LED Anode Pin 2 : LED Cathode
J7	Panel Power Pushbutton Connector Pin 1 : PWRBUT Pin 2 : 0V	J17	PLX EEPROM Select Pin 1-2 : EEPROM U4 Pin 2-3 : EEPROM U14
J8	Panel Reset Pushbutton Connector Pin 1 : SHB_RST Pin 2 : 0V	J18	AUX Power Connector Pin 1 : 0V Pin 5 : +12V Pin 2 : 0V Pin 6 : +12V Pin 3 : 0V Pin 7 : +12V Pin 4 : 0V Pin 8 : +12V
J6	AUX Power Connector Pin 1 : 0V Pin 5 : +12V Pin 2 : 0V Pin 6 : +12V Pin 3 : 0V Pin 7 : +12V Pin 4 : 0V Pin 8 : +12V	J19	PLX I2C Pin 1 : SCL Pin 2 : 0V Pin 3 : SDA Pin 4 : N/C Pin 5 : N/C Pin 6 : N/C Pin 7 : N/C Pin 8 : N/C Pin 9 : N/C Pin10 : 0V
J10	JTAG Pin 1 : TCK Pin 2 : 0V Pin 3 : TDO Pin 4 : +3V Pin 5 : TMS Pin 6 : +3V Pin 7 : N/C Pin 8 : TRST Pin 9 : TDI Pin10 : 0V	J20	PLX Debug Speed Select Pin 1-2 : All slots Gen 1 Pin 2-3 : All slots Gen 3

Connecting Expansion Chassis (VSN900X)

It is possible to connect a VSN900X expansion chassis to the VSN970 thereby increasing the number of PCIe slots available.

The following diagram illustrate how this can be achieved:

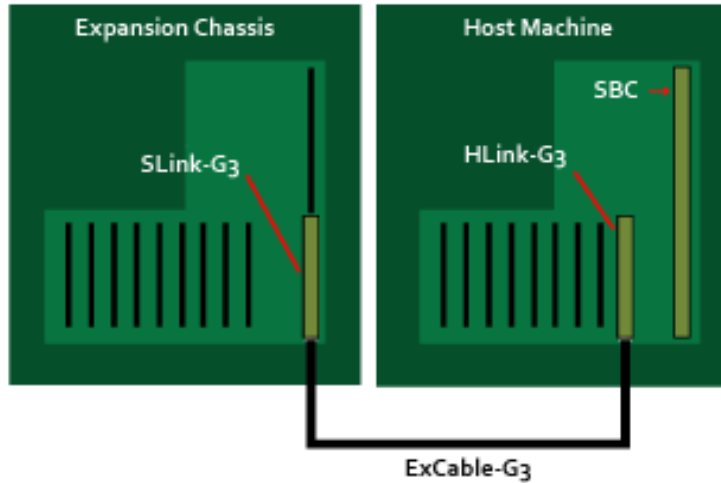

Fig.7

Connect the chassis by installing HLink-G3 and SLink-G3 cards in the VSN970 and VSN900X and connecting the two cards using the Ex-Cable-G3.

The HLink-G3 and Slink-G3 cards are factory installed into a system as a pair. When connecting expansion chassis ensure that the pair labelled Link1 are connected using the ExCable-G3, the pair labelled Link2 are connected together and so on. In the event that this is not possible, connect the expansion chassis to the host machine and re-install the Datapath Driver Install to reset the pairings.

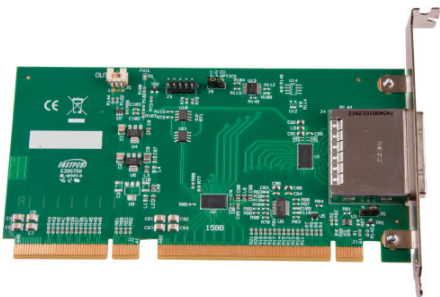

Fig.8: SLink-G3



Fig.9: ExCable-G3

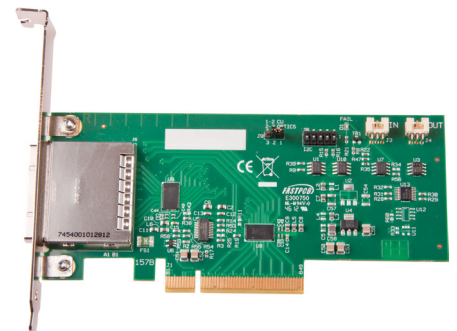

Fig.10: HLink-G3

When connecting a VSN900X expansion chassis to a VSN970 machine the HLink-G3 card in the VSN970 must be installed into the x8 slot. The SLink-G3 card in the VSN900X should be installed in the PICMG1.3 SBC slot.

Connect the HLink-G3 and SLink-G3 cards using the ExCable-G3.

VSN970 LED's

The VSN970 and VSN900X have an LED for each PCIe slot and the PICMG1.3 SBC slot.

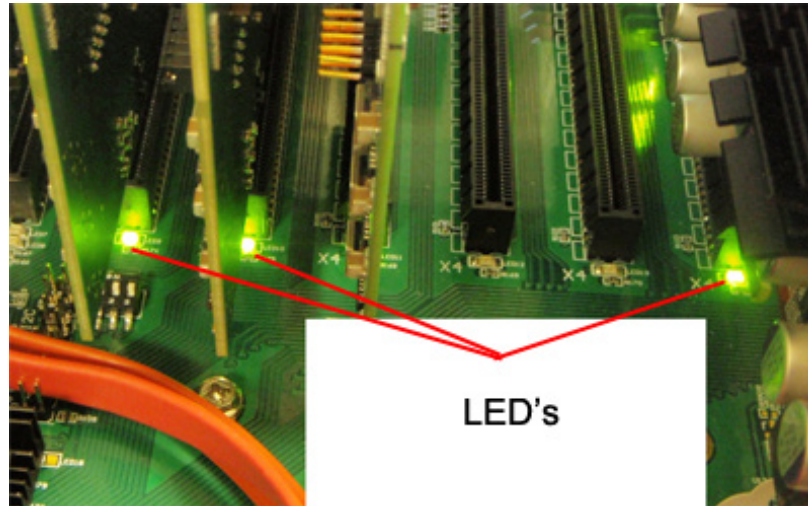

Fig.10

The LED's indicate the following:

LED1	ON = +5V Standby Voltage present
LED2	ON = +5V supply present
LED3	ON = +12V supply present
LED4	ON = +3.3V supply present
LED5	ON = PICMG link speed = G3, FLASH-FAST = G2, FLASH-SLOW = G1
LED7	ON = PCIe Slot 1 link speed = G3, FLASH-FAST = G2, FLASH-SLOW = G1
LED9	ON = PCIe Slot 2 link speed = G3, FLASH-FAST = G2, FLASH-SLOW = G1
LED10	ON = PCIe Slot 3 link speed = G3, FLASH-FAST = G2, FLASH-SLOW = G1
LED11	ON = PCIe Slot 4 link speed = G3, FLASH-FAST = G2, FLASH-SLOW = G1
LED12	ON = PCIe Slot 5 link speed = G3, FLASH-FAST = G2, FLASH-SLOW = G1
LED13	ON = PCIe Slot 6 link speed = G3, FLASH-FAST = G2, FLASH-SLOW = G1
LED14	ON = PCIe Slot 7 link speed = G3, FLASH-FAST = G2, FLASH-SLOW = G1
LED15	ON = PCIe Slot 8 link speed = G3, FLASH-FAST = G2, FLASH-SLOW = G1
LED16	Not Used

No LED's flashing indicates that lane width has not been established. The LED's will not flash on slots where no cards are installed.

Filter Maintenance

The system filter is an integral part of the wall controller and as such it needs to be maintained correctly. Failure to maintain the filter can result in the system overheating and causing it to fail. In normal operating conditions the filter should be removed and cleaned every 3 months. However, this 3 month period is a guide only and it can be increased to every 6 months or decreased to one month depending on the levels of dust in the environment the system is operating in.

It is recommended that the condition of the filter is checked at regular intervals.

The filter can be removed and cleaned whilst the system is in operation, system shutdown is not necessary.

Note:

Failure to maintain the system filter could result in damage to your system and invalidate the warranty.

Remove the Filter

Open the front panel door and locate the filter housing screw, remove the screw and lift the filter housing away from the front panel.



Remove the filter from the housing and shake it to remove any dust particles, this should not be done in close proximity to the system to avoid dust ingress. Ideally, the filter should be cleaned using a vacuum cleaner.

Note: The filter should never be immersed in water or any other cleaning liquid.

For advice on replacement filters, please contact Datapath Ltd.

Datapath Limited

Datapath has a long and very successful history in the computer graphics industry. Datapath has been designing and supplying high performance, high quality graphics display systems to the world's largest and most demanding companies and institutions since 1982. Datapath was one of the founding companies of multi-screen Windows acceleration using single and multi board solutions. Now using the very latest display technology Datapath offers some of the world's leading multi screen graphics accelerators for the most demanding applications.

As new technology advances, so we at Datapath improve the performance and functionality of both our hardware and software to give our customers more. Following a continuous development program, we pride ourselves on our support and responsive nature towards all our customers and their changing needs. As more sophisticated equipment and techniques become readily available, so we are there to exploit the power and potential that this technology presents.

Technical Support

Registered Users can access our technical support line using, email, and the Support page on the Datapath Web Site, usually with a response within 24 hours (excluding weekends).

Via Email

Send an email to support@datapath.co.uk with as much information about your system as possible. To enable a swift response we need to know the following details:

Specification of the PC - including processor speed

Operating System

Application Software

Datapath Hardware / Software

The exact nature of the problem - and please be as specific as possible.

Please quote version and revision numbers of hardware and software in use wherever possible.

Copyright Statement

© Datapath Ltd., England, 2014

Datapath Limited claims copyright on this documentation. No part of this documentation may be reproduced, released, disclosed, stored in any electronic format, or used in whole or in part for any purpose other than stated herein without the express permission of Datapath Limited.

Whilst every effort is made to ensure that the information contained in this on-line help is correct, Datapath Limited make no representations or warranties with respect to the contents thereof, and do not accept liability for any errors or omissions. Datapath reserves the right to change specification without prior notice and cannot assume responsibility for the use made of the information supplied. Datapath Limited acknowledges all registered trademarks used within this documentation.

FCC Statement

This equipment has been tested and found to comply with the limits for a Class A digital device, pursuant to part 15 of the FCC Rules. These limits are designed to provide reasonable protection against harmful interference when the equipment is operated in a commercial environment. This equipment generates, uses, and can radiate radio frequency energy and, if not installed and used in accordance with the instruction manual, may cause harmful interference to radio communications. Operation of this equipment in a residential area is likely to cause harmful interference in which case the user will be required to correct the interference at their own expense.

Changes or modifications not expressly approved by the party responsible for compliance, could void the user's authority to operate the equipment.

UK Headquarters and Main Sales Office

Datapath Ltd.,
Bemrose House, Bemrose Park, Wayzgoose Drive
Derby, DE21 6XQ, UK
Tel: +44 (0) 1332 294441
Fax: +44 (0) 1332 290667

Email: sales@datapath.co.uk
www.datapath.co.uk

Index

B

Backplane Layout 11

BIOS setup 9

C

Cable 3

Capture channels 6

Copyright 15

D

Dimensions 7

E

Email 15

Expansion chassis 13

F

Features 6

Filter Maintenance 15

I

Introduction 4

L

LED's 14

M

Maintenance 3

Models 7

Multi-unit rack assembly 3

O

Onboard Graphics 9

Operating system 7

P

Packing box 5

Power supply 3

R

RPSU 7

T

Technical support 15

W

Wall Control 6

Warranty 7