



LCD Monitor User Manual

DesignVue Designer Monitor | PD Series

AQCOLOR®
Colors You Can Trust

Copyright

Copyright © 2020 by BenQ Corporation. All rights reserved. No part of this publication may be reproduced, transmitted, transcribed, stored in a retrieval system or translated into any language or computer language, in any form or by any means, electronic, mechanical, magnetic, optical, chemical, manual or otherwise, without the prior written permission of BenQ Corporation.

Disclaimer

BenQ Corporation makes no representations or warranties, either expressed or implied, with respect to the contents hereof and specifically disclaims any warranties, merchantability or fitness for any particular purpose. Further, BenQ Corporation reserves the right to revise this publication and to make changes from time to time in the contents hereof without obligation of BenQ Corporation to notify any person of such revision or changes.

The performance of flicker-free may be affected by external factors such as poor cable quality, unstable power supply, signal interference, or poor grounding, and not limited to the above mentioned external factors. (Applicable for flicker-free models only.)

BenQ ecoFACTS

BenQ has been dedicated to the design and development of greener product as part of its aspiration to realize the ideal of the "Bringing Enjoyment 'N Quality to Life" corporate vision with the ultimate goal to achieve a low-carbon society. Besides meeting international regulatory requirement and standards pertaining to environmental management, BenQ has spared no efforts in pushing our initiatives further to incorporate life cycle design in the aspects of material selection, manufacturing, packaging, transportation, using and disposal of the products. BenQ ecoFACTS label lists key eco-friendly design highlights of each product, hoping to ensure that consumers make informed green choices at purchase. Check out BenQ's CSR Website at <http://csr.BenQ.com/> for more details on BenQ's environmental commitments and achievements.



Product support

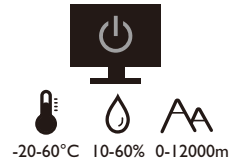
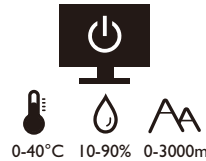
This document aims to provide the most updated and accurate information to customers, and thus all contents may be modified from time to time without prior notice. Please visit the website for the latest version of this document and other product information. Available files vary by model.

1. Make sure your computer is connected to the Internet.
2. Visit the local website from Support.BenQ.com. The website layout and content may vary by region/country.
 - User manual and related document
 - Drivers and applications
 - (EU only) Dismantled information: Available on the user manual download page. This document is provided based on Regulation (EU) 2019/2021 to repair or recycle your product. Always contact the local customer service for servicing within the warranty period. If you wish to repair an out-of-warranty product, you are recommended to go to a qualified service personnel and obtain repair parts from BenQ to ensure compatibility. Do not disassemble the product unless you are aware of the consequences. If you cannot find the dismantled information on your product, contact the local customer service for assistance.

Power safety



Please follow these safety instructions for best performance, and long life for your monitor.



- The AC plug isolates this equipment from the AC supply.
- The power supply cord serves as a power disconnect device for pluggable equipment. The socket outlet should be installed near the equipment and be easily accessible.
- This product should be operated from the type of power indicated on the marked label. If you are not sure of the type of power available, consult your dealer or local power company.
- The Class I pluggable equipment Type A must be connected to protective earth.
- An approved power cord greater or equal to H03VV-F or H05VV-F, 2G or 3G, 0.75mm² must be used.
- Use only the power cord provided by BenQ. Never use a power cord that appears to be damaged or frayed.

For Germany only:

- (If the weight of the product is less than or equal to 3 kg) An approved power cord greater or equal to H03VV-F, 3G, 0.75mm² must be used.
- (If the weight of the product is more than 3 kg) An approved power cord greater or equal to H05VV-F or H05RR-F, 3G, 0.75mm² must be used.
- (If a remote control is provided) RISK OF EXPLOSION IF BATTERY IS REPLACED BY AN INCORRECT TYPE. DISPOSE OF USED BATTERIES ACCORDING TO THE INSTRUCTIONS.

For models with adapter:

- Use only the power adapter supplied with your LCD Monitor. Use of another type of power adapter will result in malfunction and/or danger.
- Allow adequate ventilation around the adapter when using it to operate the device or charge the battery. Do not cover the power adapter with paper or other objects that will reduce cooling. Do not use the power adapter while it is inside a carrying case.
- Connect the power adapter to a proper power source.
- Do not attempt to service the power adapter. There are no service parts inside. Replace the unit if it is damaged or exposed to excess moisture.

Care and cleaning

- Do not place the monitor face down on the floor or a desk surface directly. Otherwise, scratches on the panel surface may occur.
- The equipment is to be secured to the building structure before operation.
- (For models that support wall or ceiling mounting)
 - Install your monitor and monitor mounting kit on a wall with flat surface.
 - Ensure that the wall material and the standard wall mount bracket (purchased separately) are stable enough to support the weight of the monitor.
 - Turn off the monitor and the power before disconnecting the cables from the LCD monitor.
- Always unplug the product from the power outlet before cleaning. Clean the LCD monitor surface with a lint-free, non-abrasive cloth. Avoid using any liquid, aerosol or glass cleaners.
- Slots and openings on the back or top of the cabinet are for ventilation. They must not be blocked or covered. Your monitor should never be placed near or over a radiator or heat sources, or in a built-in installation unless proper ventilation is provided.
- Do not place heavy loads on the monitor to avoid possible personal injury or damage to the monitor.
- Consider keeping the box and packaging in storage for use in the future when you may need to transport the monitor.
- Refer to the product label for information on power rating, manufacture date, and identification markings.

Servicing




- Do not attempt to service this product yourself, as opening or removing covers may expose you to dangerous voltages or other risks. If any of the above mentioned misuse or other accident such as dropping or mishandling occurs, contact qualified service personnel for servicing.
- Contact your place of purchase or visit the local website from Support.BenQ.com for more support.



Caution

- The monitor should be 50 ~ 70 cm (20 ~ 28 inches) away from your eyes.
- Looking at the screen for an extended period of time causes eye fatigue and may deteriorate your eyesight. Rest your eyes for 5 ~ 10 minutes for every 1 hour of product use.
- Reduce your eye strain by focusing on objects far way.
- Frequent blinking and eye exercise help keep your eyes from drying out.

Typographics

Icon / Symbol	Item	Meaning
	Warning	Information mainly to prevent the damage to components, data, or personal injury caused by misuse and improper operation or behavior.
	Tip	Useful information for completing a task.
	Note	Supplementary information.

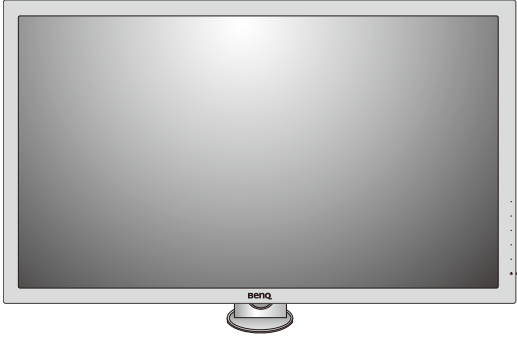
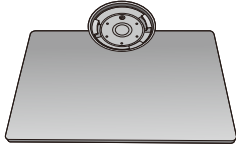

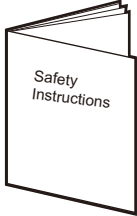

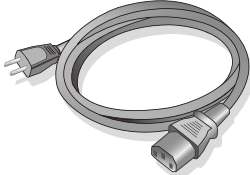
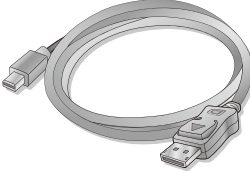
In this document, the steps needed to reach a menu may be shown in condensed form, for example: **Menu > System > Information.**

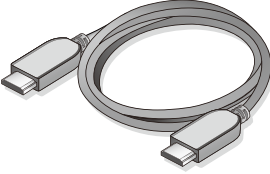
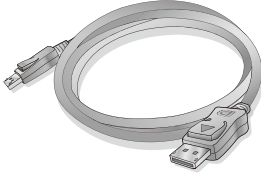
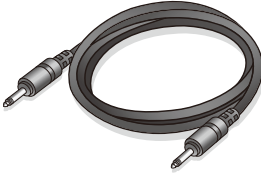
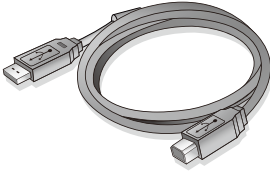

Table of Contents

Copyright	2
Product support	3
Getting started	8
Getting to know your monitor	10
Front view	10
Back view.....	10
Connection	11
How to assemble your monitor hardware	12
How to detach the base	17
Adjusting the monitor height	19
Rotating the monitor	20
Viewing angle adjustment	21
Using the monitor wall mounting kit	22
Getting the most from your BenQ monitor	23
Downloading the LCD Monitor driver files from the Internet.....	23
How to install the monitor on a new computer	24
How to upgrade the monitor on an existing computer	25
How to install on Windows 10 system	26
How to install on Windows 8 (8.1) system	27
How to install on Windows 7 system	28
How to adjust your monitor	29
The control panel.....	29
Basic menu operation	30
Customizing the hot keys.....	31
Adjusting display mode.....	32
Choosing an appropriate picture mode.....	32
Working with DualView	32
Navigating the main menu	33
Display menu	34
Picture menu	35
Picture Advanced menu	37
Audio menu	40
System menu	41
Troubleshooting	44
Frequently asked questions (FAQ).....	44
Need more help?	46

Getting started

When unpacking please check you have the following items. If any are missing or damaged, please contact the place of purchase for a replacement.

BenQ LCD Monitor	
Monitor Base	
Quick Start Guide	
Safety Instructions	
Regulatory Statements	
Power Cord (Picture may differ from product supplied for your region.)	
Video Cable: DP to mini DP	

Video Cable: HDMI	
Video Cable: DP (Optional accessory)	
Audio Cable (Optional accessory)	
USB Cable	
Headphone hook	



• Available accessories and the pictures shown here may differ from the actual contents and the product supplied for your region. And the package contents may subject to change without prior notice. For cables that are not supplied with your product, you can purchase them separately.

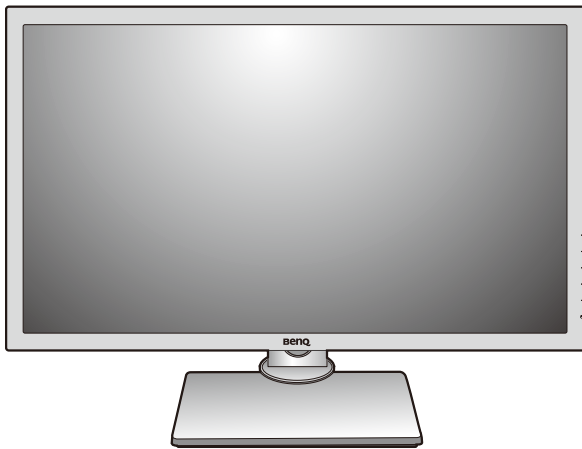
• Consider keeping the box and packaging in storage for use in the future when you may need to transport the monitor. The fitted foam packing is ideal for protecting the monitor during transport.



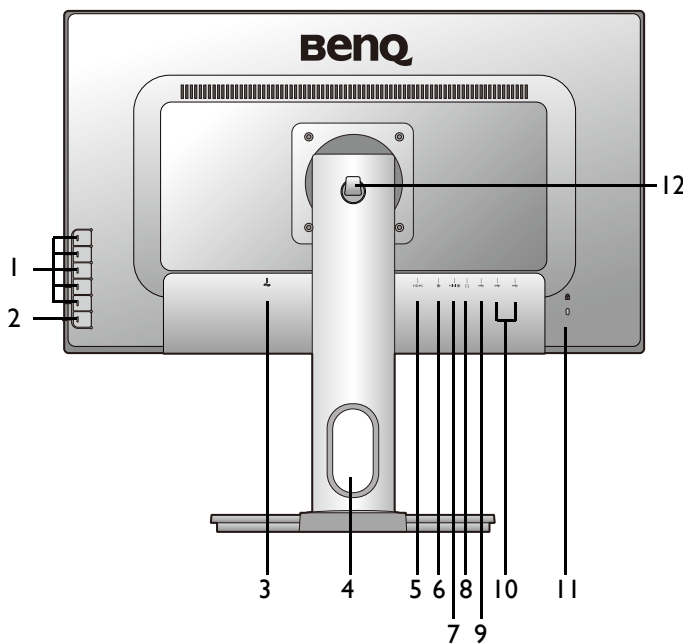
Always keep the product and accessories out of reach of small children.

Getting to know your monitor

Front view



Back view



1. Control buttons
2. Power button
3. AC power input jack
4. Cable management hole
5. HDMI socket
6. DisplayPort socket
7. Mini DisplayPort socket
8. Headphone jack
9. USB 2.0 port (upstream; connecting to the PC)
10. USB 2.0 port x 2 (downstream; connecting to USB devices)
11. Kensington lock slot
12. Headphone hook

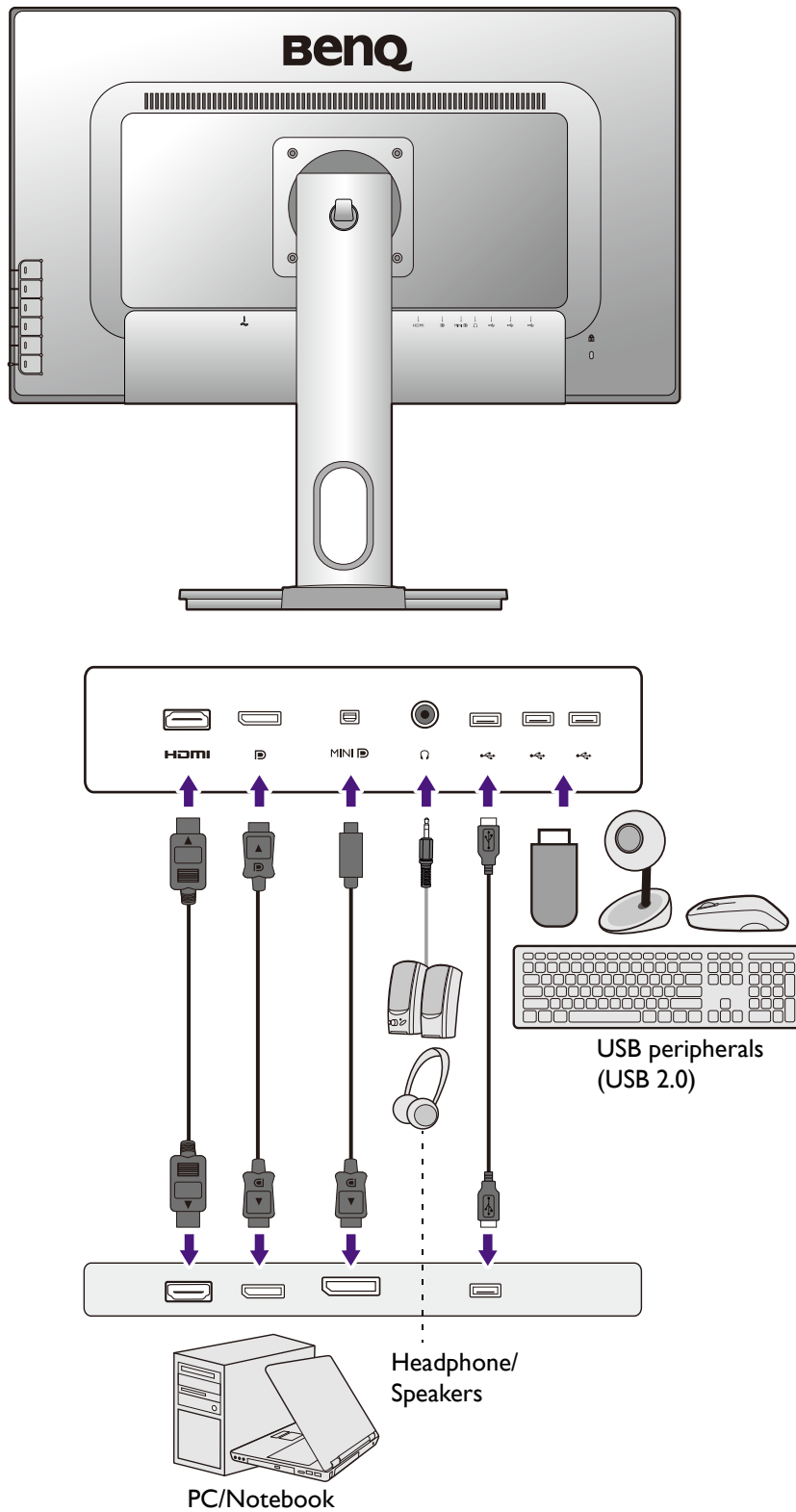


- Above diagram may vary depending on the model.
- Picture may differ from product supplied for your region.

Connection

The following connection illustrations are for your reference only. For cables that are not supplied with your product, you can purchase them separately.

For detailed connection methods, see page 14 - 15.



How to assemble your monitor hardware



- If the computer is turned on you must turn it off before continuing.
Do not plug-in or turn-on the power to the monitor until instructed to do so.
- The following illustrations are for your reference only. The location and available input and output jacks may vary depending on the purchased model.

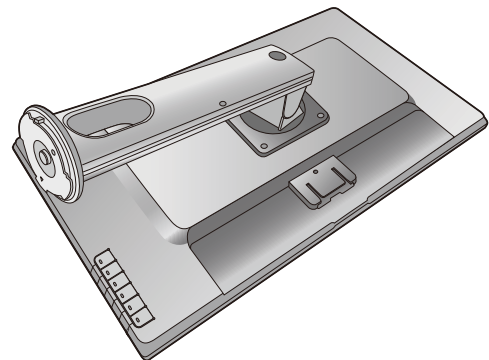
I. Attach the monitor base.



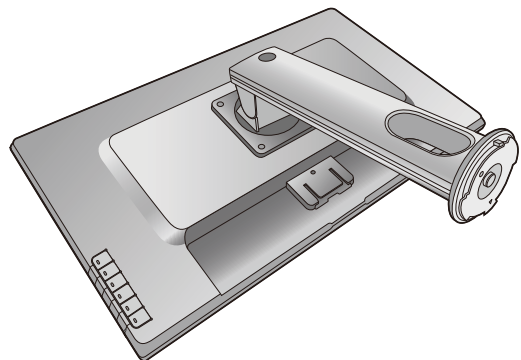
Please be careful to prevent damage to the monitor. Placing the screen surface on an object like a stapler or a mouse will crack the glass or damage the LCD substrate voiding your warranty. Sliding or scraping the monitor around on your desk will scratch or damage the monitor surround and controls.

Protect the monitor and screen by clearing a flat open area on your desk and placing a soft item like the monitor packaging bag on the desk for padding.

Gently lay the screen face down on a flat clean padded surface.

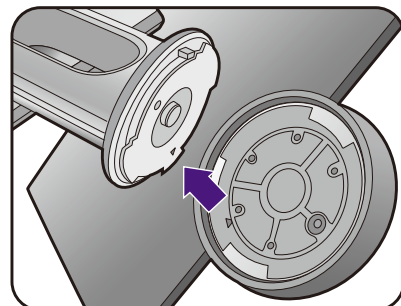


Turn the stand counterclockwise until you cannot go further.

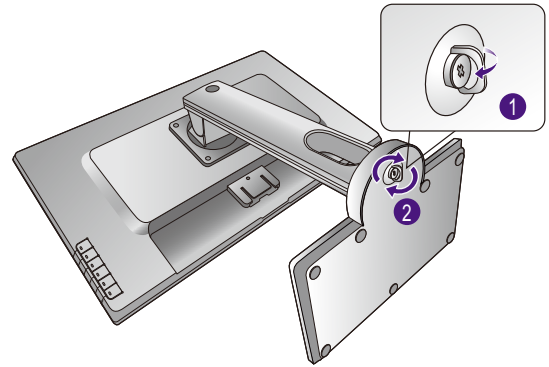


Attach the monitor stand to the monitor base as illustrated. Make sure to align the arrow on the end of the stand to the one on the monitor.

Turn the base clockwise until you cannot go further.

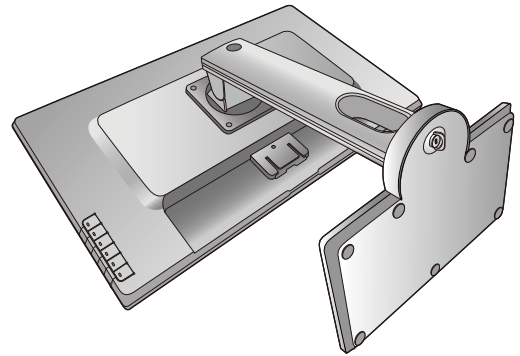


Raise the thumbscrew lid and tighten the thumbscrew as illustrated. Then push the lid back.

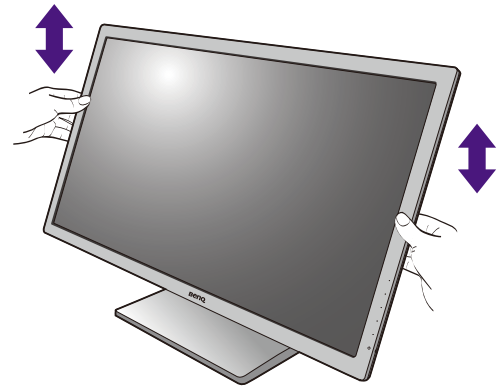


Gently attempt to pull them back apart to check that they have properly engaged.

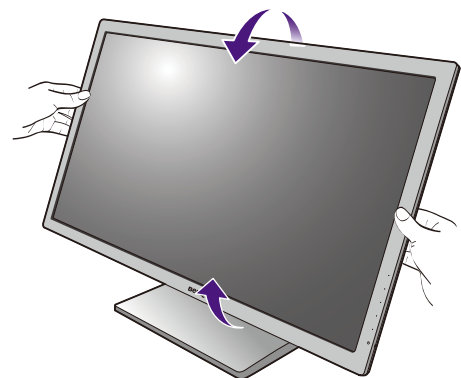
Carefully lift the monitor, turn it over and place it upright on its stand on a flat even surface.



You might want to adjust the monitor stand height. See [Adjusting the monitor height on page 19](#) for more information.



You should position the monitor and angle the screen to minimize unwanted reflections from other light sources.



2. Connect the PC video cable.

To Connect the HDMI Cable

Connect the plug of the HDMI cable to the HDMI port on the monitor. Connect the other end of the cable to the HDMI port of a digital output device.

To Connect the DP Cable

Connect the plug of the DP cable to the monitor video socket. Connect the other end of the cable to the computer video socket.

- After the monitor is powered on, if the image is not displayed, disconnect the cable. Go to **System** and **DisplayPort** on the OSD menu of the monitor and change the setting from **1.2** to **1.1**, and then connect the cable again. To go to the OSD menu, see [Basic menu operation on page 30](#).

To Connect the mini DP Cable

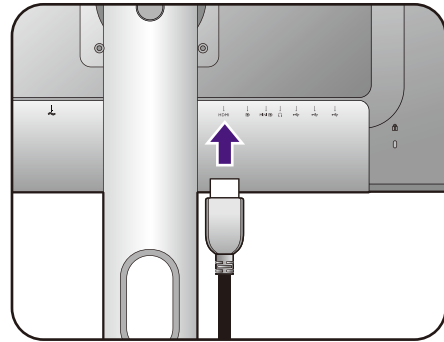
Connect the plug of the mini DP cable to the monitor video socket. Connect the other end of the cable to the computer video socket.

- The video cables included in your package and the socket illustrations on the right may vary depending on the product supplied for your region.

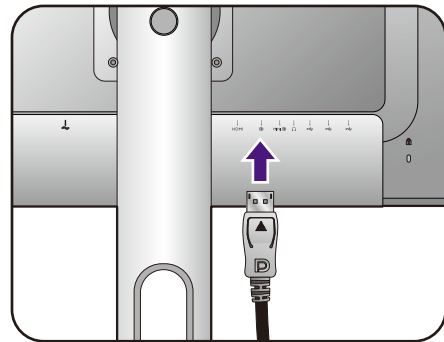
3. Connect the headphones.

You may connect headphones to the headphone jack found on the back side of the monitor.

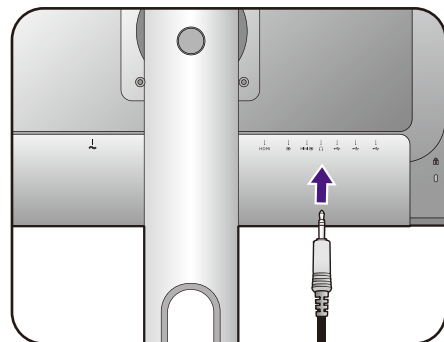
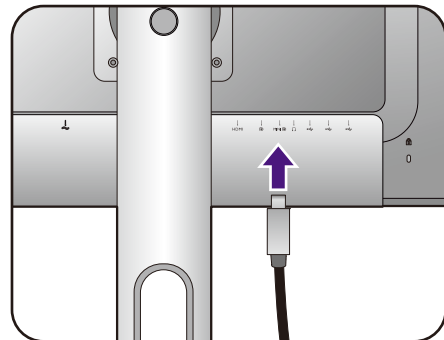
Or



Or

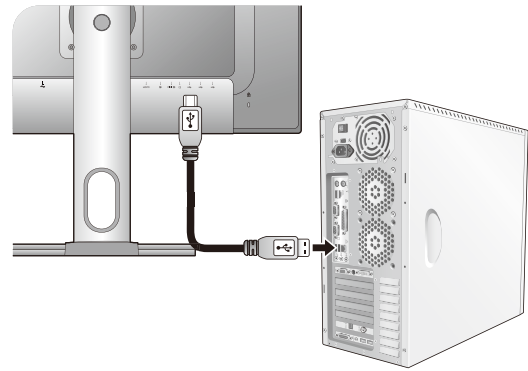


Or

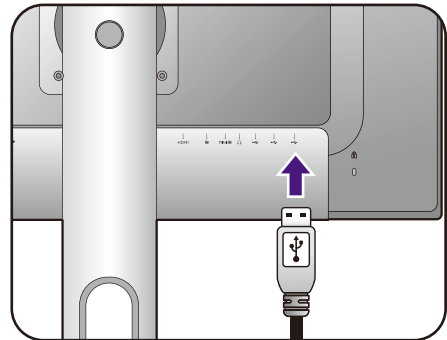


4. Connect USB devices.


Connect the USB cable between the PC and the monitor (via the upstream USB port at the back). This upstream USB port transmits data between the PC and the USB devices connected to the monitor.

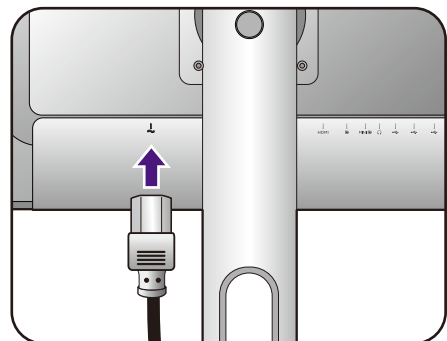


Connect USB devices via other USB ports (downstream) on the monitor. These downstream USB ports transmit data between connected USB devices and the upstream port.

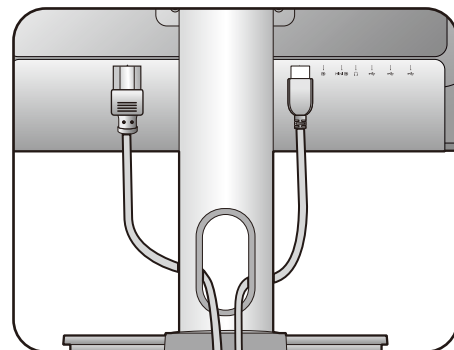


5. Connect the power cable to the monitor.

Plug one end of the power cord into the socket labelled  on the rear of the monitor. Do not connect the other end to a power outlet just yet.



6. Organize the cables.

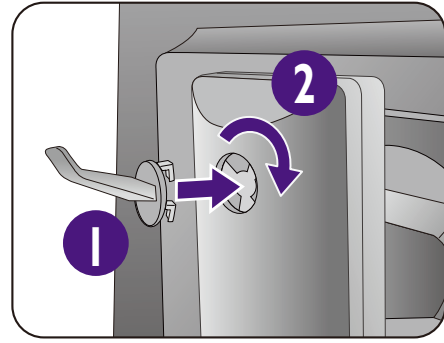


7. Install the headphone hook (optional step).

You can install the headphone hook to place your headphone. It is useful when your headphone is not in use.

Orient and align the headphone hook with the hole on the monitor stand, and attach the hook to the hole (1).

Turn the hook clockwise until you cannot go further (2). The headphone hook is ready to use.

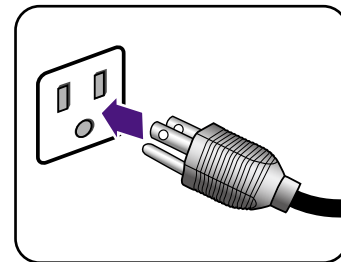


 The maximum load capacity of the headphone hook is 500g.

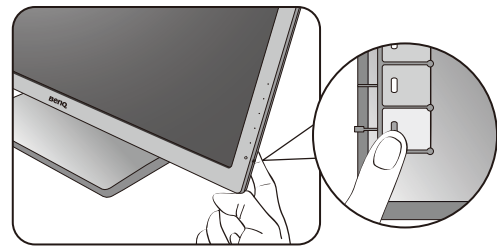
8. Connect-to and turn-on the power.

Plug the other end of the power cord into a power outlet and turn it on.

 Picture may differ from product supplied for your region.

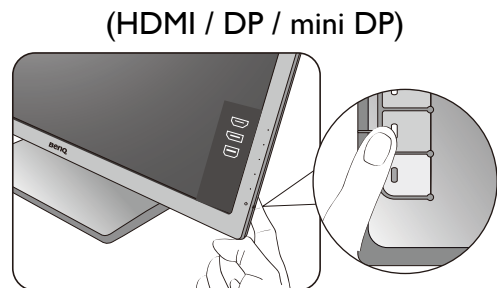



Turn on the monitor by pressing the power button on the monitor.



Turn on the computer too, and select an input source by the OSD control keys.

Turn on the computer too, and follow the instructions in [Getting the most from your BenQ monitor on page 23](#) to install the monitor software.



 To extend the service life of the product, we recommend that you use your computer's power management function.

How to detach the base

1. Prepare the monitor and area.

Turn off the monitor and the power before unplugging the power cable. Turn off the computer before unplugging the monitor signal cable.

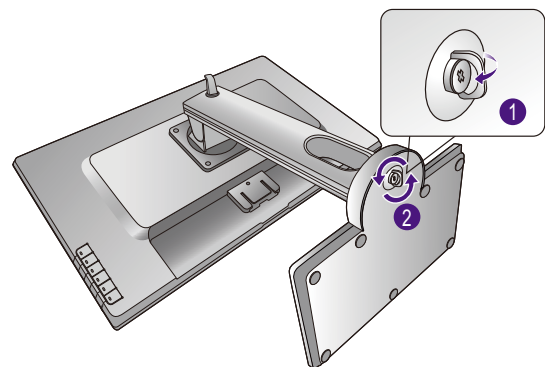
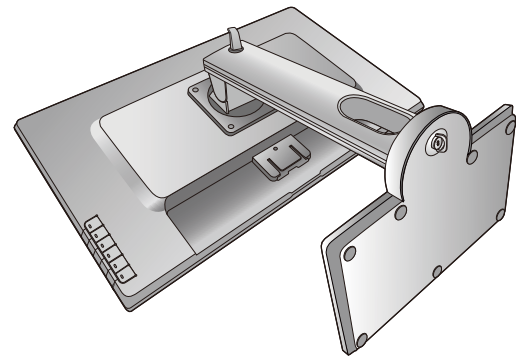
Protect the monitor and screen by clearing a flat open area on your desk and placing a soft item like a towel on the desk for padding, before laying the screen face down on a flat clean padded surface.



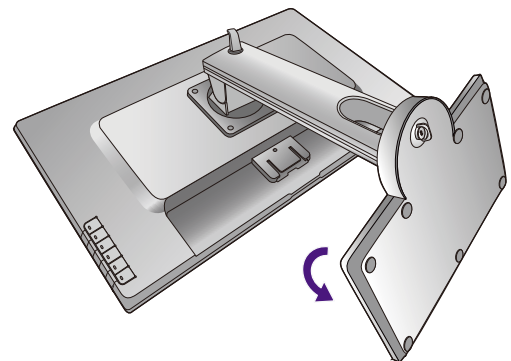
Please be careful to prevent damage to the monitor. Placing the screen surface on an object like a stapler or a mouse will crack the glass or damage the LCD substrate voiding your warranty. Sliding or scraping the monitor around on your desk will scratch or damage the monitor surround and controls.

2. Remove the monitor base.

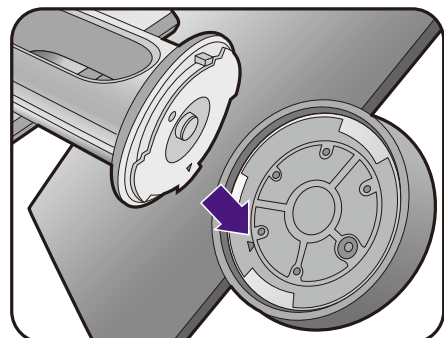
Raise the thumbscrew lid and release the thumbscrew as illustrated.



Turn the base counterclockwise until you cannot go further.

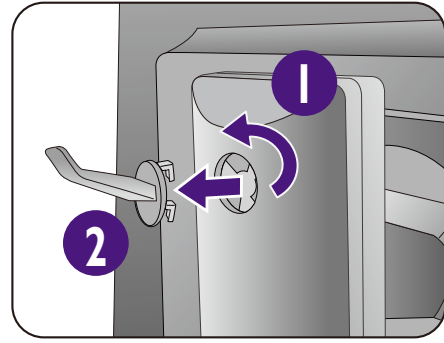


And then detach the base from the stand.



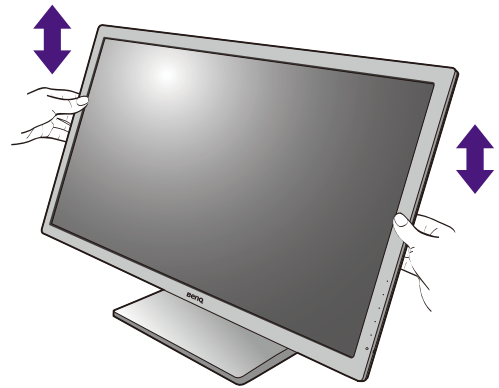


You can remove the headphone hook as illustrated. Keep the headphone hook somewhere safe.

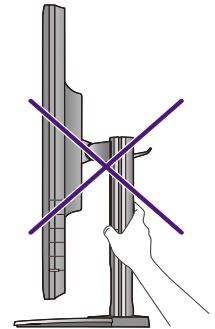
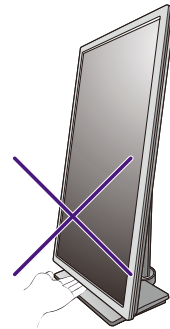


Adjusting the monitor height

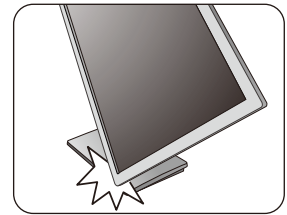
To adjust the monitor height, hold both the left and the right sides of the monitor to lower the monitor or lift it up to the desired height.



- Avoid placing hands on the upper or lower part of the height-adjustable stand or at the bottom of the monitor, as ascending or descending monitor might cause personal injuries. Keep children out of reach of the monitor while performing this operation.



- If the monitor has been rotated to portrait mode and height adjustment is desired, you should be noted that the wide screen will keep the monitor from being lowered to its minimum height.



Rotating the monitor

1. Pivot the display.

Before rotating the monitor with a portrait viewing orientation, the display has to be rotated 90 degrees.

Right-click the desktop and select **Screen resolution** from the popup menu. Select **Portrait in Orientation**, and apply the setting.



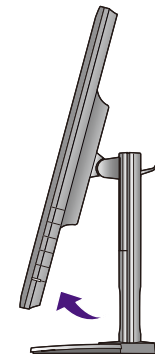
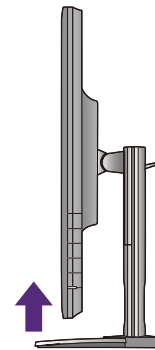
Depending on the operating system on your PC, different procedures should be followed to adjust the screen orientation. Refer to the help document of your operating system for details.

2. Fully extend the monitor and tilt it.

Gently lift the display up and extend it to the maximum extended position. Then tilt the monitor.



The monitor should be vertically extended to allow to rotate from landscape to portrait mode.



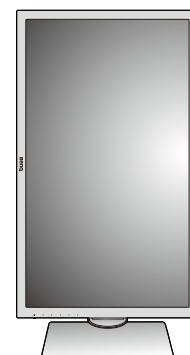
3. Rotate the monitor 90 degrees clockwise as illustrated.



To avoid the edge of the LCD display hitting the monitor base surface while it is being rotated, do tilt and extend the monitor to the highest position before you start to rotate the display. You should also make sure there are no obstacles around the monitor and there is enough room for cables.

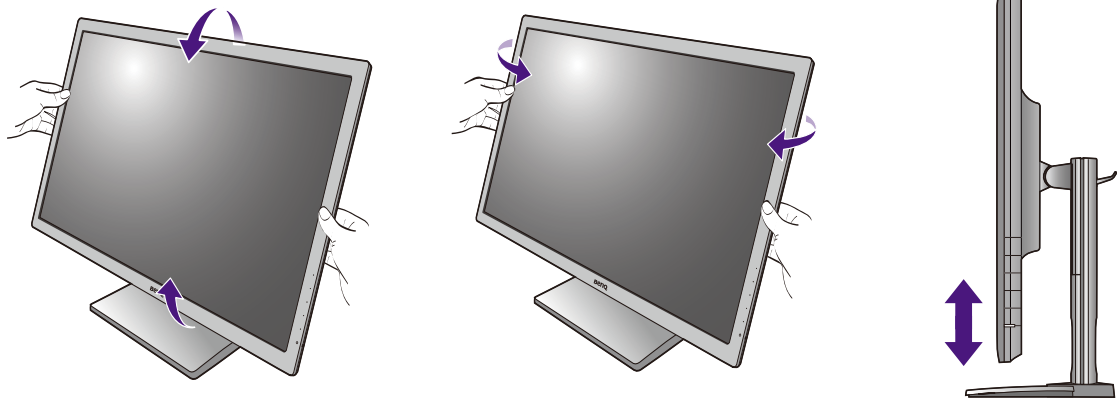


4. Adjust the monitor to the desired viewing angle.



Viewing angle adjustment

You may position the screen to the desired angle with the monitor tilt, swivel, and height adjustment functions. Check the product specifications on the website for details.



Using the monitor wall mounting kit

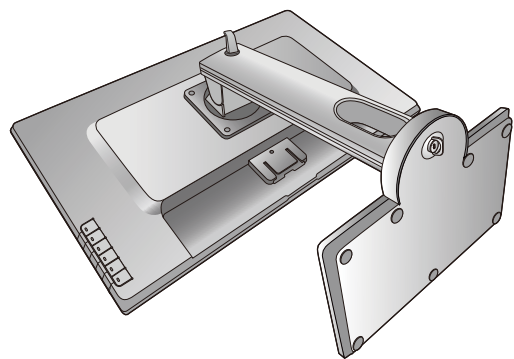
The back of your LCD monitor has a VESA standard mount with 100mm pattern, allowing the installation of a wall mount bracket. Before starting to install a monitor wall mounting kit, please read the precautions carefully.

Precautions

- Install your monitor and monitor mounting kit on a wall with flat surface.
- Ensure that the wall material and the standard wall mount bracket (purchased separately) are stable enough to support the weight of the monitor. Refer to the product specifications on the website for weight information.
- Turn off the monitor and the power before disconnecting the cables from the LCD monitor.

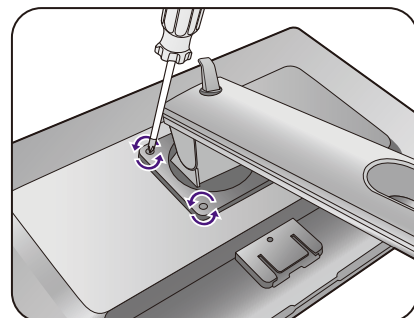
1. Remove the monitor base.

Lay the screen face down on a clean and well-padded surface. Detach the monitor base as instructed in [How to detach the base on page 17](#).



2. Remove the monitor stand.

Use a cross-pointed screwdriver to release the screws that fixing the monitor stand to the monitor. The use of a magnetic-head screwdriver is recommended to avoid of losing the screws.



In case you intend to use your monitor on the stand in the future, please keep the monitor base, monitor stand, and screws somewhere safe for future use.

3. Follow the instruction manuals of the wall mount bracket you purchased to complete the installation.



Use four M4 x 10 mm screws to fix a VESA standard wall mount bracket to the monitor. Make sure that all screws are tightened and secured properly. Consult a professional technician or BenQ service for wall mount installation and safety precautions.

Getting the most from your BenQ monitor

To gain the most benefit from your new BenQ LCD monitor, you should install the custom BenQ LCD Monitor driver software as provided on the local website. See [Downloading the LCD Monitor driver files from the Internet on page 23](#) for details.

The circumstances under which you connect and install your BenQ LCD Monitor will determine which process you need to follow to successfully install the BenQ LCD Monitor driver software. These circumstances relate to which version of Microsoft Windows you are using, and whether you are connecting the monitor and installing the software onto a new computer (without existing monitor driver software), or whether you are upgrading an existing installation (which already has existing monitor driver software) with a newer monitor.

In either case however, the very next time you turn on your computer (after connecting the monitor to your computer), Windows will automatically recognize the new (or different) hardware, and will launch its **Found New Hardware wizard**.

Follow the wizard instructions. Further details and step-by-step instructions for either an automatic (new) or upgrade (existing) installation, see:

- [How to install the monitor on a new computer on page 24](#).
- [How to upgrade the monitor on an existing computer on page 25](#).



- If you require a User Name and Password to login to your Windows computer, you must be logged on as an Administrator or as a member of the Administrators group in order to install the monitor driver software. Furthermore, if your computer is connected to a network which has security access requirements, network policy settings may prevent you from installing software on your computer.
 - To check the name of the purchased model, refer to the specification label on the back of the monitor.
-

Downloading the LCD Monitor driver files from the Internet

1. Download the correct driver files from Support.BenQ.com.
2. On your computer, have your driver files extracted into an empty folder. Remember the file location the files are extracted to.

How to install the monitor on a new computer

This instruction details the procedure for selecting and installing the BenQ LCD Monitor driver software on a new computer which has never had a monitor driver installed before. This instruction is only suitable for a computer which has never been used before, and for which the BenQ LCD Monitor is the first ever monitor to be connected to it.



If you are adding the BenQ LCD Monitor to an existing computer that has already had another monitor connected to it (and has monitor driver software installed), you should not be following these instructions. You should instead be following the instructions for [How to upgrade the monitor on an existing computer](#).

1. Follow the instructions in [How to assemble your monitor hardware on page 12](#).
When Windows starts, it will automatically detect the new monitor and launch the **Found New Hardware Wizard**. Follow the prompts until it displays the option to **Install Hardware Device Drivers**.
2. Check **Search for a suitable driver for my device** option, and click **Next**.
3. Look to confirm that the wizard has selected the correct name of your monitor and click **Next**.
4. Click **Finish**.
5. Restart the computer.

How to upgrade the monitor on an existing computer

This instruction details the procedure for manually updating the existing monitor driver software on your Microsoft Windows computer. It is currently tested as compatible for Windows 10, Windows 8 (8.1), and Windows 7 Operating System (OS).



The BenQ LCD Monitor driver for your model may well function perfectly with other versions of Windows, however, as at the time of writing, BenQ has done no testing of this driver on other versions of Windows and cannot guarantee its operation on those systems.

Installing monitor driver software involves selecting an appropriate information file (.inf) from the downloaded driver files for the particular model monitor you have connected, and letting Windows install the corresponding driver files. You need only steer it in the right direction. Windows has an Upgrade Device Driver Wizard to automate the task and guide you through the file selection and installation process.

See:

- [How to install on Windows 10 system on page 26](#)
- [How to install on Windows 8 \(8.1\) system on page 27](#)
- [How to install on Windows 7 system on page 28.](#)

How to install on Windows 10 system

1. Open **Display Properties**.

Go to **Start, Settings, Devices, Devices and Printers** and right-click the name of your monitor from the menu.

2. Select **Properties** from the menu.

3. Click the **Hardware** tab.

4. Click **Generic PnP Monitor**, and then the **Properties** button.

5. Click the **Driver** tab and the **Update Driver** button.

6. In the **Update Driver Software** window, select the option **Browse my computer for driver software**.

7. Click **Browse** and locate the driver files downloaded from the Internet as instructed in [Downloading the LCD Monitor driver files from the Internet on page 23](#).

8. Click **Close**.

You may be prompted to restart your computer after the driver update is complete.

How to install on Windows 8 (8.1) system

1. Open **Display Properties**.

Move the cursor to the lower-right of the screen or press the **Windows + C** buttons on the keyboard to bring up the **Charm** bar. Go to **Settings, Control Panel, Devices and Printers** and right-click the name of your monitor from the menu.

Alternatively, right-click the desktop and select **Personalize, Display, Devices and Printers**, and right-click the name of your monitor from the menu.

2. Select **Properties** from the menu.

3. Click the **Hardware** tab.

4. Click **Generic PnP Monitor**, and then the **Properties** button.

5. Click the **Driver** tab and the **Update Driver** button.

6. In the **Update Driver Software** window, select the option **Browse my computer for driver software**.

7. Click **Browse** and locate the driver files downloaded from the Internet as instructed in [Downloading the LCD Monitor driver files from the Internet on page 23](#).

8. Click **Close**.

You may be prompted to restart your computer after the driver update is complete.

How to install on Windows 7 system

1. Open **Display Properties**.

Go to **Start, Control Panel, Hardware and Sound, Devices and Printers** and right-click the name of your monitor from the menu.

Alternatively, right-click the desktop and select **Personalize, Display, Devices and Printers**, and right-click the name of your monitor from the menu.

2. Select **Properties** from the menu.

3. Click the **Hardware** tab.

4. Click **Generic PnP Monitor**, and then the **Properties** button.

5. Click the **Driver** tab and the **Update Driver** button.

6. In the **Update Driver Software** window, select the option **Browse my computer for driver software**.

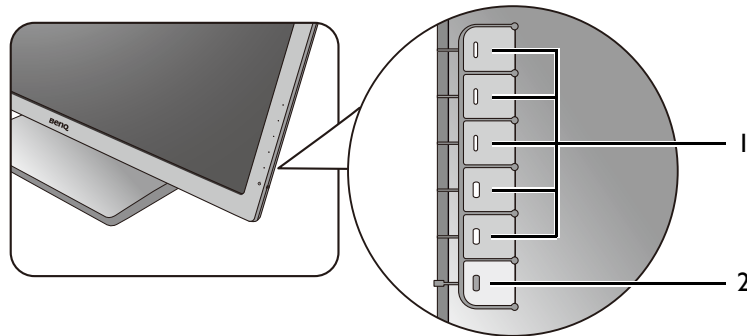
7. Click **Browse** and locate the driver files downloaded from the Internet as instructed in [Downloading the LCD Monitor driver files from the Internet on page 23](#).

8. Click **Close**.

You may be prompted to restart your computer after the driver update is complete.

How to adjust your monitor

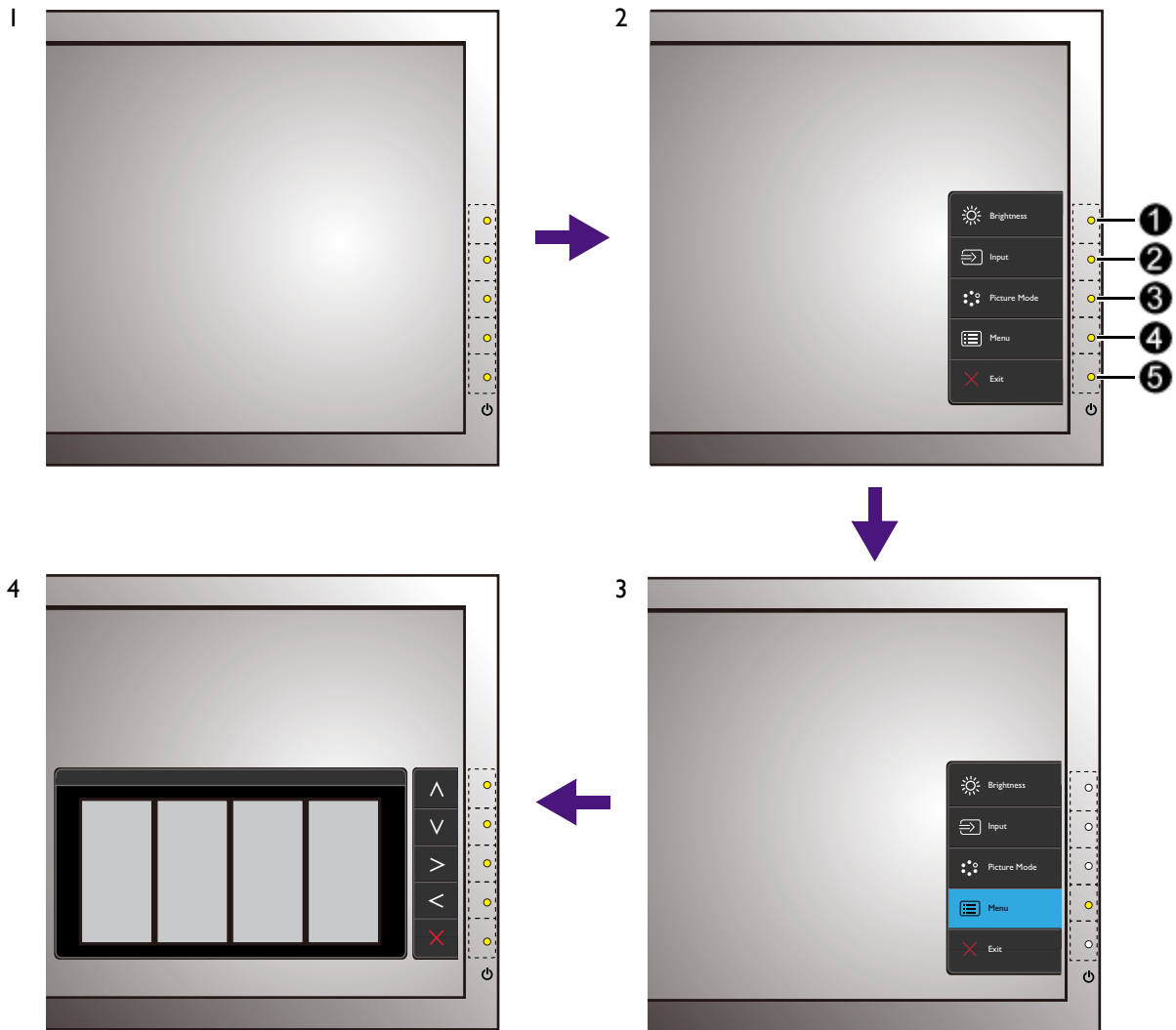
The control panel




No.	Name	Description
1.	Control keys	Accesses the functions or menu items displayed on the screen, right next to each key.
2.	Power key	Turns the power on or off.

Basic menu operation

All OSD (On Screen Display) menus can be accessed by the control keys. You can use the OSD menu to adjust all the settings on your monitor.



1. Press any of the control keys.
2. The hot key menu is displayed. The top three controls are custom keys and are designated for particular functions.
3. Select  (**Menu**) to access the main menu.
4. In the main menu, follow the icons next to the control keys to make adjustments or selection. See [Navigating the main menu on page 33](#) for details on the menu options.

No.	OSD in hot key menu	OSD icon in main menu	Function
①	Custom Key 1	^	<ul style="list-style-type: none"> • By default, the key is the hot key for Brightness. To change the default settings, see Customizing the hot keys on page 31. • For Up/Increase adjustment.

No.	OSD in hot key menu	OSD icon in main menu	Function
②	Custom Key 2	∨	<ul style="list-style-type: none"> • By default, the key is the hot key for Input. To change the default settings, see Customizing the hot keys on page 31. • For Down/Decrease adjustment.
③	Custom Key 3	> / ✓	<ul style="list-style-type: none"> • By default, the key is the hot key for Picture Mode. To change the default settings, see Customizing the hot keys on page 31. • Enters sub menus. • Selects menu items.
④	Menu	<	<ul style="list-style-type: none"> • Activates the main menu. • Returns to the previous menu.
⑤	Exit	×	Exits OSD menu.



- OSD = On Screen Display.
- The hot keys only operate while the main menu is not currently displaying. Hot key displays will disappear after a few seconds of no key activity.
- To unlock the OSD controls, press and hold any key for 10 seconds.

Controlling the display with Display Pilot

The **Display Pilot** software is provided as an alternative to control the display. Download and install from Support.BenQ.com (see [Product support on page 3](#)).

The main functions include:


- Control of the OSD menus.
- Setup of rotating the display with the monitor automatically (see [page 20](#)).



- To find out the supported operating systems, visit [BenQ website](#).


Customizing the hot keys

The top 3 control keys (also called custom keys) perform as hot keys to provide direct access to pre-defined functions. You can change the default setting and designate different functions for these keys.

1. Press any of the control keys to bring up the hot key menu, and press  (**Menu**) to access the main menu.
2. Go to **System**.
3. Select the custom key you want to change.
4. In the sub menu, select a function that can be accessed by this key. A pop-up message will appear, showing that the setup is complete.

Adjusting display mode

To display images of aspect ratio other than 16:9 and size other than the panel size of your purchased model, you can adjust the display mode on the monitor.

1. Press any of the control keys to bring up the hot key menu, and press  (**Menu**) to access the main menu.
2. Go to **Picture Advanced** and **Display Mode**.
3. Select an appropriate display mode. The setting will take effect immediately.

Choosing an appropriate picture mode

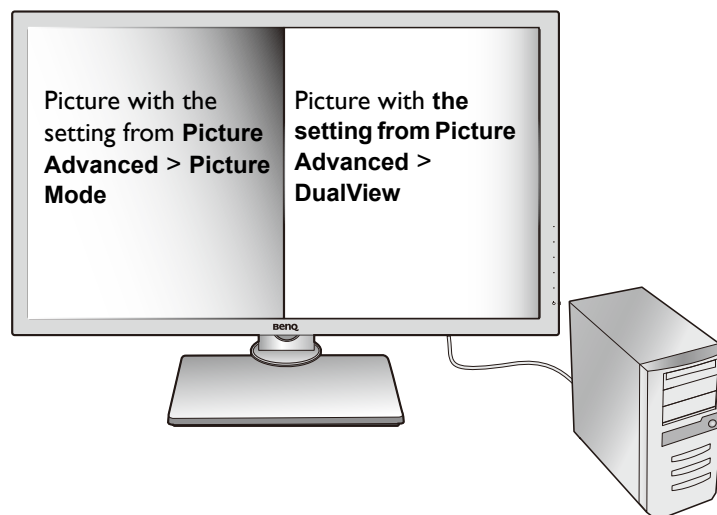
Your monitor provides various picture modes that are suitable for different types of images. See [Picture Mode on page 37](#) for all the available picture modes.

Go to **Picture Advanced** and **Picture Mode** for a desired picture mode.

Working with DualView


DualView helps improve your image editing efficiency by showing a image of two different picture modes side-by-side.

1. Select one picture mode from **Picture Advanced > Picture Mode**.
2. Go to **Picture Advanced > DualView > ON**. The screen is divided into two windows and the selected picture mode is applied to the left window.
3. A list of available picture modes for the right window is displayed. Select one to apply the setting.



Navigating the main menu

You can use the OSD (On Screen Display) menu to adjust all the settings on your monitor.

Press any of the control keys to bring up the hot key menu, and press  (**Menu**) to access the main menu. See [Basic menu operation on page 30](#) for details.

Available menu options may vary depending on the input sources, functions and settings. Menu options that are not available will become grayed out. And keys that are not available will be disabled and the corresponding OSD icons will disappear. For models without certain functions, their settings and related items will not appear on the menu.



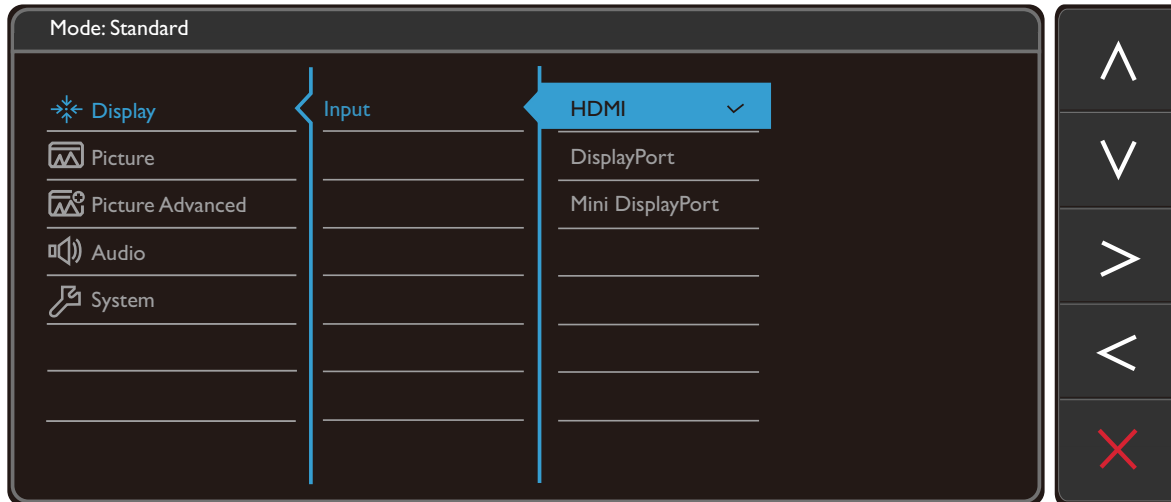
The OSD menu languages may differ from the product supplied to your region, see [Language on page 42](#) under **System** and **OSD Settings** for more details.












For more information on each menu, please refer to the following pages:

- [Display menu on page 34](#)
- [Picture menu on page 35](#)
- [Picture Advanced menu on page 37](#)
- [Audio menu on page 40](#)
- [System menu on page 41](#)

Display menu

Available menu options may vary depending on the input sources, functions and settings. Menu options that are not available will become grayed out. And keys that are not available will be disabled and the corresponding OSD icons will disappear. For models without certain functions, their settings and related items will not appear on the menu.



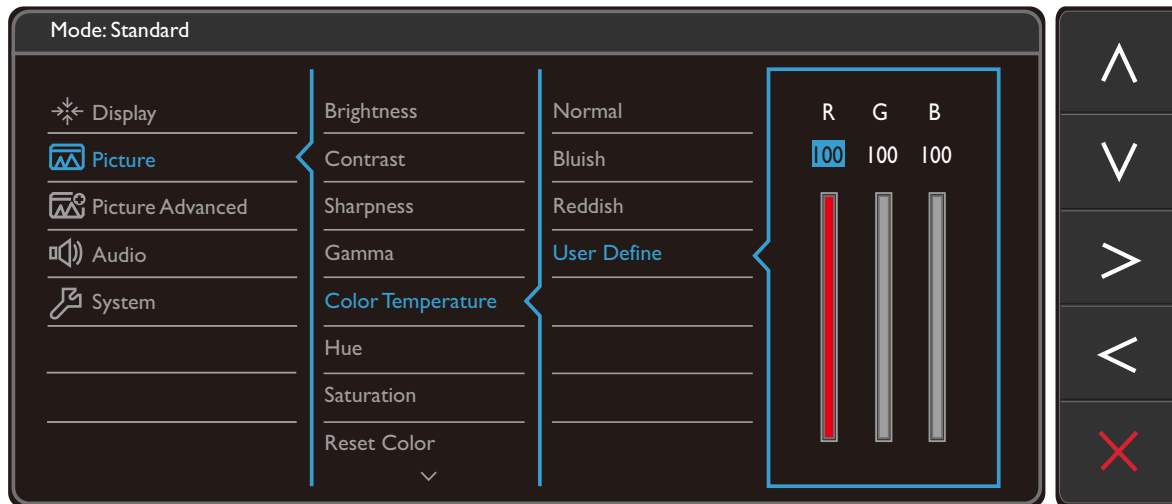
1. Select  (**Menu**) from the hot key menu.
2. Use  or  to select **Display**.
3. Select  to go to a sub menu, and then use  or  to select a menu item.
4. Use  or  to make adjustments, or use  to make selection.
5. To return to the previous menu, select .
6. To exit the menu, select .












For models with D-Sub inputs

Item	Function	Range
Input	Use this to change the input to that appropriate to your video cable connection type.	<ul style="list-style-type: none"> •HDMI •DisplayPort •Mini DisplayPort

Picture menu

Available menu options may vary depending on the input sources, functions and settings. Menu options that are not available will become grayed out. And keys that are not available will be disabled and the corresponding OSD icons will disappear. For models without certain functions, their settings and related items will not appear on the menu.



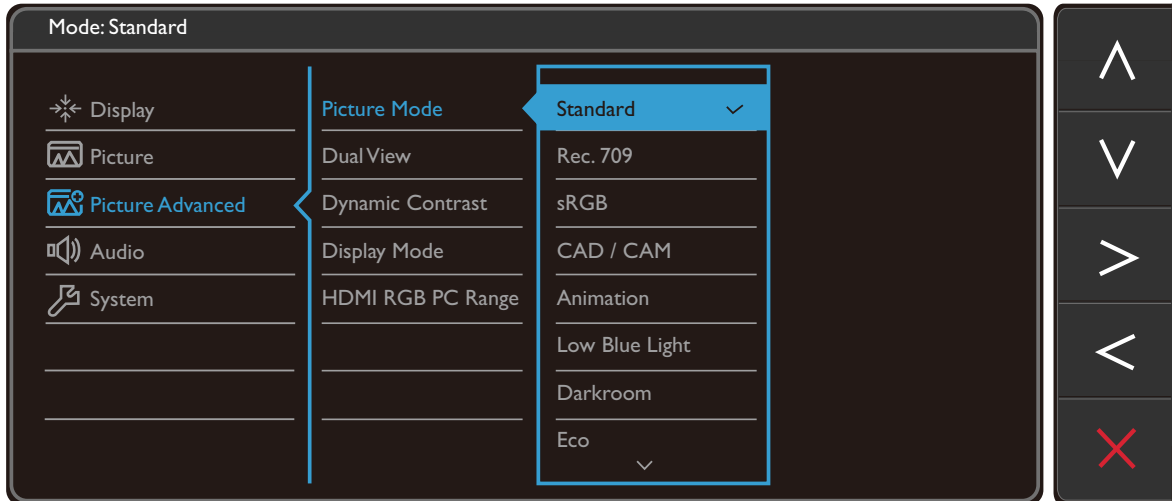
1. Select  (**Menu**) from the hot key menu.
2. Use  or  to select **Picture**.
3. Select  to go to a sub menu, and then use  or  to select a menu item.
4. Use  or  to make adjustments, or use  to make selection.
5. To return to the previous menu, select  .
6. To exit the menu, select  .












Item	Function	Range
Brightness	Adjusts the balance between light and dark shades.	0 to 100
Contrast	Adjusts the degree of difference between darkness and lightness.	0 to 100
Sharpness	Adjusts the clarity and visibility of the edges of the subjects in the image.	1 to 10
Gamma	Adjusts the tone luminance. The default value is 2.2 (the standard value for Windows).	<ul style="list-style-type: none"> • 1.8 • 2.0 • 2.2 • 2.4 • 2.6

Item	Function		Range
Color Temperature	Normal	Allows video and still photographs to be viewed with natural coloring. This is the factory default color.	
	Bluish	Applies a cool tint to the image and is factory pre-set to the PC industry standard white color.	
	Reddish	Applies a warm tint to the image and is factory pre-set to the news print standard white color.	
	User Define	The blend of the Red, Green and Blue primary colors can be altered to change the color tint of the image. Go to the succeeding R (red), G (green), and B (blue) menus to change the settings. Decreasing one or more of the colors will reduce their respective influence on the color tint of the image. (e.g. if you reduce the Blue level the image will gradually take on a yellowish tint. If you reduce Green, the image will become a magenta tint.)	<ul style="list-style-type: none"> • R (0~100) • G (0~100) • B (0~100)
Hue	Adjusts the degree of how we perceive colors.		0 ~ 100
Saturation	Adjusts the purity degree of colors.		0 ~ 100
Reset Color	Resets the custom color settings to the factory defaults.		<ul style="list-style-type: none"> • YES • NO
AMA	Improves the gray level response time of the LCD panel.		<ul style="list-style-type: none"> • OFF • High • Premium


Picture Advanced menu



Available menu options may vary depending on the input sources, functions and settings. Menu options that are not available will become grayed out. And keys that are not available will be disabled and the corresponding OSD icons will disappear. For models without certain functions, their settings and related items will not appear on the menu.



1. Select  (**Menu**) from the hot key menu.
2. Use  or  to select **Picture Advanced**.
3. Select  to go to a sub menu, and then use  or  to select a menu item.
4. Use  or  to make adjustments, or use  to make selection.
5. To return to the previous menu, select .
6. To exit the menu, select .

Item	Function		Range
Picture Mode	Select a picture mode that best suits the type of images shown on the screen.		
	Standard	For basic PC application.	
	Rec. 709	For better color matching representation with Standard Rec. 709.	
	sRGB	For better color matching representation with the peripheral devices, such as printers, digital cameras, etc.	
	CAD / CAM	Enhances the contrast if a CAD / CAM software is used.	
Animation	Enhances the contrast of the dark shades so you could work on the details easily when making an animation.	0 ~ 10	












Item	Function		Range
Low Blue Light	Decreases the blue light emitted from the display to reduce the risk of blue light exposure to your eyes.  The value for each Low Blue Light mode indicates how much blue light is decreased compared with the Standard mode.		
	Multimedia	For viewing multimedia files.	-30%
	Web Surfing	For web surfing.	-50%
	Office	For office works or office environment.	-60%
	Reading	For reading e-books or documents.	-70%
Darkroom	For image editing and viewing in a post-processing environment with a dim light. This mode enhances the sharpness and clarity of shades and shows more details.		
Eco	For saving electricity with low power consumption by providing minimum brightness for all running programs.		
User	Applies a combination of picture settings defined by users.		
DualView	Displays the preview of screen images under the selected mode from Picture Mode. The screen will be divided into two windows; the left window demonstrates images of the selected picture mode, while the right window presents the images under the specified mode.		<ul style="list-style-type: none"> • ON • OFF • sRGB • CAD / CAM • Animation • Low Blue Light • Darkroom • User Mode
Dynamic Contrast	The function is to automatically detect the distribution of an input visual signal, and then to create the optimal contrast.		0 to 5

Item	Function		Range
Display Mode	<p>This feature is provided to allow aspect ratios other than 16:9 to be displayed without geometric distortion.</p> <p> The options under Display Mode will be different depending on the input signal sources.</p> <p> Depending on your selection of Picture Mode, different Display Mode option is pre-set. Change the setting if needed.</p>		
	Full	Scales the input image to fill the screen. Ideal for 16:9 aspect images.	
	Aspect	The input image is displayed without geometric distortion filling as much of the display as possible.	
	1:1	Displays the input image in its native resolution without scaling.	
HDMI RGB PC Range	Determines the range of color scales. Select an option that matches the RGB range setting on the connected HDMI device.		<ul style="list-style-type: none"> • Auto Detect • RGB (0 ~ 255) • RGB (16 ~ 235)

Audio menu

Available menu options may vary depending on the input sources, functions and settings. Menu options that are not available will become grayed out. And keys that are not available will be disabled and the corresponding OSD icons will disappear. For models without certain functions, their settings and related items will not appear on the menu.

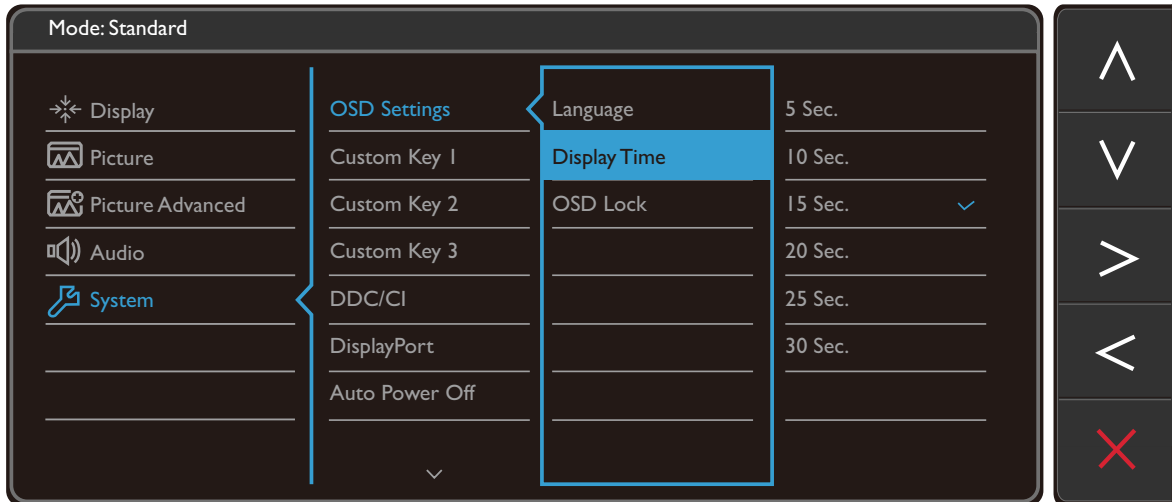













1. Select  (**Menu**) from the hot key menu.
2. Use  or  to select **Audio**.
3. Select  to go to a sub menu, and then use  or  to select a menu item.
4. Use  or  to make adjustments, or use  to make selection.
5. To return to the previous menu, select .
6. To exit the menu, select .



Item	Function	Range
Volume	Adjusts the audio volume.	0 ~ 100
Mute	Mutes the audio input.	• ON • OFF


System menu

Available menu options may vary depending on the input sources, functions and settings. Menu options that are not available will become grayed out. And keys that are not available will be disabled and the corresponding OSD icons will disappear. For models without certain functions, their settings and related items will not appear on the menu.











1. Select  (**Menu**) from the hot key menu.
2. Use  or  to select **System**.
3. Select  to go to a sub menu, and then use  or  to select a menu item.
4. Use  or  to make adjustments, or use  to make selection.
5. To return to the previous menu, select .
6. To exit the menu, select .

Item	Function		Range
OSD Settings	Language	<p>Sets the OSD menu language.</p>  <p>The language options displayed on your OSD may differ from those shown on the right, depending on the product supplied in your region.</p>	<ul style="list-style-type: none"> • English • Français • Deutsch • Italiano • Español • Polski • Český • Magyar • SiCG/BIH/CRO • Română • Nederlands • Русский • Svenska • Português • 日本語 • 한국어 • 繁體中文 • 简体中文 • العربية
	Display Time	Adjusts the display time of the OSD menu.	<ul style="list-style-type: none"> • 5 sec. • 10 sec. • 15 sec. • 20 sec. • 25 sec. • 30 sec.
	OSD Lock	<p>Prevents all the monitor settings from being accidentally changed. When this function is activated, the OSD controls and hotkey operations will be disabled.</p>  <p>To unlock the OSD controls, press and hold any key for 10 seconds.</p>	
Custom Key 1	Sets the function to be accessed by custom key 1.		<ul style="list-style-type: none"> • Brightness • Contrast • Input • Picture Mode • Display Mode • Volume • Mute
Custom Key 2	Sets the function to be accessed by custom key 2.		
Custom Key 3	Sets the function to be accessed by custom key 3.		

















Item	Function	Range
DDC/CI	<p>Allows the monitor settings to be set through the software on the PC.</p>  <p>DDC/CI, short for Display Data Channel/Command Interface, which was developed by Video Electronics Standards Association (VESA). DDC/CI capability allows monitor controls to be sent via the software for remote diagnostics.</p>	<ul style="list-style-type: none"> • ON • OFF
DisplayPort	Selects an appropriate DP standard for data transmission.	<ul style="list-style-type: none"> • 1.1 • 1.2
Auto Power Off	Sets the time to power off the monitor automatically in power saving mode.	<ul style="list-style-type: none"> • OFF • 10min. • 20min. • 30min.
Resolution Notice	Sets whether to display the resolution notice of the recommended resolution when a new input source is detected by the monitor.	<ul style="list-style-type: none"> • ON • OFF
Information	Displays the current monitor property settings.	<ul style="list-style-type: none"> • Input • Current Resolution • Optimum Resolution (best with the monitor)
Reset All	Resets all mode, color and geometry settings to the factory default values.	<ul style="list-style-type: none"> • YES • NO


Troubleshooting


Frequently asked questions (FAQ)


-  The image is blurred.
-  Download **Resolution file** from the website (see [Product support on page 3](#)). Refer to "**Adjusting the Screen Resolution**". And then select the correct resolution, refresh rate and make adjustments based on these instructions.
-  Does the blurring only occur at resolutions lower than the native (maximum) resolution?
-  Download **Resolution file** from the website (see [Product support on page 3](#)). Refer to "**Adjusting the Screen Resolution**". Select the native resolution.
-  Pixel errors can be seen.
- One of several pixels is permanently black, one or more pixels are permanently white, one or more pixels are permanently red, green, blue or another color.
- 
 - Clean the LCD screen.
 - Cycle power on-off.
 - These are pixels that are permanently on or off and is a natural defect that occurs in LCD technology.
-  The image has a faulty coloration.
-  It has a yellow, blue or pink appearance.
- Go to **Picture** and **Reset Color**, and then choose **YES** to reset the color settings to the factory defaults.


If the image is still not correct and the OSD also has faulty coloration, this means one of the three primary colors is missing in the signal input. Now check the signal cable connectors. If any pin is bent or broken off, please contact your dealer to get necessary support.

-  The LED indicator is green or orange.
-  • If the LED lights up in solid green, the monitor is powered on.
 -  • If the LED is illuminated in green and there is a message **Out of Range** on the screen, this means you are using a display mode that this monitor does not support, please change the setting to one of the supported mode. Download **Resolution file** from the website (see [Product support on page 3](#)). Refer to "**Adjusting the Screen Resolution**". And then select the correct resolution, refresh rate and make adjustments based on these instructions.
 -  • If the LED is illuminated in orange, the power management mode is active. Press any button on the computer keyboard or move the mouse. If that does not help, check the signal cable connectors. If any pin is bent or broken off, please contact your dealer to get necessary support.
 -  • If the LED is off, check the power supply mains socket, the external power supply and the mains switch.
-  Faint shadow from the static image displayed is visible on the screen.
-  • Activate the power management function to let your computer and monitor go into a low power "sleep" mode when not actively in use.
 -  • Use a screensaver to prevent the occurrence of image retention.
-  The image is distorted, flashes or flickers.
-  Download **Resolution file** from the website (see [Product support on page 3](#)). Refer to "**Adjusting the Screen Resolution**". And then select the correct resolution, refresh rate and make adjustments based on these instructions.
-  You are running the monitor at its native resolution, but the image is still distorted.
-  Images from different input sources may appear distorted or stretched on the monitor running at its native resolution. To have the optimal display performance of each type of input sources, you can use the **Display Mode** function to set a proper aspect ratio for the input sources. See [Display Mode on page 39](#) for details.
-  The image is displaced in one direction.
-  Download **Resolution file** from the website (see [Product support on page 3](#)). Refer to "**Adjusting the Screen Resolution**". And then select the correct resolution, refresh rate and make adjustments based on these instructions.
-  The OSD controls are inaccessible.
-  To unlock the OSD controls when it is preset to be locked, press and hold any key for 10 seconds.

 No sound can be heard from the connected external speakers.

-  • Remove your headphone (if the headphone is connected to the monitor).
- Check whether the headphone jack is properly connected.
- If the external speakers are USB-powered, check whether the USB connection is OK.
- Increase the volume (volume may be muted or too low) on the external speakers.

 No sound can be heard from the built-in speakers:

-  • Check whether Line In is properly connected.
- Increase the volume (volume may be muted or too low).
- Remove your headphone and/or external speakers. (If they are connected to the monitor, the built-in speakers are automatically muted.)

Need more help?

If your problems remain after checking this manual, please contact your place of purchase or visit the local website from [Support.BenQ.com](https://support.benq.com) for more support and local customer service.