

User's Guide

EH-TW5800

EH-TW5700

Home Projector

Using Each Guide

The guides for this projector are organized as shown below.

Safety Instructions

Contains information on using the projector safely, as well as a support and service guide, troubleshooting check lists, and so on. Make sure you read this guide before using the projector.



User's Guide (this guide)

Contains information on setting up and basic operations before using the projector, using the Configuration menu, and handling problems and performing routine maintenance.



Quick Start Guide

Contains information on the procedures for setting up the projector. Read this first.

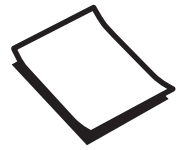

Notations Used in This Guide

Safety Indications

The documentation and the projector use graphical symbols to show how to use the projector safely and avoid injury to persons or property. The following shows the symbols and their meanings. Make sure that you understand these caution symbols before reading this guide.

Warning

This symbol indicates information that, if ignored, could possibly result in personal injury or even death due to incorrect handling.



Caution

This symbol indicates information that, if ignored, could possibly result in personal injury or physical damage due to incorrect handling.

General Information Indications

Attention

Indicates procedures which may result in damage or malfunctions to occur.

	Indicates additional information and points which may be useful to know regarding a topic.
	Indicates a page where detailed information regarding a topic can be found.
Menu Name	Indicates Configuration menu items. Example: Image - Color Mode
[Hardware Names]	Indicates the buttons on the remote control or the control panel. Example: [Menu] button

About the Use of "This Product" or "This Projector"

As well as the main projector unit, supplied items or optional extras may be referred to using the phrase "this product" or "this projector".

Organization of the Guide and Notations in the Guide

Using Each Guide	1
Notations Used in This Guide	2
Safety Indications	2
General Information Indications	2
About the Use of "This Product" or "This Projector"	2

Introduction

Projector Features	6
Equipped with High-quality Image Resolution Optimized for Full HD	6
New Gaming Features that will Change the Way You Enjoy Games	6
Genuine Living Room Theater Experience	6

Part Names and Functions	7
Front/Top	7
Control Panel	8
Rear	9
Base	10
Remote Control	11

Preparing

Installing	14
Projected Image and Position of Projector	14
Installing in parallel with the screen	14
Installing the projector horizontally by adjusting the height of either side	14
Various Setting Methods	15
Placing on a table and projecting	16
Suspending from the ceiling and projecting	16
Projection Distance and Lens Shift Maximum Values	17

Connecting a Device	20
Connecting Video Equipment	20
Connecting a Computer	20
Connecting External Equipment	20
Connecting Bluetooth® devices	20
Connecting external speakers	22

Preparing the Remote Control	23
Installing the Remote Control Batteries	23
Remote Control Operating Range	24
Operating range (left to right)	24
Operating range (top to bottom)	24

Basic Operations

Projecting Images	25
Turning On the Projector	25
If the target image is not projected	26
Turning Off	26

Adjusting the Projected Image	27
Adjusting the Focus	27
Adjusting the Projection Size (Adjust Zoom)	27
Adjust the Height of the Image	27
Adjusting the Projector's Tilt	28
Adjusting the Position of the Image (Lens Shift) (EH-TW5800 Only)	28
Correcting Keystone Distortion	29
Correct automatically (Auto V-Keystone)	29
Correct manually (H-Keystone Adjuster)	29
Correct manually (H/V-Keystone)	29
Correct manually (Quick Corner)	30
Adjusting the Volume	32
Hiding the Image and Muting the Audio Temporarily (A/V Mute)	32

Adjusting the Image

Adjusting the Image	33
Selecting the Projection Quality (Color Mode)	33
Switching the Screen Between Full and Zoom (Asspect)	33
Adjusting the Sharpness	34
Adjusting Image Resolution (Image Enhancement)	35
Setting Auto Iris	35
Setting Frame Interpolation	36
Setting the Image Processing Speed	36
Adjusting the Color	38

Adjusting the Color Temp.	38
Adjusting the RGB (Offset and Gain)	38
Adjusting Hue, Saturation, and Brightness	39
Adjusting the Gamma	40
Select and adjust the correction value	40
Adjust using the gamma adjustment graph	41
Viewing the Image at the Saved Image Quality (Memory Function)	42
Saving a Memory	42
Loading, Deleting, and Renaming a Memory	43

Useful Functions

Enjoying 3D Images	44
Preparing to View 3D Images	44
If the 3D image cannot be viewed	44
Using 3D Glasses	45
Notifications Regarding Viewing 3D Images	45
Using the HDMI Link Function	47
HDMI Link Function	47
HDMI Link Settings	47
Connecting	48

Configuration Menu

Configuration Menu Functions	49
Configuration Menu Operations	49
Configuration Menu Table	50
Image menu	50
Signal menu	51
Settings menu	52
Extended menu	54
Info menu	55
Reset menu	56

Troubleshooting

Problem Solving	57
Reading the Indicators	57
Indicator status during an error/warning	57
Indicator status during normal operation	59

When the Indicators Provide No Help	60
Check the problem	60
Problems relating to images	61
Noise problems	64
Problems when projection starts	64
Problems with the remote control	65
Problems with the control panel	65
Problems with 3D	65
Problems with HDMI	66
Bluetooth device problems	67
Problems with a streaming media player	67

Maintenance

Maintenance	69
Cleaning the Parts	69
Cleaning the air filter	69
Cleaning the main unit	70
Cleaning the lens	71
Replacement Periods for Consumables	71
Air filter replacement period	71
Lamp replacement period	71
Replacing Consumables	72
Replacing the air filter	72
Replacing the lamp	72
Resetting lamp hours	74
Disconnecting a Streaming Media Player	76

Appendix

Optional Accessories and Consumables	77
Optional Items	77
Consumables	77
Supported Resolutions	78
PC	78
SD	78
HD	78
3D	79
Specifications	81
EH-TW5800/EH-TW5700	81
Appearance	83

List of Safety Symbols	84
Glossary	86
General Notes	87
Warning Labels	88
Disposal	88
General Notice	89



Projector Features

Equipped with High-quality Image Resolution Optimized for Full HD

- You can play fast moving images smoothly using frame interpolation. 🖱️ [p.36](#)
- You can project clear images that are rich in texture by using the noise reduction and detail enhancement features. 🖱️ [p.35](#)

New Gaming Features that will Change the Way You Enjoy Games

- With 21:9 input support, you can display game content to the full horizontal width of your screen.
- You can set the image processing speed and improve the response time for fast-moving images. 🖱️ [p.36](#)
- The Dark Gamma Uplift feature allows you to adjust dark areas for greater visibility. 🖱️ [p.40](#)

Genuine Living Room Theater Experience

- The built-in Android TV™ allows you to easily start viewing content by connecting to the Internet.
- Speaker enclosures allow you to enjoy realistic audio.

Part Names and Functions

Front/Top

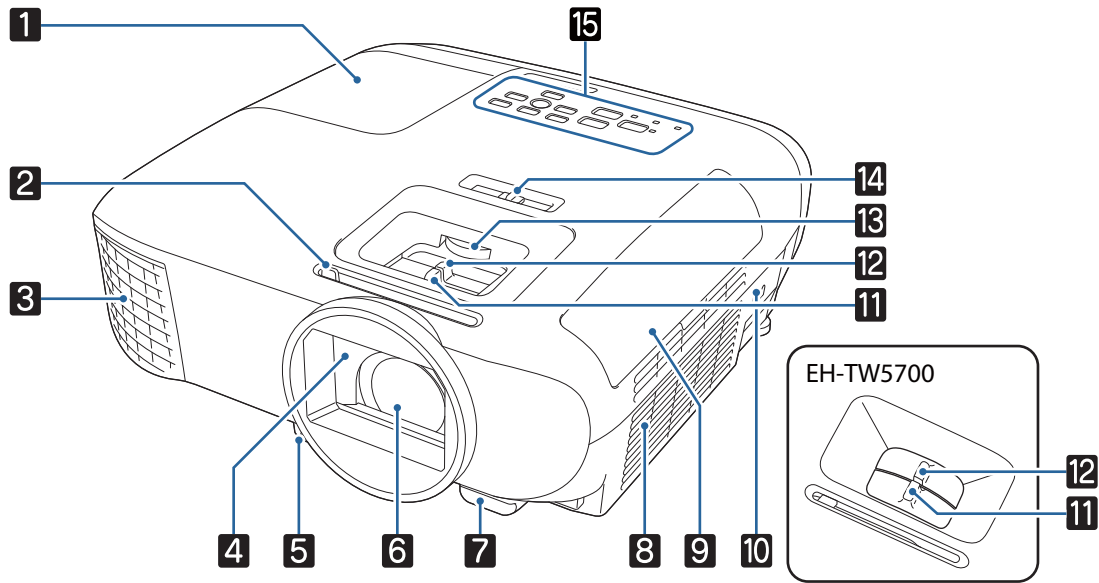

Name		Function
1	Lamp cover	Open when replacing the projector's lamp. p.72
2	A/V mute slide lever	Slide the knob to open and close the lens cover. By closing during projection you can hide the image and audio. p.32
3	Air exhaust vent	Exhaust vent for air used to cool the projector internally. <div style="border: 1px solid black; padding: 5px; margin-bottom: 5px;"> <p> Warning</p> <p>Do not look into the air exhaust vent. If the lamp explodes, scattered small shards of glass and released gas may cause an injury. If any glass gets into your eyes or mouth, contact your local physicians immediately.</p> </div> <div style="border: 1px solid black; padding: 5px;"> <p> Caution</p> <p>While projecting, do not put your face or hands near the air exhaust vent, and do not place objects that may become warped or damaged by heat near the vent. Hot air from the air exhaust vent could cause burns, warping, or accidents to occur.</p> </div>
4	Lens cover	Close when not using the projector to protect the lens from being scratched or soiled. p.26
5	Foot release lever	Press the foot release lever to extend and retract the front adjustable foot. p.27
6	Lens	Images are projected from here.
7	Remote receiver	Receives signals from the remote control. p.24
8	Air intake vent	Intake vent for air used to cool the projector internally.

Name		Function
9	Air filter cover	When replacing the air filter, open this cover and remove the air filter. p.72
10	Security slot ()	The security slot compatible with the MicroSaver security system manufactured by Kensington. For more details, visit the homepage of Kensington at http://www.kensington.com/ .
11	Focus adjuster (EH-TW5800) Focus ring (EH-TW5700)	Adjusts the image focus. p.27
12	Zoom adjuster (EH-TW5800) Zoom ring (EH-TW5700)	Adjusts the image size. p.27
13	Lens shift dial (EH-TW5800 only)	Moves the position of the image vertically. p.28
14	Horizontal keystone adjuster	Performs horizontal keystone correction. p.29
15	Control panel	Operates the projector. p.8

Control Panel

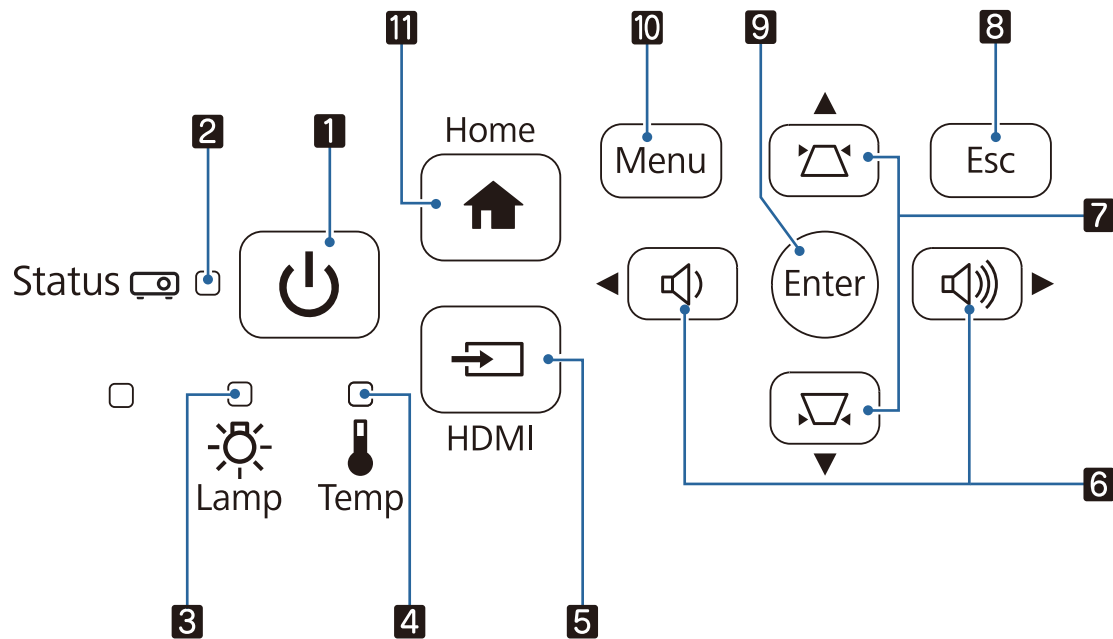

Name		Function
1	Standby button (Standby indicator)	Turns the projector on or off. p.25 Shows the projector's status through a combination of other indicators lit and flashing. p.59
2	Status indicator	Flashes blue to indicate the projector is warming up or cooling down. Shows the projector's status through a combination of other indicators lit and flashing. p.57
3	Lamp indicator	Flashes orange when it is time to replace the lamp. Shows the projector's errors through a combination of other indicators lit and flashing. p.57

Name	Function
4 Temperature indicator	Flashes orange if the internal temperature is too high. Shows the projector's errors through a combination of other indicators lit and flashing. 🖱️ p.57
5 [HDMI] button	Changes to the image from the HDMI port. 🖱️ p.26
6 Volume (Left/Right) buttons	<ul style="list-style-type: none"> Adjusts the volume. 🖱️ p.32 Selects menu items or adjustment values while displaying the projector's menu. Performs horizontal keystone correction when the Keystone screen is displayed. 🖱️ p.29
7 Keystone (Up/Down) buttons	<ul style="list-style-type: none"> Adjusts keystone distortion in projected images. 🖱️ p.29 Selects menu items or adjustment values while displaying the projector's menu.
8 [Esc] button	Returns to the previous menu level when a menu is displayed. 🖱️ p.49
9 [Enter] button	Selects functions and settings when a menu is displayed. 🖱️ p.49
10 [Menu] button	Displays and closes the Configuration menu. On the Configuration menu, you can make adjustments and settings for Signal, Image, Input Signal, and so on. 🖱️ p.49
11 [Home] button	Switches to the image from Android TV™.



When the Illumination function is set to **Off**, all indicators are off under normal projection conditions. 🖱️ **Extended - Operation - Illumination** [p.54](#)

Rear

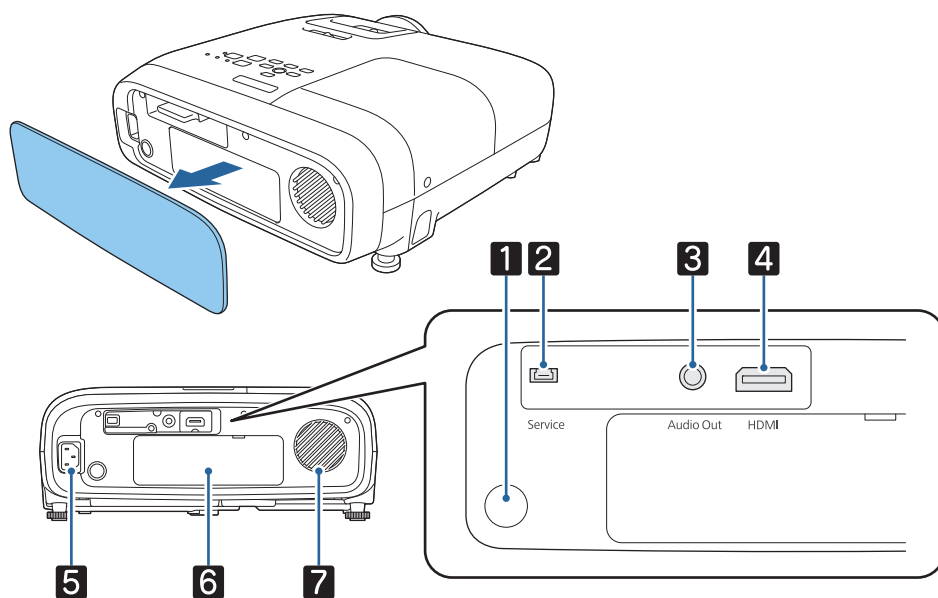



Name	Function
1 Remote receiver	Receives signals from the remote control. 🖱️ p.24
2 Service port	Service port. This is not normally used.
3 Audio Out port	Outputs audio during playback to external speakers. 🖱️ p.22
4 HDMI port	Connects HDMI compatible video equipment and computers. 🖱️ p.20
5 Power inlet	Connects a power cord. 🖱️ p.25

Name		Function
6	Storage space cover	Remove the cover when connecting or removing a streaming media player.  p.76
7	Speaker	The projector's built-in speaker. Outputs audio.

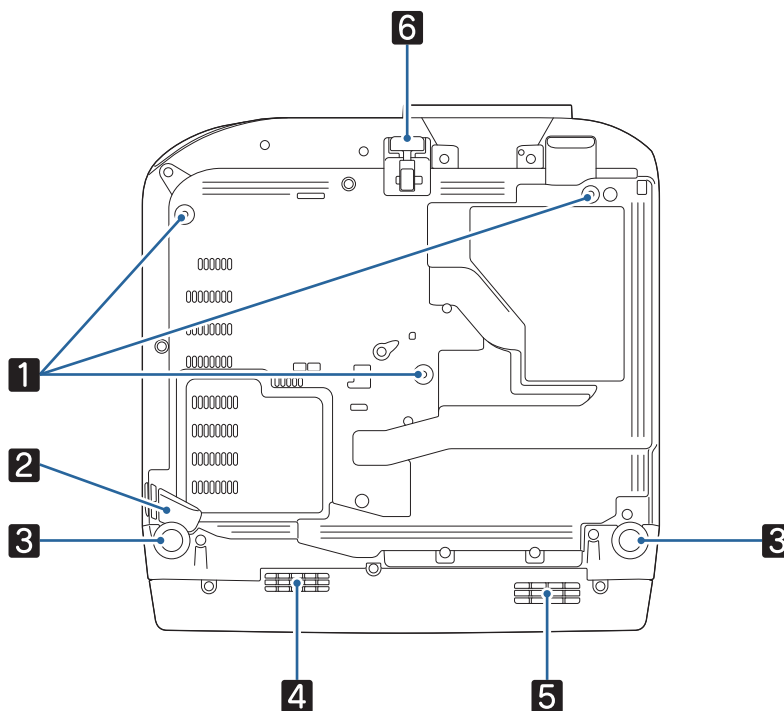
Base



Name		Function
1	Ceiling mount fixing points (three points)	Attach the optional ceiling mount here when suspending the projector from a ceiling.  p.77
2	Security cable section	Secure a commercially available anti-theft wire lock through this section. You can also attach a safety wire to prevent the projector from falling.
3	Rear feet	When setting up on a surface such as a table, extend the feet to adjust horizontal tilt.  p.28
4	Air exhaust vent	Air exhaust vent to cool the streaming media player.
5	Air intake vent	Takes in air to cool the streaming media player.
6	Front adjustable foot	When setting up on a surface such as a table, extend the foot to adjust the height of the image.  p.28

Remote Control

Projector remote control

Remote control for operating the projector and Android TV™.

Unless stated otherwise, this guide describes operations for the projector remote control.

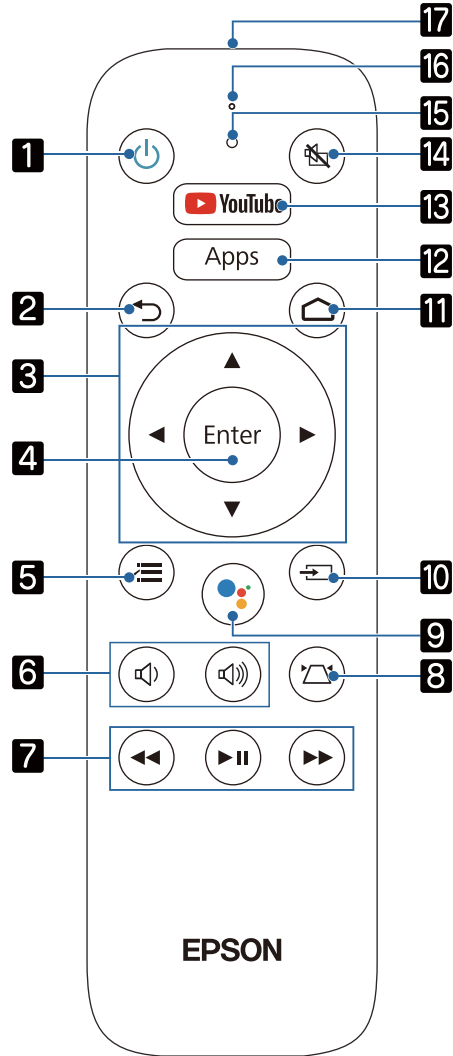

Name		Function
1	Standby button	Turns the projector on or off. p.25
2	Esc button	Closes the current function. Press when a menu is displayed to return to the previous menu level. p.49
3	Up/Down/Left/Right buttons	Selects menu items and adjustment values. p.49
4	[Enter] button	When a menu is displayed, it confirms the current item and moves to the next level. p.49
5	Menu button	Displays and closes the Configuration menu. On the Configuration menu, you can make adjustments and settings for Signal, Image, and so on. p.49
6	Volume buttons	Adjusts the volume. p.32
7	Playback control buttons	Operates Android TV™ and video devices compliant with the HDMI CEC standard. p.47

	Name	Function
8	Keystone button	Corrects distortion in the image. p.29
9	Mic button	Allows you to operate Android TV™ using voice commands. When you press this button, the microphone on the remote control starts listening for voice commands.
10	Source button	Changes to the image from each input port.
11	Home button	Displays or closes the Android TV™ home screen.
12	Apps button	Displays a list of apps for Android TV™.
13	YouTube button	Opens the YouTube app.
14	A/V Mute button	Temporarily hides or shows the image and audio. p.32
15	Indicator	Turns on while operating the remote control.
16	Microphone section	This detects voice commands when you press the Mic button.
17	Remote control light emitting area	Outputs remote control signals.

Remote control for Android TV™

Remote control for operating Android TV™.

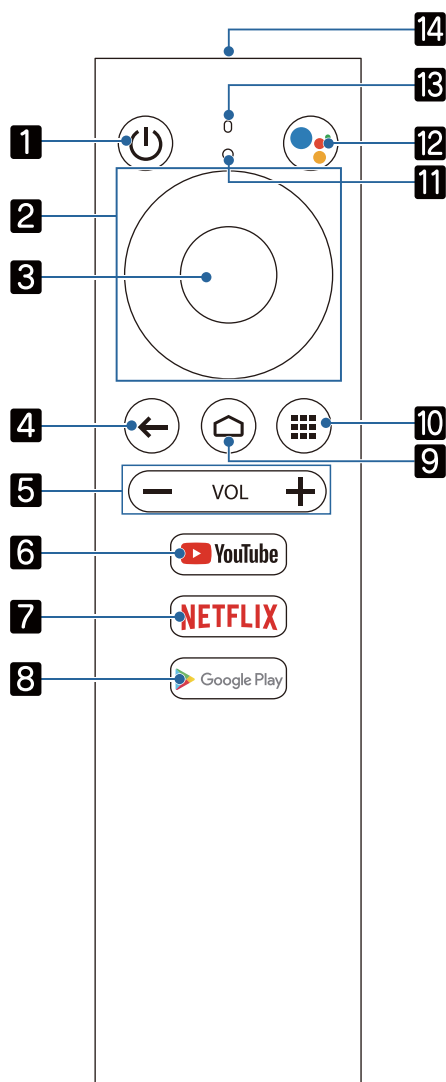

Name		Function
1	Standby button	Turns Android TV™ on or off.
2	Up/Down/Left/Right buttons	Selects the Android TV™ menu items.
3	Enter button	Confirms the current Android TV™ menu item and moves to the next level.
4	Esc button	Press while Android TV™ is displayed to return to the previous menu level.
5	Volume buttons	Adjusts the volume for Android TV™.
6	YouTube button	Opens the YouTube app.
7	Netflix button	Opens the Netflix app.
8	Google Play button	Connects to Google Play.
9	Home button	Displays the Android TV™ home screen.
10	Apps button	Displays a list of apps for Android TV™.
11	Indicator	Turns on while operating the remote control.
12	Mic button	Allows you to operate Android TV™ using voice commands. When you press this button, the microphone on the remote control starts listening for voice commands.
13	Microphone section	This detects voice commands when you press the Mic button.
14	Remote control light emitting area	Outputs remote control signals.

Installing

Projected Image and Position of Projector

Install the projector as follows.

■ Installing in parallel with the screen

If the projector is installed at an angle to the screen, keystone distortion occurs in the projected image. Adjust the projector's position so that it is installed in parallel with the screen.

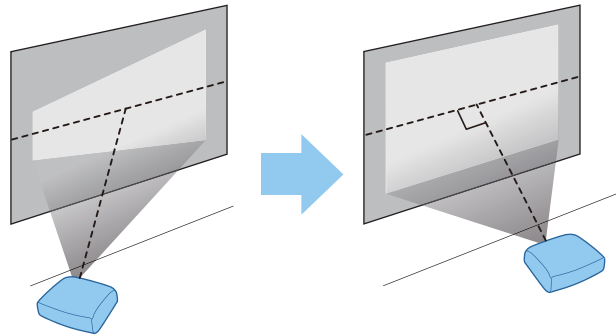

If the projector cannot be installed in parallel, use one of the following methods to adjust the projected image.

- Correct distortion in the image using the horizontal keystone adjuster or H/V-Keystone [p.29](#)
- Adjust the position of the projected image using lens shift (EH-TW5800 only) [p.28](#)

■ Installing the projector horizontally by adjusting the height of either side

If the projector is tilted, the projected image is also tilted.

Install the projector horizontally so that both sides are at the same height.

If the projector cannot be installed horizontally, you can adjust the projector's tilt with the rear feet. [p.28](#)

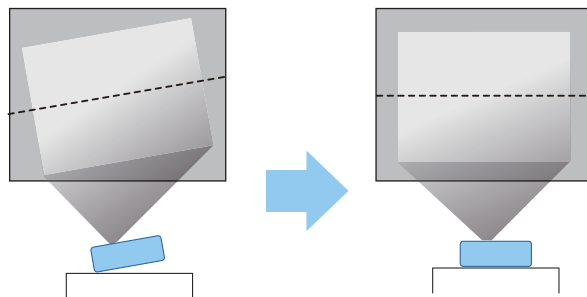

Various Setting Methods

Warning

- A special method of installation is required when suspending the projector from a ceiling (ceiling mount). If it is not installed correctly, it could fall, causing an accident and injury.
- Failure to install the ceiling mount and projector may cause the projector to fall. Be sure to use the specific Epson mount that supports this projector, and secure it to all of the projector's ceiling mount fixing points. Also, make sure you secure the projector and the mount using wire and so on that is strong enough to hold their weight.
- Do not apply adhesives, oils, lubricants, detergents, solvents, chemicals, and so on to the projector case or the mount. Otherwise, the projector case may deteriorate or be damaged causing the projector to fall from the mount.
- Do not set up the projector in locations exposed to humidity or dust, or in locations exposed to oil smoke or steam such as on a kitchen counter, in the kitchen, or near a humidifier. Doing so could cause fire or electric shock. In addition, the oil content could cause the projector's outer case to deteriorate and could cause the projector to fall off from the ceiling where it is suspended.

Examples of environments that could cause the projector to fall due to case deterioration/damage

- Locations subject to oily smoke, such as factories, restaurant kitchens, or home kitchens
- Locations containing volatile solvents or chemicals, such as factories or laboratories
- Locations where oil, detergents, chemicals, and so on could adhere to the projector such as factories, restaurant kitchens, or home kitchens
- Locations in which aroma oils are often used, such as relaxation rooms
- Locations near devices that produce excessive smoke, airborne oil particles, or foam at events
- Do not install in locations where salt damage could occur, or in locations subject to corrosive gas such as sulphuric gas from hot springs. Otherwise, corrosion could cause the projector to fall. It could also cause the projector to malfunction.
- Do not install it on an unstable shelf or in a place out of load range. Otherwise, it could fall or topple causing an accident and injury.
- When installing the projector in a high position such as on a shelf, take measures against falling by using wires or belts to ensure safety in an emergency such as an earthquake, and to prevent accidents. If it is not installed correctly, it could fall causing an accident and injury.
- Do not block the air intake vent and air exhaust vent of the projector. Blocking its air intake vent and air exhaust vent may trap heat inside causing fire.
- Do not use or store the projector in dusty or dirty locations. Doing so could cause the quality of the projected image to deteriorate, or the air filter to become clogged with dust which can cause malfunctions or a fire to occur.

Attention

- Do not project under the following conditions. Doing so could cause a malfunction or accident to occur.
 - Do not project by standing the projector vertically
 - Do not project from above or below
 - Do not project by tilting to the left or right
- Clean the air filter once every three months. Clean it more often if the environment is particularly dusty.

 [p.69](#)

■ Placing on a table and projecting

You can install the projector on a table in your living room or on a low shelf to project images.

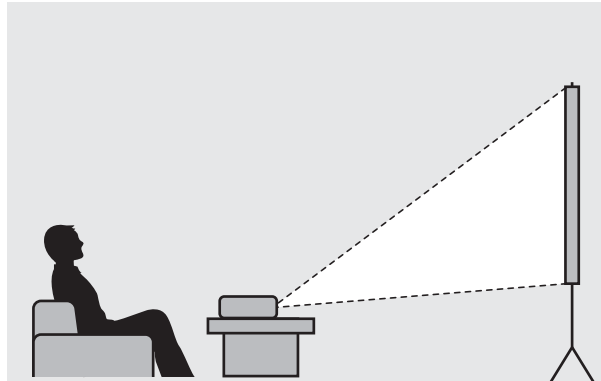

■ Suspending from the ceiling and projecting

You can suspend the projector from the ceiling with the optional ceiling mount to project images.

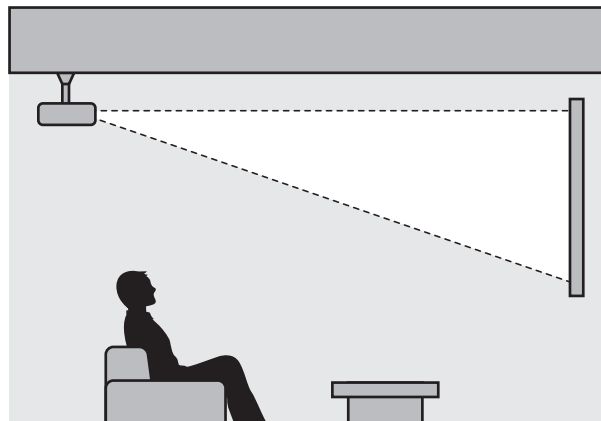

When suspending from the ceiling and projecting, set **Projection** to **Front/Ceiling** or **Rear/Ceiling**. ➡ **Extended - Projection** [p.54](#)

Projection Distance and Lens Shift Maximum Values

The size of the projection increases as the projector is moved away from the screen.

Use the table below to setup the projector at the optimum position from the screen. The values given here are for your reference only.

The maximum lens shift adjustment values are shown in the following table.



The projected image becomes smaller after correcting distortion. Increase the projection distance to fit the projected image to the screen size.

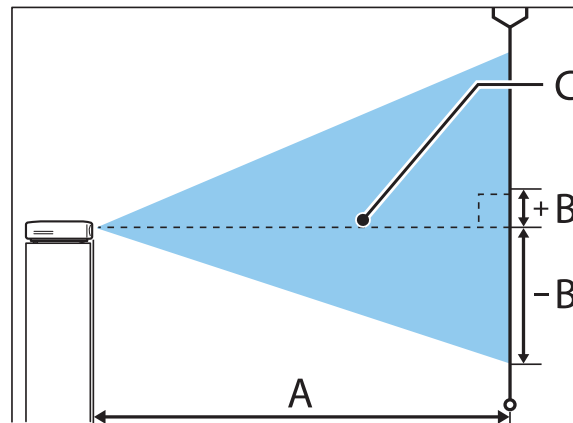

A : Projection distance from the projector to the screen

B : Height from the center of the lens to the bottom edge of the projected image

C : Center of the lens

EH-TW5800

Unit: cm

16:9 Screen Size		Projection distance (A)		Lens shift maximum values (B)	
		Minimum (Wide)	Maximum (Tele)	Highest	Lowest
60"	133 x 75	176	286	-4	+7
80"	177 x 100	235	382	-5	+10
100"	221 x 125	295	478	-6	+12
120"	266 x 149	354	575	-7	+15
150"	332 x 187	443	719	-9	+19
200"	443 x 249	591	959	-12	+25
250"	553 x 311	740	1200	-16	+31
300"	664 x 374	888	1441	-19	+37

EH-TW5700

Unit: cm

16:9 Screen Size		A		B*
		Minimum (Wide)	Maximum (Tele)	
60"	133 x 75	162	195	-5
80"	177 x 100	217	261	-7
100"	221 x 125	272	327	-8
150"	332 x 187	410	492	-12
200"	443 x 249	547	658	-16
250"	553 x 311	685	823	-20
332"	735 x 413	911	1094	-27

* Lens shift is not supported.

Installation example (with 16:9 screen size, 100", and the EH-TW5800)

Side view

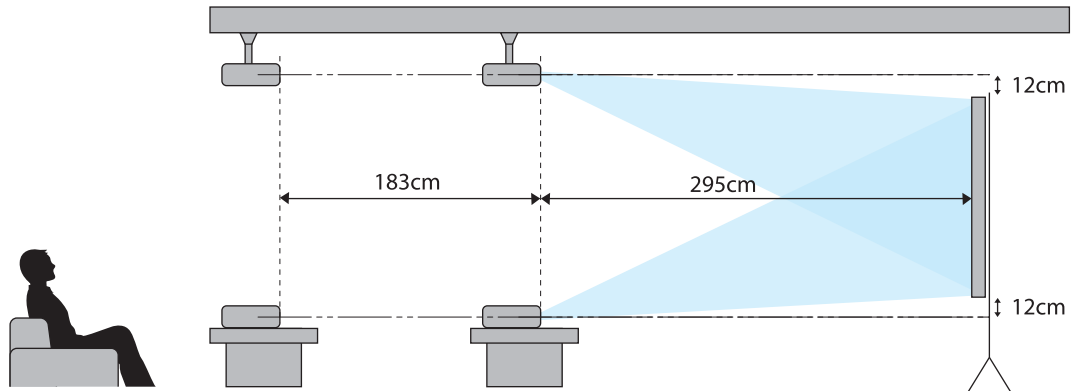

Overhead view

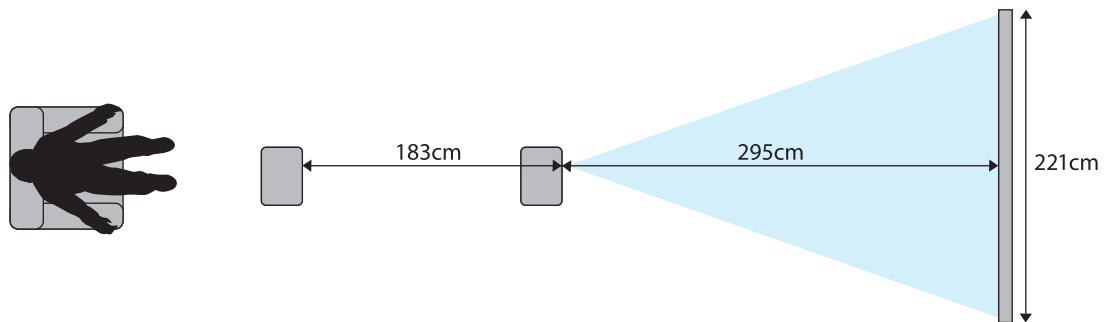

Connecting a Device

Attention

- Make cable connections before connecting to a power outlet.
- Check the shape of the cable's connector and the shape of the port, and then connect. If you force a connector of a different shape into the port, it could cause damage and a malfunction to occur.

Connecting Video Equipment

To project images from DVD/Blu-ray players, connect to the projector using an HDMI cable (commercially available).

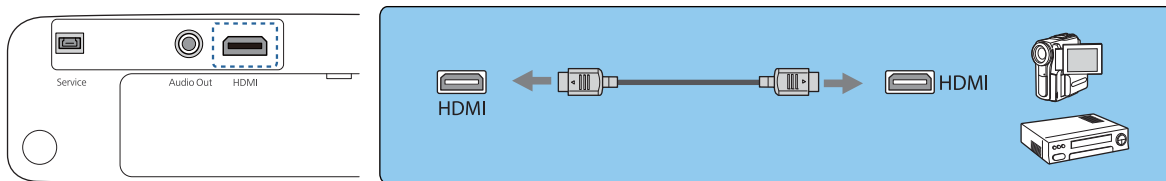

You can also connect your AV system to enjoy the audio from connected equipment.

Connecting a Computer

To project images from a computer, connect to the projector using an HDMI cable (commercially available).

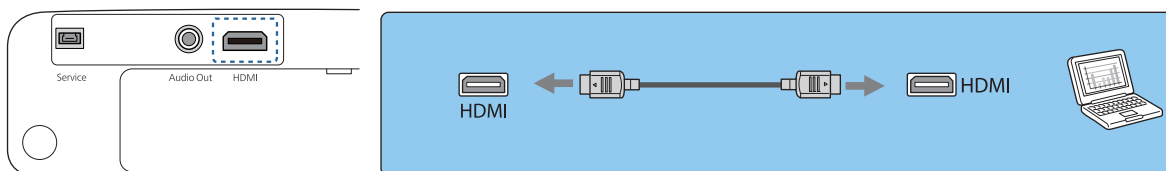

Connecting External Equipment

Connecting Bluetooth® devices

By connecting a Bluetooth-compatible audio device, you can output audio from streaming media players or video devices.

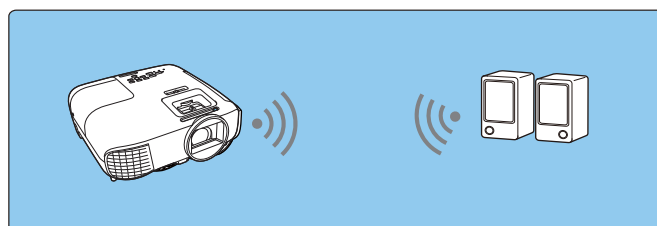

- 1 Press the [Menu] button to display menus in the order **Settings - HDMI Link - Audio Out Device**.

- 2 Use the up and down buttons to select **Projector**, and then press the [Enter] button to confirm the selection.



- 3 Display menus in the order **Settings - Bluetooth - Bluetooth Audio**.

- 4 Use the up and down buttons to select **On**, and then press the [Enter] button to confirm the selection.

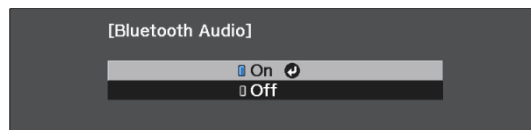

- 5 Turn on "pairing mode" on the Bluetooth device you want to connect to. See the documentation supplied with the Bluetooth device for more information.

- 6 Select **Search Bluetooth Device**. A list of available devices is displayed.

- 7 Use the up and down buttons to select the Bluetooth device you want to connect to, and then press the [Enter] button to connect.

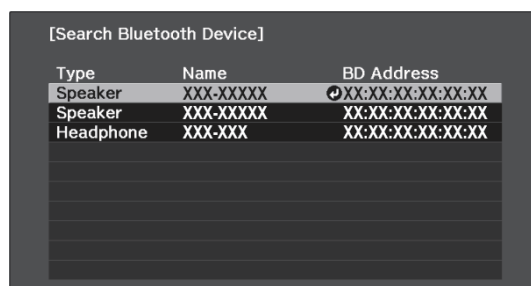

The next time you turn on the projector, it automatically connects to the last device it connected to. To change the connected device, repeat the procedure from step 5.

Bluetooth specifications

Version	Bluetooth Ver. 3.0
Output	Class 2
Communication distance	Approx. 10 m
Supported profiles	A2DP
Content protection	SCMS-T

Frequency used	2.4 GHz band (2.402 to 2.480 GHz)
Supported codecs	SBC, Qualcomm® aptX™ audio

 **Warning**

- Electromagnetic interference may cause medical equipment to malfunction. Before using the device, make sure there is no medical equipment in the vicinity.
- Electromagnetic interference may cause automatically controlled equipment to malfunction which could cause an accident. Do not use the device near automatically controlled equipment such as automatic doors or fire alarms.



- Connect a Bluetooth device that supports copyright protection (SCMS-T).
- You may not be able to connect depending on the standard and type of device.
- Even when connecting within the specified communication distance, connections can be lost due to the status of the signal.
- The communication method for Bluetooth uses the same frequency (2.4 GHz) as wireless LAN (IEEE802.11b/g) or microwave ovens. Therefore, if these devices are used at the same time, radio wave interference may occur, the image and audio may be interrupted, or communication may not be possible. If you do need to use these devices at the same time, make sure there is enough distance between them and the Bluetooth device.
- You cannot connect multiple Bluetooth devices to the projector at the same time.
- There is a delay in the audio output from any Bluetooth audio devices.

 **Connecting external speakers**

To output audio from external speakers, connect the speakers to the projector's Audio Out port with a commercially available audio cable.

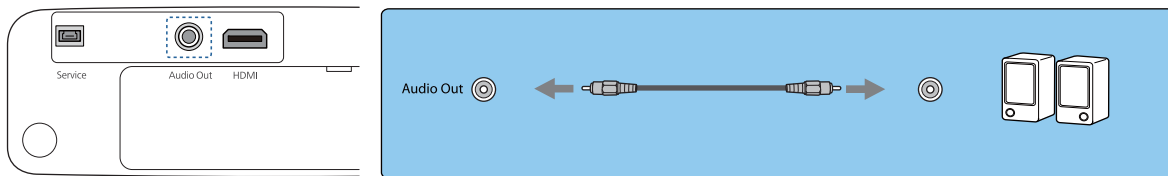

- To output audio from external speakers, set **Audio Out Device** to **Projector**.  **Settings - HDMI Link - Audio Out Device** [p.52](#)
- When an AV system is not connected to the projector, audio is output from the external speakers, even if **Audio Out Device** is set to **AV System**.

Preparing the Remote Control

Installing the Remote Control Batteries

Attention

- Check the positions of the (+) and (-) marks inside the battery holder to ensure the batteries are inserted the correct way.
- You cannot use other batteries except for AAA size manganese or alkaline.

- 1 Remove the battery cover.
While pushing the battery compartment cover catch, lift the cover up.

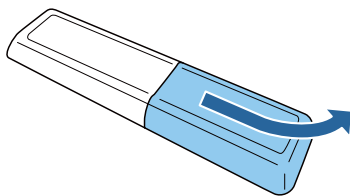

- 2 Replace the old batteries with new batteries.
Check the polarity of the batteries (+) and (-) before installing.

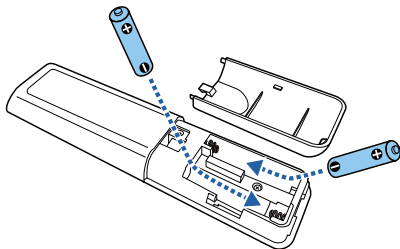

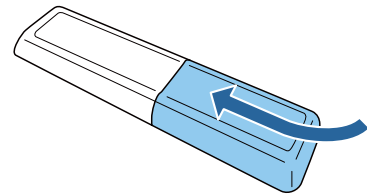

- 3 Reattach the battery cover.
Press the cover until it clicks into place.



 If delays in the responsiveness of the remote control occur or if it does not operate, it probably means that the batteries are becoming flat. Replace with two new batteries (AAA size manganese or alkaline batteries).

- 4 You need to pair (connect) the projector's remote control to the Android TV™ to operate it with the remote control. To perform pairing, follow the on-screen instructions and hold down the home button and the [Enter] button on the remote control at the same time for approximately three seconds.

 • If the projector's **HDMI Link** is set to **Off**, set it to **On**.  [p.47](#)

• The remote control indicator flashes while pairing.

Remote Control Operating Range

Operating range (left to right)

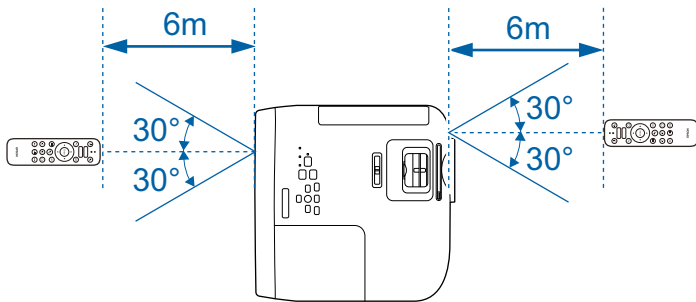

Operating range (top to bottom)

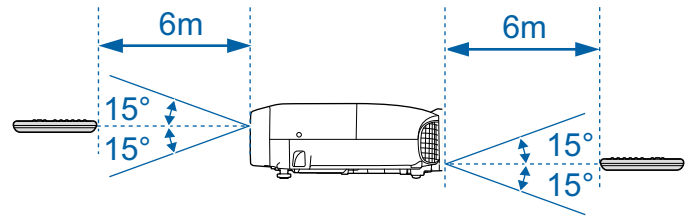

Projecting Images

Turning On the Projector

- 1 Connect the equipment to the projector.
- 2 Connect the power cord supplied.
- 3 Press the standby button on the remote control or the control panel to turn on the projector.

Remote control

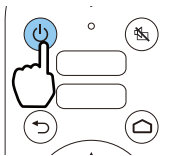

Control panel

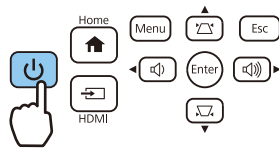

The projector's status indicator flashes blue as the projector warms up. Once the projector is warmed up, the standby indicator and the status indicator turn blue.



When **Direct Power On** is set to **On**, you can start projecting by simply connecting the power cord to the projector without having to press any buttons. **Extended - Operation - Direct Power On** p.54

- 4 Open the lens cover.

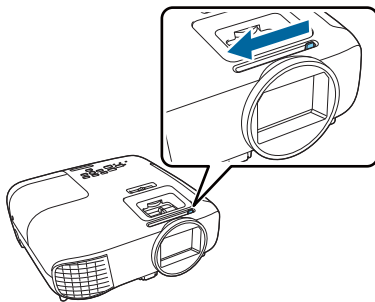

- 5 Turn on the connected equipment.

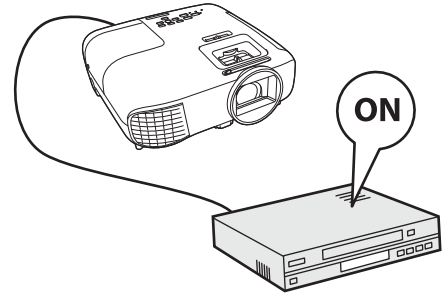

Warning

- Do not use the projector in locations where flammable or explosive gases such as those used in air dusters or insecticides may be present in the atmosphere. If flammable sprays have been used around the projector, be sure to ventilate the area thoroughly before turning on the projector.
- Do not look into the lens during projection. The powerful light emitted could cause damage to eyesight. Pay close attention to how your child behaves.
- Do not stand in front of the lens during projection. Clothes could be damaged due to the high temperature.
- Do not block the light from the projector with a book and so on during projection. Blocking the light from the projector may cause the item exposed to the light to become hot and melt, or cause burns or a fire to occur. Also, when light is reflected back into the projector, it can cause the lens to become hot and a malfunction to occur. If you need to stop projecting, use A/V Mute or turn off the projector.



- This projector provides a Child Lock function to prevent children from accidentally turning the power on and a Control Panel Lock function to prevent accidental operations and so on. **Settings - Lock Setting - Child Lock/Control Panel Lock p.52**
- When using at an altitude of 1500 m or more, set **High Altitude Mode to On.** **Extended - Operation - High Altitude Mode p.54**

■ If the target image is not projected

If the image is not projected, you can change the source using one of the following methods.

Remote control

Press the source button and select the target port.

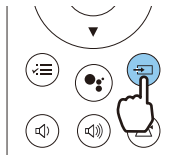

Control panel

Press the [Home] button to switch to the image from Android TV™.

Press the [HDMI] button to switch to the image from the HDMI port.

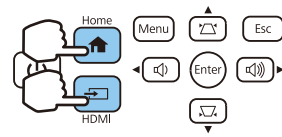

Turning Off

1 Turn off the connected equipment.

2 Press the standby button on the remote control or the control panel.

Remote control

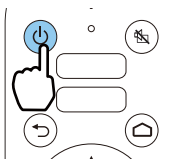

Control panel

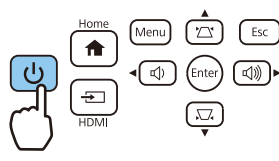

A confirmation message is displayed.

3 Press the standby button again.

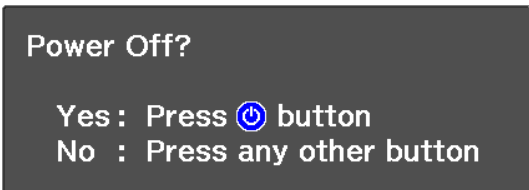

The status indicator flashes and the projector begins to cool down.

4 Wait until cool-down is complete.

When cool-down is complete, the status indicator stops flashing.

5 Disconnect the power cord.



- If the power cord is connected, some electricity is consumed even if no operations are made.
- When connecting the power cord again, wait a sufficient time interval.

6 Close the lens cover.

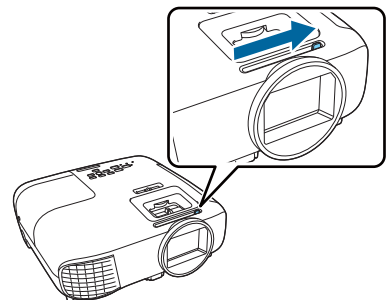

Adjusting the Projected Image



Since images are unstable immediately after the projector is turned on, before you make focus, zoom, or lens shift settings, we recommend waiting 30 minutes or more after starting to project the images.

Adjusting the Focus

Adjust the focus using the focus adjuster or the focus ring.

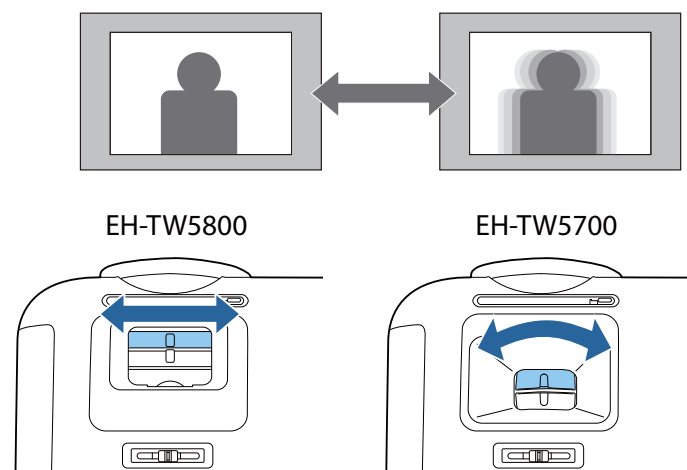

Adjusting the Projection Size (Adjust Zoom)

Adjust the size of the projected image using the zoom adjuster or the zoom ring.

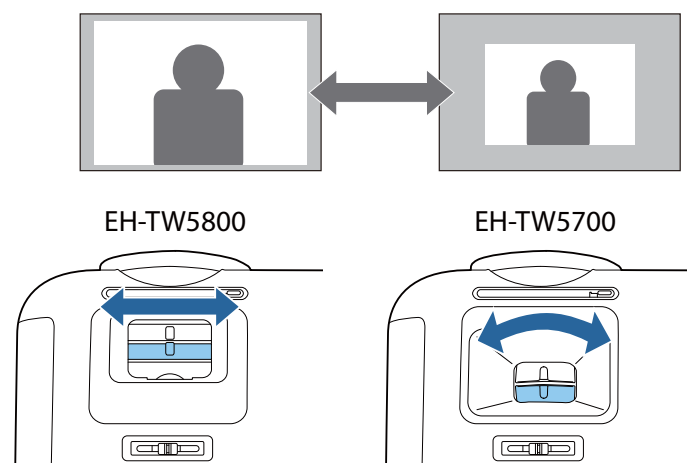

Adjust the Height of the Image

Press the foot release lever to extend the front adjustable foot. You can tilt the projector up to 11° to adjust image height.

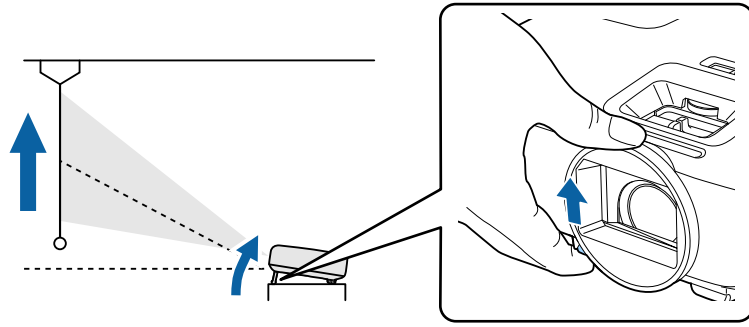

It becomes more difficult to focus the higher the tilt angle is. Use a moderate tilt angle.

Adjusting the Projector's Tilt

If the projected image is horizontally tilted (the left and right sides of the projected image are at different heights) when the projector is setup on a table, adjust the rear feet so that both sides are level with each other.

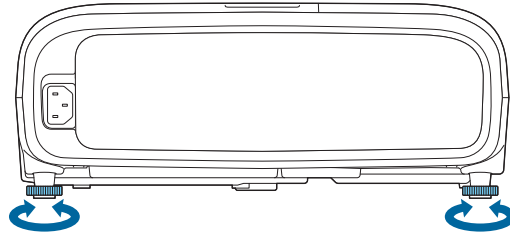

Adjusting the Position of the Image (Lens Shift)(EH-TW5800 Only)

If the projector cannot be installed directly in front of the screen, you can adjust the position of the image by using lens shift.

Turn the lens shift dial on the projector to adjust the position of the image.

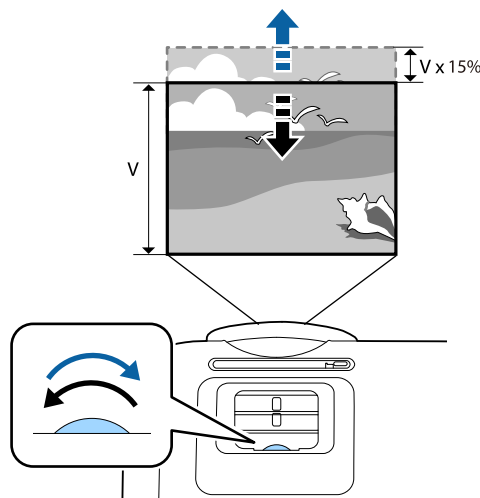

- When using lens shift to adjust the position of the image, adjust the image by moving it upward.
- When adjusting the projection position using the lens shift, you are recommended to install the projector in parallel with the screen.

Correcting Keystone Distortion

You can correct keystone distortion using one of the following methods.

Correct automatically	Auto V-Keystone	Automatically correct vertical keystone distortion.
Correct manually	H-Keystone Adjuster	Correct horizontal keystone distortion with the horizontal keystone adjuster.
	H/V-Keystone	Manually correct distortion in the horizontal and vertical directions independently.
	Quick Corner	Adjust the four corners of the projected image individually.

 • The projected image becomes smaller after correcting distortion. Increase the projection distance to fit the projected image to the screen size.

• Install the projector parallel with the screen without any loss in image quality. If you cannot install the projector parallel to the screen, adjust the shape of the image using H/V-Keystone correction.



• When correcting distortion, rotate the lens shift dial to adjust the lens position to the top edge. If the lens position is incorrect, the projection screen may be warped (EH-TW5800 only).

Correct automatically (Auto V-Keystone)

When the projector detects that it is tilted during projection, Auto V-Keystone automatically corrects any vertical keystone distortion. Two seconds after the projector is tilted, it displays an adjustment screen and then automatically corrects the projected image.

Auto V-Keystone can correct the projected image distortion in these conditions:



- Projection angle is less than 30° up or down.
- **Projection** is set to **Front**.  **Extended - Projection** p.54

 If you do not want to use the Auto V-Keystone function, set **Auto V-Keystone** to **Off**.  **Settings - Keystone - H/V-Keystone - Auto V-Keystone** p.52

Correct manually (H-Keystone Adjuster)

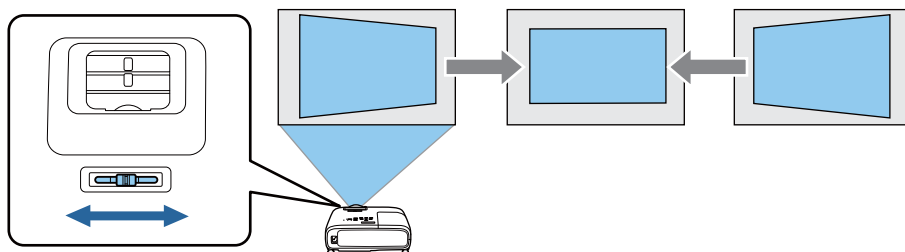
Move the horizontal keystone adjuster to the right or left to perform horizontal keystone correction.



 • When **Keystone** is set to **Quick Corner**, the H-Keystone Adjuster does not function. Set it to **H/V-Keystone**.  **Settings - Keystone** p.52

• You can correct images up to 30° left or right.

Correct manually (H/V-Keystone)

You can use the up/down/left/right buttons on the control panel to correct vertical and horizontal keystone distortion.

Press the up or down button to display the V-Keystone/H-Keystone gauges. When the gauges are displayed, press the up and down buttons to perform vertical correction, and press the left and right buttons to perform horizontal correction.

When the top or bottom is too wide

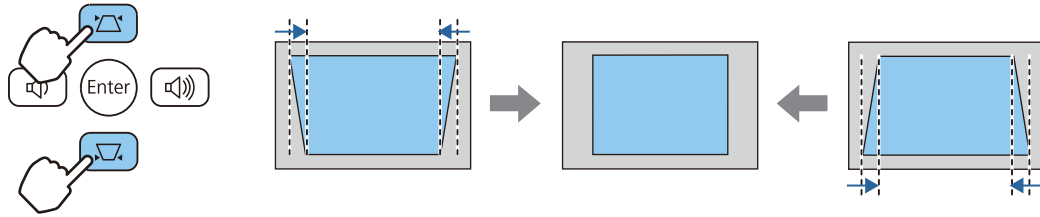

When the left or right is too wide

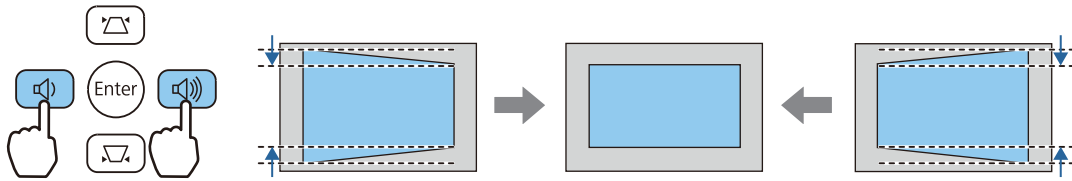

- You can correct images up to 30° right, left, up, or down.
- You can adjust the volume by pressing the V-Keystone/H-Keystone buttons when the gauges are not displayed. [p.32](#)
- You can also set H/V-Keystone from the Configuration menu. **Settings - Keystone - H/V-Keystone - V-Keystone/H-Keystone** [p.52](#)

Correct manually (Quick Corner)

You can use the projector's Quick Corner setting to correct the shape and size of an image that is unevenly rectangular.

1 Press the [Menu] button to display menus in the order **Settings - Keystone.**

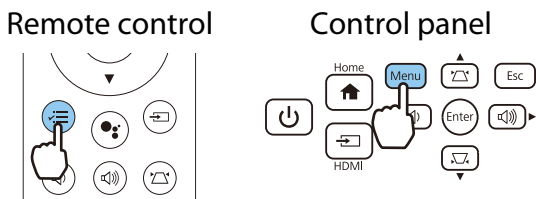

2 Use the up and down buttons to select **Quick Corner**, and then press the [Enter] button. Press the [Enter] button again if necessary.

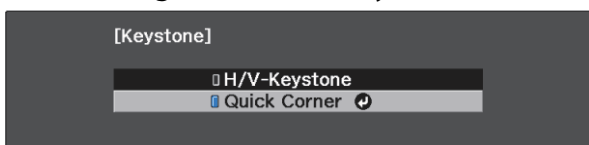

The area selection screen is displayed.

3 Use the up/down/left/right buttons to select the corner of the image you want to adjust. Then press the [Enter] button.

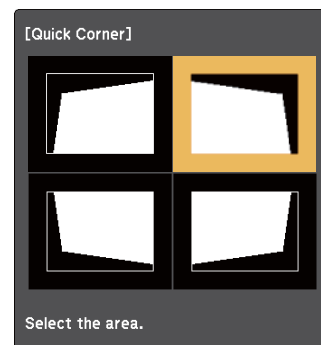

- To reset the Quick Corner corrections, hold down the [Esc] button for about two seconds while the area selection screen is displayed, and then select **Yes**.

- 4 Press the up/down/left/right buttons to adjust the shape of the image as necessary. Press the [Enter] button to return to the area selection screen.

 If you see this screen, you cannot adjust the shape any further in the direction indicated by the gray triangle.

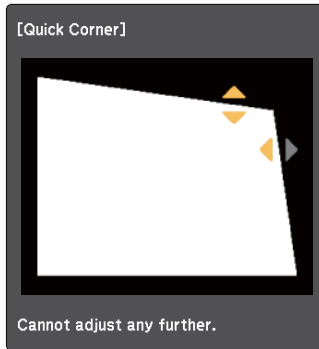

- 5 Repeat steps 3 and 4 as needed to adjust any remaining corners.

- 6 When you are finished, press the [Esc] button.

 After executing Quick Corner, the **Keystone** setting is now set to **Quick Corner** in the projector's **Settings** menu. When you press the up/down buttons on the control panel or the keystone button on the remote control, the area selection screen is displayed.

Adjusting the Volume

You can adjust the volume by using the volume buttons on the remote control or on the control panel.

Remote control

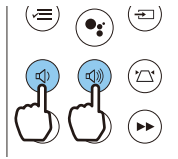

Control panel

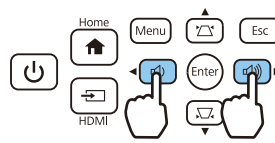

- You can also adjust the volume from the Configuration menu. **Settings - Sound - Volume p.52**
- When an AV System is connected to the projector and you want to adjust the volume for the AV system, set **HDMI Link** to **On** and **Audio Out Device** to **AV System**. **Settings - HDMI Link p.52**
- If you have used the remote control for Android TV™ to mute the volume on the Android TV™, you will not be able to turn it up using the projector remote control. Increase the volume using the remote control for Android TV™ before you make adjustments.

Caution

Do not start at high volume.
A sudden excessive volume may cause loss of hearing. Always lower the volume before powering off, so that you can power on and then gradually increase the volume.

Hiding the Image and Muting the Audio Temporarily (A/V Mute)

You can temporarily stop projection and mute any sound by pressing the A/V Mute button on the remote control or by closing the lens cover. To turn the image and sound back on, press the button again or open the lens cover.

Remote control

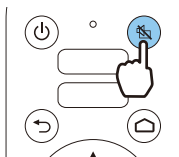

Main unit

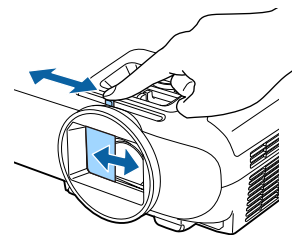

- For movies, the image and audio continue to play even during A/V Mute. You cannot resume projection from the point that you muted the video and audio using the A/V mute button.
- When outputting audio from an AV system and you want to adjust the volume for the AV system, set **HDMI Link** to **On** and **Audio Out Device** to **AV System**. **Settings - HDMI Link p.52**

Adjusting the Image

Selecting the Projection Quality (Color Mode)

You can obtain the optimum image quality to suit your surroundings when projecting. The brightness of the image varies depending on the mode selected.

- 1 Press the [Menu] button to display menus in the order **Image - Color Mode**.

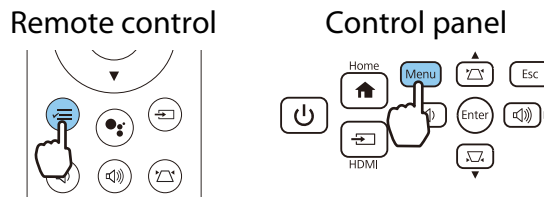

- 2 Use the up and down buttons to select a mode, and then press the [Enter] button to confirm the selection.

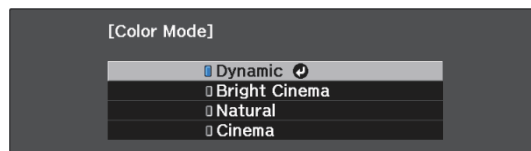

Mode	Application
Dynamic	This is the brightest mode. Best for prioritizing brightness.
Bright Cinema	Best for projecting vivid images.
Natural	Best for faithfully reproducing the color of the source image.
Cinema	Best for enjoying content such as movies.

Switching the Screen Between Full and Zoom (Aspect)

You can change the **Aspect** of the projected image to match the input signal's type, aspect ratio, and resolution.

The available settings vary depending on the image signal currently being projected.



Note that using the aspect ratio function of the projector to reduce, enlarge, or split the projected image for public viewing with the aim of making a profit may infringe upon the rights of the copyright holder of that image based on copyright law.

- 1 Press the [Menu] button to display menus in the order **Signal - Aspect**.

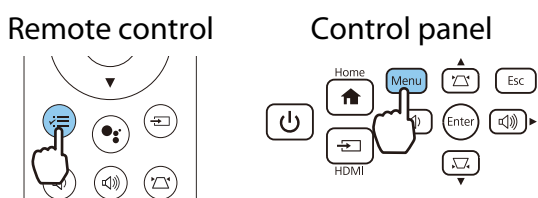

- Use the up and down buttons to select the aspect mode, and then press the [Enter] button to confirm the selection.

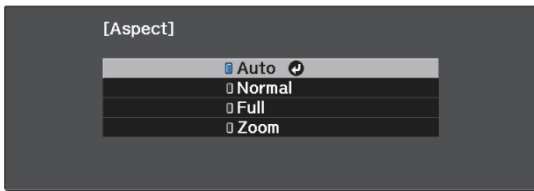

Auto may not be available depending on the type of input signal.

By normally selecting **Auto**, the optimum aspect is used to display the input signal. Change the setting if you want to use a different aspect.

The table below shows the image projected on a 16:9 screen.

Aspect Mode	Aspect Ratio for Input Signal		
	16:10	16:9	4:3
Normal			
Full			
Zoom			

Adjusting the Sharpness

You can make the image clearer.

- Press the [Menu] button to display menus in the order **Image - Sharpness**.

Remote control



Control panel

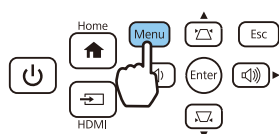

The **Sharpness** adjustment screen is displayed.

- Use the left and right buttons to make adjustments.

The image is enhanced when moved to the right (positive) and softer when moved to the left (negative).



- Press the [Menu] button to exit the menu.

Adjusting Image Resolution (Image Enhancement)

You can adjust the resolution of the image using the Image Enhancement function.

The following contents can be adjusted.

Image Preset Mode	Select the settings prepared in advance as the settings for Noise Reduction , MPEG Noise Reduction , and Detail Enhancement .
Noise Reduction*1 *2	Smooths out rough images.
MPEG Noise Reduction*1 *2	Reduces dot and block noise that occurs in outlines when projecting MPEG movies.
Detail Enhancement*2	Enhances the contrast in an image to create a more emphatic texture and material feel.

*1 This can only be set when **Signal - Advanced- Image Processing** is set to **Fine**.

*2 This can be set at any time except when **Image Preset Mode** is set to **Off**.

- 1 Press the [Menu] button to display menus in the order **Image - Image Enhancement**.

Remote control

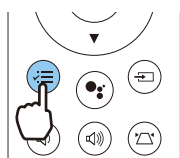

Control panel

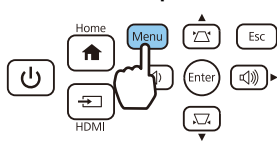

- 2 Use the up and down buttons to select the item you want to adjust, and then press the [Enter] button to confirm the selection.

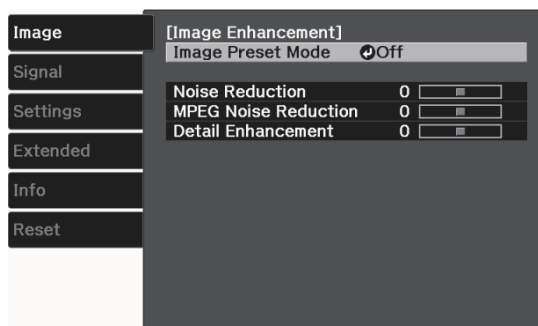

- 3 Use the left and right buttons to make adjustments.

Press the [Esc] button to adjust another item.



- 4 Press the [Menu] button to exit the menu.

Setting Auto Iris

By automatically setting the luminance according to the displayed image, you can enjoy deep and rich images.

You can select the luminance adjustment tracking for changes in brightness in the displayed image from **Normal** to **High Speed**.

- 1 Press the [Menu] button to display menus in the order **Image - Auto Iris**.

Remote control



Control panel

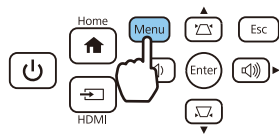

- 2 Use the up and down buttons to select the item, and then press the [Enter] button to confirm the selection.

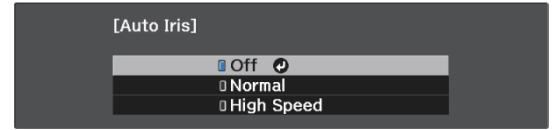

Depending on the image, you may hear the Auto Iris operating, but this is not a malfunction.

Setting Frame Interpolation

You can play fast moving images smoothly by automatically producing intermediate frames between the original frames.

Frame Interpolation is available under the following conditions.

- When **Image Processing** is set to **Fine**. 🖱️ **Signal - Advanced - Image Processing** p.51
- **Image Preset Mode** is set to anything other than **Off**. 🖱️ **Image - Image Enhancement - Image Preset Mode** p.50
- When inputting 2D signals or 3D signals (1080p 24 Hz). 🖱️ p.78

- 1 Press the [Menu] button to display menus in the order **Image - Image Enhancement - Frame Interpolation**.

Remote control

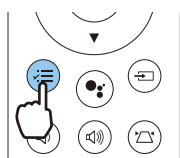

Control panel

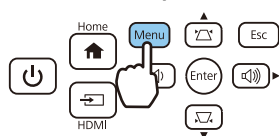

- 2 Use the up and down buttons to select the item, and then press the [Enter] button to confirm the selection.

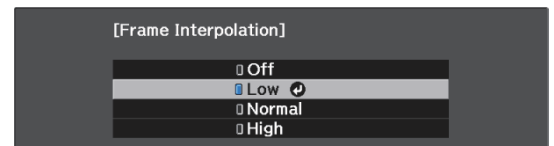

Setting the Image Processing Speed

Improves the response speed for images projected at high-speed, such as games.

This is only available when receiving a progressive signal input.

- 1 Press the [Menu] button to display menus in the order **Signal - Advanced - Image Processing**.

Remote control



Control panel

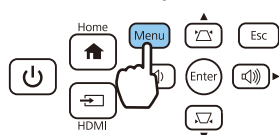

- 2 Use the up/down buttons to switch between **Fine** and **Fast**.





- This does not support 3D images.
- When **Image Processing** is set to **Fast, Noise Reduction, MPEG Noise Reduction,** and **Frame Interpolation** are fixed at **Off**.

Adjusting the Color

Adjusting the Color Temp.

Adjusts the tint for the images. Make adjustments if the image is a little too blue or too red and so on.

- 1 Press the [Menu] button to display menus in the order **Image - White Balance - Color Temp.**

Remote control

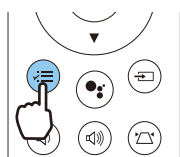

Control panel

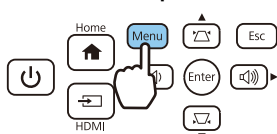

- 2 Use the left and right buttons to make adjustments.

Blue tints grow stronger as the value is increased, and red tints grow stronger as the value is reduced.



Adjusting the RGB (Offset and Gain)

You can adjust the brightness of dark areas (Offset) and bright areas (Gain) for R (red), G (green), and B (blue).

- 1 Press the [Menu] button to display menus in the order **Image - White Balance - Custom.**

Remote control



Control panel

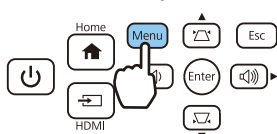

- 2 Use the up and down buttons to select the item, and then use the left and right buttons to make the adjustments.

The image becomes brighter when moved to the right (positive) and darker when moved to the left (negative).

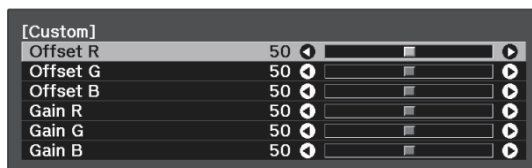

Offset	When the image is made brighter, shading for the darker sections is more vividly expressed. When the image is made darker, the image appears more full-bodied but shading for the darker sections is harder to distinguish.
Gain	When the image is made brighter, the bright sections become whiter and shading is lost. When the image is made darker, shading for the bright sections is more vividly expressed.

Adjusting Hue, Saturation, and Brightness

You can adjust the hue, saturation, and brightness for each of the R (red), G (green), B (blue), C (cyan), M (magenta), and Y (yellow) colors.

Hue	Adjusts the overall color of the image to be blue, green, or red.
Saturation	Adjusts the overall vividness of the image.
Brightness	Adjusts the overall color brightness of the image.

- 1 Press the [Menu] button to display menus in the order **Image - Advanced - RGBCMY**.

Remote control

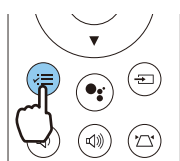

Control panel

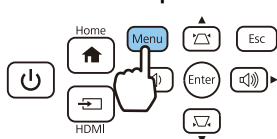

- 2 Use the up and down buttons to select the color you want to adjust, and then press the [Enter] button to confirm the selection.

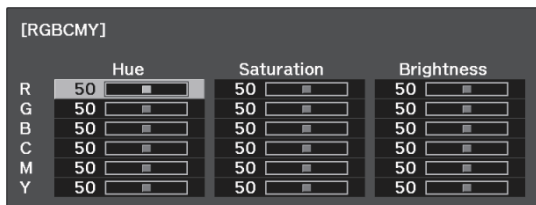

- 3 Use the up and down buttons to select **Hue, Saturation, or Brightness**.

- 4 Use the left and right buttons to make adjustments.

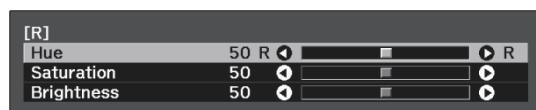

Press the [Esc] button to adjust another color.

- 5 Press the [Menu] button to exit the menu.

Adjusting the Gamma

You can adjust slight coloration differences that may occur due to the device being used when the image is displayed.

You can set it by using one of the following methods.

- Select and adjust the correction value
- Adjust using the gamma adjustment graph

■ Select and adjust the correction value

- 1 Press the [Menu] button to display menus in the order **Image - Advanced - Gamma**.

Remote control



Control panel

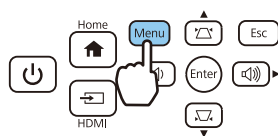

- 2 Use the up and down buttons to select the correction value, and then press the [Enter] button to confirm the selection.

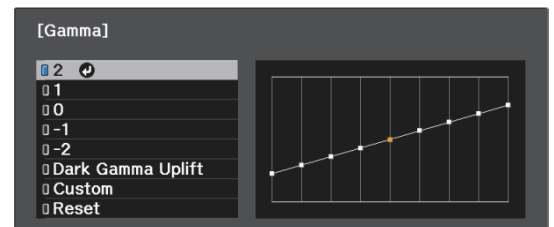

The larger the value, the lighter the dark portions of the image become, but bright areas may appear discolored. The upper part of the gamma adjustment graph becomes rounded. The smaller the value, the darker the bright portions of the image become. The lower part of the gamma adjustment graph becomes rounded.



- The horizontal axis of the gamma adjustment graph shows the input signal level, and the vertical axis shows the output signal level.
- Select **Dark Gamma Uplift** to adjust the tone of dark areas for greater visibility.
- Select **Reset** to return the adjustments to their default values.

Adjust using the gamma adjustment graph

Select a tone point on the graph and make adjustments.

- 1 Press the [Menu] button to display menus in the order **Image - Advanced - Gamma - Custom.**

Remote control



Control panel

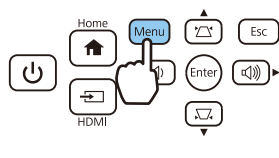

- 2 Use the left and right buttons to select the tone you want to adjust from the graph.

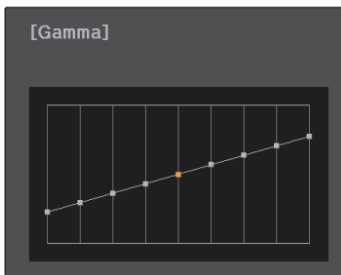

Select the left side of the graph to adjust the dark areas of the image. Select the right side of the graph to adjust the light areas of the image.

- 3 Use the up and down buttons to adjust the brightness, and then press the [Enter] button to confirm the selection.



Raise the tone point to make it brighter, and lower it to make it darker.

Viewing the Image at the Saved Image Quality (Memory Function)

Saving a Memory

By using the memory function, you can register settings for **Image** from the Configuration menu, and then load them when necessary.

1 Make the settings or adjustments you want to register.

2 Press the [Menu] button to display menus in the order **Settings - Memory**.

Remote control



Control panel

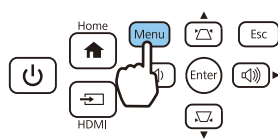

3 Use the up and down buttons to select **Save Memory**, and then press the [Enter] button to confirm the selection.

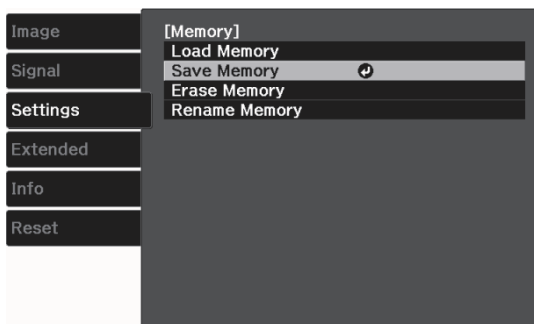

4 Use the up and down buttons to select the memory name you want to save, and then press the [Enter] button to confirm the selection.

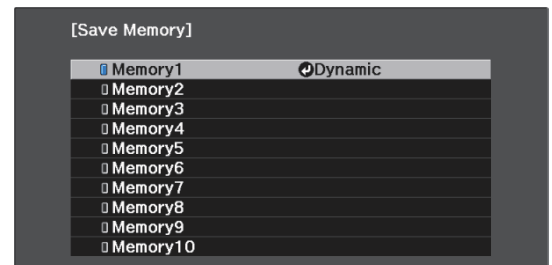

The current projector settings are saved to the memory.

If the mark on the left of the memory name is turned aqua, it means the memory has already been registered. When you select a registered memory, a message is displayed asking you to confirm that you want to overwrite the memory. If you select **Yes**, the previous content is erased and the current settings are saved.

Loading, Deleting, and Renaming a Memory

You can load, delete, and rename registered memories.

- 1 Press the [Menu] button to display menus in the order **Settings - Memory**.

Remote control



Control panel

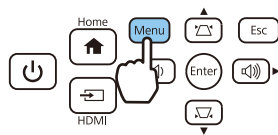

- 2 Select the target function on the screen displayed.

Function	Explanation
Load Memory	Loads the saved memory. When you select a memory and press the [Enter] button, the settings applied to the current image are replaced with the settings from the memory.
Erase Memory	Erases a saved memory. When you select a memory name and press the [Enter] button, a message is displayed. Select Yes , and then press the [Enter] button to erase the selected memory.
Rename Memory	Changes the memory name. Select the memory name you want to change, and then press the [Enter] button. Enter the memory name using the soft keyboard. When you have finished, move the cursor over Finish, and then press the [Enter] button.

Enjoying 3D Images

Preparing to View 3D Images

To view 3D images, be sure to prepare a pair of commercially available 3D Glasses with an active shutter system that supports radio waves (RF/Bluetooth) communication system in advance.

Check the following before viewing 3D images.

- Set **3D Display** to **Auto** or **3D**.  **Signal - 3D Setup - 3D Display** p.51
- Pair 3D Glasses.

This projector supports the following 3D formats.

- Frame Packing
- Side by Side
- Top and Bottom

If the 3D image cannot be viewed

The projector automatically projects a 3D image when detecting a 3D format.

Some 3D TV broadcasts may not contain 3D format signals. If this happens, follow the steps below to set the 3D format.

- 1 Press the [Menu] button to display menus in the order **Signal - 3D Setup**.

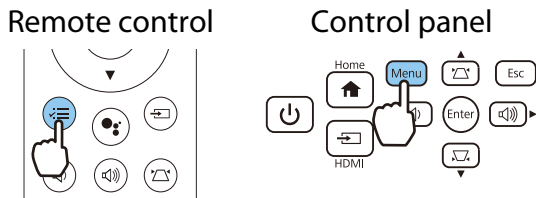

- 2 Set **3D Display** to **3D**.

- 3 Press the [Esc] button to return to the previous screen.

- 4 Select **3D Format**, and then select the 3D format on the AV device.

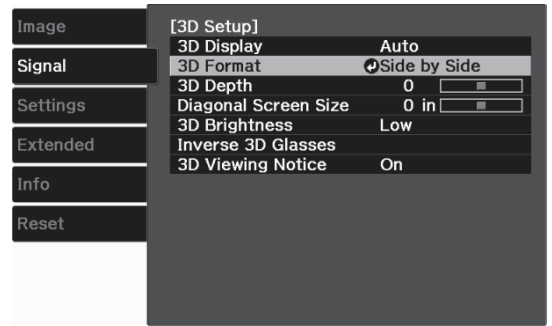



- If you are using a device or cable that does not support 3D images, 3D projection cannot be performed.
- For details on 3D format settings on the AV device, see the documentation supplied with the AV device.
- When the 3D format has not been correctly set up, an image will not be correctly projected as shown below.

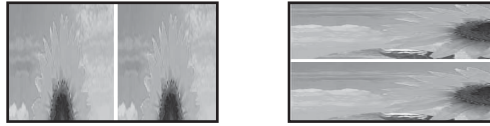

- If a 3D image is not projected correctly even when a 3D format is set, the synchronization timing for the 3D Glasses may be inverted. Inverse the synchronization timing using **Inverse 3D Glasses**.
☛ **Signal - 3D Setup - Inverse 3D Glasses** [p.51](#)
- How a 3D image is perceived varies depending on the individual.
- When you start projecting a 3D image, a notification about viewing 3D images is displayed. You can turn off this warning by setting **3D Viewing Notice** to **Off**. ☛ **Signal - 3D Setup - 3D Viewing Notice** [p.51](#)
- During 3D projection, the following Configuration menu functions cannot be changed. Frame Interpolation, Aspect (Normal fixed), Overscan (Off fixed)
- How the 3D image is viewed may change depending on the temperature of the surroundings and how long the lamp has been used. Refrain from using the projector if the image is not projected normally.

Using 3D Glasses

You can view 3D images by using a pair of commercially available 3D Glasses (with an active shutter system that supports radio waves (RF/Bluetooth) communication system).

To view 3D images, you first need to pair the 3D Glasses with the projector. See the User's Guide supplied with your 3D Glasses for more information.

Notifications Regarding Viewing 3D Images

Note the following important points when viewing 3D images.



Caution

Viewing Time

- When viewing 3D images, always take periodic breaks during extended viewing. Long periods of viewing 3D images may cause eye fatigue. The amount of time and frequency of such breaks varies from person to person. If your eyes still feel tired or uncomfortable even after taking a break from viewing, stop viewing immediately.

 **Caution**

Watching 3D Images

- How a 3D image is perceived varies depending on the individual. Stop using the 3D function if you feel strange or cannot see in 3D.
Continuing to view the 3D images could cause you to feel unwell.
- If your eyes feel fatigued or uncomfortable when viewing 3D images, stop viewing immediately.
Continuing to view the 3D images could cause you to feel unwell.
- When viewing 3D images be sure to always wear 3D Glasses. Do not attempt to view 3D images without 3D Glasses.
Doing so could cause you to feel unwell.
- Do not place any breakable or fragile objects around you when using 3D Glasses.
3D images may cause you to move your body involuntarily, resulting in damage to nearby items or personal injury.
- Only wear 3D Glasses when viewing 3D images. Do not move around while wearing 3D Glasses.
Your vision may appear darker than normal, causing you to fall or injure yourself.
- Try to stay as level with the viewing screen as possible when viewing 3D images.
Viewing 3D images at an angle reduces the 3D effect and may cause you to feel unwell due to unintended color changes.
- When viewing 3D images in a room with fluorescent or LED lighting, you may see flashing or flickering throughout the room. If this should occur, reduce the lighting until the flickering goes away or turn off the lights completely when viewing 3D images. In some very rare cases, this flickering could trigger seizures or fainting for some individuals. If you begin to feel uncomfortable or unwell at any time when viewing 3D images, stop immediately.
- Stay at least three times the height of the screen away from the screen when viewing 3D images.
The recommended viewing distance for an 80-inch screen is at least 3 meters, and at least 3.6 meters for a 100-inch screen.
Sitting or standing any closer than the recommended viewing distance may result in eye fatigue.

 **Caution**

Health Risks

- You should not view 3D images if you are sensitive to light, have a heart condition, or are unwell.
Doing so could aggravate your pre-existing conditions.

 **Caution**

Recommended Age of Use

- The minimum recommended age to view 3D images is six years old.
- Children under the age of six are still developing and viewing 3D images may cause complications. Consult your doctor if you have any concerns.
- Children viewing 3D images through 3D Glasses should always be accompanied by an adult. It is often difficult to tell when a child is feeling tired or uncomfortable, which could result in them feeling suddenly unwell.
Always check with your child to ensure that they are not experiencing any eye fatigue during viewing.

Using the HDMI Link Function

HDMI Link Function

When an AV device that meets the HDMI CEC standards is connected to the projector's HDMI port, you can perform linked operations such as linked power on and volume adjustment for the AV amplifier from one remote control.

- As long as the AV device meets the HDMI CEC standards, you can use the HDMI link function even if the AV amplifier in-between does not meet the HDMI CEC standards.
- Up to 1 multi-media player that meets the HDMI CEC standards can be connected at the same time.

Connection Example

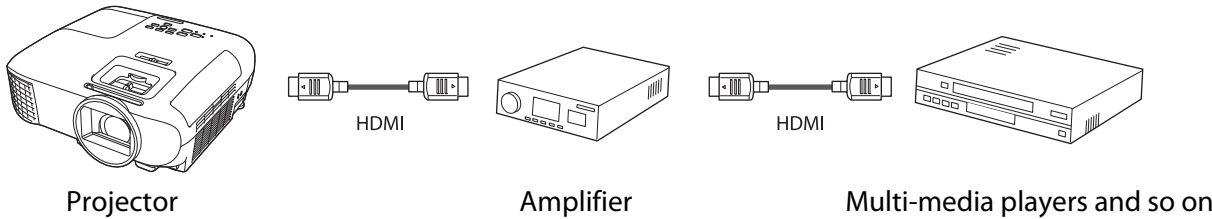

HDMI Link Settings

When **HDMI Link** is set to **On**, you can perform the following operations. **Settings - HDMI Link - HDMI Link p.52**

- Input Change Link**
Switches the input source of the projector to HDMI when content is played back on the connected device.
- Connected Devices Operations**
Using the projector's remote control, you can perform operations such as Play, Stop, Fast Forward, Rewind, Next Chapter, Previous Chapter, Pause, Volume Adjustment, and Audio Mute.

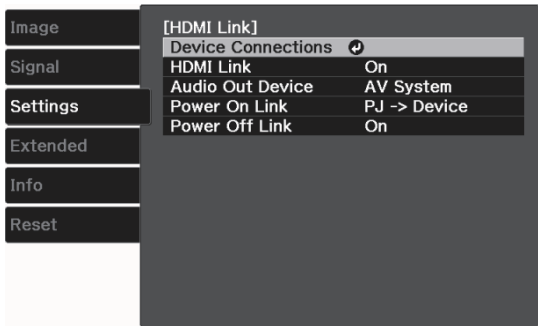

You can also select the following functions from the **HDMI Link** screen.

Function	Explanation
Audio Out Device	<p>Selects which device outputs audio.</p> <p>Projector: Select this to output audio from the projector's built-in speakers or from an external speaker connected to the Audio Out port.</p> <p>AV System: Select this to output audio from an AV amplifier that supports the HDMI CEC standards.</p>
Power On Link	<p>When Power On Link is set, operations are linked as shown below.</p> <ul style="list-style-type: none"> When the projector is turned on, the connected devices are also turned on. Also, when the connected devices are turned on and content is played back, the projector turns on.

Function	Explanation
Power Off Link	<p>When Power Off Link is set to On, when the projector is turned off, the connected devices are also turned off.</p> <ul style="list-style-type: none"> • This only works when the connected device's CEC power link function is enabled. • Note that depending on the status of the connected device (for example, if it is recording), the device may not power off.

 To use the HDMI Link function, you must configure the connected device. See the documentation supplied with the connected device for more information.

Connecting

You can check the connected devices that are available for HDMI Link, and select on the device you want to project the image from. Devices that can be controlled by HDMI Link automatically become the selected device.

Before displaying the list of connected devices, check that **HDMI Link** is set to **On**.  **Settings - HDMI Link - HDMI Link** p.52

1 Press the [Menu] button to display menus in the order **HDMI Link - Device Connections**.

Remote control



Control panel

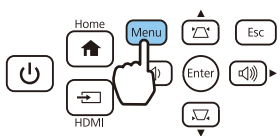



The **Device Connections** list is displayed.

Devices that have an aqua icon to their left are linked by HDMI Link.

If the device name cannot be determined this field is left blank.

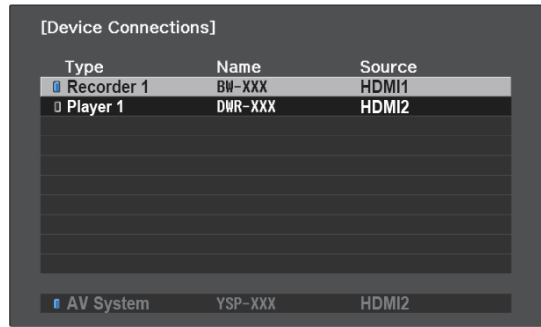
2 Select the device you want to operate using the HDMI Link function.



 • If the cable does not meet the HDMI standards, operations are not possible.

• Some connected devices or functions of those devices may not operate properly even if they meet the HDMI CEC standards. See the documentation and so on supplied with the connected device for more information.

Configuration Menu Functions

Configuration Menu Operations

On the Configuration menu, you can make adjustments and settings for Signal, Image, Input Signal, and so on.

1 Press the [Menu] button.

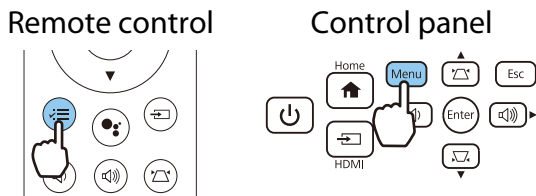

The Configuration menu is displayed.

2 Use the up and down buttons to select the top menu on the left, and then press the [Enter] button to confirm the selection.

When you select the top menu on the left, the sub menu on the right changes.

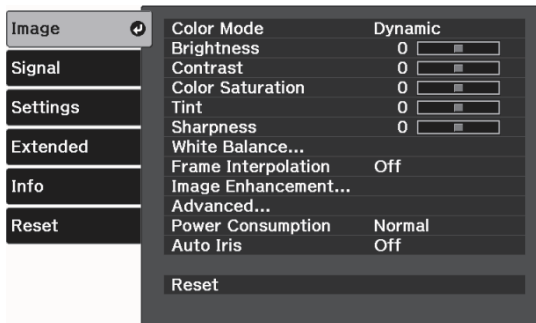

The line at the bottom is a guide for operations.

3 Use the up and down buttons to select the sub menu on the right, and then press the [Enter] button to confirm the selection.

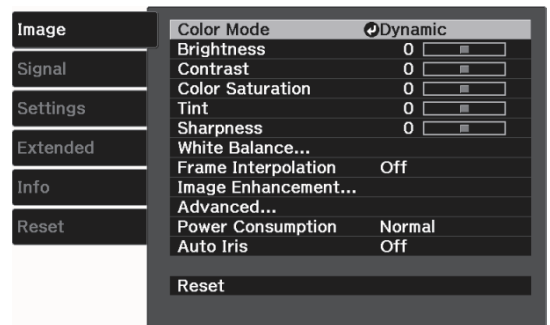

The adjustment screen for the selected function is displayed.

4 Use the up/down/left/right buttons to adjust the settings.

Ex.) Adjustment bar



Ex.) Choices

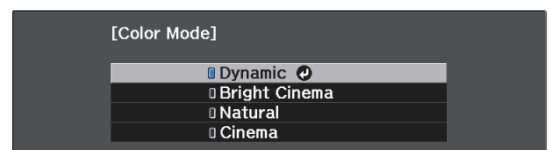

Press the [Enter] button on an item displaying this to change to the selection screen for that item.













Press the [Esc] button to return to the previous level.

5 Press the [Menu] button to exit the menu.

Configuration Menu Table

If there is no image signal being input, you cannot adjust items related to the **Image** or **Signal** in the Configuration menu. Note that the items displayed for the **Image**, **Signal**, and **Info** vary depending on the image signal being projected.



Image menu

Function	Menu/Settings		Explanation
Color Mode	Dynamic, Bright Cinema, Natural, Cinema		Select a color mode based on your surroundings and the image you are projecting.  p.33
Brightness			Adjusts the brightness when the image appears too dark.
Contrast			Adjusts the contrast between light and shade in the images. By increasing the contrast, the images become vivid.
Color Saturation			Adjusts the color saturation for the images.
Tint			Adjusts the tint for the images.
Sharpness			Adjusts the image sharpness.
White Balance	Color Temp.		Adjusts the overall color of the image. The image is tinted blue for high values, and tinted red for low values.
	Custom		Adjusts the offset and gain for each R, G, and B color.
Frame Interpolation	Off, Low, Normal, High		Adjusts the smoothness of the movement of the image.
Image Enhancement	Image Preset Mode	Off, Preset 1 to Preset 5	Select the settings prepared in advance as the settings for Noise Reduction , MPEG Noise Reduction , and Detail Enhancement .
	Noise Reduction		Adjusts the roughness of the image.
	MPEG Noise Reduction		Smooths out rough images in MPEG format.
	Detail Enhancement	Strength, Range	Creates a more emphatic texture and material feel of the image.
Advanced	Gamma	2, 1, 0, -1, -2, Dark Gamma Uplift, Custom*, Reset	Performs gamma adjustments. You can select a raw value or adjust using a custom value.  p.40
	RGBCMY	R/G/B/C/M/Y	Hue, Saturation, Brightness  Adjusts the Hue, Saturation, and Brightness for each R, G, B, C, M, and Y color.  p.39

Function	Menu/Settings	Explanation
Power Consumption	Normal, ECO	You can set the lamp brightness to one of two settings. Select ECO if the images being projected are too bright. When ECO is selected, power consumption during projection decreases, and fan rotation noise is reduced.
Auto Iris	Off, Normal, High Speed	You can change the luminance adjustment tracking for changes in brightness in the displayed image.  p.35
Reset	Yes, No	Resets the adjustment values of Image set in the current Color Mode to the default settings.

* Settings are saved for each type of input source or Color Mode.

 Signal menu



Function	Menu/Settings		Explanation
3D Setup	3D Display	Auto, 3D, 2D	To view 3D images, set this to Auto or 3D .  p.44
	3D Format	Side by Side, Top and Bottom	Sets the 3D format for the input signal.
	3D Depth	-10 to 10	Sets the depth for the 3D image.
	Diagonal Screen Size	60 to 300	Sets the projection size for the 3D image. By matching this to the actual size, you can achieve the optimum 3D effect.
	3D Brightness	Low, Medium, High	Sets the brightness for the 3D image.
	Inverse 3D Glasses		Reverses the synchronization timing for the left/right shutters on the 3D Glasses and the left/right images. Enable this function if the 3D effect is not displayed correctly.
	3D Viewing Notice	On, Off	Turns on or off the notification that is displayed when viewing 3D content.
Aspect ^{*1}	Auto ^{*2} , Normal, Full, Zoom		Selects the aspect mode.  p.33
Overscan ^{*1}	Auto, Off, 4%, and 8%		Changes the output image ratio (the range of the projected image). <ul style="list-style-type: none"> • Off, 4%, 8%: Sets the range of the image. When set to Off, the entire range of the image is projected. Depending on the image signal, you may notice noise at the top and bottom of the image. • Auto: Automatically sets to Off or 8% depending on the input signal.



Function	Menu/Settings		Explanation
Advanced	Video Range*1	Auto, Limited (16-235), Full (0-255)	When set to Auto , the video level for the DVD input signal is automatically detected and set. If you experience under or overexposure when set to Auto , set the video level of the projector to match that of the DVD/Blu-ray disc player's video level. Your player may be set to Normal (Limited) or Expand (Full).
	EDID	Normal, 21:9	Lets you change the EDID settings. Restart the projector after changing the EDID.
	Image Processing	Fine, Fast	Improves the response speed for images projected at high-speed, such as games.
Reset	Yes, No		Resets all Signal settings except for Diagonal Screen Size , 3D Viewing Notice , and Aspect .

*1 Settings are saved for each type of input source or signal.

*2 You may not be able to make selections depending on the source or type of signal.

 Settings menu

Function	Menu/Settings		Explanation	
Keystone	H/V-Keystone	V-Keystone	-60 to 60	Corrects keystone distortion.  p.29 <ul style="list-style-type: none"> • H/V-Keystone: Manually corrects horizontal and vertical distortions.  p.29 • Quick Corner: Corrects the corners of the projected image individually.  p.30
		H-Keystone	-60 to 60	
		Auto V-Keystone	On, Off	
		H-Keystone Adjuster	On, Off	
	Quick Corner	-		
Sound	Volume	0 to 20		Adjusts the volume of the projector's built-in speaker. You can also adjust the volume for the Bluetooth audio device connected to the projector. You need to adjust the volume of the built-in speaker and the Bluetooth audio device individually.
	Sound Mode	Standard, Vocal, Music, Movie		Selects the sound mode according to the content you want to play. This is not available when audio is being output from a Bluetooth audio device.

Function	Menu/Settings		Explanation
HDMI Link	Device Connections	-	Displays a list of devices connected to the HDMI ports.
	HDMI Link	On, Off	Enables or disables the HDMI Link function.
	Audio Out Device	Projector, AV System	Selects which device outputs audio.  p.47
	Power On Link	Off, Bidirectional, Device -> PJ, PJ -> Device	<p>Sets the link function when the power is turned on.</p> <ul style="list-style-type: none"> To turn on the projector when you operate the connected device, select Bidirectional or Device -> PJ. To turn on the connected device when you turn on the projector, select Bidirectional or PJ -> Device.
	Power Off Link	On, Off	Sets whether or not to power off connected devices when the projector is turned off.
Bluetooth	Search Bluetooth Device	-	Searches for available Bluetooth devices and displays them as a list.
	Bluetooth Audio	On, Off	<p>Enables or disables audio output from Bluetooth audio devices.</p> <p>Setup cannot be performed in the following cases.</p> <ul style="list-style-type: none"> When Audio Out Device from the HDMI Link menu is set to AV System
	Connected Device	-	Displays information on the connected Bluetooth audio device.
Lock Setting	Child Lock	On, Off	<p>This locks the standby button on the projector's control panel to prevent children from turning on the projector by accident. You can turn on the power when locked by holding down the standby button for approximately three seconds. You can still turn off the device using the standby button or perform operations with the remote control as usual.</p> <p>If changed, this setting is enabled after you power off the projector and the cool-down process is complete.</p> <p>Note that even if Child Lock is set to On, the projector still turns on when the power cord is connected if Direct Power On is set to On.</p>
	Control Panel Lock	Full Lock, Partial Lock, Off	<p>Full Lock: Disables all of the projector's buttons. Partial Lock: Disables all of the projector's buttons except for the standby button.</p> <p> is displayed on the screen if buttons are pressed while the projector is locked. To unlock, press and hold the standby button on the control panel for at least 7 seconds.</p> <p>If changed, this setting is enabled once you close the Configuration menu.</p>

Function	Menu/Settings		Explanation
Memory	Load Memory	Memory1 to Memory10	Loads the settings saved in Save Memory to adjust the image.
	Save Memory	Memory1 to Memory10	Saves the settings made in Image to a memory.
	Erase Memory	Memory1 to Memory10	Erases a saved memory.
	Rename Memory	Memory1 to Memory10, Default, DVD, VCR, SDTV, HDTV, Cinema, Sports, Music, Anime, Game, Custom	Changes the saved memory name.
Reset	Yes, No		Resets all Settings except for Audio Out Device , Power On Link , Power Off Link , and Memory .

■ Extended menu

Function	Menu/Settings		Explanation
Display	Messages	On, Off	<p>Sets whether or not to display the following messages (On or Off).</p> <ul style="list-style-type: none"> Item names for image signals, color modes, and aspect ratios. If the internal temperature is rising when no image signal is being input or an unsupported signal is detected.
	Display Background	Black, Blue, Logo	Selects the screen status when no image signal is being input.
	Startup Screen	On, Off	Sets whether or not to show a startup screen when projection begins (On or Off). If changed, this setting is enabled after you power off the projector and the cool-down process is complete.
Projection	Front, Front/Ceiling, Rear, Rear/Ceiling		Changes this setting depending on how the projector is installed.

Function	Menu/Settings		Explanation
Operation	Direct Power On	On, Off	Sets up the projector so that projection starts as soon as the power cord is plugged in without any button operations. Note that when this is set to On , projection starts if power is restored after a blackout or other power outage and the power cord is still plugged into the projector.
	Sleep Mode	On, Off	If the set time is exceeded and no signal is input, the projector is automatically turned off and enters standby mode. When in standby mode, press the standby button on the remote control or the control panel to start projection.
	Sleep Mode Timer	1 to 30 mins.	Sets the interval for Sleep Mode .
	Illumination	On, Off	Set this to Off if the light from the indicators on the control panel bother you when watching a movie in a dark room.
	High Altitude Mode	On, Off	Set this to On if you are using the projector above an altitude of 1500 meters.
Language	-		Selects the display language.
Reset	Yes, No		Resets all Extended settings except for Projection, High Altitude Mode, and Language .

■ Info menu

Function	Menu/Settings	Explanation
Projector Info	Lamp Hours	Displays the cumulative lamp operating time.
	Source	Displays the current input source.
	Input Signal	Displays the input signal format of the current input source.
	Resolution	Displays the resolution.
	Scan Mode	Displays the scan mode.
	Refresh Rate	Displays the refresh rate.
	3D Format	Displays the 3D format of the signal input during 3D projection (Frame Packing, Side by Side, or Top and Bottom).
	Sync Info	Displays the image signal information. This information may be needed if service is required.
	Color Depth	Displays the color depth and color difference.
	Status	This is information about errors that have occurred on the projector. This information may be needed if service is required.
	Serial Number	Displays the projector's serial number.
Version	Main	Displays the firmware version of the projector.
	Video2	

Reset menu

Function	Explanation
Reset Lamp Hours	Resets the cumulative lamp hours to 0 H. Reset when you replace the lamp.
Reset Memory	Resets all items for Memory to their default settings.
Reset All Config	Resets all items in the Configuration menu to their default settings. The following items are not reset to their defaults: Memory , Lamp Hours , and Language .

Problem Solving

Reading the Indicators



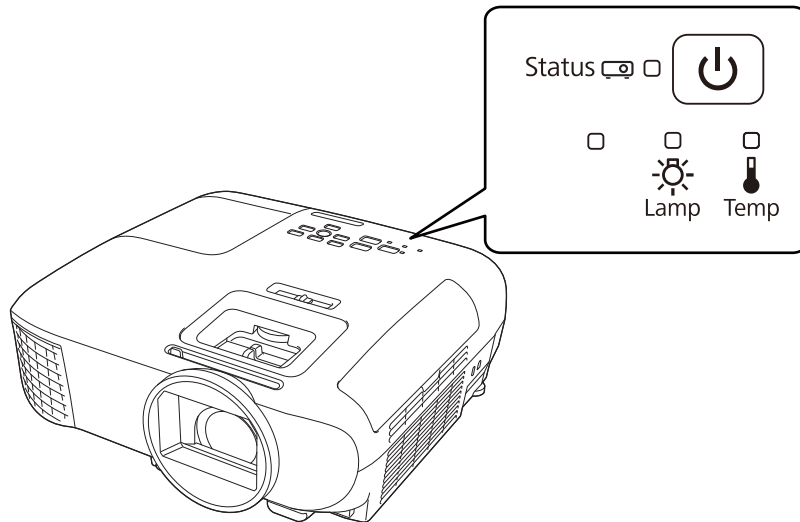



You can check the status of the projector from the flashing and lit status indicator, standby indicator, lamp indicator, and temperature indicator on the control panel.





















Refer to the following table to check the projector's status and how to remedy problems shown by the indicators.

Indicator status during an error/warning

◐ : Flashing ◑ : Lit ◒ : Status maintained ◓ : Off









Indicators	Status	Remedy
Status ◒ ◒ ◑  (blue)  ◓  (orange)	Replace Lamp	It is time to replace your lamp. Replace the lamp with a new lamp as soon as possible. p.72 The lamp may explode if you continue to use it in this status.
Status ◒ ◒ ◒ ◑  (blue) ◓   (orange)	High Temp Warning	You can continue projecting. If the temperature rises too high again, projection stops automatically. <ul style="list-style-type: none"> • If the projector is installed next to a wall, make sure there is at least 20 cm between the wall and the projector's exhaust vent. • If the air filter is clogged, clean it. p.69 • Make sure that nothing is blocking the area around the inlet and that the temperature around the inlet is not too high. p.81



Indicators	Status	Remedy
Status  (blue)  (orange)	Internal Error	The projector has malfunctioned. Remove the power plug from the electrical outlet, and contact your local dealer or the nearest Epson repair center. ➤ Epson Projector Contact List
Status  (blue)  (orange)	Fan Error Sensor Error	
Status  (blue)  (orange)	Auto Iris Error	
Status  (blue)  (orange)	Power Err. (Ballast)	
Status  (blue)  (orange)	Lamp Error Lamp Failure Lamp Cover Open	There is a problem with the lamp, or it failed to turn on. <ul style="list-style-type: none"> • Disconnect the power cord, and then check if the lamp is cracked. ➤ p.72 If it is not cracked, reinstall the lamp and turn on the power. If reinstalling the lamp does not fix the problem, or if the lamp is cracked, stop using the projector, remove the power plug from the electrical outlet, and contact your local dealer or the nearest Epson repair center. ➤ Epson Projector Contact List • Check that the lamp cover has been properly closed.

Indicators	Status	Remedy
Status    (blue)   (orange)	High Temp Error (Overheating)	The internal temperature is too high. <ul style="list-style-type: none"> • The lamp turns off automatically and projection stops. Wait for about five minutes. When the fan has stopped, disconnect the power cord. • If the projector is installed next to a wall, make sure there is at least 20 cm between the wall and the projector's exhaust vent. • If the air filter is clogged, clean it.  p.69 • Make sure that nothing is blocking the area around the inlet and that the temperature around the inlet is not too high.  p.81 • If turning the power back on does not clear the problem, stop using the projector and remove the power plug from the electrical outlet. Contact your local dealer or the nearest Epson repair center.  Epson Projector Contact List • When using at an altitude of 1500 m or more, set High Altitude Mode to On.  Extended - Operation - High Altitude Mode p.54

 Indicator status during normal operation

 : Flashing  : Lit  : Off

Indicators	Status	Remedy
Status    (blue)	Standby condition	When you press the standby button on the remote control or on the control panel, projection starts after a short wait.
Status    (blue)	Warm-up in progress	Warm-up time is about 30 seconds. The power-off operation is disabled while the projector is warming-up.
	Cool-down in progress	All operations are disabled while the projector is cooling-down. The projector enters standby condition when cool-down is complete. If for any reason the power cord is disconnected during cool-down, wait until the lamp has cooled down sufficiently (about 10 minutes), reconnect the power cord, and then press the standby button on the remote control or on the control panel.
Status    (blue)	Projection in progress	The projector is operating normally.

-  When the projector is operating normally, the temperature and lamp indicators are off.
-  When the **Illumination** function is set to **Off**, all indicators are off under normal projection conditions.  **Extended - Operation - Illumination** [p.54](#)

When the Indicators Provide No Help

■ Check the problem



Check the following table to see if your problem is mentioned, and go to the appropriate page for information on handling the problem.

	Problem	Page
Problems relating to images	No images appear	p.61
	Projection does not start, the projection area is completely black, or the projection area is completely blue.	
	Moving images are not displayed	p.61
	" Not supported " is displayed	p.61
	" No Signal " is displayed	p.62
	Keystone distortion of projected image	p.62
	Images are fuzzy or out of focus	p.62
	Interference/distortion appear in images	p.62
	The image is truncated (large) or small, or only a part of the image is projected.	p.63
	Image colors are not right	p.63
	The whole image appears purplish or greenish, images are black & white, or colors appear dull.*	
	Images appear dark	p.63
	Projection stops automatically	p.64
Noise problems	No audio, or the audio is too low	p.64
Problems when projection starts	The projector does not turn on	p.64
Problems with the remote control	The remote control does not respond	p.65
Problems with the control panel	Cannot operate on the control panel	p.65
Problems with 3D	Cannot project correctly in 3D	p.65
Problems with HDMI	HDMI Link does not function	p.66
	The device name is not displayed under Device Connections	p.67
Bluetooth device problems	Cannot Connect Bluetooth Device	p.67
	The audio and connection for the Bluetooth device disconnects	p.67
Problems with a streaming media player	Cannot view images from a streaming media player	p.67

* Because color reproduction differs between monitors and computer LCD screens, the image projected by the projector and the color tones displayed on the monitor may not match, however this is not a fault.

■ Problems relating to images



No images appear

Check	Remedy
Is the power turned on?	Press the standby button on the remote control or the control panel.
Is the power cord connected?	Connect the power cord.
Are the indicators switched off?	Disconnect and then reconnect the projector's power cord. Check that pressing the standby button after connection supplies the projector with power.
Is an image signal being input?	Check that the connected device is turned on. When Messages is set to On from the Configuration menu, image signal messages are displayed.  Extended - Display - Messages p.54
Has the power to the AV amplifier been disconnected?	If an AV amplifier is connected, check the AV amplifier's power supply.
Is an image signal being sent from the device?	Check that an image signal is being sent from the connected device.
Are the Configuration menu settings correct?	Reset all of the settings.  Reset - Reset All Config p.56
(Only when projecting computer image signals) Was the connection made while the power of the projector or the computer was already turned on?	If the connection is made while the power is already turned on, the Fn key (Function key) that changes the computer's image signal to external output may not work. Turn off the power for the computer and the projector and then turn it back on again.



Moving images are not displayed

Check	Remedy
(Only when projecting computer image signals) Is the computer's image signal set to external output and to output to the LCD monitor at the same time?	Depending on the computer's specifications, moving images may not be displayed when the computer is set to external output and to the LCD monitor output at the same time. Change it so that the image signal is set to external output only. For the computer's specifications, see the documentation supplied with the computer.

"Not supported" is displayed

Check	Remedy
(Only when projecting computer image signals) Do the image signal's frequency and resolution correspond to the mode?	Check the image signal being input in Resolution from the Configuration menu, and check that it matches the projector's resolution.  Info - Projector Info p.55  "Supported Resolutions" p.78



"No Signal" is displayed

Check	Remedy
Are the cables connected correctly?	Check that all the cables required for projection are securely connected.  p.20
Is the correct image input port selected?	Press the source button on the remote control or the [Home]/[HDMI] button on the control panel to switch between input images.  p.26
Is the connected device turned on?	Turn on the device.
(Only when projecting computer image signals) Are the image signals being output to the projector?	Change it so that the image signal is set to external output, and not just the computer's LCD monitor. For some models, when the image signals are output externally, they no longer appear on the LCD monitor. For the computer's specifications, see the documentation supplied with the computer. If the connection is made while the power of the projector or the computer is already turned on, the Fn key (Function key) that changes the computer's image signal to external output may not work. Turn off the power for the computer and the projector and then back on again.

Keystone distortion of projected image

Check	Remedy
Is keystone distortion adjusted within the correction range?	If projecting the image from outside of the correctable range, you may not be able to correct the keystone distortion completely. Install the projector horizontally in front of the screen and parallel to the screen as much as possible, and then adjust the projection position using lens shift.  p.14

Images are fuzzy or out of focus

Check	Remedy
Has the focus been adjusted?	Adjust the focus.  p.27
Is the lens cover closed?	Open the lens cover.
Is the projector at the correct distance?	Check the recommended projection range.  p.17
Has condensation formed on the lens?	If the projector is suddenly taken from a cold environment to a warm environment, or if sudden ambient temperature changes occur, condensation may form on the surface of the lens, and this may cause the images to appear fuzzy. Set the projector up in the room about one hour before it is used. If the projector is wet from condensation, turn off the projector, disconnect the power cord, and leave it for a while.

Interference or distortion appear in images

Check	Remedy
Are the cables connected correctly?	Check that all the cables required for projection are securely connected.  p.20

Check	Remedy
Is an extension cable being used?	If an extension cable is used, electrical interference may affect the signals.
(Only when projecting computer image signals) Is the correct resolution selected?	Set the computer so that the signals being output are compatible with the projector. 🖱️ p.78

Part of the image is truncated (large) or small

Check	Remedy
Is the correct Aspect selected?	Select the aspect mode to match the input signal in Aspect from the Configuration menu. 🖱️ Signal - Aspect p.51
(Only when projecting computer image signals) Is the correct resolution selected?	Set the computer so that the signals being output are compatible with the projector. 🖱️ p.78

Image colors are not right

Check	Remedy
Are the cables connected correctly?	Check that all the cables required for projection are securely connected. 🖱️ p.20
Is the contrast adjusted correctly?	Adjust the Contrast setting from the Configuration menu. 🖱️ Image - Contrast p.50
Is the color adjusted correctly?	Adjust the Advanced setting from the Configuration menu. 🖱️ Image - Advanced p.50
(Only when projecting images from a video device) Are the color saturation and tint adjusted correctly?	Adjust the Color Saturation and Tint settings from the Configuration menu. 🖱️ Image - Color Saturation/Tint p.50

Images appear dark



Check	Remedy
Is the image brightness set correctly?	Adjust the Brightness setting from the Configuration menu. 🖱️ Image - Brightness p.50
Is the contrast adjusted correctly?	Adjust the Contrast setting from the Configuration menu. 🖱️ Image - Contrast p.50
Is it time to replace the lamp?	When the lamp is nearly ready for replacement, the images become darker and the color quality becomes poorer. When this happens, replace the lamp with a new lamp. 🖱️ p.72

Projection stops automatically

Check	Remedy
Is Sleep Mode enabled?	If the set time is exceeded and no signal is input, the lamp is automatically turned off and the projector enters standby mode. Press the standby button on the remote control or on the control panel to turn on the projector. If you want to disable Sleep Mode , change the setting to Off .  Extended - Operation - Sleep Mode p.54



 Noise problems

No audio, or the audio is too low

Check	Remedy
Is the audio cable connected correctly?	Try disconnecting the cable from the Audio Out port, and then reconnecting.
Is the volume too low?	Adjust the volume so that you can hear the audio.  p.32
Is it connected with an HDMI cable?	If no audio is output when connecting via an HDMI cable, set the connected equipment to PCM output.
Are the Audio Out Device settings correct?	Check that the Audio Out Device settings are correct on the Configuration menu.  Settings - HDMI Link - Audio Out Device p.52
Are the Bluetooth Audio settings correct?	Make the following settings when connecting a Bluetooth audio device. <ul style="list-style-type: none"> • To output audio from the projector's speaker or an amplifier, set Bluetooth Audio to Off. • To output audio from Bluetooth audio devices, set Bluetooth Audio to On.  Settings - Bluetooth - Bluetooth Audio p.52

 Problems when projection starts





The projector does not turn on

Check	Remedy
Is the power turned on?	Press the standby button on the remote control or the control panel.
Is Child Lock set to On ?	When Child Lock is set to On from the Configuration menu, hold down the standby button on the control panel for approximately three seconds, or perform operations from the remote control.  Settings - Lock Setting - Child Lock p.52
Do the indicators turn on and off when the power cord is touched?	Turn off the projector, and then disconnect and reconnect the projector's power cord. If the problem continues, stop using the projector, remove the power plug from the electrical outlet, and contact your local dealer or the nearest projector information center.  Epson Projector Contact List

Check	Remedy
Are the lamp cover and lamps installed correctly?	If the lamp or lamp cover is installed incorrectly, the projector cannot be turned on. Check how it is installed.  p.72

 Problems with the remote control

The remote control does not respond

Check	Remedy
Is the remote control light-emitting area pointing towards the remote receiver on the projector during operation?	Point the remote control towards the remote receiver. Also, check the operating range.  p.24
Is the remote control too far from the projector?	Check the operating range.  p.24
Is direct sunlight or strong light from fluorescent lamps shining onto the remote receiver?	Set the projector up in a location where strong light does not shine onto the remote receiver.
Are the batteries dead or have the batteries been inserted correctly?	Make sure the batteries are inserted correctly or replace the batteries with new ones if necessary.  p.23
Has the streaming media player been paired?	<ul style="list-style-type: none"> • When the pairing screen is displayed, hold down the [Enter] button and the home button on the remote control at the same time for approximately three seconds to pair the devices.  p.23 • If the pairing screen is not displayed, make sure that the projector and the streaming media player are on, and then hold down the Esc button and the right button on the remote control for approximately seven seconds. This should display the pairing screen and allow you to perform pairing.  p.23
Are you using the remote control for Android TV™ to perform operations?	Check that you are not using the remote control for Android TV™. Use the projector remote control.

 Problems with the control panel



Cannot operate on the control panel

Check	Remedy
Is Control Panel Lock set to Full Lock or Partial Lock ?	When Control Panel Lock is set to Full Lock in the Configuration menu, all button operations on the control panel are disabled; when Partial Lock is set, only the standby button on the control panel is available. Perform operations from the remote control.  Settings - Lock Setting - Control Panel Lock p.52

 Problems with 3D



Cannot project correctly in 3D

Check	Remedy
Are the 3D Glasses turned on?	Turn on the 3D Glasses.
Are the 3D Glasses fully charged?	Charge the 3D Glasses.

Check	Remedy
Is a 3D image being projected?	If the projector is projecting a 2D image, or if an error occurs on the projector that prevents the 3D image from being projected, you cannot view 3D images even if you are wearing the 3D Glasses.
Is the input image in 3D?	Check that the input image is 3D compatible. Since most TV broadcasts do not contain a 3D format signal, 3D reception must be set manually.
Is 3D Display set to 2D ?	If 3D Display is set to 2D from the Configuration menu, the projector does not automatically change to 3D even when a 3D image is input. Set 3D Display to either 3D or Auto .  Signal - 3D Setup - 3D Display p.51
Is 3D Format set correctly?	Unless the 3D format of the AV device and 3D Format of the projector are the same, part of the image may not be displayed. Check that the projector's 3D Format setting matches the 3D format setting for the AV device.  Signal - 3D Setup - 3D Format p.51 When changing the 3D Format , set 3D Display to 3D , and then press the [3D Format] button.
Are you viewing within the reception range?	If the distance between the projector and the 3D Glasses exceed 10 m, the connection may be lost. Move the 3D Glasses closer to the projector.
Has pairing been performed correctly?	See the user's guide supplied with your 3D Glasses and perform pairing.
Are there any devices that cause radio wave interference in the vicinity?	When using other devices at the same time with the frequency band (2.4 GHz) such as Bluetooth communication devices, wireless LAN (IEEE802.11b/g), or microwave ovens, radio wave interference may occur, the image may be interrupted, or communication may not be possible. Do not use the projector near these devices.

Problems with HDMI

HDMI Link does not function

Check	Remedy
Are you using a cable that meets the HDMI standards?	Operations are not possible with cables that do not meet the HDMI standards.
Does the connected device meet the HDMI CEC standards?	If the connected device does not meet the HDMI CEC standards, it cannot be operated even if it is connected to the HDMI port. See the documentation and so on supplied with the connected device for more information. Also, check if the device is available under Device Connections .  p.48
Are the cables connected correctly?	Check that all the cables required to use HDMI Link are securely connected.  p.47
Is the power for the amplifier or DVD recorder and so on turned on?	Put each device in standby status. See the documentation and so on supplied with the connected device for more information. If you have connected a speaker and so on, set the connected equipment to PCM output.

Check	Remedy
Was a new device connected, or was the connection changed?	If the CEC function for a connected device needs to be set again, for example when a new device is connected or the connection is changed, you may need to restart the device.
Are many multi-media players connected?	Up to 1 multi-media player that meets the HDMI CEC standards can be connected at the same time.

The device name is not displayed under Device Connections

Check	Remedy
Does the connected device meet the HDMI CEC standards?	If the connected device does not meet the HDMI CEC standards, it is not displayed. See the documentation and so on supplied with the connected device for more information.

Bluetooth device problems

Cannot Connect Bluetooth Device

Check	Remedy
Was a device search performed?	When connecting a Bluetooth device for the first time, or when changing to another Bluetooth device, perform Search Bluetooth Device.  p.20
Does the device support copyright protection (SCMS-T)?	You cannot connect a Bluetooth device that does not support copyright protection (SCMS-T).
Is the device based on A2DP?	You cannot connect a Bluetooth device that does not support A2DP.

The audio and connection for the Bluetooth device disconnects

Check	Remedy
Are there any obstacles between the projector and the Bluetooth device?	Check for any obstacles between the projector and the Bluetooth device, and change their positions to improve communication.
Is the device connected within the specified communication distance?	If the distance between the projector and the Bluetooth device exceed 10 m, the connection may be lost. Move the Bluetooth device closer to the projector.
Are there any wireless equipment or microwave ovens in the vicinity?	If the device is used at the same time as other wireless equipment or microwave ovens, radio wave interference may occur, and the image and audio may be interrupted. Avoid equipment that could cause interference.

Problems with a streaming media player

Cannot view images from a streaming media player

Check	Remedy
Is the device connected to the Internet?	You need an Internet connection to view online content. Make sure you can connect to Wi-Fi.

Check	Remedy
Can you perform screen operations using the remote control or the control panel?	If you cannot perform operations, restart the projector.

Maintenance

Cleaning the Parts

You should clean the projector if it becomes dirty or if the quality of projected images starts to deteriorate.

Warning

- Do not use sprays that contain flammable gas to remove dirt and dust from the projector's lens, air filter, and so on. The projector may catch fire due to the high internal temperature of the lamp.
- Do not use the projector in locations where flammable or explosive gases such as those used in air dusters or insecticides may be present in the atmosphere.
The lamp inside the projector is hot.
Combustible components contained in air dusters, insecticides, deodorants, and so on could be sucked into the projector and ignite causing fire and burns to occur. If flammable sprays have been used around the projector, be sure to ventilate the area thoroughly before turning on the projector.

Cleaning the air filter

Clean the air filter if dust has accumulated on the air filter or when the following message is displayed. **"The projector is overheating. Make sure nothing is blocking the air vent, and clean or replace the air filter."**

Attention

- If dust collects on the air filter, it can cause the internal temperature of the projector to rise, and this can lead to problems with operation and shorten the optical engine's service life. It is recommended that you clean the air filter at least once every three months. Clean them more often than this if using the projector in a particularly dusty environment.
- Do not rinse the air filter in water. Do not use detergents or solvents.
- Do not use an air duster. Combustible material may remain, and dust may enter the precision parts.

For EH-TW5700 (ELPAF54)

1 Press the standby button on the remote control or the control panel to turn off the power, and then disconnect the power cord.

2 Remove any dust on the air filter by using a vacuum cleaner from the front side.

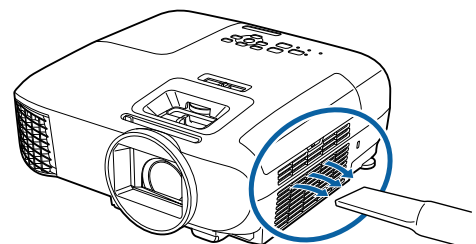

For EH-TW5800 (ELPAF55)

1 Press the standby button on the remote control or the control panel to turn off the power, and then disconnect the power cord.

2 Open the air filter cover.

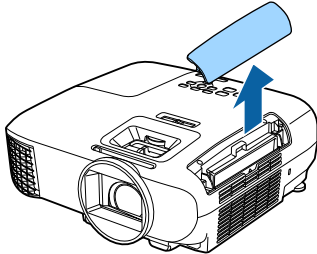

3 Remove the air filter.
Grip the air filter cover tab and pull it straight up.

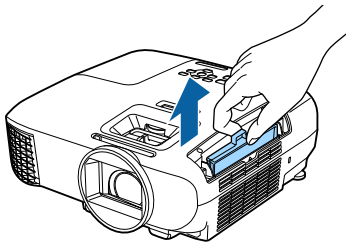

4 Hold the air filter with the surface facing down and tap it 4 or 5 times to remove the dust.
Tap the air filter on its side to remove the dust.

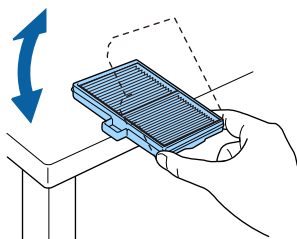

Attention

If the air filter is hit too hard, it may become unusable due to deformities and cracks.

5 Remove any dust remaining on the air filter by using a vacuum cleaner from the front side.

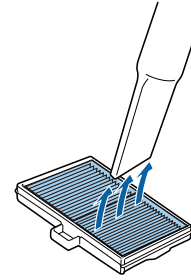

6 Install the air filter.
Slide in the air filter until it clicks into place.

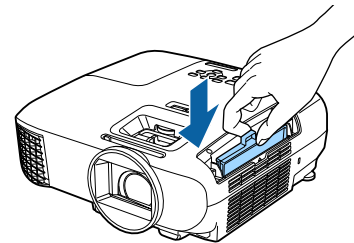

7 Close the air filter cover.

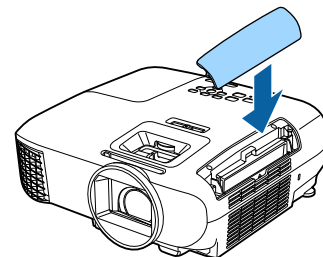

■ Cleaning the main unit

Before cleaning, make sure you unplug the power cord from the outlet.
Clean the projector's surface by wiping it gently with a soft cloth.

If it is particularly dirty, use a piece of well-wrung cloth moistened with water and wipe the surface again with a dry cloth.

Attention

Do not use detergent for kitchen or volatile substances such as wax, benzine and thinner to clean the projector's surface. The quality of the outer case may change or the paint may peel off.

■ Cleaning the lens

Before cleaning, make sure you unplug the power cord from the outlet.

Use a commercially available cloth for cleaning glasses to gently wipe off dirt from the lens.

Attention

- Do not rub the lens with harsh materials or handle the lens too roughly as it can easily become damaged.
- Do not use an air duster. Combustible material may remain, and dust may enter the precision parts.

Replacement Periods for Consumables

■ Air filter replacement period

If the replacement message is displayed even though the air filter has been cleaned  [p.69](#)

■ Lamp replacement period

- When the following message is displayed when projection starts:
It is time to replace your lamp. Please contact your Epson projector reseller or visit www.epson.com to purchase."
- When the projected image gets darker or starts to deteriorate.
- When the lamp replacement message is displayed. The message is displayed when the lamp usage reaches 100 hours before its life expectancy, and disappears after 30 seconds.



- The brightness of the projected image declines with the passage of projection time. The lamp replacement message is displayed to help you maintain the brightness and image quality of the initial image. The message display time differs depending on the menu settings, the environmental conditions, and the usage conditions.
If you continue to use the lamp after the replacement period has passed, the possibility that the lamp may explode increases. When the lamp replacement message is displayed, replace the lamp with a new one as soon as possible, even if it is still working.
- Depending on the characteristics of the lamp and the way it has been used, the lamp may become darker or stop working before the lamp warning message appears. You should always have a spare lamp unit ready in case it is needed.

Replacing Consumables

■ Replacing the air filter



Dispose of used air filters properly in accordance with your local regulations.

Filter frame: ABS (ELPAF54)/Polypropylene (ELPAF55)

Filter: Polyurethane foam (ELPAF54)/Polypropylene (ELPAF55)

- 1 Press the standby button on the remote control or the control panel to turn off the power, and then disconnect the power cord.

- 2 Open the air filter cover.

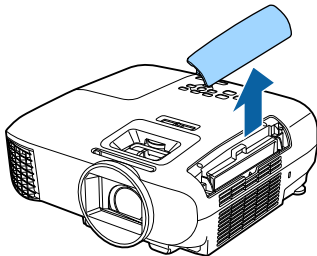

- 3 Remove the old air filter.
Grip the air filter cover tab and pull it straight up.

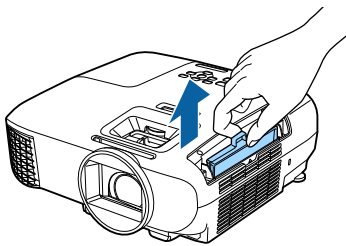

- 4 Install the new air filter.
Slide in the air filter until it clicks into place.

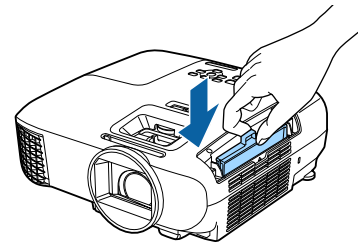

- 5 Close the air filter cover.

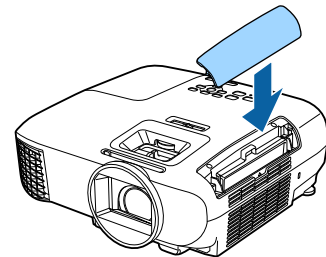

■ Replacing the lamp



Warning

When replacing the lamp because it has stopped illuminating, there is a possibility that the lamp may be broken. If replacing the lamp of a projector that has been suspended from the ceiling, you should always assume that the lamp is cracked, and remove the lamp cover with care. When you open the lamp cover, small shards of glass could fall out. If any shards of glass get into your eyes or mouth, contact a doctor immediately.

⚠ Caution

- Do not touch the lamp cover immediately after turning off the projector as it is still hot. Wait until the lamp has cooled down sufficiently before removing the lamp cover. Otherwise, you could get burnt.
- We recommend the use of genuine EPSON option lamps. The use of non-genuine lamps may affect projection quality and safety.
Any damage or malfunction caused by the use of non-genuine lamps may not be covered by Epson's warranty.

1 Press the standby button on the remote control or the control panel to turn off the power, and then disconnect the power cord.

2 Loosen the lamp cover fixing screw.

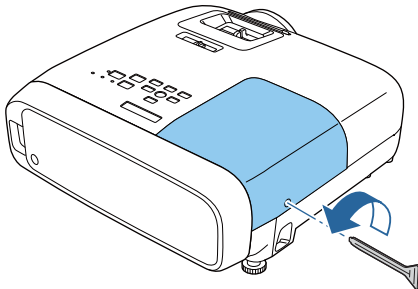

3 Remove the lamp cover.
Slide the lamp cover straight and remove it.

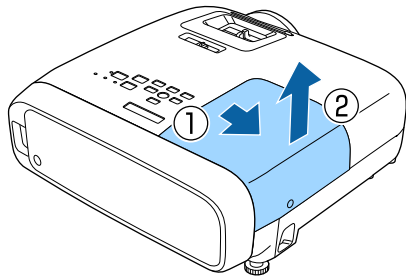

4 Loosen the two lamp fixing screws.

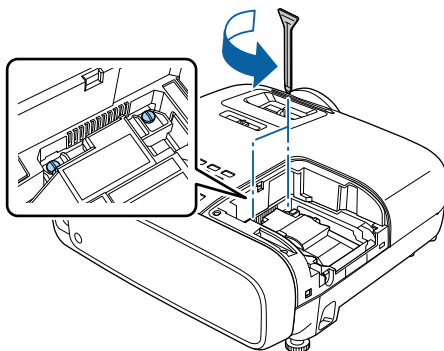

5 Remove the old lamp.
Grip the projection and pull it straight out.

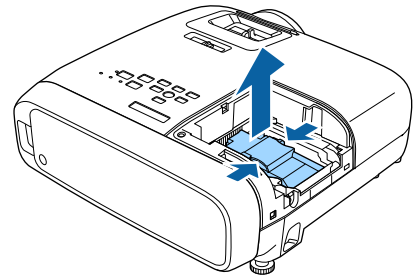

6 Install the new lamp.
Make sure the lamp is facing the correct direction and press it in.

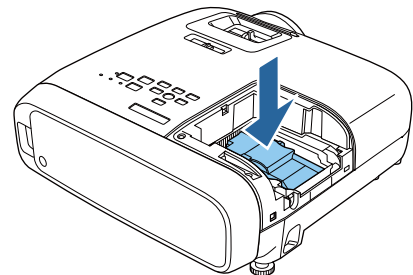

7 Tighten the two lamp fixing screws.

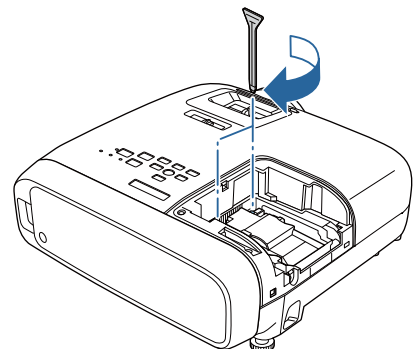

- 8 Replace the lamp cover.
Slide the cover back into place.

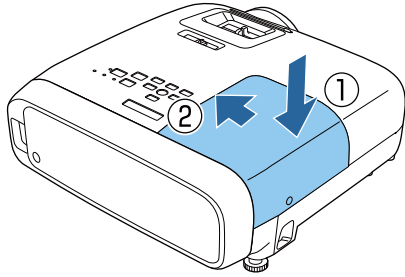

- 9 Tighten the lamp cover fixing screw.

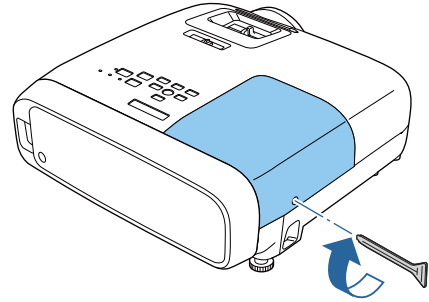

Warning

Do not disassemble or remodel the lamp. If a modified or disassembled lamp is installed in the projector and used, it could cause a fire, electric shock, or an accident.

Caution

- Make sure you install the lamp and lamp cover securely. If they are not installed correctly, the power does not turn on.
- The lamp contains mercury (Hg). Dispose of used lamps in accordance with your local laws and regulations. When using in a company, observe your companies rules and regulations.

Resetting lamp hours

After replacing the lamp, make sure you reset the lamp hours.

The projector records how long the lamp is turned on and a message and indicator notify you when it is time to replace the lamp.

- 1 Turn on the power.

- 2 Press the [Menu] button.

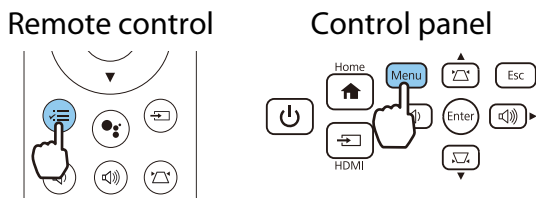

The Configuration menu is displayed.

- 3 Select **Reset - Reset Lamp Hours**.
A reset confirmation message is displayed.



4

Use the left and right buttons to select **Yes**, and then press the [Enter] button to execute.

The lamp hours are reset.

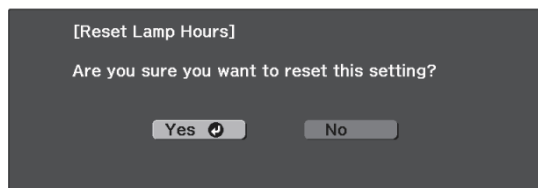

Disconnecting a Streaming Media Player

1 Remove the cover.

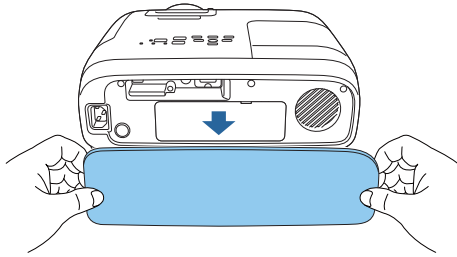

2 Remove the storage space cover.

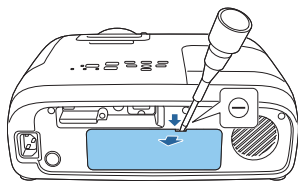

3 Pull out the streaming media player, and disconnect the USB power cable.

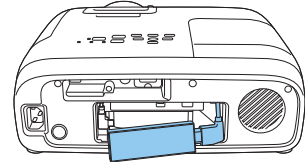

4 Disconnect the HDMI cable.

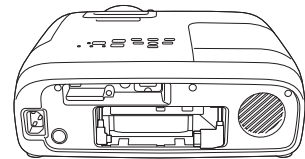

Attention

- When using the projector, make sure you connect the built-in streaming media player.
- The built-in streaming media player is dedicated to this projector. Depending on the video equipment you are connecting, it may not work correctly.



If the built-in streaming media player is sent for repairs, it may be reset when it is returned. Make sure you save any account information for your online services before sending it for repairs.

Optional Accessories and Consumables

The following optional accessories and consumables are available for purchase if required. This list of optional accessories and consumables is current as of February 2020. Details of accessories are subject to change without notice.

Varies depending on country of purchase.

Optional Items

Name	Model No.	Explanation
Ceiling mount (white)*	ELPMB23	Use when installing the projector on a ceiling.
Safety wire attachment	ELPWR01	Connects the projector to the ceiling mount to prevent it from falling.
Ceiling pipe 450 (450 mm white)*	ELPFP13	Use when installing the projector on a high ceiling.
Ceiling pipe 700 (700 mm white)*	ELPFP14	
Computer cable (1.8 m)	ELPKC02	Use when projecting a computer's screen.
Computer cable (3.0 m)	ELPKC09	
Computer cable (20.0 m)	ELPKC10	

* Special expertise is required to suspend the projector from a ceiling. Contact your local dealer.

Consumables

Name	Model No.	Explanation
Lamp unit	ELPLP97	Use as a replacement for used lamps. (1 lamp)
Air filter	ELPAF54 (for EH-TW5700) ELPAF55 (for EH-TW5800)	Use as a replacement for used air filters. (Contains 2 air filters)



Supported Resolutions

If the projector receives higher resolution signals than the resolution of the projector panel, the image quality may be degraded.

The projector supports signals marked with a check symbol.

PC

Signal Format	Resolution (Dot)		V Sync (Hz)	Dotclk (MHz)	HDMI								
					RGB		YCbCr						
							4:4:4		4:2:2		4:2:0		
					8	10, 12	8	10, 12	8	10, 12	8	10, 12	
VGA60	640	480	60	25.175	✓								
UWHD	2560	1080	60	198.000	✓								

SD

Signal Format	Resolution (Dot)		V Sync (Hz)	Dotclk (MHz)	HDMI								
					RGB		YCbCr						
							4:4:4		4:2:2		4:2:0		
					8	10, 12	8	10, 12	8	10, 12	8	10, 12	
SDTV (480i)	720	480	59.94	13.500	✓	✓	✓	✓	✓	✓			
SDTV (576i)	720	576	50	13.500	✓	✓	✓	✓	✓	✓			
SDTV (480p)	720	480	59.94	27.000	✓	✓	✓	✓	✓	✓			
SDTV (576p)	720	576	50	27.000	✓	✓	✓	✓	✓	✓			

HD

Signal Format	Resolution (Dot)		V Sync (Hz)	Dotclk (MHz)	HDMI								
					RGB		YCbCr						
							4:4:4		4:2:2		4:2:0		
					8	10, 12	8	10, 12	8	10, 12	8	10, 12	
HDTV (720p)	1280	720	50	74.250	✓	✓	✓	✓	✓	✓			
HDTV (720p)	1280	720	59.94	74.176	✓	✓	✓	✓	✓	✓			
HDTV (720p)	1280	720	60	74.250	✓	✓	✓	✓	✓	✓			
HDTV (1080i)	1920	1080	50	74.250	✓	✓	✓	✓	✓	✓			
HDTV (1080i)	1920	1080	59.94	74.176	✓	✓	✓	✓	✓	✓			
HDTV (1080i)	1920	1080	60	74.250	✓	✓	✓	✓	✓	✓			
HDTV (1080p)	1920	1080	23.98	74.176	✓	✓	✓	✓	✓	✓			

Signal Format	Resolution (Dot)		V Sync (Hz)	Dotclk (MHz)	HDMI							
					RGB		YCbCr					
							4:4:4		4:2:2		4:2:0	
					8	10, 12	8	10, 12	8	10, 12	8	10, 12
HDTV (1080p)	1920	1080	24	74.250	✓	✓	✓	✓	✓	✓		
HDTV (1080p)	1920	1080	29.97	74.176	✓	✓	✓	✓	✓	✓		
HDTV (1080p)	1920	1080	30	74.250	✓	✓	✓	✓	✓	✓		
HDTV (1080p)	1920	1080	50	148.500	✓	✓	✓	✓	✓	✓		
HDTV (1080p)	1920	1080	59.94	148.352	✓	✓	✓	✓	✓	✓		
HDTV (1080p)	1920	1080	60	148.500	✓	✓	✓	✓	✓	✓		

3D

Signal Format	Resolution (Dot)		V Sync (Hz)	Dotclk (MHz)	3D Format	HDMI						
						RGB		YCbCr				
								4:4:4		4:2:2		
						8	10, 12	8	10, 12	8	10, 12	
HDTV (720p)	1280	720	60	148.500	Frame Packing	✓	✓	✓	✓	✓	✓	
					74.250	Side by Side	✓	✓	✓	✓	✓	✓
					74.250	Top and Bottom	✓	✓	✓	✓	✓	✓
HDTV (720p)	1280	720	59.94	148.500	Frame Packing	✓	✓	✓	✓	✓	✓	
					74.250	Side by Side	✓	✓	✓	✓	✓	✓
					74.250	Top and Bottom	✓	✓	✓	✓	✓	✓
HDTV (720p)	1280	720	50	148.500	Frame Packing	✓	✓	✓	✓	✓	✓	
					74.250	Side by Side	✓	✓	✓	✓	✓	✓
					74.250	Top and Bottom	✓	✓	✓	✓	✓	✓
HDTV (1080i)	1920	1080	60	148.500	Frame Packing							
					74.250	Side by Side	✓	✓	✓	✓	✓	✓
					74.250	Top and Bottom						
HDTV (1080i)	1920	1080	59.94	148.500	Frame Packing							
					74.250	Side by Side	✓	✓	✓	✓	✓	✓
					74.250	Top and Bottom						

Signal Format	Resolution (Dot)		V Sync (Hz)	Dotclk (MHz)	3D Format	HDMI						
						RGB		YCbCr				
								4:4:4		4:2:2		
						8	10, 12	8	10, 12	8	10, 12	
HDTV (1080i)	1920	1080	50	148.500	Frame Packing							
					74.250	Side by Side	✓	✓	✓	✓	✓	✓
					74.250	Top and Bottom						
HDTV (1080p)	1920	1080	24	148.500	Frame Packing	✓	✓	✓	✓	✓	✓	
					74.250	Side by Side	✓	✓	✓	✓	✓	✓
					74.250	Top and Bottom	✓	✓	✓	✓	✓	✓
HDTV (1080p)	1920	1080	23.98	148.500	Frame Packing	✓	✓	✓	✓	✓	✓	
					74.250	Side by Side	✓	✓	✓	✓	✓	✓
					74.250	Top and Bottom	✓	✓	✓	✓	✓	✓
HDTV (1080p)	1920	1080	60	297.000	Frame Packing							
					148.500	Side by Side	✓	✓	✓	✓	✓	✓
					148.500	Top and Bottom						
HDTV (1080p)	1920	1080	59.94	297.000	Frame Packing							
					148.500	Side by Side	✓	✓	✓	✓	✓	✓
					148.500	Top and Bottom						
HDTV (1080p)	1920	1080	50	297.000	Frame Packing							
					148.500	Side by Side	✓	✓	✓	✓	✓	✓
					148.500	Top and Bottom						



Specifications

EH-TW5800/EH-TW5700

Product name		EH-TW5800	EH-TW5700
Appearance		309 (W) x 107 (H) x 308 (D) mm (not including adjustable foot)	
Panel size		0.61" wide	
Display method		Polysilicon TFT active matrix	
Resolution		1920 (W) x 1080 (H) x 3	
Focus adjustment		Manual	
Zoom adjustment		Manual (Approx. 1 to 1.6)	Manual (Approx. 1 to 1.2)
Lamp (light source)		UHE lamp 200 W	
Lamp life expectancy		When Power Consumption is set to High from the Image menu: approx. 4,500 hours When Power Consumption is set to ECO from the Image menu: approx. 7,500 hours	
Power supply		100 - 240 V AC±10%, 50/60 Hz, 3.2 - 1.4 A	
Power consumption	100 to 120 V area	Rated power consumption: 310 W	
		Power consumption when standing by: 0.3 W	
	220 to 240 V area	Rated power consumption: 297 W	
		Power consumption when standing by: 0.3 W	
Operating altitude		Altitude 0 to 3048 m	
Operating temperature		+5 to +35°C (No condensation) (at an altitude of 0 to 2286 m) +5 to +30°C (No condensation) (at an altitude of 2287 to 3048 m)	
Storage temperature		-10 to +60°C (No condensation)	
Mass		Approx. 3.8 kg	Approx. 3.6 kg
Speaker		10 W x 1 (enclosure)	
Connectors	HDMI port	1	HDMI HDCP1.4 supported, CEC signals supported, 3D signals supported, Linear PCM supported, Deep Color
	Audio Out port	1	Stereo mini jack (3.5Φ)
	Service port*	1	USB connector (Type B)

* Supports USB 2.0. However, USB ports are not guaranteed to operate all devices that support USB.

This product is also designed for IT power distribution system with phase-to-phase voltage 230V.

Angle of tilt

If you use the projector tilted at an angle of more than 10°, the projector could be damaged or it may lead to an accident.

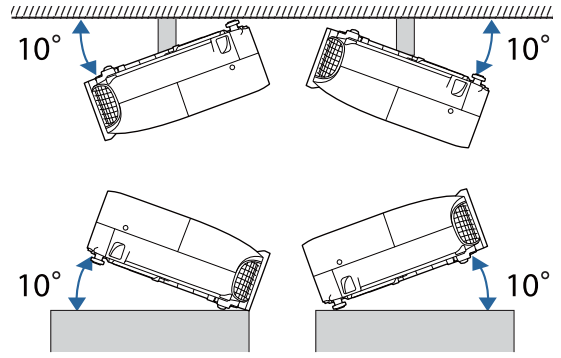



Appearance

Units: mm

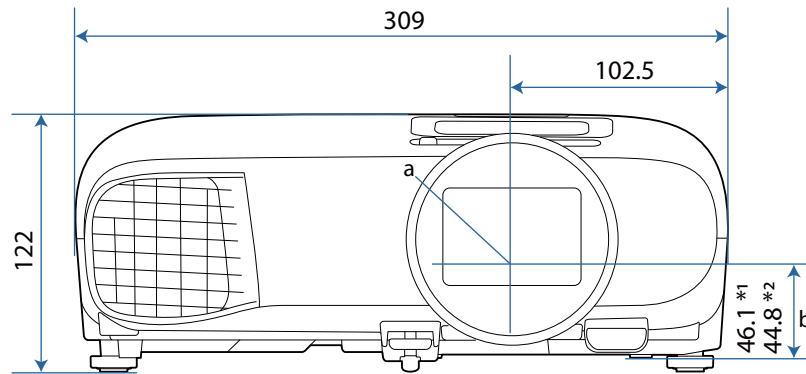





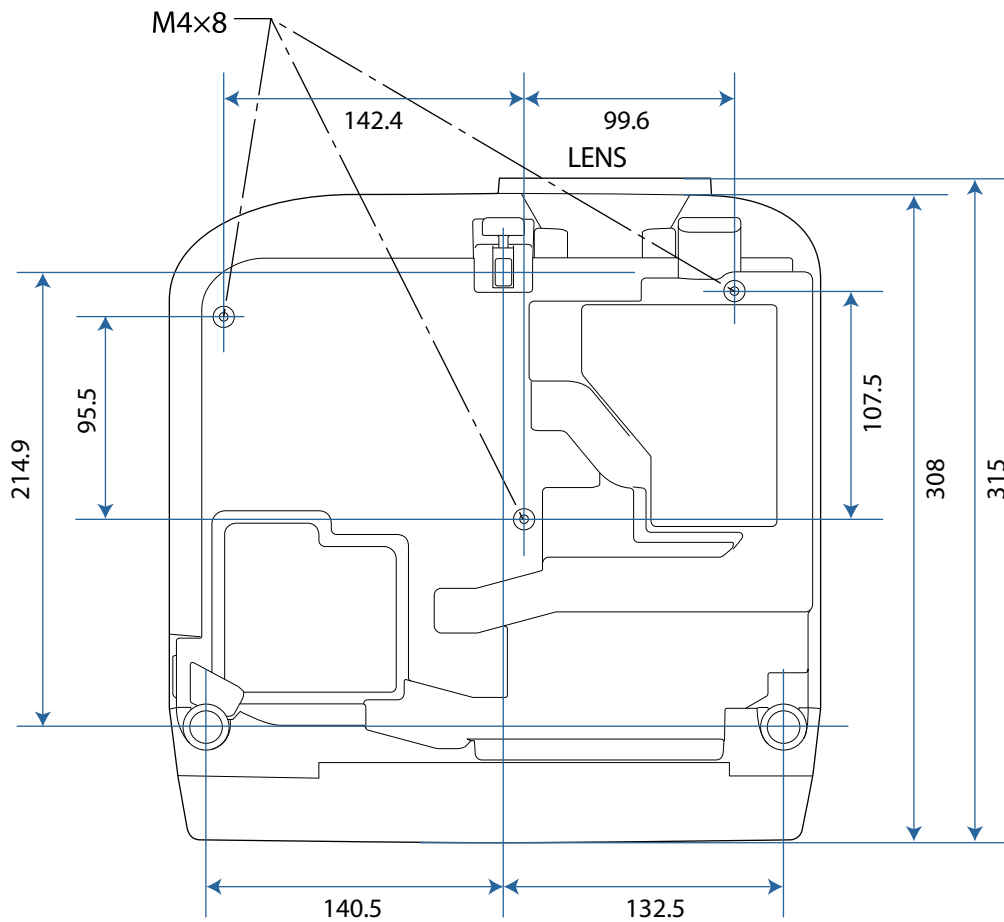









*1: EH-TW5800
*2: EH-TW5700

















- a Center of lens
- b Distance from center of lens to suspension bracket fixing point



List of Safety Symbols

The following table lists the meaning of the safety symbols labeled on the equipment.

Symbol mark	Approved standards	Meaning
	IEC60417 No.5007	"ON" (power) To indicate connection to the mains.
	IEC60417 No.5008	"OFF" (power) To indicate disconnection from the mains.
	IEC60417 No.5009	Standby To identify the switch or switch position by means of which part of the equipment is switched on in order to bring it into the standby condition.
	ISO7000 No.0434B IEC3864-B3.1	Caution To identify general caution when using the product.
	IEC60417 No.5041	Caution, hot surface To indicate that the marked item can be hot and should not be touched without taking care.
	IEC60417 No.6042 ISO3864-B3.6	Caution, risk of electric shock To identify equipment that has risk of electric shock.
	IEC60417 No.5957	For indoor use only To identify electrical equipment designed primarily for indoor use.
	IEC60417 No.5926	Polarity of d.c. power connector To identify the positive and negative connections (the polarity) on a piece of equipment to which a d.c. power supply may be connected.
	---	
	IEC60417 No.5001B	Battery, general On battery powered equipment. To identify a cover for the battery compartment, or the connector terminals.
	IEC60417 No.5002	Positioning of cell To identify the battery holder itself and to identify the positioning of the cell(s) inside the battery holder.
	---	
	IEC60417 No.5019	Protective earth To identify any terminal which is intended for connection to an external conductor for protection against electric shock in case of a fault, or the terminal of a protective earth electrode.
	IEC60417 No.5017	Earth To identify an earth (ground) terminal in cases where neither the symbol  is explicitly required.

Symbol mark	Approved standards	Meaning
	IEC60417 No.5032	Alternating current To indicate on the rating plate that the equipment is suitable for alternating current only; to identify relevant terminals.
	IEC60417 No.5031	Direct current To indicate on the rating plate that the equipment is suitable for direct current only; to identify relevant terminals.
	IEC60417 No.5172	Class II equipment To identify equipment meeting the safety requirements specified for Class II equipment according to IEC 61140.
	ISO 3864	General prohibition To identify actions or operations that are prohibited.
	ISO 3864	Contact prohibition To indicate injury that could occur due to touching a specific part of the equipment.
	---	Never look into the projection lens while the projector is on.
	---	To indicate that you must never place anything on the projector.
	ISO3864 IEC60825-1	Caution, laser radiation To indicate the equipment has a laser radiation part.
	ISO 3864	Disassembly prohibition To indicate a risk of injury, such as electric shock, if the equipment is disassembled.
	IEC60417 No.5266	Standby, partial standby To indicate that part of the equipment is in the ready status.
	ISO3864 IEC60417 No.5057	Caution, movable parts To indicate that you must keep away from movable parts according to protection standards.
	IEC 60417-6056	Caution (movable fan blades) To indicate that you must keep away from the blades of the movable fan according to protection standards.
	IEC 60417-6043	Caution (sharp corners) To indicate that you must not touch the sharp corners of the product according to protection standards.
	--	Never look into the projection lens while the projector is on.
	ISO7010 No. W027 ISO 3864	Warning, light emission (UV, visible light, IR and so on) To indicate that you must be careful not to injure your eyes or skin when near light emitting sections.
	IEC60417 No.5109	Not to be used in residential areas To indicate that the electrical equipment/device is not suitable for use in a residential area.



Glossary

This section briefly explains the difficult terms that are not explained in context in the text of this guide. For details, refer to other commercially available publications.

Aspect Ratio	<p>The ratio between an image's length and its height. Screens with a horizontal:vertical ratio of 16:9, such as HDTV screens, are known as wide screens.</p> <p>SDTV and general computer displays have an aspect ratio of 4:3.</p>
HDCP	<p>HDCP is an abbreviation for High-bandwidth Digital Content Protection. It is used to prevent illegal copying and protect copyrights by encrypting digital signals sent over DVI and HDMI ports. Because the HDMI port on this projector supports HDCP, it can project digital images protected by HDCP technology. However, the projector may not be able to project images protected with updated or revised versions of HDCP encryption.</p>
HDMI™	<p>An abbreviation for High Definition Multimedia Interface. This is the standard by which HD images and multichannel audio signals are digitally transmitted.</p> <p>HDMI™ is a standard aimed at digital consumer electronics and computers. By not compressing the digital signal, the image can be transferred at the highest quality possible. It also provides an encryption function for the digital signal.</p>
HDTV	<p>An abbreviation for High-Definition Television. This refers to high-definition systems which satisfy the following conditions.</p> <ul style="list-style-type: none"> • Vertical resolution of 720p or 1080i or greater (p = Progressive, i = Interlace) • Screen aspect of 16:9 Dolby Digital audio reception and playback (or output)
Interlace	<p>Transmits information needed to create one screen by sending every other line, starting from the top of the image and working down to the bottom. Images are more likely to flicker because one frame is displayed every other line.</p>
Pairing	<p>Register devices in advance when connecting with Bluetooth devices to ensure mutual communication.</p>
SDTV	<p>An abbreviation for Standard Definition Television. This refers to standard television systems which do not satisfy the conditions for HDTV High-Definition Television.</p>
SVGA	<p>A screen size standard with a resolution of 800 (horizontal) x 600 (vertical) dots.</p>
SXGA	<p>A screen size standard with a resolution of 1,280 (horizontal) x 1,024 (vertical) dots.</p>
VGA	<p>A screen size standard with a resolution of 640 (horizontal) x 480 (vertical) dots.</p>
XGA	<p>A screen size standard with a resolution of 1,024 (horizontal) x 768 (vertical) dots.</p>
YCbCr	<p>In component image signals for SDTV, Y is the brightness, while Cb and Cr indicate the color difference.</p>
YPbPr	<p>In component image signals for HDTV, Y is the brightness, while Pb and Pr indicate the color difference.</p>



General Notes

All rights reserved. No part of this publication may be reproduced, stored in a retrieval system, or transmitted in any form or by any means, electronic, mechanical, photocopying, recording, or otherwise, without the prior written permission of Seiko Epson Corporation. No patent liability is assumed with respect to the use of the information contained herein. Neither is any liability assumed for damages resulting from the use of the information contained herein.

Neither Seiko Epson Corporation nor its affiliates shall be liable to the purchaser of this product or third parties for damages, losses, costs, or expenses incurred by the purchaser or third parties as a result of: accident, misuse, or abuse of this product or unauthorized modifications, repairs, or alterations to this product, or (excluding the U.S.) failure to strictly comply with Seiko Epson Corporation's operating and maintenance instructions.

Seiko Epson Corporation shall not be liable against any damages or problems arising from the use of any options or any consumable products other than those designated as Original Epson Products or Epson Approved Products by Seiko Epson Corporation.

The contents of this guide may be changed or updated without further notice.

Illustrations in this guide and the actual projector may differ.

Restriction of Use

When this product is used for applications requiring high reliability/safety such as transportation devices related to aviation, rail, marine, automotive etc.; disaster prevention devices; various safety devices etc; or functional/precision devices etc, you should use this product only after giving consideration to including fail-safes and redundancies into your design to maintain safety and total system reliability. Because this product was not intended for use in applications requiring extremely high reliability/safety such as aerospace equipment, main communication equipment, nuclear power control equipment, or medical equipment related to direct medical care etc, please make your own judgment on this product's suitability after a full evaluation.

Warning Labels

 Warning

- This product comes with warning labels.

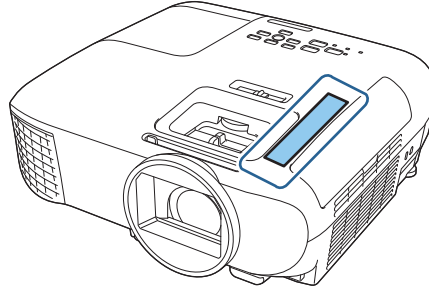

- As with any bright source, do not stare into the beam, RG2 IEC/EN 62471-5:2015.

Disposal

 Caution

Do not disassemble the projector when disposing of it. Dispose of the projector in accordance with your country's regulations or local regulations.

General Notice

"EPSON" is a registered trademark of Seiko Epson Corporation. "EXCEED YOUR VISION" and "ELPLP" are registered trademarks or trademarks of Seiko Epson Corporation.

iPad, iPhone, Mac ,OS X, and iOS are trademarks of Apple Inc.

HDMI, the HDMI Logo and High-Definition Multimedia Interface are trademarks or registered trademarks of HDMI Licensing Administrator, Inc. 

The Bluetooth® word mark and logo are registered trademarks of Bluetooth SIG, Inc., and the Seiko Epson Corporation uses these marks under license. Other trademarks or trade names are the property of their respective owners.

Bluetopia® is provided for your use by Stonestreet One, LLC® under a software license agreement. Stonestreet One, LLC® is and shall remain the sole owner of all right, title and interest whatsoever in and to Bluetopia® and your use is subject to such ownership and to the license agreement. Stonestreet One, LLC® reserves all rights related to Bluetopia® not expressly granted under the license agreement and no other rights or licenses are granted either directly or by implication, estoppel or otherwise, or under any patents, copyrights, mask works, trade secrets or other intellectual property rights of Stonestreet One, LLC®.

© 2000-2012 Stonestreet One, LLC® All Rights Reserved.

Qualcomm aptX is a product of Qualcomm Technologies, Inc. and/or its subsidiaries.

Qualcomm is a trademark of Qualcomm Incorporated, registered in the United States and other countries. aptX is a trademark of Qualcomm Technologies International, Ltd., registered in the United States and other countries.

Wi-Fi® is a registered trademark of the Wi-Fi Alliance.

Netflix is a registered trademark of Netflix, Inc. **NETFLIX**

Google, Android TV™, Chromecast, Google Assistant, YouTube and Google Play are trademarks of Google LLC.

Other product names used herein are also for identification purposes only and may be trademarks of their respective owners. Epson disclaims any and all rights in those marks.

© 2020 Seiko Epson Corporation



Indication of the manufacturer and the importer in accordance with requirements of directive 2011/65/EU (RoHS)

Manufacturer: SEIKO EPSON CORPORATION

Address: 3-5, Owa 3-chome, Suwa-shi, Nagano-ken 392-8502 Japan

Telephone: 81-266-52-3131

<http://www.epson.com/>

Importer: EPSON EUROPE B.V.

Address: Atlas Arena, Asia Building, Hoogoorddreef 5, 1101 BA Amsterdam
Zuidoost The Netherlands

Telephone: 31-20-314-5000

<http://www.epson.eu/>

Supplier's DECLARATION of CONFORMITY

According to 47CFR, Part 2 and 15
Class B Personal Computers and Peripherals; and/or
CPU Boards and Power Supplies used with Class B Personal Computers

We: Epson America, Inc.
Located at: 3131 Katella Avenue, Los Alamitos, CA
Tel: 562-981-3840

Declare under sole responsibility that the product identified herein, complies with 47CFR Part 2 and 15 of the FCC rules as a Class B digital device. Each product marketed, is identical to the representative unit tested and found to be compliant with the standards. Records maintained continue to reflect the equipment being produced can be expected to be within the variation accepted, due to quantity production and testing on a statistical basis as required by 47CFR 2.906. Operation is subject to the following two conditions : (1) this device may not cause harmful interference, and (2) this device must accept any interference received, including interference that may cause undesired operation.

Trade Name: EPSON
Type of Product: LCD Projector
Model: HA11C/HA12C

**FCC Compliance Statement
For United States Users**

This device complies with part 15 of the FCC Rules. Operation is subject to the following two conditions: (1) This device may not cause harmful interference, and (2) this device must accept any interference received, including interference that may cause undesired operation.

This equipment has been tested and found to comply with the limits for a Class B digital device, pursuant to Part 15 of the FCC Rules. These limits are designed to provide reasonable protection against harmful interference in a residential installation. This equipment generates, uses, and can radiate radio frequency energy and, if not installed and used in accordance with the instructions, may cause harmful interference to radio communications.

However, there is no guarantee that interference will not occur in a particular installation. If this equipment does cause harmful interference to radio or television reception, which can be determined by turning the equipment off and on, the user is encouraged to try to correct the interference by one or more of the following measures.

- Reorient or relocate the receiving antenna.
- Increase the separation between the equipment and receiver.
- Connect the equipment into an outlet on a circuit different from that to which the receiver is connected.
- Consult the dealer or an experienced radio/TV technician for help.

WARNING

The connection of a non-shielded equipment interface cable to this equipment will invalidate the FCC Certification or Declaration of this device and may cause interference levels which exceed the limits established by the FCC for this equipment. It is the responsibility of the user to obtain and use a shielded equipment interface cable with this device. If this equipment has more than one interface connector, do not leave cables connected to unused interfaces. Changes or modifications not expressly approved by the manufacturer could void the user's authority to operate the equipment.

3

3D brightness	51
3D display	51
3D format	51
3D Glasses	45
3D images	44
3D setup	51
3D viewing notice	51

A

A/V mute	32
Adjust lens shift	7
Adjusting focus	27
Adjusting RGB	38
Adjusting the position of the image	28
Adjusting the tilt	28
Advanced	50, 52
Air filter	69, 72
Air filter cover	70, 72
Air filter replacement period	71
Appearance	83
Aspect	33, 51
Auto iris	35, 51
Auto V-Keystone	29

B

Bluetooth	53
Brightness	39, 50

C

CEC standards	47
Child lock	53
Cleaning the air filter	69
Cleaning the lens	71
Cleaning the main unit	70
Color depth	55
Color mode	33, 50
Color saturation	50
Configuration menu	49
Connecting	20
Connecting a computer	20
Connecting Bluetooth devices	20
Connecting external equipment	20
Connecting external speakers	22
Connecting video equipment	20
Contrast	50
Control panel	7, 8
Control panel lock	53
Cool-down	26

D

Detail Enhancement	50
Detail enhancement	35
Direct power on	55
Display	54
Display background	54

E

EDID	52
Error/Warning indicators	57
Extended menu	54

F

Focus	62
Focus adjuster	7
Focus adjustment	27
Focus ring	27
Frame interpolation	36, 50
Full	33

G

Gain	38, 50
Gamma	40, 50

H

H/V-Keystone	29
HDMI link	47, 53
HDMI port	9, 47
Height adjustment	27
High altitude mode	55
H-Keystone adjuster	29
Horizontal keystone adjuster	8
Hue	39, 50

I

Illumination	55
Image	33
Image enhancement	35
Image menu	50
Image Preset Mode	50
Image preset mode	35
Image processing	36, 52
Indicators	57
Info menu	55
Inverse 3D glasses	51

K

Keystone	52
Keystone distortion	29, 52

- L**
- Lamp cover 7, 73
 - Lamp cover fixing screw 73
 - Lamp hours 55
 - Lamp replacement period 71
 - Language 55
 - Lens shift dial 28
 - Load memory 43
 - Lock setting 53
- M**
- Memory 54
 - Memory function 42
 - Menu 49
 - Messages 54
 - MPEG noise reduction 35
 - Mute 32
- N**
- Noise 62
 - Noise Reduction 50
 - Noise reduction 35
- O**
- Offset 38, 50
 - Operating range 24
 - Operating time 56, 74
 - Operation 55
 - Overscan 51
- P**
- Pairing 23
 - Power 26
 - Power consumption 51
 - Power supply 25
 - Projection 54
 - Projection size 27
 - Projector info 55
 - Projector remote control 11
- Q**
- Quick Corner 30
- R**
- Remote control 11, 23
 - Remote control for Android TV 12
 - Replacement periods for consumables 71
 - Replacement time 71
 - Replacing consumables 72
 - Replacing the air filter 72
 - Replacing the lamp 72
 - Reset 51, 52, 54, 55
 - Reset all config 56
 - Reset lamp hours 56, 74
 - Reset memory 56
 - Reset menu 56
 - RGBCMY 39, 50
- S**
- Saturation 39, 50
 - Save memory 42
 - Settings menu 52
 - Sharpness 34, 50
 - Signal menu 51
 - Sleep mode 55
 - Source 26
 - Specifications 81
 - Startup screen 54
 - Sub menu 49
 - Supported resolutions 78
- T**
- Tint 50
 - Top menu 49
- V**
- Version 55
 - Volume 32, 52
- W**
- White balance 50
- Z**
- Zoom 33
 - Zoom adjuster 7, 27
 - Zoom adjustment 27